

Uponor MLC tap water and heating

EN Technical information



Table of contents

1	Uponor MLC Tap water and heating.....	4	8	Pipe network calculations according to DIN 1988-300....	40
1.1	System description.....	4	8.1	General information.....	40
1.2	Component overview - pipes.....	4	8.2	Planning reliability with Uponor HSE.....	40
1.3	Component overview - jointing technology.....	5	8.3	Data for pipe network calculations.....	41
1.4	Component overview - tools.....	6			
2	Uponor composite pipes.....	7	9	Leak test, initial filling and commissioning.....	47
2.1	Uponor Uni Pipe PLUS	7	9.1	Pressure and leak testing.....	47
2.2	Uponor MLC pipe.....	7	9.2	Flushing of Uponor drinking water distribution.....	48
2.3	Temperature ranges.....	8			
2.4	Insulated Uponor composite pipes.....	8	10	Handover and documentation.....	49
3	Jointing technology for Uponor composite pipes.....	10	11	Heating installation.....	50
3.1	Fitting systems - overview.....	10	11.1	System description.....	50
3.2	Uponor S-Press PLUS - a new generation of fittings.....	11	11.2	Uponor main components for heating (overview).....	50
3.3	Uponor S-Press PLUS - design.....	12	11.3	Planning principles for heating installation.....	52
3.4	Uponor S-Press PLUS - fitting/tool combinations.....	13	11.4	Examples of radiator connections.....	53
3.5	Uponor S-Press PLUS - fitting assembly.....	13	11.5	Data for pipe network calculations.....	60
3.6	Uponor S-Press PPSU fittings up to 75 mm.....	14			
3.7	Other fittings for Uponor composite pipes.....	16	12	Pressure and leak testing of Uponor heating installations.....	91
4	Drinking water distribution.....	22	12.1	Leak test for heating installations with water.....	91
4.1	System description.....	22	12.2	Leak test for heating installation with compressed air or inert gas.....	91
4.2	The tap water connection system from Uponor.....	22			
4.3	Main tap water components.....	23	13	General planning principles.....	92
5	Uponor Smatrix Aqua PLUS.....	27	13.1	Fire protection requirements.....	92
5.1	System description.....	27	13.2	Pipe insulation.....	92
5.2	Uponor Smatrix Aqua PLUS flushing unit.....	27			
5.3	Function description.....	29	14	Pressing tools for fitting assembly.....	93
6	Hot water generation.....	30	14.1	System description.....	93
6.1	Uponor decentralised heat interface units.....	30	14.2	Uponor pressing tool concept.....	94
6.2	Comparing a 2- and 4-pipe system.....	31	14.3	Overview tools for fitting assembly.....	95
6.3	General technical information.....	32	14.4	List of recommendations.....	96
6.4	Main operating principles.....	33	15	General processing instructions.....	98
6.5	Variants of Uponor heat interface units.....	34	15.1	Installation instructions.....	98
7	Planning principles for water distribution.....	35	15.2	Installation according to Z dimension.....	99
7.1	General information.....	35	15.3	Consideration of thermal length expansion.....	99
7.2	Installation variants.....	36	15.4	Cellar distribution and riser pipes.....	100
7.3	Circulation systems.....	37	15.5	Determination of the bending leg length.....	101
7.4	Use of trace heating.....	38	15.6	Bending Uponor composite pipes.....	101
7.5	Connections.....	38	15.7	Fixation distances.....	102
7.6	Moisture protection.....	38	15.8	Pipeline laying on the raw floor.....	102
			15.9	Installation under mastic asphalt.....	103

16	Transport, storage and processing conditions.....	105
16.1	General information.....	105
16.2	Processing temperatures.....	105
16.3	Uponor composite pipes.....	105
16.4	Uponor fittings.....	105
16.5	Installation in the ground and outdoors.....	105
17	System compatibility.....	106
17.1	Transitions from Unipipe old installations.....	106
18	Calculation/assembly times.....	107
18.1	Assembly time per running meter or fitting.....	107
18.2	Assembly time per modular Uponor RS fitting.....	107
19	Risk of mixed installation.....	108
19.1	Installation configurations.....	108

1 Uponor MLC Tap water and heating

1.1 System description



Note

This publication includes information (text and images) about products that may not be available in all markets.

For detailed information on the range of components in each local market, see the price lists.

Whether drinking water distribution or radiator connection – the Uponor composite pipe system is the perfect solution. The complete programme enables the complete installation from the riser to the consumer. Installation is particularly simple and economical. The core components of the system, the Uponor composite pipe and its associated fittings, are developed and manufactured in-house and are therefore perfectly matched to one another. Due to the form stability of the pipe and its low linear expansion, only a few fixing points are required – the practical advantage for reliable, quick installation. The Uponor composite pipe system is rounded off by a sophisticated range of tools.

Uponor composite pipe system

- Pipe dimensions from 14 to 110 mm for any property size
- One pipe – many suitable fitting technologies for different installation tasks
- Form stability and length expansion similar to metal pipes
- Comprehensive quality control during production for maximum safety in the installation
- Ideal for surface and in-wall mounting
- Comprehensive, practical delivery programme for every installation requirement

1.2 Component overview - pipes

Uponor Uni Pipe PLUS



Absolutely oxygen-diffusion-tight 5-layer composite pipe for drinking water distribution and heating applications

- Seamless aluminium layer using SAC technology
- DVGW approved for drinking water distribution
- Removable hygienic closure according to DIN EN 806
- Minimum bending radii
- Pipe stiffness optimised for wall surface mounting
- Dimensions 14 – 32 mm

Uponor MLC composite pipe

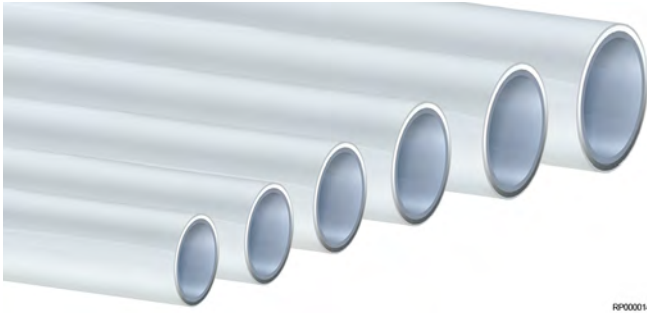

RP0000145

Absolutely oxygen-diffusion-tight 5-layer composite pipe for drinking water distribution and heating applications

- Safety-welded aluminium layer
- DVGW approved for drinking water distribution
- Removable hygienic closure according to DIN EN 806
- Dimensions 40 – 110 mm

Insulated Uponor Uni Pipe PLUS pipes

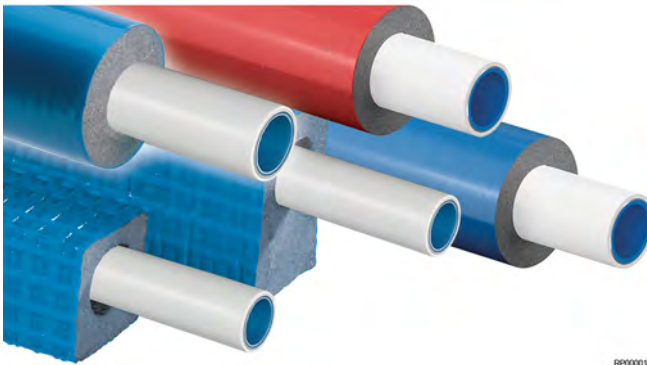

RP0000146

Uponor composite pipes drawn into thermal insulation at the factory

- Round extruded pipe insulation made of closed cell polyethylene foam and hard-wearing film coating for different insulation requirements
- Pipe insulation S4 in red and blue, for optimum differentiation in the hygienically favoured loop installation.
- Alternatively also available as pre-insulated heating pipes with asymmetrical insulation in accordance with EnEV (German Energy Saving Ordinance)

Uponor Uni Pipe PLUS pipes in conduit

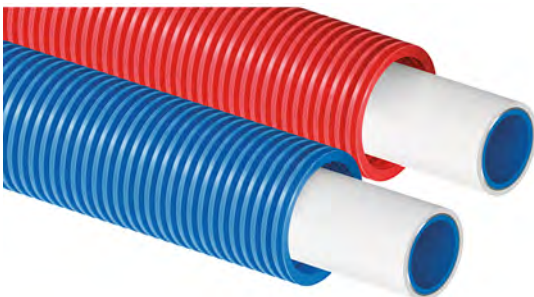

RP0000147

Uponor composite pipes drawn into HDPE protective tubes at the factory

- Colour differentiation between supply and return (red) and heating return (blue)
- Uponor Teck protective tubes are also available separately in blue, red and black

1.3 Component overview - jointing technology

Uponor S-Press PLUS fittings



RP0000148

Press fitting for Uponor Uni Pipe PLUS composite pipes in tap water and heating installations

- Fitting made of dezincing resistant brass or PPSU
- Flow-efficient design for low zeta values
- Fixed stainless steel sleeve with press jaw guide
- "Unpressed-untight" test safety
- Foil on stainless steel sleeve with 3-way function: Press indicator, colour coding and printed QR code for additional information
- Dimensions 16 – 32 mm

Uponor S-Press fittings



RP0000149

Press fitting for Uponor MLC composite pipes in tap water and heating installations

- Fitting made of brass or PPSU
- Fixed stainless steel sleeve
- "Unpressed-untight" test safety
- Dimension-specific colour coding using coloured stop rings
- Dimensions 14 mm, 40 – 75 mm

Uponor RTM fittings



Fitting made of PPSU or brass with integrated pressing function, press indicator and colour coding, dimensions 16 – 25 mm

Uponor RS fitting system



Modular fitting system consisting of basic parts and press adapters for distribution and riser pipes 63 – 110 mm.

Uponor S-Press/S-Press PLUS system adapters



Uponor S-Press/S-Press PLUS side with fixed press sleeve, test reliability "unpressed-untight" as well as press indicator and colour coding. Stainless steel/copper side processed according to the specifications of the specific metal system supplier

Uponor Uni



System accessories as well as screw connections and system components with 1/2" (Uni-C) or 3/4" (Uni-X) threaded connections

1.4 Component overview - tools

Tools for composite pipe processing



Pressing tools and press jaws as well as cutting, bending and calibration tools for processing the Uponor composite pipe system in tap water and heating installations.

2 Uponor composite pipes

2.1 Uponor Uni Pipe PLUS



by up to 40 % compared to conventional composite pipes – that means fewer pipe fixing points are required during installation and many changes in direction can be achieved with pipe bends. That reduces the number of fittings and pipe clamps required and also saves assembly time.

Uponor Uni Pipe PLUS

- Seamless for maximum safety
- High form stability and minimal expansion
- Improved bending properties
- 100 % oxygen-tight
- Low weight
- Dimensional range 14 – 32 mm
- Large mounting distances without clips

Uponor Uni Pipe PLUS is the unique composite pipe with no weld seam, which increases fixing distances and reduces the bending radii

Technical data and delivery dimensions

Pipe dimension [mm]	14 x 2.0	16 x 2.0	20 x 2.25	25 x 2.5	32 x 3.0
Inner diameter ID [mm]	10	12	15.5	20	26
Coil length [m]	200	10/25/100/120/200/500	25/100/500	50	50
Bar length [m]	-	3/5	3/5	3/5	3/5
Outer diameter of coil [cm]	80	80/80/78/78/80/114	80/80/114	114	114
Weight of coil/bar [g/m]	91/-	111/119	161/171	233/247	364/394
Weight of coil/bar with water at 10 °C [g/m]	170/-	224/232	350/360	547/560	895/926
Weight per coil [kg]	18.2	1.1/2.8/11.1/14.3/23.8/59.5	4/16.1/80.5	11.65	18.2
Weight per bar [kg]	-	0.35/0.59	0.52/0.86	0.74/1.24	1.18/1.97
Water volume [l/m]	0.079	0.113	0.189	0.314	0.531
Pipe roughness k [mm]	0.0004	0.0004	0.0004	0.0004	0.0004
Thermal conductivity λ [W/mK]	0.40	0.40	0.40	0.40	0.40
Coefficient of expansion α [m/mK]	25 x 10 ⁻⁶	25 x 10 ⁻⁶	25 x 10 ⁻⁶	25 x 10 ⁻⁶	25 x 10 ⁻⁶

2.2 Uponor MLC pipe

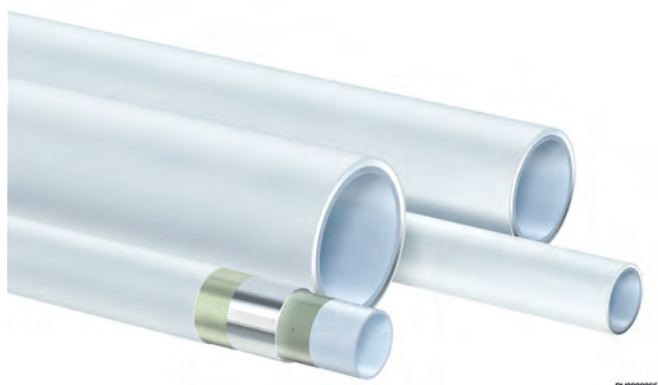

The Uponor MLC composite pipe is used in particular as distribution and riser pipes in drinking water distribution and heating/cooling applications. Uponor MLC = Multilayer composite pipes are easy to process, corrosion-free and can be used for a variety of installation tasks, even in larger residential and commercial properties.

Uponor MLC

- Safety-welded aluminium layer
- High form stability
- Corrosion-free and sound-proofing
- Fast installation without soldering or welding
- 100 % oxygen-tight
- Dimensional range 40 – 110 mm

Technical data and delivery dimensions

Pipe dimension [mm]	40 x 4.0	50 x 4.5	63 x 6.0	75 x 7.5	90 x 8.5	110 x 10.0
Inner diameter ID [mm]	32	41	51	60	73	90
Coil length [m]	-	-	-	-	-	-
Bar length [m]	3/5	3/5	3/5	5	5	5
Outer diameter of coil [cm]	-	-	-	-	-	-
Weight of coil/bar [g/m]	-/508	-/745	-/1224	-/1788	-/2545	-/3597
Weight of coil/bar with water at 10 °C [g/m]	-/1310	-/2065	-/3267	-/4615	-/6730	-/9959
Weight per coil [kg]	-	-	-	-	-	-
Weight per bar [kg]	1.52/2.54	2.24/3.73	3.67/6.12	8.94	12.73	17.99
Water volume [l/m]	0.800	1.320	2.040	2.827	4.185	6.362
Pipe roughness k [mm]	0.0004	0.0004	0.0004	0.0004	0.0004	0.0004
Thermal conductivity λ [W/mK]	0.40	0.40	0.40	0.40	0.40	0.40
Coefficient of expansion α [m/mK]	25×10^{-6}	25×10^{-6}	25×10^{-6}	25×10^{-6}	25×10^{-6}	25×10^{-6}

2.3 Temperature ranges

Tap water: The permissible continuous operating temperature is between 0 and 70 °C at a maximum continuous operating pressure of 10 bar. The momentary fault temperature is 95 °C for a maximum operating time of 100 hours.

Heating: The permissible maximum continuous operating temperature is 80 °C at a maximum continuous operating pressure of 10 bar. The momentary fault temperature is 100 °C for a maximum operating time of 100 hours.

2.4 Insulated Uponor composite pipes



PH0000066

Uponor composite pipes are also available in conduit or with factory thermal insulation to avoid damage and heat loss.

For better differentiation between cold and warm distribution pipes in series and loop installations Uponor composite pipes are also available insulated with red and blue insulation S4 WLS 040.

Factory insulated Uponor installation pipes offer decisive advantages over pipes insulated on site. On the one hand, they ensure rapid construction progress and at the same time they ensure that the insulation suitable for the specific insulation requirement will be used. The good thermal insulation properties of the insulation materials used allow small outside pipe diameters with optimum thermal insulation. By using asymmetrically insulated heating pipes in the floor structure, the required installation height can also be considerably reduced compared to comparable all-round insulation. This rectangular insulation can also be better integrated into the distribution insulation.

Insulated Uponor composite pipes

- Seamless or OWC-technology for highest level of safety
- Time savings on site compared to on-site insulation
- Thermal insulation according to EnEV and DVGW requirements
- Robust surface to protect against damage

Preinsulated Uponor Uni Pipe PLUS composite pipes

Insulation class WLS 040

Pipe OD x material thickness [mm]	In all-round insulation, thickness [mm]										In asymmetrical insulation, thickness [mm]				In conduit	
	4	OD ¹⁾	6	OD ¹⁾	9	OD ¹⁾	10	OD ¹⁾	13	OD ¹⁾	9	W x H ²⁾	26	W x H ²⁾		
14 x 2.0	•		•	26												
16 x 2.0	•	24	•	28	•	34				•	42	•	31 x 34	•	38 x 55	•
20 x 2.25	•	28	•	32	•	38				•	46	•	35 x 38	•	39 x 59	•
25 x 2.5	•	33	•	37	•	43				•	51					•
32 x 3.0	•	40			•	50										

1) Outer diameter (OD) [mm]

2) Width x height [mm]

Insulation class WLS 035

Pipe OD x material thickness [mm]	In all-round insulation, thickness [mm]										In asymmetrical insulation, thickness [mm]				In conduit
	4	OD ¹⁾	6	OD ¹⁾	9	OD ¹⁾	10	OD ¹⁾	13	OD ¹⁾	9	W x H ²⁾	26	W x H ²⁾	
16 x 2.0			•	28			•	36							
20 x 2.25			•	32			•	40							
25 x 2.5			•	37			•	45							

1) Outer diameter (OD) [mm]

2) Width x height [mm]

3 Joining technology for Uponor composite pipes

3.1 Fitting systems - overview

Differing installation situations and areas of application demand customised, precisely adapted fitting design concepts. This is why Uponor develops and produces not only pipes, but also the appropriate fitting systems tailored to the respective application. The Uponor fitting range with couplings, elbows, T-joints and a large

number of practical system components creates the prerequisites for fast, safe and practical installation and exceeds the requirements placed on hygienic drinking water distribution and modern heating piping.

Overview of the Uponor composite pipe fitting systems

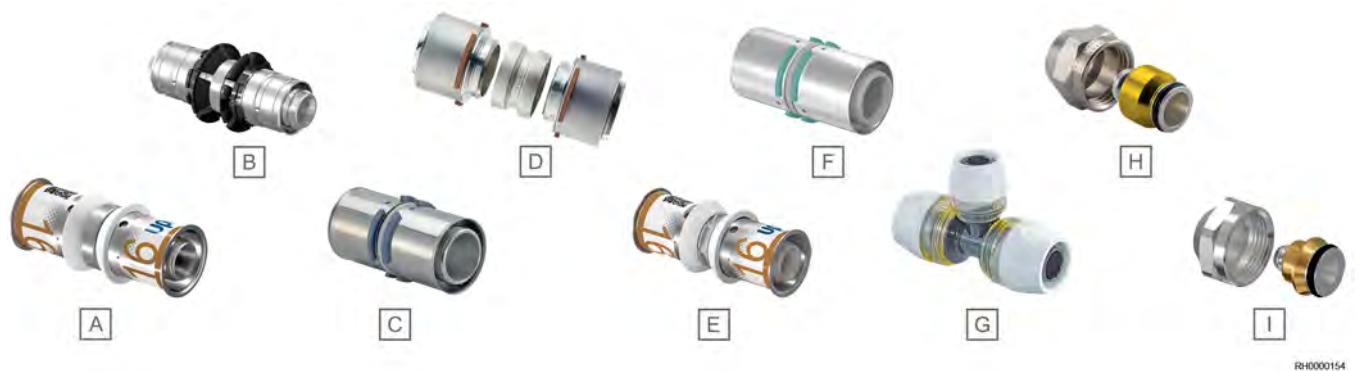

Uponor fitting system		Press fitting, metal				Press fitting, composite		RTM fitting	Uni-C 1/2"	Uni-X 3/4"
		S-Press PLUS	S-Press		RS	S-Press PLUS	S-Press			
Colour code/ dimension	Pipe type	A	B	C	D	E	F	G	H	I
	14 Uni Pipe PLUS		•						•	•
	16 Uni Pipe PLUS	•			•	•		•	•	•
	20 Uni Pipe PLUS	•			•	•		•	•	•
	25 Uni Pipe PLUS	•			•	•		•		•
	32 Uni Pipe PLUS	•			•	•				
	40 MLC			•	•		•			
	50 MLC			•	•		•			
	63 MLC			•	•		•			
	75 MLC			•	•		•			
	90 MLC				•					
	110 MLC				•					

Properties

Uponor fitting system	Press fitting, metal				Press fitting, composite		RTM fitting	Uni-C 1/2"	Uni-X 3/4"
	S-Press PLUS	S-Press		RS	S-Press PLUS	S-Press			
	A	B	C	D	E	F			
Dimension-specific colour coding	•	•	•	•	•	•	•		
Inspection window for checking insertion depth	•	•	•	•	•	•	•		

Uponor fitting system	Press fitting, metal				Press fitting, composite		RTM fitting	Uni-C ½"	Uni-X ¾"
	S-Press PLUS	S-Press		RS	S-Press PLUS	S-Press			
	A	B	C	D	E	F	G	H	I
Press indicated by detachment of the foil from the press sleeve	•				•				
Press indicated by removal of the stop ring		•		• ¹⁾					
Press indicated by press imprint on press sleeve	•		•	• ²⁾	•	•			
Assembly without deburring	•	•		• ¹⁾	•		•	•	•
Mounting without calibration	•	•	•	•	•	•		•	•
Connector unpressed, untight	•	•	•	•	•	•			
Integrated pressing function							•		
Modular fitting system				•					

¹⁾ Up to a dimension of 32 mm

²⁾ Dimension 40 mm and up

3.2 Uponor S-Press PLUS - a new generation of fittings



RP0000155

Sturdy press sleeves made of stainless steel

Stainless steel press sleeves firmly attached to the fitting protect the O-rings from damage and give the finished connection high pull-out and bending resistance.

High-quality materials

Fittings made of dezincing resistant brass according to the UBA positive list and alternatively made of the high-performance plastic PPSU allow unrestricted use in tap water and heating installations.

Precise press jaw guidance and insertion control

The special shape of the press sleeves and the newly designed stop rings ensure precise positioning of the Uponor press jaws. Inspection windows in the stainless steel press sleeves make it easy to check the depth to which the pipe is inserted before pressing.

Dimension-specific colour coding

The colour coding and clearly legible figures of the different dimensions are easy to recognise even from a great distance and in difficult lighting conditions.

Unique pressing control and test safety

The stainless steel press sleeves are sheathed with a colour-coded foil depending on the dimensions, which can be easily removed after pressing and thus offers a double pressing control in addition to the "unpressed-untight" function.

Flow-optimised design

The streamlined design ensures low zeta values and enables pressure loss optimised planning.

Fast and simple installation

Just three steps to the finished connection without deburring or calibrating: Cut, stick, press. The slim design of the finished connection also makes subsequent insulation easier.

100 % compatible with existing Uponor components

Uponor S-Press PLUS fittings are matched to the existing Uponor composite pipe system.

Simple adjustment

The installation can still be adjusted until completion of pressing. But even after the pressing process, the pipes can still be straightened until completion of the pressure test.

Online information available via QR code

The printed QR code provides 24/7 access to installation support, project database, item lists and online orders.

Certificates, few examples

- DVGW
- ÖVGW
- KIWA/KOMO

3.3 Uponor S-Press PLUS - design

Uponor S-Press PLUS composite fittings made of PPSU

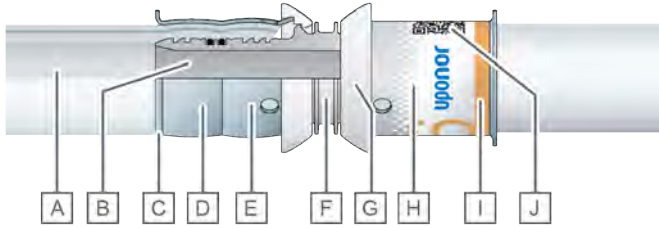

ED0000022

Item	Description
A	Uponor MLC or Uni Pipe PLUS composite pipe 16 – 32 mm
B	Flow-optimised design
C	Sleeve collar for press jaw centring
D	Stainless steel press sleeve
E	Inspection window for insertion depth
F	Fitting body made of PPSU
G	Press jaw stop
H	Press indicator film
I	Colour-coded dimensional marking
J	QR code for additional information

Uponor S-Press PLUS made of dezincing resistant brass

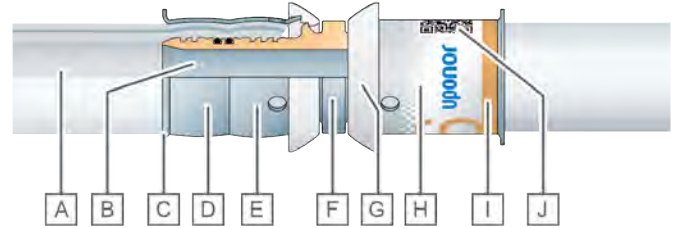

ED0000023

Item	Description
A	Uponor MLC or Uni Pipe PLUS composite pipe 16 – 32 mm
B	Flow-optimised design
C	Sleeve collar for press jaw centring
D	Stainless steel press sleeve
E	Inspection window for insertion depth
F	Fitting body made of dezincing resistant brass
G	Press jaw stop
H	Press indicator film
I	Colour-coded dimensional marking
J	QR code for additional information

Flow-optimised fitting design

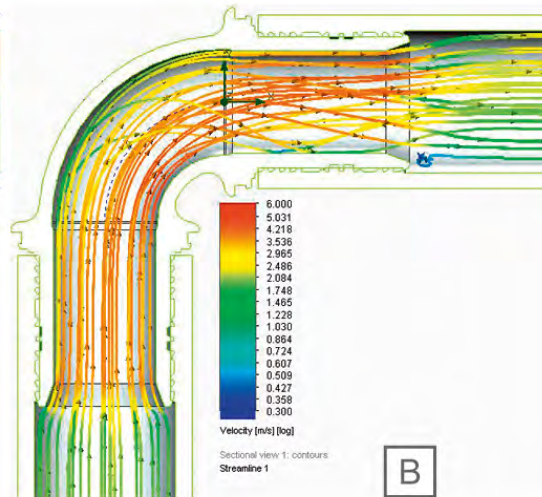
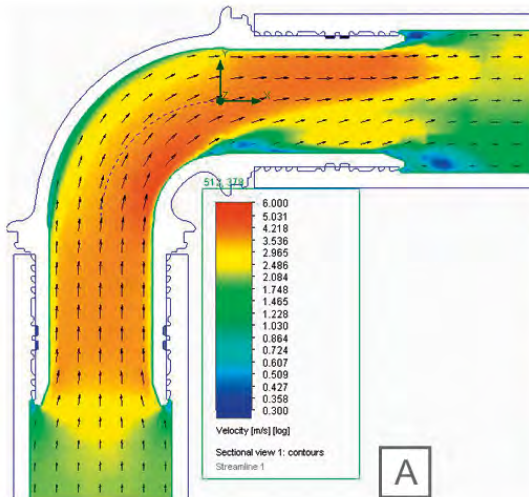

ED0000024

Velocity [m/s] [log], View	Value
A	Sectional view 1: contours
B	Streamline 1

The S-Press PLUS radial press jointing technology is designed to be free of dead space, avoiding any risk of contamination due to stagnating water inside the fitting. Proven by microbiological tests at the Institute for Environmental Hygiene and Toxicology in Gelsenkirchen.

3.4 Uponor S-Press PLUS - fitting/tool combinations



Item	Description
A	Manual pressing tool
B	Interchangeable inserts
C	UP 110, battery tool
D	UP 75 EL, electrical tool 230 V
E	UPP1, pressing jaw

Item	Description
F	Mini2, battery tool
G	Mini KSP0, pressing jaw
H	S-Press PLUS/S-Press PLUS PPSU fitting dimensions in mm

3.5 Uponor S-Press PLUS - fitting assembly

Insert the Uponor composite pipe into the fitting



Insert the Uponor composite pipe into the fitting. The pipe end does not have to be deburred or calibrated beforehand.

Apply the press jaw



Apply the press jaw with the same colour coding as the fitting to the press jaw guide in the stainless steel press sleeve.

The film can be easily removed after successful pressing



After pressing, a clear deformation of the stainless steel press sleeve is visible. In addition, the film can be easily removed after successful pressing (visual inspection).

Unpressed connections are reliably detected



Unpressed connections are reliably detected as leaky during the leak test due to the unpressed-untight function. An unpressed fitting also stands out clearly due to the indicator foil still being present on the stainless steel press sleeve.

3.6 Uponor S-Press PPSU fittings up to 75 mm







We have extended the dimensional range of our Uponor S-Press PPSU fittings with 63 mm and 75 mm, especially for economical drinking water distribution and heating installations in commercial buildings. Uponor S-Press composite fittings made of the high performance plastic PPSU are light, impact resistant and have very low stress crack sensitivity.

For the direct thread transition there are also 40 — 75 mm tin-plated S-Press adapter sleeves and S-Press adapter nipples made of dezincing resistant brass.

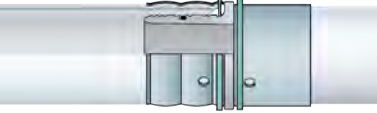
As a supplement to the modular Uponor RS fitting system and in conjunction with the tried and tested Uponor MLC composite pipes, it is now possible to realise pipe networks, including distribution and riser pipes, that are easy to install and cost-effective.

Uponor S-Press PPSU fitting 40 — 75 mm

Dimensional range	Description/properties	Material	Colour code/ dimension
 <p>40 — 75 mm</p>	<ul style="list-style-type: none"> "Unpressed-untight" test safety. Dimension-specific colour coding of the stop rings. Press sleeve firmly connected to the fitting protects the O-rings from damage. Press sleeve with inspection windows for easy checking of the insertion depth of the pipe before pressing. The pipe can be aligned after pressing (until completion of the pressure test). High pull-out and bending strength for the finished joint. 	<ul style="list-style-type: none"> Fitting made of PPSU Press sleeve made of stainless steel Coloured plastic stop elements 	 40
			 50
			 63
			 75

Uponor S-Press PPSU 40 — 75 mm - fitting/tool combinations



Item	Description
A	UP 110, battery tool
B	UPP1, pressing jaw
C	UP 75 EL, electrical tool 230 V
D	Basic press jaw with press chain
E	S-Press PPSU fitting dimensions in mm

Uponor S-Press PPSU - fitting assembly with press chain

Insert the deburred composite pipe end



Insert the deburred composite pipe end into the fitting as far as it will go. Then place the appropriate press chain (same dimension and same colour code as fitting) around the press sleeve up to the coloured stop.

Hook the base press jaw into the press chain



Hook the base press jaw into the press chain and trigger pressing.

A clear deformation of the press sleeve



After pressing, the successful pressing is visible by a clear deformation of the press sleeve (visual inspection).

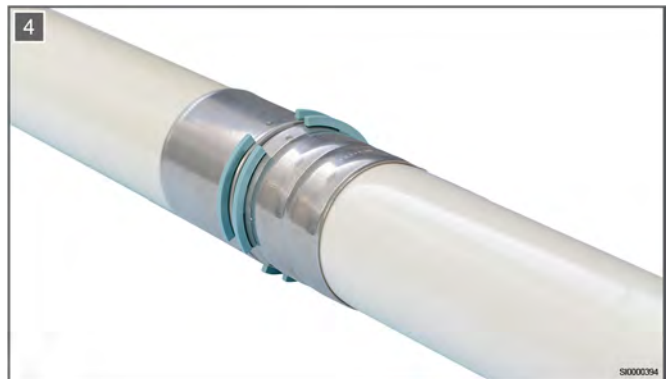

An unpressed connection leaks





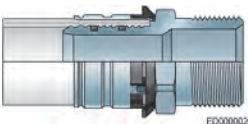

For additional safety, an unpressed connection leaks under pressure load (unpressed-untight function).

3.7 Other fittings for Uponor composite pipes

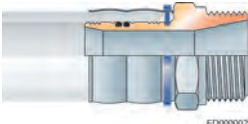
Uponor S-Press metal fittings, dimension overview

Dimensional range	Description/properties	Material	Colour code/ dimension
 <p>14 mm</p>	<ul style="list-style-type: none"> "Unpressed-untight" test safety. Dimension-specific colour coding of the stop rings. Pressing control by means of coloured stop rings, which become detached during the pressing process. Press sleeve firmly connected to the fitting protects the O-rings from damage. Press sleeve with inspection windows for easy checking of the insertion depth of the pipe before pressing. The pipe can be aligned after pressing (until completion of the pressure test). High pull-out and bending strength for the finished joint. Pressing without deburring. 	<ul style="list-style-type: none"> Brass, tin-plated Profiled aluminium press sleeve Coloured plastic stop rings 	 14

Dimensional range	Description/properties	Material	Colour code/ dimension
 <p>40 — 75 mm</p>	<ul style="list-style-type: none"> "Unpressed-untight" test safety. Dimension-specific colour coding of the stop rings. Press sleeve firmly connected to the fitting protects the O-rings from damage. Press sleeve with inspection windows for easy checking of the insertion depth of the pipe before pressing. The pipe can be aligned after pressing (until completion of the pressure test). High pull-out and bending strength for the finished joint. 	<ul style="list-style-type: none"> Brass, tin-plated Press sleeve made of stainless steel Coloured plastic stop elements 	 40  50  63  75

Uponor S-Press and S-Press PLUS system adapters

Note

When processing different third-party system fitting sides, the specifications of the specific manufacturer or system supplier must be observed.



The Udonor S-Press/S-Press PLUS system adapters are the ideal solution for a standard-compliant transition to an existing metallic pipe system, particularly when it comes to renovation or system expansion. The fitting side for connecting to metal pipes with standard dimensions is processed according to the manufacturer's specifications using the corresponding tools and press jaws. The Udonor S-Press/S-Press PLUS side is simply and securely connected to the Udonor composite pipe and the corresponding Udonor press jaw.

Uponor RS fitting system for distribution lines and risers



The modular Udonor RS fitting system for distribution and riser pipes lets you make all required press joints safely and easily on the workbench. Only here are heavy tools needed to press the connections. On site, the pre-assembled composite pipe sections are then inserted into the fittings without tools and locked.

This ensures fast and safe installation even under the most difficult spatial conditions. Difficult work with heavy pressing tools in cramped construction site situations or in overhead positions is a thing of the past.





Udonor RS is a unique fitting system for risers and other supply lines used in tap water and heating/cooling applications. Thanks to the modular concept, hundreds of fitting variants can be produced with only a few system components.

Uponor RS fitting system - benefits

- Innovative plug-in connection of base bodies and adapters for Uponor multilayer pipes up to 110 mm
- Only a few components allow many fitting variants

- Efficient stocking
- Adjustable until completion of the leak test
- Dimension-specific colour coding

Uponor RS fittings, dimension overview

Dimensional range	Description/properties	Material	Colour code/ dimension
 63 — 110 mm	<ul style="list-style-type: none"> • "Unpressed-untight" test safety. • Dimension-specific colour coding of the stop rings. • Modular range of fittings, consisting of matching base bodies and press adapters. • Press adapters with fixed stainless steel press sleeves can be conveniently pressed to the Uponor composite pipes away from the installation location, e.g. directly at the workbench. • In the second step, the pre-assembled press adapters are inserted into the respective base bodies on site and fastened using a locking element for a secure connection. 	<ul style="list-style-type: none"> • Brass, tin-plated • Press sleeve made of stainless steel • Coloured plastic stop element • Plastic locking element 	 63
			 75
			 90
			 110

Flexible main manifold structure



Flexible main manifold structure – with the modular fitting system and the associated distance adapters, manifolds of different sizes can be manufactured flexibly in just a few simple steps.

Flexible angles – walls and ceilings are often not perpendicular to each other, especially in old buildings. Using distance adapters (5 mm) in conjunction with two 45° angles, any desired angle can be achieved just by turning the components.

Distance adapters



Simple and quick changes to pipeline levels – using distance adapters in combination with 45° angles, level changes are possible with only minimal height differences.

Fixed points



Fixed points are often required in pipeline systems with long supply sections. Distance adapters (RS2/RS3) allow these to be created quickly and easily. The circumferential bars in the middle of the distance adapters facilitate the fastening of fixed point clamps.

The modular RS principle

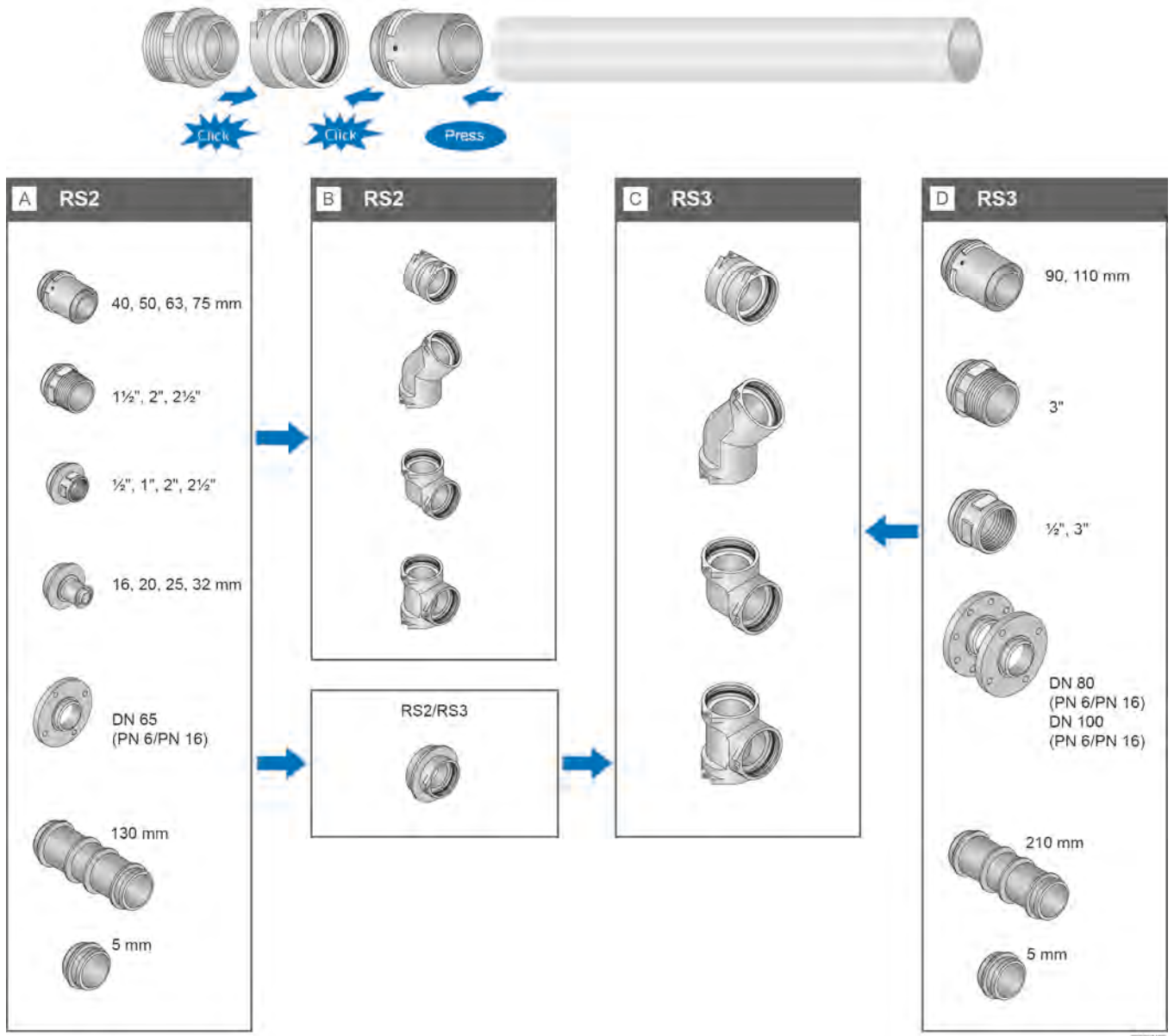

Item	Description
A	RS2 Adapter
B	RS2 Base Body

Item	Description
C	RS3 Base Body
D	RS3 Adapter

Configuration examples

T-piece with outlets

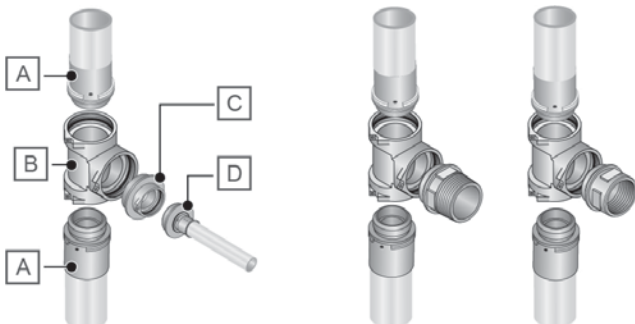

Item	Description
A	RS Press adapter
B	RS T-piece
C	Adapter RS3/RS2
D	RS Press adapter 16 — 75 mm

Angle 90° or 45°

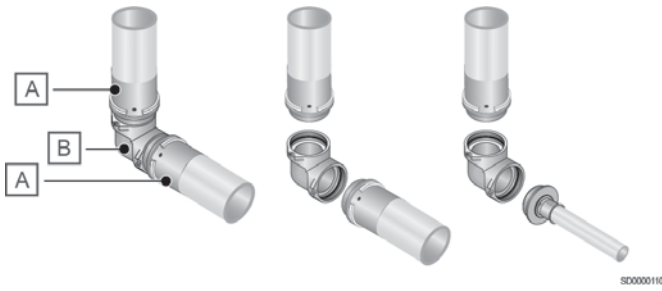

Item	Description
A	RS Press adapter
B	RS angle 90°

Thread adapters

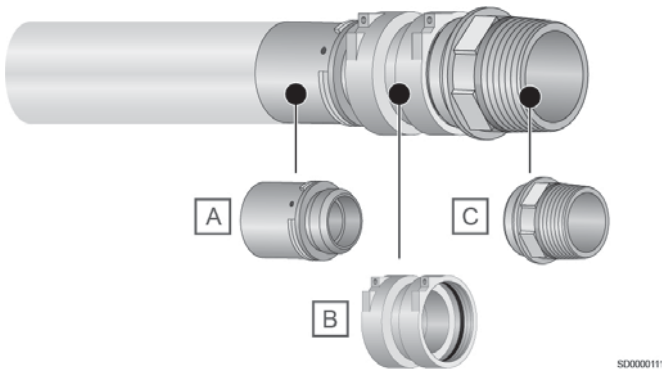

Item	Description
A	RS Press adapter
B	RS coupling
C	RS thread adapter AG

Couplings

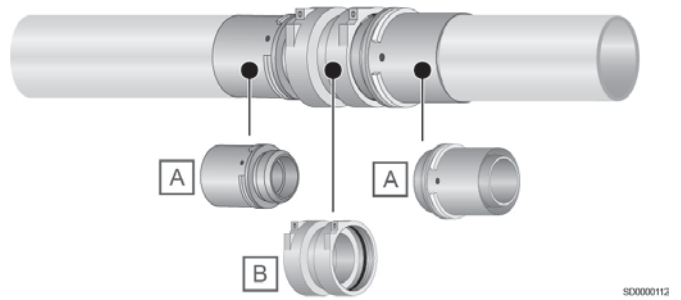

Item	Description
A	RS Press adapter
B	RS coupling

Reductions

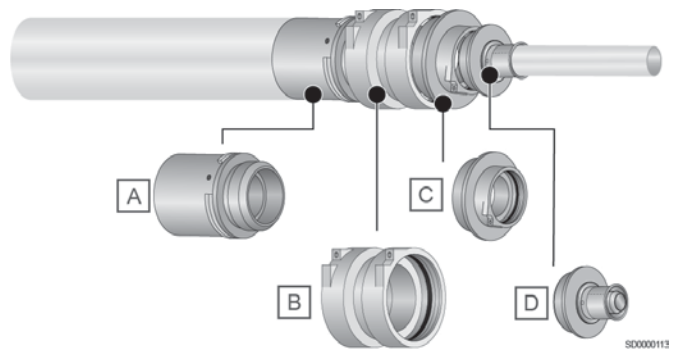

Item	Description
A	RS Press adapter RS3
B	RS coupling
C	RS adapter RS3/RS2
D	RS Press adapter 16 — 75 mm

Processing steps for Uponor RS fitting

Attach press adapter



First the press adapter is inserted into a composite pipe that has been cut off square and deburred.

Pressing



A permanent connection is established using the press chain and the corresponding base press jaw.

Connect with base body



Innovative plug-in technology connects the press adapter and base body to one other.

Locking



Finally, slide the locking element into the opening of the base body and let it engage.

Uponor RTM fittings







Uponor RTM offers a comprehensive range of fittings for selected Uponor pipes, which do not require any assembly tools to create the pipe joint. RTM fittings are quick to install and offer a high level of safety and longevity, both in drinking water distribution and in heating/cooling applications.

RTM fitting benefits

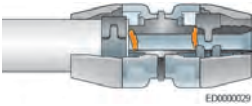
- Integrated pressing function
- Dimension-specific colour coding
- No special tools necessary
- Optical and acoustic connection test
- Fast and simple to process

Uponor RTM fittings, dimension overview

Dimensional range	Description/properties	Material	Colour code/ dimension
 16 — 25 mm	<ul style="list-style-type: none"> • One-piece fitting with integrated pressing function (ring tension memory). • The pressing process is initiated by the inserted pipe end; no additional tools are required for pressing. • Simple pressing control with the 360° viewing window and clearly audible click. • Dimension-specific colour coding of the safety locking device. • Subsequent alignment possible. 	<ul style="list-style-type: none"> • High-performance PPSU plastic or brass • Press ring made of high-strength, specially coated carbon steel 	 16
			 20
			 25

Pressing carried out

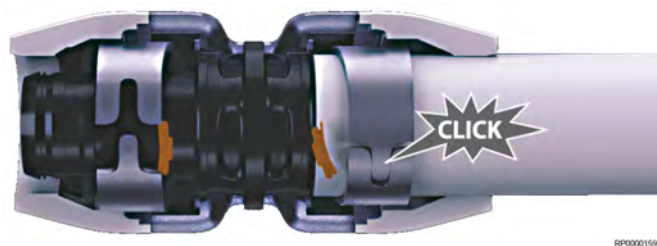

The released safety lock can be seen through the 360° viewing window. It does three things: It holds the press ring in tension until it is pressed, contains the colour coding for the dimension and indicates that the pressing process has been completed.

Processing steps for Uponor RTM fittings

Cut the pipe



The pipe is first cut off square using the Uponor pipe cutter.

Calibrate



Before the fitting is assembled, the pipe end must be calibrated.

Pressing



The pressing process is controlled by inserting the pipe until the click sound is heard.

Check

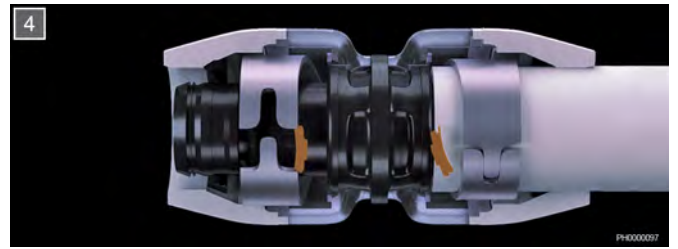

Successful pressing can be seen through the transparent inspection window. If the colour-coded spacer has been pushed through the pipe end and out of the prestressed press ring, the press ring is closed

Insert the pipe until it clicks



When the composite pipe is inserted into the RTM press fitting, the safety lock is released from the press ring. A clear click can be heard to signal the successful connection.

Uponor Uni



Uponor Uni-X includes a selection of 3/4" euro-cone fittings and adapters for drinking water distribution and heating/cooling applications.

In addition to the tin-plated Uni-C manifolds with 1/2" joints, Uponor Uni-C also includes a selection of 3/4" screw connections and adapters for drinking water distribution and heating/cooling applications.

Uponor Uni

- Simple transitions to other systems
- High application flexibility
- Can be processed with conventional tools

Uponor Uni screw connection MLC, dimension overview

Dimensional range	Description/properties	Material
 <p>14 — 20 mm (Uni-C) 14 — 25 mm (Uni-X)</p>	<ul style="list-style-type: none"> • Two-part screw connection made of brass, with tin-plated union nut and pressure sleeve. • For the direct connection of Uponor composite pipes to 1/2" Uponor fittings, manifolds and sanitary connections. • The 3/4" variant allows connection to 3/4" euro-cone moulded parts. 	<ul style="list-style-type: none"> • Union nut, brass, tin-plated • Pressure sleeve, brass, plated

4 Drinking water distribution

4.1 System description

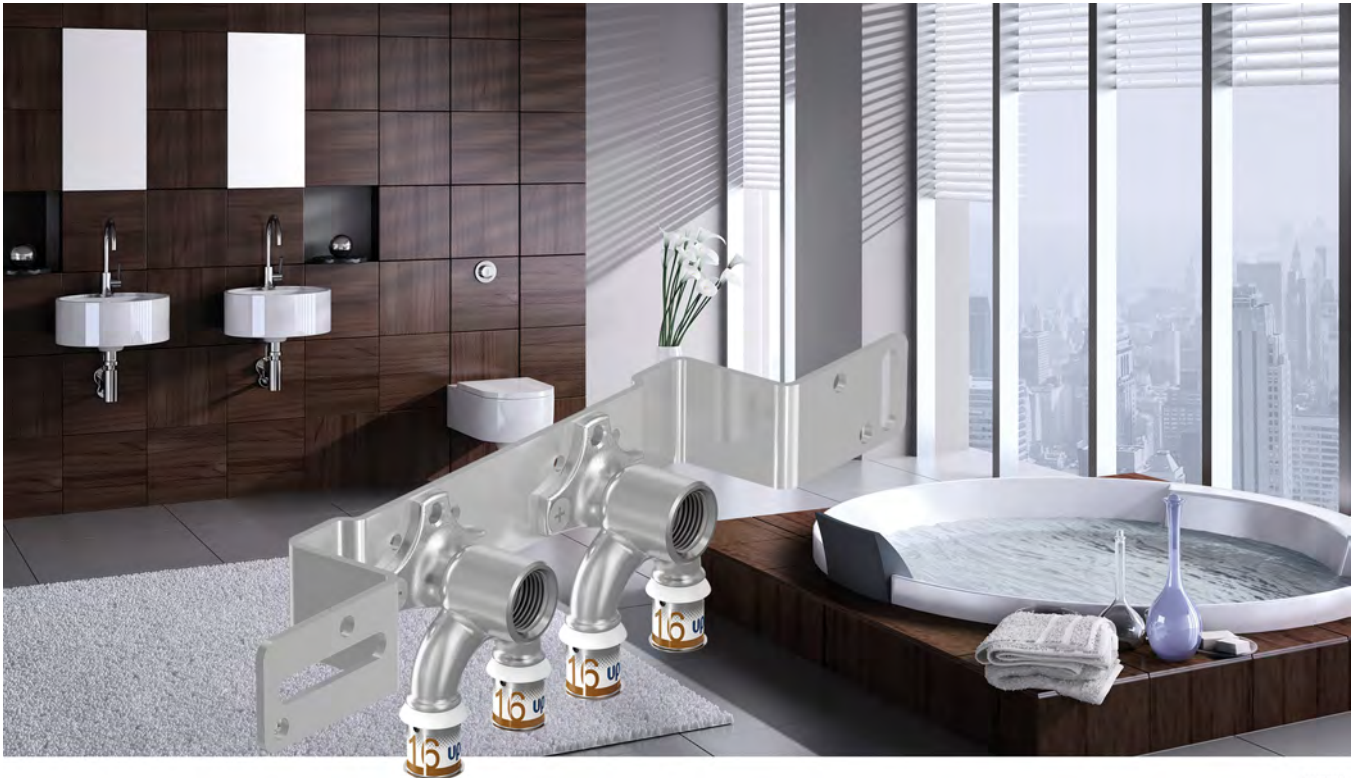

PH000099

Uponor tap water components enable economical and simple installation in all areas, as well as hygienic system operation. The multifunctional concept means that fewer components are required for installation. For example, Uponor wall brackets can be used equally well on mounting plates, mounting rails or directly on the wall. Uponor tap water components allow all common connection variants to be realised, from T-joint installation to hygienic loop or series installation.

Drinking water distribution with the Uponor composite pipe system

- Wide range of mounting options with only a few components
- Strong, non-twisting connection of wall brackets and mounting rail
- Wall bracket can be used both on the wall and on the rail
- Flow-optimised U-shaped wall brackets for lower pressure losses in loop installations
- Matched system with mounting rails, wall brackets, sound insulation and waste water connection
- Proven Uponor press and RTM fitting connection technology

4.2 The tap water connection system from Uponor



PH000100

Functional and practical

Uponor tap water components in the composite pipe system are the result of further refinement of our innovative products. The perfectly coordinated product range enables you to carry out cost-effective, simple assembly in all areas.

More options with fewer components

The multifunctional concept means you need fewer components for your installation. For example, Uponor press wall brackets can be used equally on mounting plates, mounting rails and directly on the wall. The refined design is adapted to all practical requirements.

Assembly-friendly design

The new Uponor tap water connection system is designed for fast and easy installation in practice. Practical details like the fastening screw with "fall arrest", make your work easier and ensure that assembly is carried out quickly and without unnecessary loss of time.

Time savings with prefabrication

The Uponor tap water connection system also includes prefabricated sets for common installation requirements. This saves you valuable time during installation on site.

Sophisticated fixing material

Pre-bent mounting rails as well as mounting plates and wall brackets for various installation situations facilitate work on the construction site.

Practical accessories

Accessories like the Uponor sound kit and waste water kit complete our delivery programme to ensure that nothing is missing on the construction site that is required for professional installation.

4.3 Main tap water components

Uponor wall brackets – quick and professional installation

Note

For an even greater variety of connection types, Uponor S-Press PLUS U wall brackets are now also available with a single-sided reduced connection (16-Rp $\frac{1}{2}$ -20 and 20-Rp $\frac{1}{2}$ -16 as well as 25-Rp $\frac{1}{2}$ -20 and 20-Rp $\frac{1}{2}$ -25).



Uponor S-Press PLUS U wall brackets with reduced connection on one side



Uponor S-Press PLUS wall brackets with mounting plate and sound protection set

Uponor wall brackets together with the matching mounting plates, rails and angles enable quick and versatile connections. The guide pin, which is simply inserted into the back of the mounting rail, allows the wall bracket to be easily locked in the desired position (-45°/90°/+45°). The fixing screws ensure a stable and torsion-proof connection between wall plate and rail.

Uponor wall brackets

- Made of tin-plated brass
- Can be used either for surface mounting or on the Uponor mounting brackets or mounting plates
- Different designs and dimensions for U-shaped, single or double connection
- Available with pressed, RTM or threaded connections



Uponor stainless steel wall brackets and adapters (SST)



The Uponor wall brackets and U wall brackets as well as fittings with stainless steel thread/press transition in conjunction with the Uponor composite pipes are the ideal problem solvers in critical tap water situations, such as low overall hardness of the tap water, or tap water with a corrosive effect on copper and brass materials.

In addition to the Uponor S-Press fittings, Uponor offers another material variant for lead-free installations made of the high-performance plastic PPSU.

- Stainless steel fittings for pure, hygienic and lead-free installation with existing stainless steel pipe systems – especially for critical tap water situations
- Enables lead-free installation
- Proven Uponor S-Press connection
- Transition to stainless steel pipe system uses a threaded connection or SST press technology

Feed-throughs for loop and series installation in drywall construction



Uponor corner feed-throughs LWC with female thread according to DIN EN 10226-1 provide technically perfect and torsion-proof guidance through walls made from drywall, both during renovation and in new construction. Optionally as wall bracket or as U wall bracket for loop or series installation. Upon request, Uponor feed-throughs are also available in special lengths for installation depths from 35 to 65 mm in mm increments for specific projects.

Uponor feed-throughs are available with either Uponor S-Press PLUS, RTM or Q&E connection.

- In wall and wall feed-throughs in various designs
- Connections for common cisterns and fittings

Uponor drywall feed-throughs

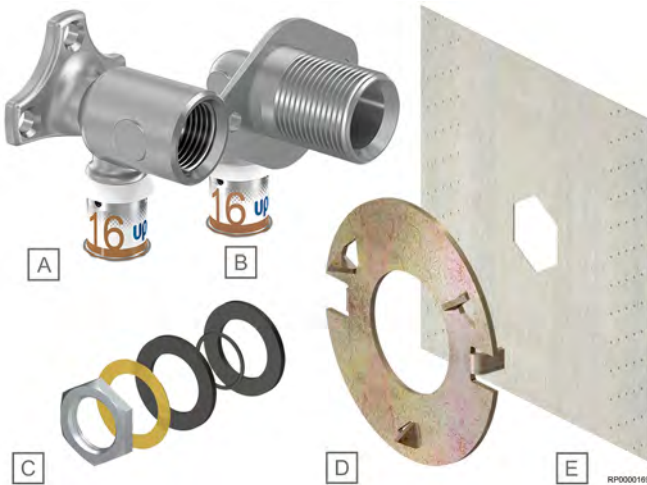

Item	Description
A	Uponor S-Press PLUS U corner wall seal LWC for optimum installation for series or loop installations in walls made from drywall
B	Uponor S-Press PLUS corner wall seal LWC for individual connection
C	Uponor mounting kit LWC
D	Uponor anti-twist device LWC
E	Uponor sealing flange LWC

- Variable installation depths of 25 or 35 mm for use in gypsum or wooden wall construction
- Optionally also available with sound insulation
- Available as corner wall seal and corner U wall seal
- Minimum installation depth, can also be used with low partition wall depths of only 40 mm
- Torsion resistance guaranteed during installation

Mounting options

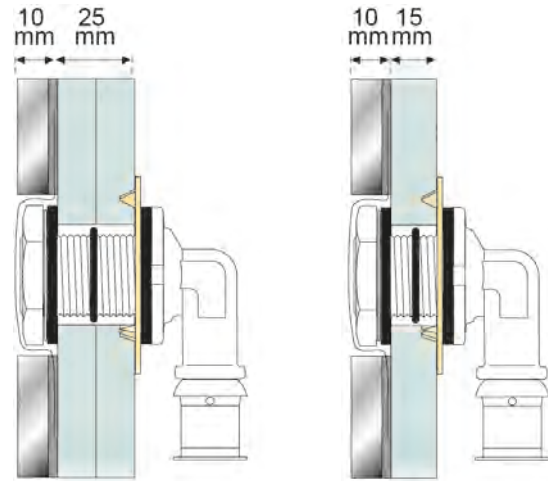

Torsion-proof installation in a plasterboard wall with Uponor anti-twist device LWC

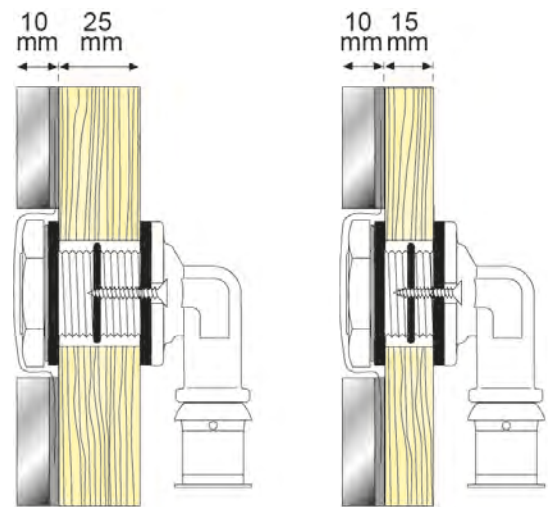

Torsion-proof installation in wood panelling with on site available wood screws

Loop fittings for hygienic drinking water distribution



Uponor U wall brackets and equipment connections with double connection enable hygienic loop and series installations

From a hygienic point of view, it makes sense to loop the water through at all tapping points – including in-wall fittings and cisterns– in order to avoid unnecessary stagnation in the system. For this purpose Uponor has also developed a special loop-through fitting for in-wall fittings in addition to the U wall brackets, which enables a continuous series or loop line installation.

Sound protection set for "whisper-quiet" operation



RP0000170

The Uponor sound protection set reduces the transmission of structure-borne noise from the installation to the wall structure and is compatible with Uponor mounting plates and brackets as well as mounting rails.

Uponor mounting accessories

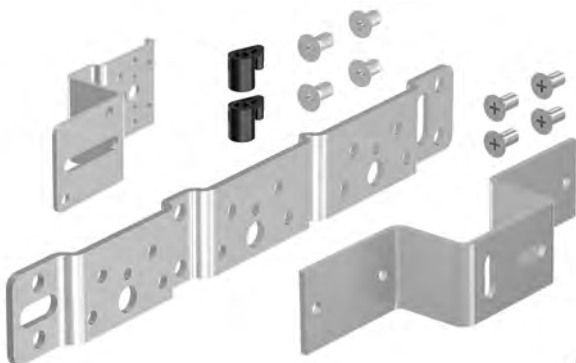

RP0000163

- Extensive assortment of mounting plates, rails and angles for the torsion-proof attachment of wall brackets
- Components for sound decoupling

Uponor prefabricated assemblies

Uponor assembly units



rp0000164

- Factory prefabricated sets for equipment and waste water connection
- With DIN 4109 compliant sound insulation
- Saves assembly time on the construction site

Uponor ISI boxes

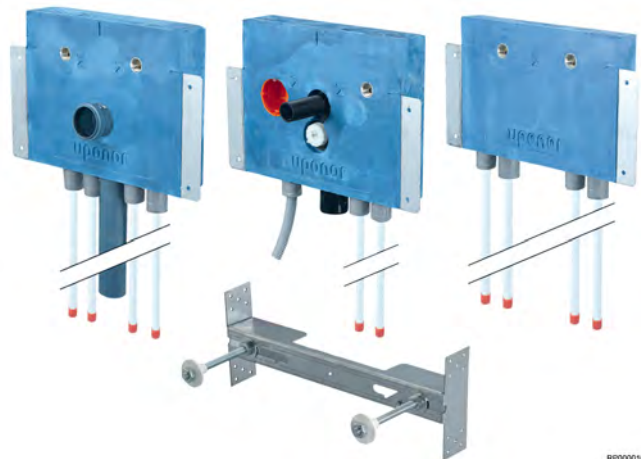

RP0000165

- Prefabricated assembly units for different equipment connections in drywall construction
- Insulating body made of closed-cell insulating foam
- Sound insulation tested according to DIN 4109 and VDI 4100 Class 2 and 3

Ready-to-connect Uponor Smart ISI equipment



RP000171

The Uponor Smart ISI boxes are designed for installation in partition wall systems and consist of a thermally insulating, condensation-proof insulating body with pre-assembled, ready-to-connect tap water components from the proven Uponor composite pipe system.



SC0000114

Item	Description
A	High-quality closed-cell PU foam with optimum sound insulation to DIN 4109 and VDI 4100:2012-10 as well as good thermal insulation properties ($\lambda = 0.024 \text{ W/mK}$)
B	Box centre marking for quick alignment
C	Markings for the centre of the wall for easy height adjustment
D	Uponor Smart S-Press PLUS U wall brackets at typical spacing, completely pre-assembled and tested
E	Sheet metal for fastening to drywall profiles using crimp technology
F	Preinsulated pipes for easy, quick additional insulation
G	Uponor Uni Pipe PLUS 16 mm composite pipes ready for connection with pipe connector plugs to prevent contamination
H	Uponor Smart ISI washbasin attachment WT (optional)



PH0000101

The integrated Uponor wall brackets and U wall brackets can be used in all T-joint, series or loop installations. The modules are already equipped with Uponor 16 mm composite pipes ready for connection. Pipe connector plugs protect against dirt on the construction site.

Uponor Smart ISI equipment connection boxes

- Prefabricated installation units for drinking water distribution
- Time-saving, secure and quick to install
- Energy-efficient thanks to continuous thermal insulation up to the tapping point
- Optimum sound insulation according to DIN 4109 and VDI 4100:2012-10

5 Uponor Smatrix Aqua PLUS

5.1 System description



Variations in use of sanitary installations in buildings can lead to water stagnating in seldom-used pipe sections. This can lead to contamination of the tap water with e.g. bacteria, resulting in hygiene problems. The Uponor Smatrix Aqua PLUS flushing system is the ideal solution for hygiene problems, especially in nursing homes, clinics, sport facilities and hotels.

The smart monitoring technology allows the water flow of several buildings to be monitored and regulated – easily on a computer or on the go with a mobile device. Uponor Smatrix Aqua PLUS can also be retrofitted in older buildings if a loop installation is present. Only minimal time and cost are needed to meet all the requirements of the Germany Drinking Water Ordinance – from planning to operation.

Benefits

- Safe compliance with hygiene requirements and legal standards
- Enables fast and easy installation and commissioning and ensures proper operation as early as the shell construction phase

5.2 Uponor Smatrix Aqua PLUS flushing unit

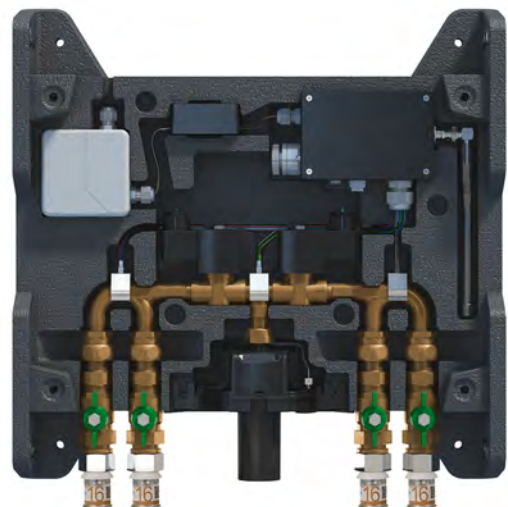

Uponor Smatrix Aqua PLUS is a ready-to-install flushing unit for the automated hygienic flushing of cold and hot water pipes in loop or series installations in accordance with VDI/DVGW requirements. Prefabricated at the factory including the insulating shell and Uponor S-Press connection for Uponor composite pipes and DN 40 waste water connection. Standard flushing criteria and parameters such as flushing times and duration are already pre-set in the integrated control unit. These values can be changed from any computer using the optional Uponor Smatrix Aqua PLUS USB radio receiver.

Flushing unit components

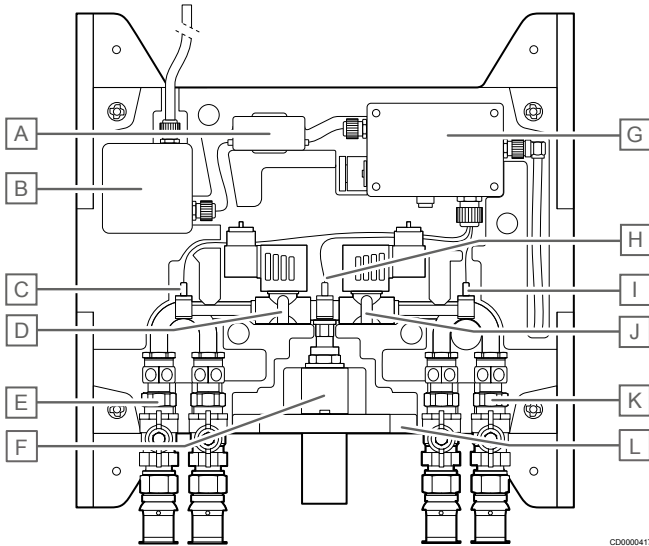

CD0000417

Item	Description
A	Power converter
B	230 V junction box
C	Hot water temperature sensor
D	Hot water solenoid valve
E	Hot water connection (PWH) with shut-off ball valve
F	DN 40 waste water connection
G	Control box with wireless module
H	Inactive
I	Cold water temperature sensor
J	Cold water solenoid valve
K	Cold tap water connection (PWC) with shut-off ball valve
L	Float switch (backflow protection)

Dimensions (mm)

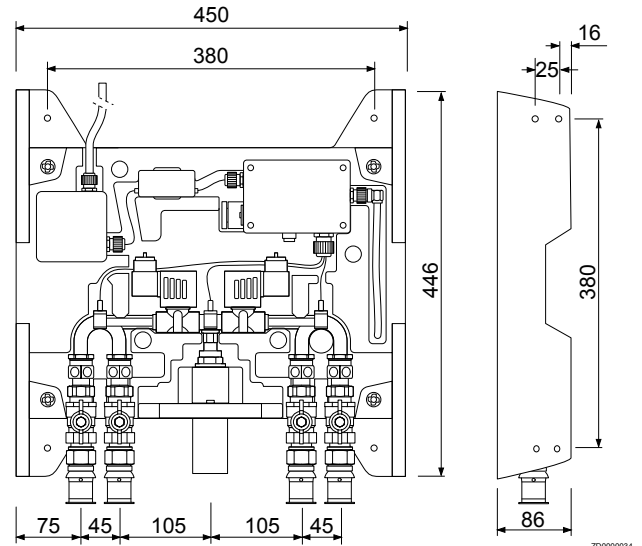

ZD0000034

Technical data

Description	Value
Max. operating pressure	10 bar
Max. operating temperature	70 °C
Min. ambient temperature	5 °C
Max. ambient temperature	40 °C
Min. flow pressure	1000 mbar
Max. flow volume	0.2 l/s
VHF radio frequency	169 MHz
Radio range	1000 m (clear view)
Power supply	230 V AC/50 — 60 Hz
Tap water connection	Uponor S-Press
Waste water connection	DN 40

5.3 Function description

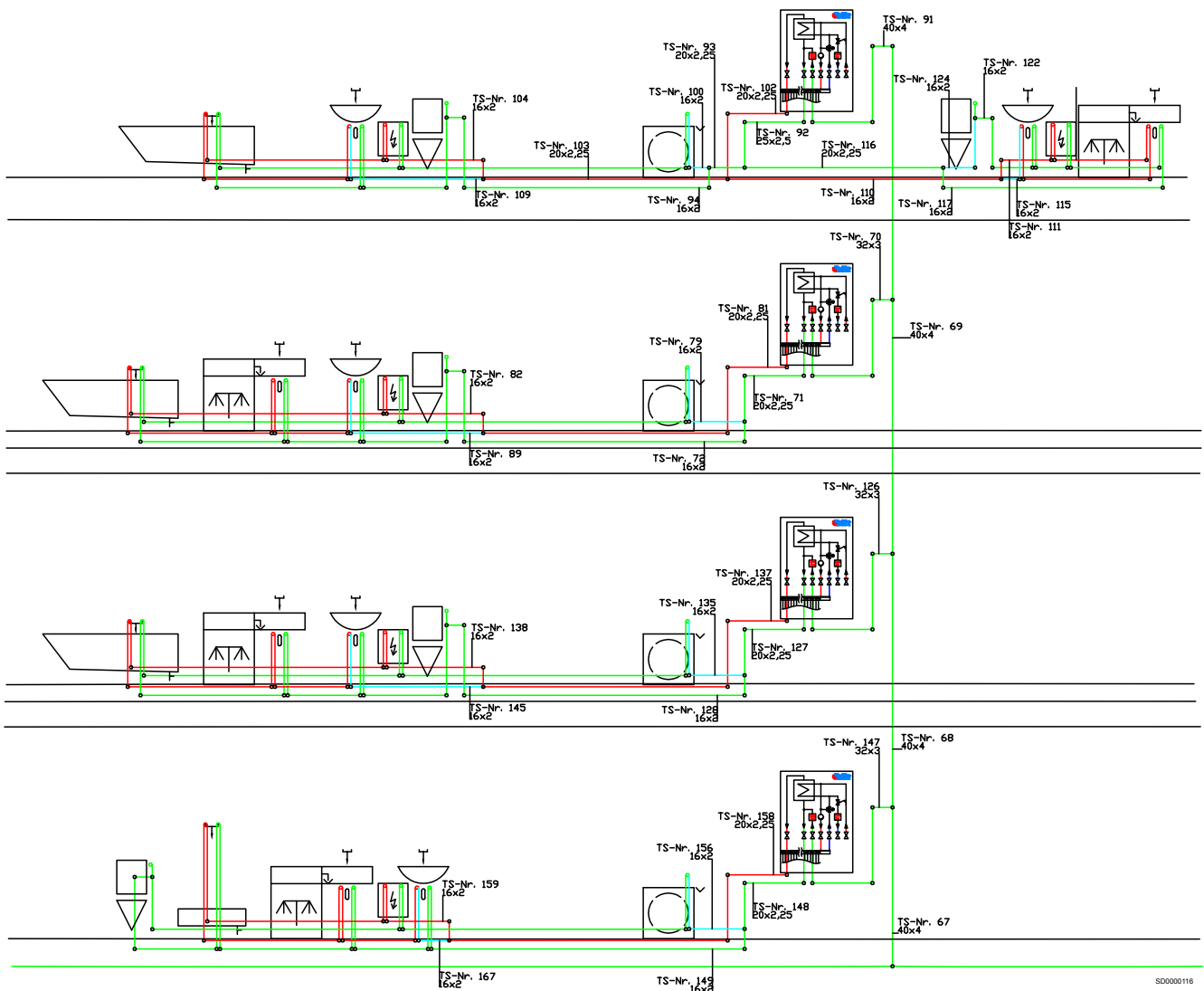

The automatic Uponor Smatrix Aqua PLUS flushing unit is a key component of Uponor hygiene logic. Using sensors, it permanently monitors and regulates the proper operation of drinking water distribution systems and ensures hygienic water exchange. Based on the loop installation in a drinking water installation, the Uponor Smatrix Aqua PLUS flushing unit can be integrated into any section of the loop.

All materials that come into contact with drinking water meet the hygiene requirements of the KTW Guideline and DVGW Worksheet W 270 and comply with the UBA Positive List (4MS). The tested backflow protection also ensures a high level of safety, as confirmed by the DVGW test according to DVGW Worksheet W 540. Connections from below with the Uponor S-Press fitting profile facilitate integration into the loop line and save time and material.

Water stagnation is noticeable from the constant temperatures at the measuring points. To meet VDI/DVGW 6023 requirements, the threshold values have already been preset in the factory. If the pre-set maximum stagnation times are exceeded, the Uponor Smatrix Aqua PLUS flushing unit flushes the hot and cold water loops alternately. During normal operation, the water throughout the pipe network is exchanged when the target temperatures are reached.

6 Hot water generation

6.1 Uponor decentralised heat interface units

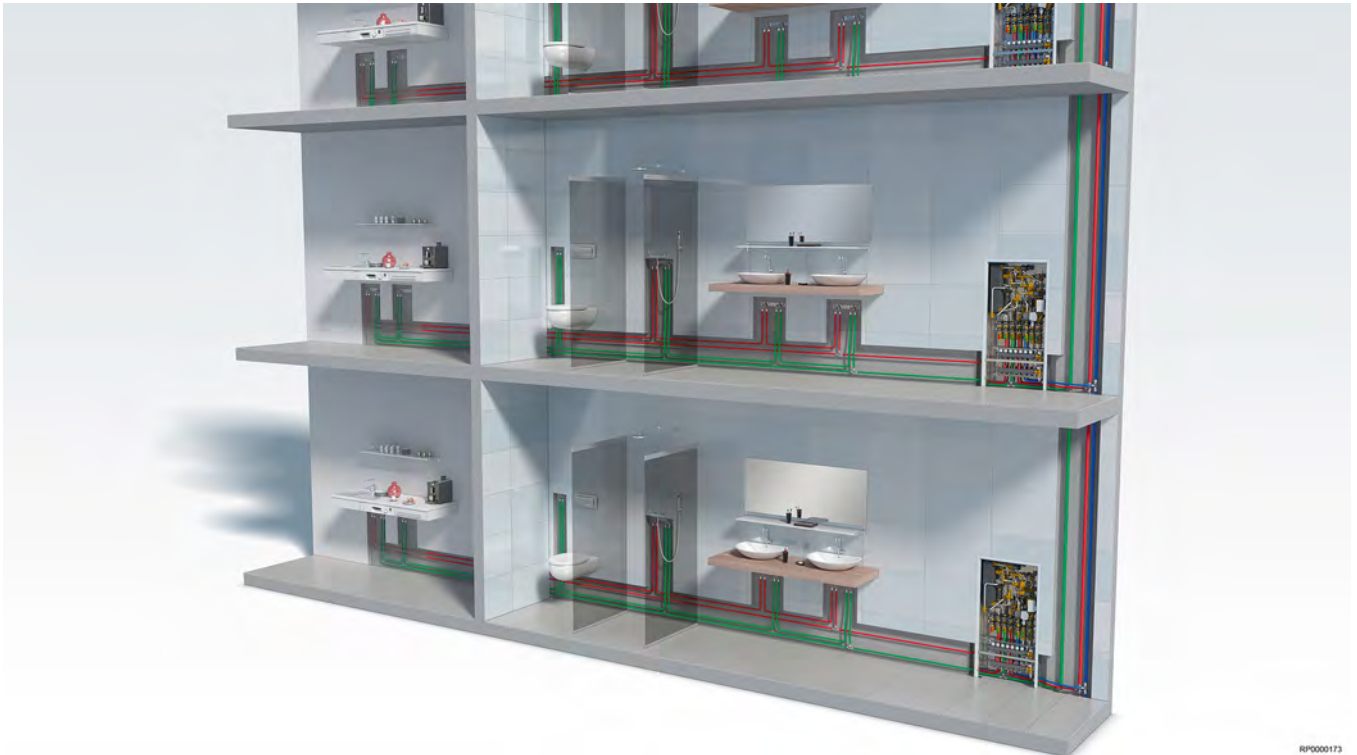

RP0000173

One of the key factors that influence perfect drinking water quality is the avoidance of long holding times and unfavourable temperature ranges. Decentralised heat interface units and loop installations offer maximum security, so that the risk of microbial contamination can be minimised.

The requirements for the safety and purity of drinking water are clearly defined. The planning, construction and operational implementation is often associated with problems, as is frequently revealed by the large number of findings over the action value for Legionella. Added to this is the increased demand among consumers for an unlimited supply of hot water from the drinking water system at any time, preferably without any long delays.

Two criteria are key for optimum drinking water hygiene, according to the generally acknowledged rules of the trade: Regular water exchange within the entire piping system, as well as the maintenance of the required temperatures in the cold water, hot water and circulation pipes. In order to meet these requirements, from the transfer point in the building to the point of discharge, planners, installers and operators are jointly required to ensure that planning, installation and commissioning complies with regulations and legal requirements. Although this may sound complex and highly theoretical at first, life is made easier for all those involved in the construction industry if the risk of contamination is consistently ruled out in the planning phase. Anyone who decides on a domestic hot water supply in accordance with the flow principle with decentralised heat interface units eliminates risks such as legionella growth in cooler strata of central drinking water tanks or extensive circulation pipes.

In accordance with DIN 1988-200, in decentralised fresh hot water technology, the heat for hot water production is no longer stored in the drinking water itself but in a hygienically harmless form in heating buffer storage tanks. In addition, hot water distribution and circulation pipes in the building, which may cause microbial contamination due to insufficient insulation or poor hydraulic balancing, are no longer

needed. A loop-through ring installation is recommended for the hygienic distribution of hot and cold drinking water on individual floors. This not only allows small line cross-sections and water volumes, but also enables flow through all parts of the pipe, regardless of which tapping points are used frequently, infrequently or not at all. This prevents stagnation in the single-storey distribution system during normal consumption.

In apartment buildings, a separate heat interface unit handles hygienic hot water preparation for each usage unit. An efficient heat exchanger not only ensures a high level of hot water convenience, but also low return temperatures, which in turn contribute to the energy-efficient operation of the heating system. It is also important for the operator that it should be easy to record consumption in every usage unit by means of the directly integrated water and heat meters.

The heat interface units are connected directly to the heating supply line in the 2-pipe system so that there is no need for the central hot water and circulation pipes in the supply shafts. This reduces the size of the supply shafts by approx. 40 %. As a result, radiated loss is avoided in the lines and in the no longer required drinking water storage tank. This not only increases energy efficiency, but also - much more importantly for hygiene - also prevents stagnation in the cold water line. Here, in contrast to the central hot water preparation system, a significantly higher water exchange takes place, as the cold water pipe covers the total requirement (hot and cold) of the connected usage units.

Buffering heat instead of storing it in the drinking water

Note

For more detailed information, product range and documentation please visit the Uponor website: www.uponor.com.

In addition, decentralised fresh water technology can effectively counteract the risk of contamination in drinking water. The circulation or storage of heated drinking water is completely avoided in decentralised fresh water stations, if possible. Only as much drinking water is heated to tap temperature, as the user needs right now. The required energy is not stored in the form of drinking water, but rather in buffer tanks that use heating water as a medium. Thus, the concept also meets the requirements of DIN 1988-200, which stipulates: "If energy is to be stored, it should not be stored in the drinking water, but instead the technique of storing energy in the heating system, e.g. through buffer storage, is to be preferred."

The benefits of decentralised generation of hot drinking water

Buildings are responsible for at least 40 % of global energy consumption and over a third of greenhouse gas emissions*. That's why new ways of enhancing energy efficiency in buildings are vital in combating human induced climate change. Uponor decentralised Combi Port & Aqua Port heat interface units make a key contribution by supplying on-demand, energy efficient hydronic heating and cooling as well as hygienic hot water.

For hygiene reasons, the hot water temperature in the tank and distribution lines of a centralised system must be kept at 55-60 °C, with even higher temperatures required to heat up the system. Since the decentralised domestic hot water generation and water volumes in the pipe system remain below 3 litres, the temperatures can be kept lower. The supply temperature to the heat exchanger needs to be only 5K higher than the desired domestic hot water temperature. The lower operational temperature and only two heat-emitting pipes ensure significant energy savings.

Hydraulic balancing is also easier and sustainable, while the constantly low return temperatures enhance the efficiency of both traditional and renewable energies.

Uponor decentralised heat interface units

- New generation of energy-efficient domestic hot water generation and heating/cooling distribution
- Hygienic hot water generation on demand to avoid legionella growth
- Individually developed & prefabricated heat interface units
- 58 % energy savings in distribution pipes through decentralised heat supply system
- Up to 80 % energy savings in renovation projects (incl. insulation measures)
- Lower investment costs than conventional systems and significantly lower operating costs

Further benefits

- No need to store drinking water in service water tanks
- No need for mandatory testing according to the German Federal Drinking Water Ordinance (TrinkwV)
- Drinking water heating using the through-flow principle
- Heating distribution circuit integrated in the station ready for installation
- Pump modules with injection circuit for radiant heating systems
- Residential unit heating system available all year round with individual regulation

6.2 Comparing a 2- and 4-pipe system

Comparison between a 2-pipe system with heat interface units and a conventional 4-pipe system with central hot water preparation.

Decentralised heating of drinking water

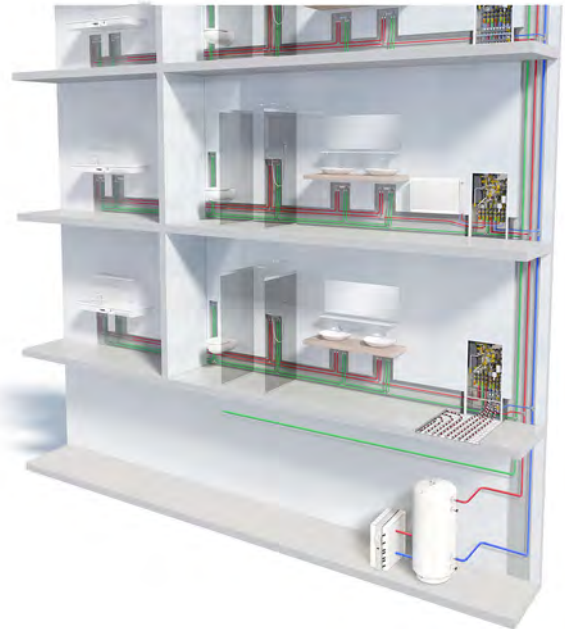

RP0000174

- Decentralised flow heater, giving legal security to residential development operating companies.
- Saving on hot drinking water and circulation pipes from the central heating system to the residential units.
- Low system temperatures in the building piping network, as hot drinking water pipes and circulation pipes are not required.

Centralised drinking water storage

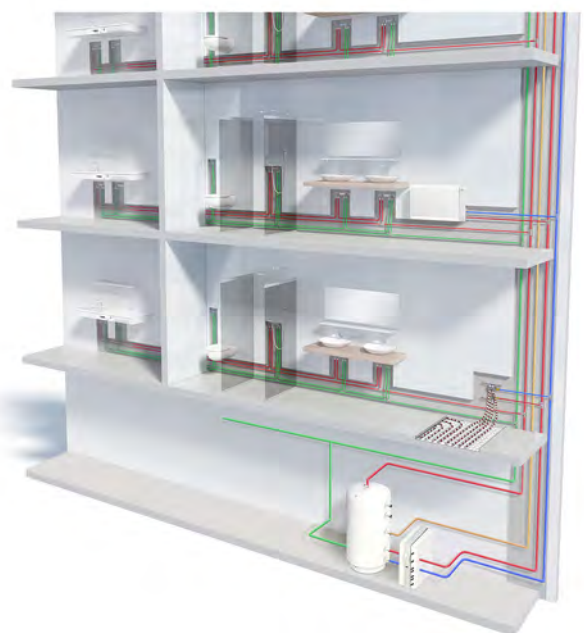

RP0000175

- Large system* subject to mandatory testing by residential development operating companies.
- Increased effort for pipe network, as hot drinking water pipes and circulation pipes are required.
- High temperatures in the building piping network in order to maintain drinking water hygiene.

* According to German Federal Drinking Water Ordinance (TrinkwV) Article 14

In conclusion

There is a 58 % energy saving with a 2-pipe system compared to a central domestic hot water system.

Final report on the project: "Methods for reducing conventionally generated heat distribution losses in solar-supported multi-family homes", acronym: "MFH-re-Net", funding code: 03ET1194A. The report is available to download from www.uponor.com.

6.3 General technical information

Technical data

Description	Value
Max. operating temperature	85 °C
Max. primary differential pressure	2.5 bar
Operating pressure	PN 10
Including heating circuit pump and manifold	PN 6 to PN 10
Minimum cold water pressure	approx. 2 bar
Connections, flat-sealing	3/4" IG or 1"

Technical data for consumer and drinking water stations (all stations must be earthed).

Heating system

The heating system must be planned and implemented in accordance with accepted engineering practices, as well as the DIN standards and VDI guidelines described below. If necessary, please observe the applicable and comparable country-specific regulations and standards.

The list is not necessarily exhaustive.

- DIN EN 6946 Calculation of the U-value
- DIN EN 12831 Calculation of heat load
- DIN EN 128282 Heating systems in buildings - Planning of water-based heating systems
- DIN 18380 VOB / C
- DIN 4109 Sound insulation in buildings
- TRGI Technical Rules for Gas Installation
- VDI 2035 Conditioning of heating water
- EneV Energy Saving Directive

We recommend that sludge and air separators should be fitted. The expansion vessel must be adapted and adjusted to the system.

Drinking water delivery

The drinking water installation must be planned and implemented in accordance with the German Infection Protection Ordinance, in particular Article 37 of the German Infection Protection Act, DIN 1988, DIN 50930 Part 6, DIN 2000, DIN 2001 and DIN 18381 as well as VDI 6003 and VDI/DVGW 6023 and the DVGW directives quoted below, as well as generally accepted engineering practices. (The list is not necessarily complete.)

These are:

- W 551 Drinking water heating and drinking water piping systems, technical measures to reduce Legionella growth
- W 553 Dimensioning of circulation-systems in central drinking water heating systems
- W 291 Cleaning and disinfection of water distribution systems
- Regulations of local water supply companies
- The applicable and comparable country-specific regulations and standards.

This results in a number of points that should be pointed out specifically in what is not necessarily an exhaustive list. For buildings with six or more floors we recommend installing a pressure reducer in the cold water intake.

Heat exchanger (statutory and legal bases)

The water must be analysed to clarify whether copper-welded heat exchangers (standard version) or possibly diffusion-welded heat exchangers are used. These are necessary if, for example, conductivity is greater than 500 µS/cm or if galvanised hot water pipes are found in the property during renovations.

Avoiding water hammers

According to DIN 1988-200, section 3.4.3, the sum of water hammer and static pressure must not exceed the permissible operating pressure.

- The permissible operating pressure for heat interface units is 10 bar.

When heat interface units are operated in drinking water installations, care must be taken to avoid high water hammer (for example due to fittings, booster systems, etc.). In the case of fittings with very short opening and closing times, there are always strong short-term pressures that exceed the specifications of DIN 1988-200, section 3.4.3, inadmissibly.

The following specifications must therefore be observed when operating the drinking water installation:

- The positive pressure surge (when closing the fitting) must not exceed 2 bar.
- Negative pressure surges (when opening the valve) must not be more than 50 % lower than the flow pressure created after opening.

Damage to components such as heat exchangers (solder cracks, deformation of exchanger plates, leaks, etc.) may result in a breach of this DIN specification. DVGW worksheet W 303 recommends the most effective and reliable measure to optimise pressure at the point of origin. The operation and maintenance of the systems must be in accordance with DIN EN 806-5.

6.4 Main operating principles

Proportional volume control valve

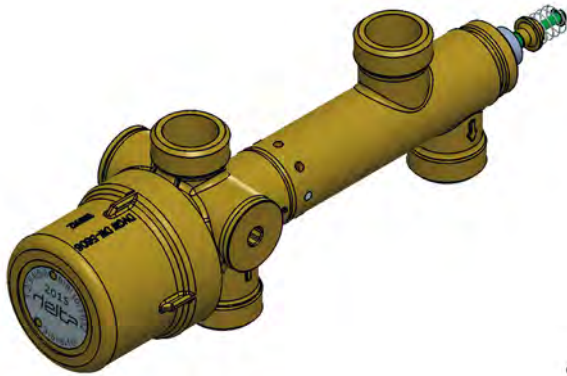

CD0000418

The proportional volume control valve is a central element of domestic hot water supply in our heat interface units. It is responsible for the rapid switching of the heating system to domestic hot water supply. As standard, the proportional volume control valve ensures the proportionality of the through-flow rates of hot water and drinking water. Most units have a priority circuit for domestic hot water instead of home heating. The heating water cannot enter the drinking water system via the proportional volume control valve or vice versa.

The system interior has a coated drinking water side and a patented triple seal on the moving parts in the sanitary and heating area.

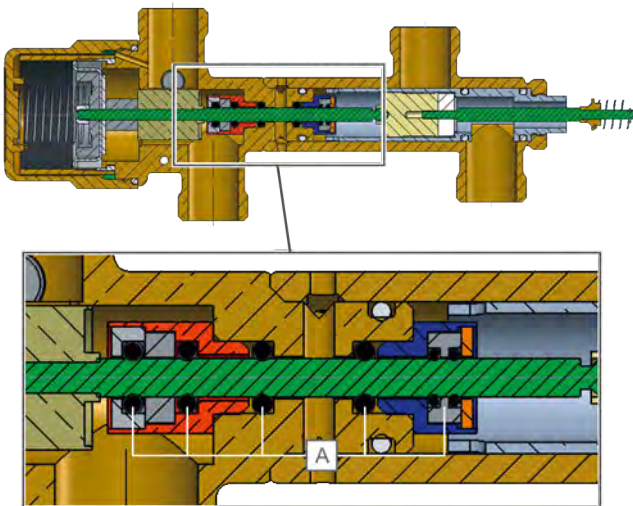

ED0000033

Item	Description
A	Triple seal

Operating mode

a) Hydronic heating

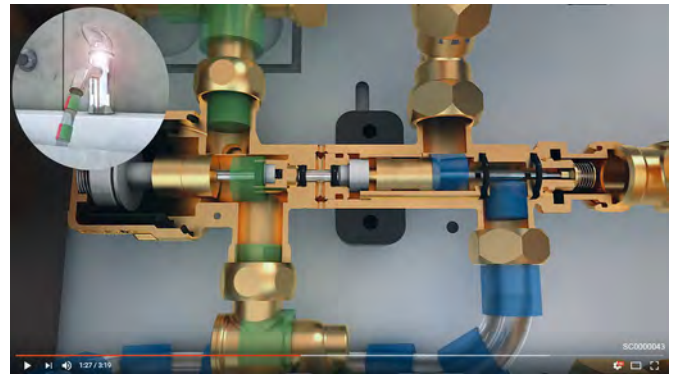

The starting signal is the opening of the hot water tap. The cold water pressure pushes the PM regulator to the left on the roller diaphragm and thus initiates hot water dispensing. The route to the heat exchanger for the heating system is opened in response to hot water requirements. Home heating is deactivated while the hot water tap is in use. The proportionality on the heating side is assured by means of a cover.



CD0000419

b) Heating mode

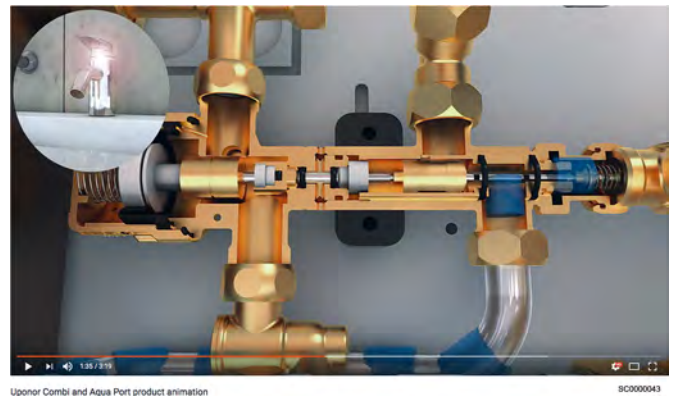

Uponor Combi and Aqua Port product animation

SC0000043

The hot water tap is closed, the spring pushes the proportional volume control valve to the right again back to its starting position. The energy supply to the heat exchanger is stopped and released for home heating.



<https://www.youtube.com/>



Uponor Combi and Aqua Port product animation – available on YouTube

6.5 Variants of Uponor heat interface units

Note

For more detailed information, product range and documentation please visit the Uponor website: www.uponor.com.

Decentralised heat interface units



RP0000176

Uponor Combi Port PRO UFH including drinking water generation in combination with heating/cooling connection

Uponor decentralized heat interface units heat the tap water in residential and office buildings directly on-site on the same floor using a flow-through principle. Due to the direct connection to the heating supply, neither hot water storage tanks nor hot water distribution with circulation lines in the supply shafts are required. Uponor decentralized heat interface units are also available as so-called Combi Ports, in which the drinking water heating is combined with surface heating/cooling.

Satellite installations for remote tapping points

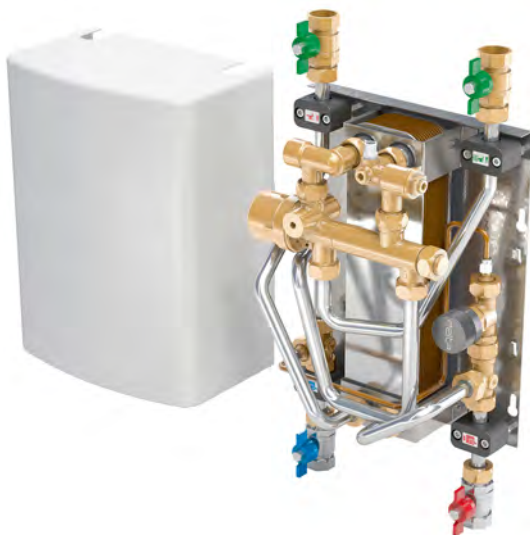

RP0000177

Uponor tap water heating station Aqua Port Compact

Compact "satellite installations" such as the Uponor Aqua Port Compact water heating installation can be used on floors with extensive drinking water distribution at remote tapping points (such as the kitchen sink or guest bathroom). This means that short output times can also be achieved without a circulation line. In addition, the

measure usually reduces the pipe volume downstream of the fresh water installation to less than 3 litres, thus eliminating the sampling requirement.

Centralized heat interface units



RP0000178

Uponor Aqua Port centralized heat interface unit

Uponor centralized heat interface units heat tap water centrally in the central heating system and direct it via a hot water and circulation line (PWH and PWH-C) to the tapping points. A heating buffer storage tank provides the energy required to heat the hot water. In addition, very effective regenerative energies can be integrated into this buffer storage. Tap water is not stored – the heating of the water takes place only when necessary. The modular design enables flexible performance adaptation to different property sizes, from terraced houses to large-scale facilities in barracks, industrial systems, hotels, care facilities and hospitals.

7 Planning principles for water distribution

7.1 General information

Drinking water is our most important foodstuff

Drinking water intended for human consumption must be free from pathogens, fit for human consumption and pure. Its quality must be such that it does not adversely affect human health even after lifelong consumption. This is why the strictest demands are made on the quality of drinking water. No other foodstuff is checked as regularly or frequently.

Protection of drinking water

The protection of drinking water is laid down in the Federal Drinking Water ordinance. Homeowners, architects, planners and plumbing, heating and air conditioning installers bear the responsibility for many years to ensure that drinking water at every tap complies with the chemical and microbiological requirements (parameters) of the regulation.

Measures to reduce Legionella growth



Legionella pneumophila

In drinking water heating systems and their connected hot water distribution systems, conditions must be created that prevent a concentration of Legionella that is hazardous to health.

Legionella are rod-shaped bacteria which occur naturally in small amounts in fresh water, e.g. in lakes, rivers and occasionally also in tap water. The group of Legionella includes some 40 known forms. Some Legionella species can cause infections by the inhalation of contaminated aerosols (finest water droplets) into the lungs, for example while showering or from humidifiers in ventilation systems. In persons with health limitations such as a weakened immune system or chronic bronchitis, this can lead to pneumonia (Legionella pneumonia or Legionnaires' disease) or Pontiac fever.

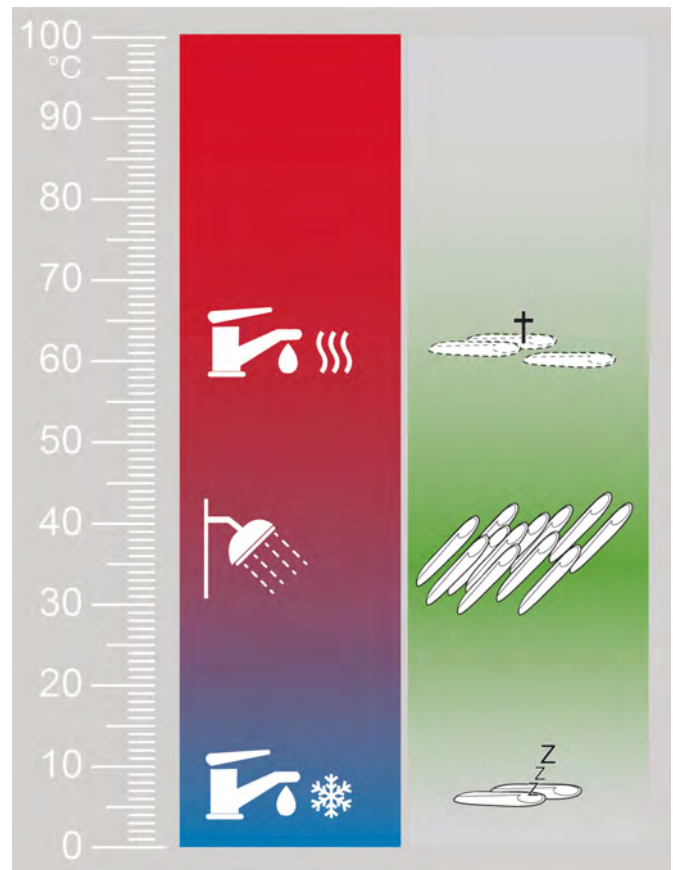

Influence of water temperature on Legionella proliferation

According to DVGW Worksheet W 551, the risk of infection is directly related to the temperature of the tap water extracted from the drinking water distribution system and the length of stay in the system. The temperature range in which Legionella growth occurs is between 30 °C and 45 °C. The worksheet describes the technical measures needed to reduce Legionella growth in drinking water distribution systems, based on the current state of knowledge. Measures for the remediation of contaminated drinking water systems are also listed.

When planning and dimensioning drinking water pipes, the following points are important from a hygienic (microbiological) point of view:

- The shortest possible pipelines and small but hydraulically sufficient pipe diameters in order to achieve the shortest possible residence time of the tap water in the system.
- Stagnation of tap water in parts of the system that have not had water flowing through should be avoided.
- The heating of cold tap water distribution systems by environmental influences must be avoided.
- Unused parts of the network must be emptied and disconnected.

Generally recognised engineering practices

The Drinking Water Ordinance as well as other laws and Ordinances often refer to the "generally recognised engineering practices". These include national standards and guidelines (DIN, DVGW, VDI) or international standards (EN, ISO) and technical data sheets from the relevant associations. These documents are used by the courts to assess whether an installation is designed, built and operated in accordance with generally accepted engineering practices. The generally accepted engineering practices for the construction and

operation of drinking water distribution systems are laid down in the European basic standards DIN EN 806-1 to 5, DIN EN 1717 and the national supplementary standards DIN 1988-100 to 600 "Technical Rules for Drinking Water Delivery - (DVGW) Technical Rules". In addition, DVGW Worksheets W 551 and 553 and VDI standard 6023 "Hygiene in drinking water distribution systems" must be observed.

European standards with national supplements

European basic standards	National supplementary standards
DIN EN 1717 Protection of drinking water	DIN 1988-100 Protection of drinking water
DIN EN 806 Part 1: General information	-
Part 2: Planning	DIN 1988-200 Planning
Part 3: Pipe sizing	DIN 1988-300 Pipe sizing
Part 4: Installation	-
Part 5: Operation and maintenance	DIN 1988-500 Pressure boosting stations with RPM-controlled pumps
-	DIN 1988-600 Drinking water installations in connection with fire fighting and fire protection
-	DIN 1988-7 Corrosion and scaling is defined in DIN 1988-200

European basic standards with national supplementary standards for the planning and construction of drinking water distribution systems

Holistic, property-specific planning is important

The planning stage already sets the course for hygienic and energy-efficient drinking water distribution and comfortable use. A modern drinking water distribution system must not only comply with current engineering practices to ensure tap water hygiene, it should also be energy-efficient. The demands on the comfort of drinking water distribution have also risen significantly. Modern bathroom fittings with high flow rates and strict requirements for hot water output times (e.g. DIN 1988-200 or if the work contract specifies it, VDI 6003) can be a challenge for the planner. In order to meet all requirements, integral planning involving all the trades concerned is necessary. Here a room data sheet coordinated with the owner can be helpful. This should include at least the following specifications:

- a detailed description of equipment and use (VDI 6000)
- the concept for drinking water distribution with pipe routing and tapping points
- specifications for intended use

7.2 Installation variants

Loop installation

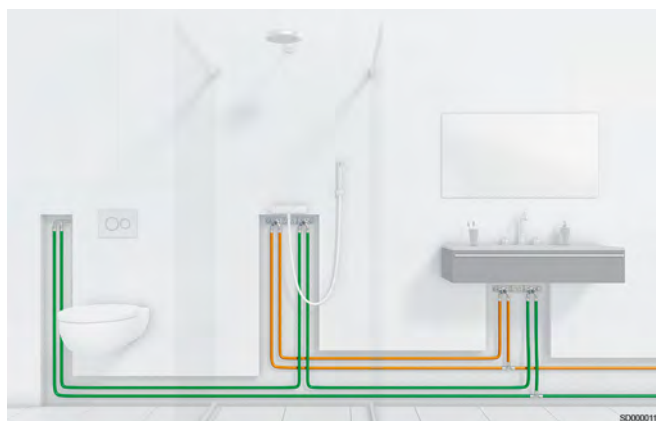

In a loop installation, the tapping points are connected in a similar way to a series installation. However, the line from the last consumer leads back to the starting point. This enables a hygienically perfect water exchange during operation, regardless of the tapping point from which water is taken. As the tapping points are supplied from two sides, assembly effort is reduced. The plumber can use a single dimension throughout for the connecting lines. In addition, the loop installation allows the automatic Uponor Smatrix Aqua PLUS hygiene flushing unit to be integrated into the loop line at any point. The best place is where connecting to the sewage pipe is easiest.

Series installation



In a series installation, the tapping points are connected to the Uponor S-Press U wall bracket and the installation pipes are immediately routed to the next tapping point. Thus a complete water exchange of the floor installation takes place when the last tap is used. Ideally, therefore, the most frequently used consumer, for example the toilet flush or the washstand, should be included at the end of the row. With this type of installation, a flushing unit must be permanently connected to the last consumer, which may not be compatible with the waste water system. Just as with a T-installation, a larger pipe dimension is usually used, which is then progressively reduced until the last outlet.

T-installation



In a T-installation, all consumers are individually connected to the supply lines via T-joints. The installation is usually started with a larger pipe dimension, which is then reduced progressively until the last tapping point. This minimises line distances. However, in T-installations there is a risk that water will stagnate and germinate in the connecting pipes to consumers used less frequently. A T-installation should therefore only be used at tapping points used daily and regularly.

7.3 Circulation systems

Hot water distribution systems, in which hot water is to be provided continuously directly at the tapping points, should have a permanently maintained hot water circulation. DIN 1988-300 must be used to size the pipe diameters in the circulation systems and the boundary conditions specified in DVGW Worksheet 551 must be observed in order to avoid the above-mentioned health hazards.

Requirements

The entire hot water distribution system should be operated in such a way that, on the one hand, the hot water leaves the water heater at a temperature of at least 60 °C and flows back into the heater with a temperature loss of at most 5 K. On the other hand, there must be sufficient hot water volume flows in all circulation lines. The DVGW Worksheets recommend operating the circulation system with a water temperature of at least 57 °C at the end of each return line.

Protection of cold water pipes from heating

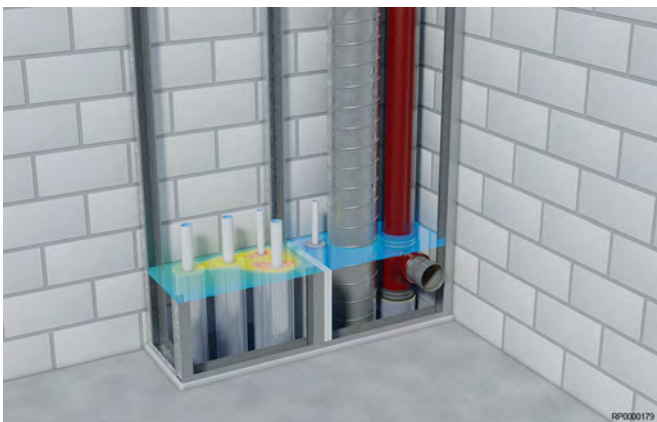

Thermally isolated cold water line (PWC) in an installation shaft to prevent inadmissible heating

Circulation systems can have negative effects on tap water hygiene, for example if circulation lines are laid together with cold water lines in shafts or pre-wall installations. The danger here is that the water in

the cold water pipe will heat to a point above the permissible value of 25 °C and become contaminated with germs.

To minimise the risk of germs in cold water pipes, the following measures are possible, for example:

- Lay warm lines (heating, PWH, PWH-C) and cold water lines (PWC) separately
- Sufficient insulation of hot and cold water lines (EnEV, DIN 1988)
- Eliminate circulation lines due to decentralised tap water generation (by installing heat interface units)

Calculations

The required volume flows are calculated according to DIN 1988-300 using the differentiated design method. For cold and hot water pipes in buildings with up to six apartments without circulation lines, the simplified design method described in DIN EN 806-3 can be used for calculations. The Uponor HSE calculation software is available for calculation using the differentiated calculation method.

Uponor Aquastrom T PLUS



Uponor Aquastrom T plus is a thermostatic valve with pre-sets for circulation lines in accordance with DIN 1988-300 and DVGW worksheet W551. It controls the circulation water temperature within the recommended control range of 55 °C to 60 °C (max. control range 40 °C to 65 °C; control accuracy ± 1 °C).

The valve automatically supports thermal disinfection. The volume flow increases about 6 K above the set temperature and decreases – independent of the set temperature – from about 73 °C in the residual volume flow. The valve thus optimally supports the thermal disinfection of the circulation system. The max. volume flow rate can be pre-set and shut off independently of the set control temperature.

The valve, with a bronze body, is equipped with a drain valve with a hose tap, which can be used to drain the circulation line for maintenance. Temperature monitoring is possible using a thermometer or temperature sensor. The temperature setting can be secured against adjustment using a sealing cap. The set temperature value can still be read off.

Technical data

Description	Value	
Max. operating temperature	90 °C	
Nominal pressure	16 bar	
Factory settings	Temperature	57 °C
	Flow rate setting	DN 15: 2.0

Uponor Aquastrom T PLUS benefits

- Automatic thermal control of the flow rate
- Supports thermal disinfection
- Volume flow increases about 6 K above the set temperature, quickly reaching disinfection temperature in the line bundle
- Restricts the volume flow again above 73 °C to ensure disinfection of other parts of the system
- High corrosion resistance
- Temperature setting can also be read with sealing cap on
- Subsequent lead sealing possible
- Temperature monitoring with thermometer or temperature sensor (accessory) supported for integration into building management system
- Max. volume flow can be pre-set independently of the set control temperature and switched off for maintenance purposes
- With integrated drain valve for hose tap
- DVGW-certified

7.4 Use of trace heating



Caution!

The pressure increase in system parts due to the heating cable used must be observed. Suitable safety measures must be provided to ensure pressure equalisation. The installation guidelines and instructions of the trace heating cable manufacturer must be followed.

Uponor composite pipes are generally suitable fuse of trace heatings. The internal aluminium tube ensures uniform heat distribution around the pipe; the manufacturer's normal temperature limit of 60 °C must be taken into account. The heating cable must be attached in accordance with the manufacturer's instructions, whereby the Uponor composite pipe is to be classified as a plastic pipe.

If Uponor composite pipes are fitted with an trace heating cable, it must be ensured that the water can expand accordingly. If this is not

the case, e.g. for storage tank outlets to the hot water manifold, for short distances to the tapping points or for risers which only bridge one storey, damage to the Uponor pipe due to the high pressure rise cannot be ruled out.

In such cases, appropriate safety measures, such as the installation of a suitable safety valve or a corresponding diaphragm expansion vessel, must be taken.

7.5 Connections

Connection to through flow heater

Due to their design, hydraulically controlled electric and gas-fired through flow heaters can build up unacceptably high temperatures and pressures during normal operation and in the event of a fault, which can cause damage to the pipe system. Uponor installation pipe systems may only be connected directly to electronically controlled devices. When using electronically controlled devices for tap water heating, the manufacturer's instructions must be observed.

Connection to hot water tank

In general, when connecting to hot water storage tanks (especially directly fired hot water storage tanks, solar storage tanks and special designs), it must be ensured that in both normal operation and in the event of a malfunction the maximum operating limits of Uponor installation pipes are not exceeded. This applies in particular to the maximum hot water outlet temperature, which must be checked during commissioning or requested from the manufacturer. In case of doubt, suitable safety measures (such as the installation of a service water mixing valve) must be provided.

Fitting connections

Fitting connections must always be mounted so as to be twist-proof.

7.6 Moisture protection

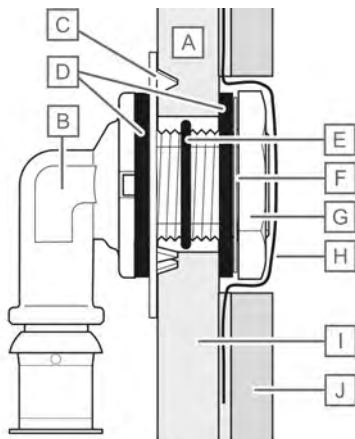

Professionally sealed Uponor S-Press PLUS U corner wall seal LWC with Uponor LWC mounting kit and Uponor LWC sealing flange

Item	Description
A	Drywall planking (here: plasterboard)
B	Uponor S-Press PLUS tap elbow LWC
C	Uponor anti-twist device LWC
D	Seal

Item	Description
E	Centring rubber ring
F	Pressure washer
G	Fitting nut
H	Uponor sealing flange LWC
I	Tile adhesive with waterproofing provided inside
J	Tiles

The required moisture protection in sanitary facilities is regulated in DIN 18534 "Waterproofing of interior spaces". The following designs are limited to moisture protection in the area of sanitary fittings and seals, for example in the area of drywall facing.

Moisture protection around sanitary fittings and seals

In the case of in-wall fittings, the sealing to the brickwork or to drywall facing must be provided with a moisture seal suitable for the fitting. The tiler incorporates these into a surface seal in accordance with recognised engineering practices.

8 Pipe network calculations according to DIN 1988-300

8.1 General information

The calculation of drinking water distribution systems is carried out according to the calculation principles of DIN 1988-300: "Technical Rules for drinking water distribution Systems – Determination of Pipe Diameters DVGW Technical Rules".

Dimensioning of cold and hot water pipes according to DIN 1988-300

The pipe diameters of all sections of the drinking water system are determined by the following steps:

- Determine the calculated flow rates of the tap fittings and determine the total flow rates for each section
- Calculate the peak flow rate
- Calculate available pipe friction pressure gradient for all flow paths
- Select the pipe diameter for the most unfavourable flow path
- Select the new available pressure drop and then the pipe diameter for the next most unfavourable flow path
- Repeat step 5 until all sections have been dimensioned

8.2 Planning reliability with Uponor HSE

HSE-san: For hygienically perfect drinking water distribution

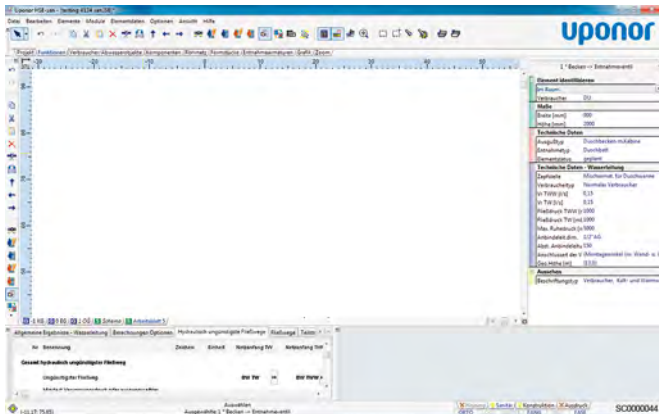

For the implementation of the European series of standards EN 806 for the planning, execution and operation of drinking water distribution systems, DIN 1988-300 for the dimensioning of economical and hygienically perfect drinking water distribution systems was published in 2012. Hygiene aspects such as avoiding stagnation required a reduction in the peak volume flow calculation. A further significant aspect of the amendment is the fact that the series and loop lines currently used on the same storey could not be adequately modelled so far.

In order to be able to calculate the exact pressure loss based on the system, the resistance coefficients of the shaped and connecting pieces must now also be measured and taken into account depending on the product.

Planning reliability through differentiated calculation

In the current version, we provide you with a comprehensive update to the latest version of DIN 1988-300.

All zeta values in Uponor installation systems are stored in accordance with standards. For product-neutral tenders, the reference values for resistance coefficients from the Annex to the standard can be taken into account. The software supports the simple, automated definition of usage units and the dimensioning and display of loop-through installations. In addition to schematic representations, the current HSE version also allows planning in the ground plan. This makes it easy to generate Datanorm BOMs and tenders.

Scope of services

- Dimensioning of drinking water distribution systems according to DIN 1988-300
- Product-specific measured zeta values integrated
- Automated definition of usage units in floor plan and schema
- Calculation of the display of ring and row loop-through installations
- Quick overview of information by section (temperature circulation)
- Planning of decentralised tap water heating with fresh water installations (consideration of simultaneity in the hot water network)

8.3 Data for pipe network calculations

Uponor S-Press PLUS – zeta values*

Single resistance			S-Press PLUS fittings				S-Press PLUS composite fittings made of PPSU			
			Zeta values ζ				Zeta values ζ			
			DN 12	DN 15	DN 20	DN 25	DN 12	DN 15	DN 20	DN 25
			Pipe outer diameter OD mm				Pipe outer diameter OD mm			
			16	20	25	32	16	20	25	32
T-joint branch for current separation	TA		7,4	5,2	4,7	3,4	16,5	8,8	7,4	5,8
T-joint passage for current separation	TD		2,3	1,2	1,1	0,7	4,4	2,8	2,4	1,2
T-joint counter-flow for current separation	TG		7,6	5,4	5	4,1	17,1	9,1	7,9	6,2
T-joint branch for current merging	TVA		13,2	8,1	7,7	6,7	29,1	15,7	15,6	10,6
T-joint passage for current merging	TVD		26,4	21,2	17,1	14,7	58,2	32,7	30,4	20,9
T-joint counter-flow for current merging	TVG		18	12,1	10,6	7,9	36	18,3	16,2	11,5
Bend 90°	B90		4,1	2,6	2,2	1,6	—	—	—	—
Angle 90°	W90		7,1	5,1	4,2	3,3	10,4	5,1	4,1	3,1
Angle/Bend 45°	W45		—	—	2,3	1,3	—	—	—	—
Reduction	RED		1,6	0,7	1,1	—	—	—	—	—
Wall bracket	WS		6,5	4,3	3,4	—	—	—	—	—
Double wall bracket passage	WSD		6,3	4,2	3,9	—	—	—	—	—
Double wall bracket branch	WSA		4,3	4,2	5,5	—	—	—	—	—
Coupling/sleeve	K		1,9	1	0,8	0,5	3,4	1,7	1,6	0,8

* Product-related Uponor resistance coefficients according to DIN 1988-300 point 4.3 Individual resistances. The resistance coefficients (ζ values) cited by the manufacturers as calculated in accordance

with DVGW Worksheet W 575 or equivalent procedures shall be taken into account.

Uponor S-Press – zeta values*

Single resistance			S-Press fittings		S-Press composite fittings made of PPSU			
			Zeta values ζ		Zeta values ζ			
			DN 32	DB 40	DB 32	DN 40	DN 50	DN 65
			Pipe outer diameter OD mm		Pipe outer diameter OD mm			
			40	50	40	50	63	75
T-joint branch for current separation	TA		4,1	3,1	5,5	4,4	5,2	5,0
T-joint passage for current separation	TD		0,7	0,4	1,0	0,7	1,2	1,2
T-joint counter-flow for current separation	TG		4,1	3,1	6,1	4,8	6,7	6,3
T-joint branch for current merging	TVA		7,8	5,6	12,1	9,4	12,6	11,8
T-joint passage for current merging	TVD		13,8	11,4	22,8	18,8	25,5	26,0

Single resistance			S-Press fittings		S-Press composite fittings made of PPSU			
			Zeta values ζ		Zeta values ζ			
			DN 32	DB 40	DB 32	DN 40	DN 50	DN 65
			Pipe outer diameter OD mm		Pipe outer diameter OD mm			
			40	50	40	50	63	75
T-joint counter-flow for current merging	TVG		12,2	10,9	12,4	9,7	13,5	12,7
Angle 90°	W90		2,4	1,8	5,1	4,3	4,4	3,8
Angle/Bend 45°	W45		1,3	1,2	2,1	2,0	1,7	1,7
Reduction	RED		1,2	1,0	0,9	1,3	1,2	1,0
Coupling/sleeve	K		0,5	0,3	0,8	0,6	0,6	0,6

* Product-related Uponor resistance coefficients according to DIN 1988-300 point 4.3 Individual resistances. The resistance coefficients (ζ values) cited by the manufacturers as calculated in accordance

with DVGW Worksheet W 575 or equivalent procedures shall be taken into account.

Uponor RS – zeta values*

			Zeta values ζ					
			DN 32	DN 40	DN 50	DN 65	DN 80	DN 100
			Pipe outer diameter OD mm					
			40	50	63	75	90	110
T-joint branch for current separation	TA		1,0	1,4	2,5	3,2	2,8	2,8
T-joint passage for current separation	TD		0,7	0,5	1,0	0,7	0,2	0,2
T-joint counter-flow for current separation	TG		3,5	3,0	3,1	4,1	4,0	4,0
T-joint branch for current merging	TVA		5,5	4,5	4,0	3,5	3,5	3,5
T-joint passage for current merging	TVD		10,0	9,0	8,0	7,0	6,0	6,0
T-joint counter-flow for current merging	TVG		8,0	7,0	6,0	5,0	5,0	5,0
Angle 90°	W90		—	—	2,3	3,1	2,4	2,4
Angle/Bend 45°	W45		—	—	1,0	1,0	1,0	1,5
Reduction	RED		0,6	0,5	0,5	0,3	0,0	—
Coupling/sleeve	K		—	—	0,8	0,6	0,0	0,0

* Product-related Uponor resistance coefficients according to DIN 1988-300 point 4.3 Individual resistances. The resistance coefficients (ζ values) cited by the manufacturers as calculated in accordance

with DVGW Worksheet W 575 or equivalent procedures shall be taken into account.

Dimensioning of sections (design tables)

The selection of the pipe dimension for a section can be determined from the following pipe friction pressure gradient tables described as functions of peak flow rate for cold tap water (10 °C), or from the pressure loss diagram.

The required rules for the dimensioning of pipes, the required minimum flow pressures and calculated flows can be found in DIN 1988-300.

Pipe dimensions 14 — 20 mm

OD x s (ID) — V/l	14 x 2 mm (10 mm) — 0.078 l/m		16 x 2 mm (12 mm) — 0.11 l/m		20 x 2,25 mm (15,5 mm) — 0.19 l/m	
\dot{V}_s — l/s	v — m/s	R — mbar/m	v — m/s	R — mbar/m	v — m/s	R — mbar/m
0.01	0.13	0.51	0.09	0.22	0.05	0.07
0.02	0.25	1.61	0.18	0.69	0.11	0.21
0.03	0.38	3.19	0.27	1.36	0.16	0.41
0.04	0.51	5.21	0.35	2.21	0.21	0.66
0.05	0.64	7.62	0.44	3.23	0.26	0.97
0.06	0.76	10.43	0.53	4.41	0.32	1.32
0.07	0.89	13.59	0.62	5.75	0.37	1.72
0.08	1.02	17.12	0.71	7.23	0.42	2.16
0.09	1.15	20.99	0.80	8.86	0.48	1.91
0.10	1.27	25.20	0.88	10.63	0.53	3.17
0.15	1.91	51.07	1.33	21.49	0.79	6.39
0.20	2.55	84.56	1.77	35.52	1.06	10.54
0.25	3.18	125.23	2.21	52.55	1.32	15.56
0.30	3.82	172.79	2.65	72.43	1.59	21.41
0.35	4.46	227.01	3.09	95.07	1.85	28.07
0.40	5.09	287.69	3.54	120.39	2.12	35.52
0.45	5.73	354.68	3.98	148.33	2.38	43.72
0.50	6.37	427.86	4.42	178.83	2.65	52.67
0.55	7.00	507.11	4.86	211.85	2.91	62.35
0.60	-	-	5.31	247.33	3.18	72.74
0.65	-	-	5.75	285.24	3.44	83.84
0.70	-	-	6.19	325.56	3.71	95.64
0.75	-	-	6.63	368.25	3.97	108.13
0.80	-	-	7.07	413.27	4.24	121.29
0.85	-	-	-	-	4.50	135.12
0.90	-	-	-	-	4.77	149.62
0.95	-	-	-	-	5.03	164.77
1.00	-	-	-	-	5.30	180.57
1.05	-	-	-	-	5.56	197.02
1.10	-	-	-	-	5.83	214.11
1.15	-	-	-	-	6.09	231.84
1.20	-	-	-	-	6.36	250.19
1.25	-	-	-	-	6.62	269.17
1.30	-	-	-	-	6.89	288.77
1.35	-	-	-	-	7.15	308.99

\dot{V}_s = Peak flow rate in litres/second according to DIN 1988-300

R = Pipe friction pressure gradient in millibar/metre (1 mbar = 1 hPa)

v = Flow velocity in metres/second

Correction factors for other water temperatures

Water temperature [°C]	10	15	20	25	30	35	40	45	50	55	60
Conversion factor	1.000	0.983	0.967	0.952	0.938	0.933	0.918	0.904	0.890	0.873	0.861

Pipe dimensions 25 — 50 mm

OD x s (ID) — V/l	25 x 2,5 mm (20 mm) — 0.31 l/m		32 x 3 mm (25 mm) — 0.53 l/m		40 x 4 mm (32 mm) — 0.80 l/m		50 x 4,5 mm (40 mm) — 1.32 l/m	
\dot{V}_s — l/s	v — m/s	R — mbar/m	v — m/s	R — mbar/m	v — m/s	R — mbar/m	v — m/s	R — mbar/m
0.10	0.32	0.95	0.19	0.28	0.12	0.10	0.08	0.03
0.20	0.64	3.15	0.38	0.91	0.25	0.34	0.15	0.11
0.30	0.95	6.38	0.57	1.84	0.37	0.69	0.23	0.21
0.40	1.27	10.55	0.75	3.03	0.50	1.13	0.30	0.35
0.50	1.59	15.62	0.94	4.48	0.62	1.67	0.38	0.52
0.60	1.91	21.55	1.13	6.17	0.75	2.30	0.45	0.71
0.70	2.23	28.30	1.32	8.10	0.87	3.01	0.53	0.93
0.80	2.55	35.86	1.51	10.25	0.99	3.81	0.61	1.17
0.90	2.86	44.20	1.70	12.63	1.12	4.69	0.68	1.44
1.00	3.18	53.30	1.88	15.22	1.24	5.65	0.76	1.73
1.10	3.50	63.16	2.07	18.02	1.37	6.69	0.83	2.05
1.20	3.82	73.76	2.26	21.03	1.49	7.80	0.91	2.39
1.30	4.14	85.08	2.45	24.24	1.62	8.99	0.98	2.76
1.40	4.46	97.12	2.64	27.66	1.74	10.25	1.06	3.14
1.50	4.77	109.88	2.83	31.28	1.87	11.59	1.14	3.55
1.60	5.09	123.33	3.01	35.09	1.99	13.00	1.21	3.98
1.70	-	-	3.20	39.10	2.11	14.48	1.29	4.43
1.80	-	-	3.39	43.30	2.24	16.03	1.36	4.90
1.90	-	-	3.58	47.69	2.36	17.65	1.44	5.40
2.00	-	-	3.77	52.27	2.49	19.34	1.51	5.91
2.10	-	-	3.96	57.04	2.61	21.10	1.59	6.45
2.20	-	-	4.14	61.99	2.74	22.92	1.67	7.00
2.30	-	-	4.33	67.13	2.86	24.82	1.74	7.58
2.40	-	-	4.52	72.45	2.98	26.78	1.82	8.18
2.50	-	-	4.71	77.96	3.11	28.81	1.89	8.79
2.60	-	-	4.90	83.64	3.23	30.90	1.97	9.43
2.70	-	-	5.09	89.50	3.36	33.06	2.05	10.09
2.80	-	-	-	-	3.48	35.28	2.12	10.76
2.90	-	-	-	-	3.61	37.57	2.20	11.46
3.00	-	-	-	-	3.73	39.93	2.27	12.17
3.50	-	-	-	-	4.35	52.65	2.65	16.04
4.00	-	-	-	-	4.97	66.93	3.03	20.37
4.50	-	-	-	-	5.60	82.73	3.41	25.17
5.00	-	-	-	-	-	-	3.79	30.41
5.50	-	-	-	-	-	-	4.17	36.09
6.00	-	-	-	-	-	-	4.54	42.22
6.50	-	-	-	-	-	-	4.92	48.77
7.00	-	-	-	-	-	-	5.30	55.74
7.50	-	-	-	-	-	-	5.68	63.13
8.00	-	-	-	-	-	-	6.06	70.94
8.50	-	-	-	-	-	-	6.44	79.16
9.00	-	-	-	-	-	-	6.82	87.78

\dot{V}_s = Peak flow rate in litres/second according to DIN 1988-300

R = Pipe friction pressure gradient in millibar/metre (1 mbar = 1 hPa)

v = Flow velocity in metres/second

Pipe dimensions 63 — 110 mm

OD x s (ID) — V/l	63 x 6 mm (51 mm) — 2.04 l/m		75 x 7,5 mm (60 mm) — 2.83 l/m		90 x 8,5 mm (73 mm) — 4.18 l/m		110 x 10 mm (90 mm) — 6.36 l/m	
\dot{V}_s — l/s	v — m/s	R — mbar/m	v — m/s	R — mbar/m	v — m/s	R — mbar/m	v — m/s	R — mbar/m
1.00	0.49	0.61	0.35	0.28	0.24	0.11	0.16	0.04
1.25	0.61	0.91	0.44	0.42	0.30	0.17	0.20	0.06
1.50	0.73	1.25	0.53	0.58	0.36	0.23	0.24	0.08
1.75	0.86	1.65	0.62	0.76	0.42	0.30	0.28	0.11
2.00	0.98	2.08	0.71	0.96	0.48	0.38	0.31	0.14
2.25	1.10	2.57	0.80	1.18	0.54	0.46	0.35	0.17
2.50	1.22	3.10	0.88	1.43	0.60	0.56	0.39	0.21
2.75	1.35	3.67	0.97	1.69	0.66	0.66	0.43	0.24
3.00	1.47	4.28	1.06	1.97	0.72	0.77	0.47	0.28
3.25	1.59	4.94	1.15	2.27	0.78	0.89	0.51	0.33
3.50	1.71	5.64	1.24	2.59	0.84	1.01	0.55	0.37
3.75	1.84	6.38	1.33	2.93	0.90	1.15	0.59	0.42
4.00	1.96	7.16	1.41	3.29	0.96	1.29	0.63	0.47
4.25	2.08	7.98	1.50	3.66	1.02	1.43	0.67	0.53
4.50	2.20	8.84	1.59	4.06	1.08	1.59	0.71	0.58
4.75	2.33	9.73	1.68	4.47	1.13	1.75	0.75	0.64
5.00	2.45	10.67	1.77	4.90	1.19	1.92	0.79	0.70
6.00	2.94	14.80	2.12	6.79	1.43	2.65	0.94	0.97
7.00	3.43	19.53	2.48	8.95	1.67	3.49	1.10	1.28
8.00	3.92	24.84	2.83	11.38	1.91	4.44	1.26	1.63
9.00	4.41	30.71	3.18	14.07	2.15	5.49	1.41	2.01
10.00	4.90	37.15	3.54	17.01	2.39	6.63	1.57	2.43
11.00	5.38	44.13	3.89	20.20	2.63	7.87	1.73	2.88
12.00	-	-	4.24	23.63	2.87	9.21	1.89	3.37
13.00	-	-	4.60	27.31	3.11	10.63	2.04	3.89
14.00	-	-	4.95	31.23	3.34	12.16	2.20	4.45
15.00	-	-	5.31	35.38	3.58	13.77	2.36	5.03
16.00	-	-	5.66	39.77	3.82	15.47	2.52	5.65
17.00	-	-	6.01	44.39	4.06	17.27	2.67	6.31
18.00	-	-	-	-	4.30	19.15	2.83	6.99
19.00	-	-	-	-	4.54	21.12	2.99	7.71
20.00	-	-	-	-	4.78	23.17	3.14	8.46
21.00	-	-	-	-	5.02	25.31	3.30	9.24
22.00	-	-	-	-	5.26	27.54	3.46	10.05
23.00	-	-	-	-	5.50	29.86	3.62	10.89
24.00	-	-	-	-	5.73	32.25	3.77	11.77
25.00	-	-	-	-	-	-	3.93	12.67
26.00	-	-	-	-	-	-	4.09	13.60
27.00	-	-	-	-	-	-	4.24	14.57
28.00	-	-	-	-	-	-	4.40	15.56
29.00	-	-	-	-	-	-	4.56	16.58
30.00	-	-	-	-	-	-	4.72	17.63

\dot{V}_s = Peak flow rate in litres/second according to DIN 1988-300

R = Pipe friction pressure gradient in millibar/metre (1 mbar = 1 hPa)

v = Flow velocity in metres/second

Pressure loss diagram, cold tap water (10 °C)

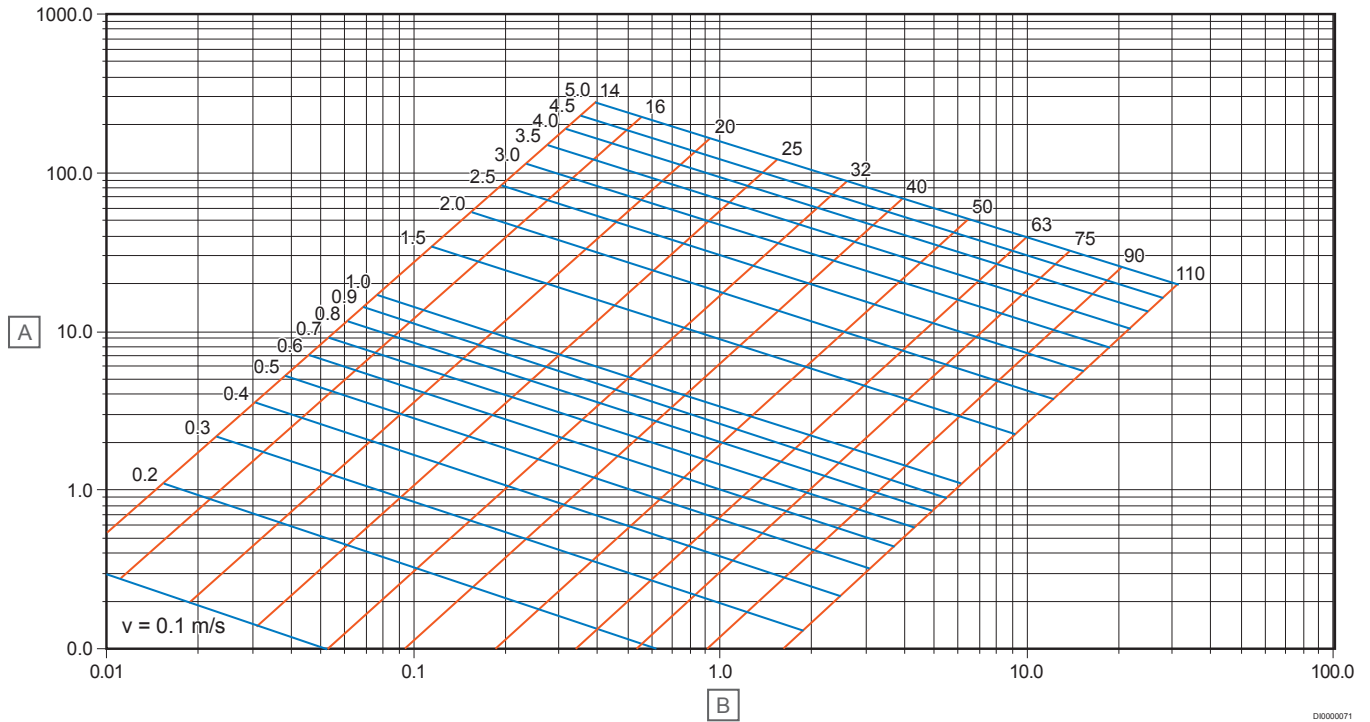

Item	Description
A	Pipe friction pressure gradient R [mbam/m]

Item	Description
B	Volume flow rate \dot{V}_s [l/s]

Correction factors for other water temperatures

Water temperature [°C]	10	15	20	25	30	35	40	45	50	55	60
Conversion factor	1.000	0.983	0.967	0.952	0.938	0.933	0.918	0.904	0.890	0.873	0.861

9 Leak test, initial filling and commissioning

9.1 Pressure and leak testing

Note

Legal notice:

Pressure tests are ancillary services under a work contract and part of the Contractor's contractual performance, even if not explicitly mentioned in the description of services.

According to current standards a pressure test must be carried out before the system is put into operation.

Just as for any drinking water distribution, the Uponor installation system must also undergo a pressure test in accordance with DIN EN 806-4 or ZVSHK leaflet "Leak tests of drinking water distribution systems with compressed air, inert gas or water". Before the pressure test, it must be ensured that all components of the installation are freely accessible and visible, for example in order to locate incorrectly installed fittings. If the pipeline system is to remain unfilled after a pressure test (for example because regular water replacement cannot be guaranteed after seven days at the latest), a pressure test with compressed air or inert gases is recommended.

Leak test with compressed air or inert gas

After a leak test with water, residual water can remain in some sections of the pipeline network despite thorough emptying of the system – in case of prolonged stagnation, this is an ideal breeding ground for bacteria. For this reason, leak testing with oil-free compressed air or inert gas (usually nitrogen or carbon dioxide) is recommended, especially in buildings with high hygiene requirements such as hospitals, retirement homes or sport facilities. The system is first subjected to a leak test and only then – if possible only shortly before commissioning – is it flushed and filled with filtered tap water for the first time.

A pressure test with compressed air or inert gases is carried out in two steps, the tightness test and the load test, taking recognised engineering practices into consideration. For both tests, it is important

to wait for the temperature compensation and steady-state condition after the pressure build-up, after which the test period begins. Appliances, drinking water heaters, fittings or pressure vessels must be disconnected from the pipelines before a pressure test with air if their volume can affect safety and testing accuracy. All lines must be directly sealed using metal plugs, metal washers or blind flanges which can withstand the test pressure. Closed shut-off valves are not sufficient as tight shut-offs.

Leak test

Before the leak test, all pipe connections must be visually inspected. The manometer used in the test must have a corresponding accuracy of 1 mbar in the indication range for the pressures to be measured. The system is subjected to a test pressure of 150 mbar (150 hPa). For a system volume of up to 100 litres, the test time must be at least 120 minutes. The required time must be extended by a further 20 minutes per additional 100 litres. No leakage must occur at the connectors during the test.

Load test

Following the leak test, the load test is carried out. Here the pressure is increased to max. 3 bar (for pipe size OD ≤ 63 mm) or max. 1 bar (for pipe size OD > 63 mm). For a system volume of up to 100 litres, the test time must be at least 10 minutes.

Leak test report

The leak test must be documented in a leak test report by the responsible specialist, taking into account the materials used. The tightness of the system must be verified and confirmed.

This report is available at the Uponor services download center.

<https://www.uponor.com/doc/1120118>



Leak test with water

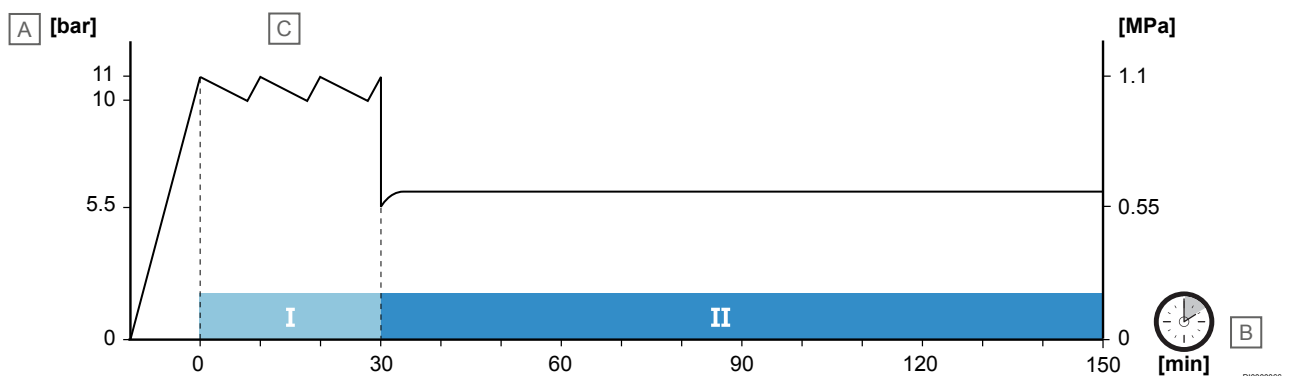

Item	Description
A	Test pressure [bar]
B	Test time [minutes]
C	Maintain pressure, pump

Preparing for the leak test

Before performing a leak test with water, a visual inspection of all pipe connections completed but not yet concealed must be carried out. The pressure gauge must be connected to the lowest point of the installation to be tested. Only measuring instruments that can reliably register a pressure difference of 0.1 bar may be used. The installation

must be filled with filtered tap water (particle size $\leq 150 \mu\text{m}$), vented and protected from freezing. Shut-off devices upstream and downstream of heat generators and storage tanks must be closed so that the test pressure is kept away from the rest of the installation.

If there are significant differences ($> 10 \text{ K}$) between ambient temperature and the water temperature, wait 30 minutes after applying system test pressure to allow temperature equalisation. The pressure must be maintained for at least 10 minutes. There must be no drop in pressure and no visible indication of leakage.

Uponor fittings with unpressed-untight function

In order to detect a leaking unpressed connection, Uponor fittings with "unpressed-untight" function must be tested at 3 bar for 15 minutes before the actual leak test.

Carrying out the leak test

The pipe network must first be subjected to a test pressure 1.1 times the operating pressure (relative to the lowest point of the system). The operating pressure according to DIN EN 806-2 is 10 bar (1 MPa). Accordingly, a test pressure of 11 bar (1.1 MPa) is required. Afterwards an inspection of the tested pipe section must be carried out in order to detect possible leaks.

After 30 minutes test time, reduce the pressure to 5.5 bar (0.55 MPa), corresponding to half the initial test pressure, by draining water. The test time at this pressure is 120 minutes. No leakage may be detectable during this test period. The test pressure at the manometer must remain constant ($\Delta p = 0$). If a pressure drop occurs during the test period, there is a leak in the system. Maintain pressure and locate the leak. The defect must be repaired and then the leak test must be repeated.

Leak test report

The leak test must be documented in a leak test report by the responsible specialist, taking into account the materials used. The tightness of the system must be verified and confirmed.

This report is available at the Uponor services download center.

<https://www.uponor.com/doc/1120119>



9.2 Flushing of Uponor drinking water distribution

Note

Uponor tap water lines must be flushed with the local supply pressure and in accordance with DIN EN 806-4, Section 6.2.2, unless a different flushing procedure is contractually agreed or required.

The tap water used for flushing must be filtered (filter according to DIN EN 13443-1).

Flushing must only take place immediately before the actual start-up.

To ensure unrestricted operational safety, the flushing process must remove contaminants and assembly residues from the internal surfaces of the pipes and system components. It secures tap water quality and prevents corrosion damage as well as malfunctions of valves or equipment.

The flushing procedure

The procedure is based on a pulsating current of water and air and is described in more detail in the technical rules for drinking water distribution systems, DIN EN 806-4 Section 6.2.3. Suitable flushing equipment must be used for this purpose. The flushing procedure should be used when a sufficient flushing effect cannot be expected when flushing with water.

Flushing method with water

Uponor tap water lines must be flushed to the local supply pressure using the water flushing procedure in accordance with DIN EN 806-4, Section 6.2.2, unless another flushing procedure is contractually agreed or required. The procedure for pipeline flushing corresponds to the specifications in the ZVSHK brochure "Flushing, disinfecting and commissioning drinking water distribution systems". This brochure is available from the Zentralverband Sanitär Heizung Klima, Rathausstrasse 6, 53757 St. Augustin and applies to drinking water distribution systems according to DIN 1988 and DIN EN 806. Further details and information on the flushing procedure with water can be found in the leaflet. The tap water used for flushing must be filtered (filter according to DIN EN 13443-1).

Points to consider:

- Sensitive fittings (such as solenoid valves, flush valves, thermostatic fittings etc.) and apparatus (such as water heaters) should only be installed after flushing. That prevents damage caused by contaminants and assembly residues.
- Aerators, jet regulators, flow-limiters, shower heads and hand showers must be disassembled during flushing if valves are already installed.
- For in-wall thermostatic fittings and other sensitive fittings which cannot be removed during flushing, the installation instructions of the manufacturer must be followed.
- All maintenance fittings, floor shut-offs and preliminary shut-offs (such as corner valves) must be fully open.
- Any built-in pressure reducers must be fully open and are only adjusted after flushing.
- Built-in fine sieves in front of fittings that cannot be removed or bridged must be cleaned after flushing.

Depending on the size of the system and the line layout, flushing must be carried out in sections.

Maintain a flushing direction from the main shut-off valve, flushing each section line by line (from nearest to the most distant). Starting from the end of the riser, flushing is carried out floor by floor.

Fully open the tapping points (see table in the following flushing protocol for the minimum number) within the floor and individual supply lines for at least 5 minutes each, one after the other.

Within one storey, the tapping points are fully opened, starting at the tapping point furthest from the riser. After a flushing time of 5 minutes at the last opened flushing point, the taps are closed one after the other in reverse order.

Flushing protocol

The flushing process must be documented by the responsible specialist in a flushing protocol.

This report is available at the Uponor services download center.

<https://www.uponor.com/doc/1120120>



10 Handover and documentation

According to the requirements of the Drinking Water Ordinance, the operator and other owners of the drinking water distribution system are responsible for the proper operation of the system. In order to fulfill his obligations, the system manufacturer is obliged to instruct the operator in the system. In addition, at least the following documents are to be handed over to him:

- Room data sheet with description of use and concept of the drinking water distribution system
- Commissioning and instruction protocol
- Leak test and flushing protocols
- Protocol for regulating the hot water system
- Test results for the cold and hot water installation
- Inspection and maintenance plan (DIN EN 806, part 5)
- Manufacturer's documents, assembly and operating documents
- Plans and floor plans of the building with system diagram
- If applicable, information on substances that are added to tap water in case of increased hygiene requirements (VDI/DVGW 6023)
- Maintenance and hygiene plan
- After commissioning, the following documents must also be submitted to the responsible health authority:
 - Flushing protocols and protocols for regulating the hot water installation
 - Test results of sampling (DVGW W 551)

11 Heating installation

11.1 System description



The versatile range of radiator connection components from Uponor includes everything that is required for a safe and quick connection from the heat source to the radiator. Uponor offers a complete range of products for all radiator connection variants - from the traditional single-pipe system with thermostatic valves to a complex distribution system with zone control.

With the Uponor composite pipe system, all common radiator connections can be realised – both from the floor and comfortably from the wall. The system also includes special components for the radiator connection from the baseboard, an important aspect in renovations, for example. In addition, pipes and components pre-insulated at the factory in accordance with EnEV requirements, such as the Uponor Smart radi connection block and the Uponor Smart radi cross fitting for S-Press in an insulation box, enable rapid construction progress and a high level of assembly safety.

Heating installation

- Wide range of components for different installation options
- Simple planning, low pressure loss
- Simple pressure drop determination and dimensioning

11.2 Uponor main components for heating (overview)

Uponor radiator adapters and T-joints



Tin-plated brass fittings with Uponor S-Press PLUS connection and coated or bare copper pipe 15 x 1 mm in lengths 365 and 1115 mm. Optionally for Uponor composite pipes 14 or 16 mm. Radiator connection via Uponor Smart radi compression adapter Cu.

Uponor radiator cross fitting in insulation box



RP0000181

Factory pre-insulated fitting made of coated brass with Uponor S-Press PLUS joint technology. Enables the crossing-free connection of radiators on the unfinished floor. Two-part insulation box made of EPP (expanded polypropylene) with 13 mm insulation, WLG 035. Meets EnEV requirements in the area of pipe crossings and feed-throughs (50 % insulation).

Uponor Smart radi connection block

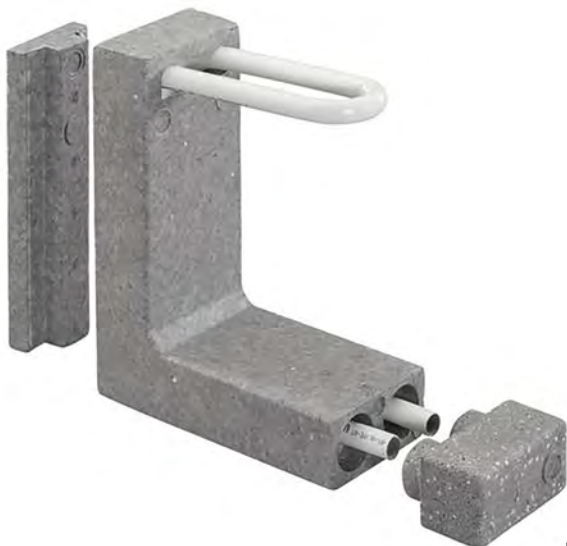

RP0000182

Wall connection cut out with polystyrene thermal insulation and removable protective cap. Insulation box in fire class E according to DIN EN 13501-1. Suitable for all common valve radiators. Insulation box width: 100 mm

Uponor radiator mounting plate



RP0000183

Factory pre-fabricated unit for radiator connection from unfinished floor, consisting of two Uponor S-Press PLUS wall brackets 16 — Rp½, mounted in anti-twist manner on Uponor mounting plate, optionally with 35 or 50 mm centre distance.

Uponor baseboard adapter



RP0000184

Connection kit made of coated brass and Uponor S-Press PLUS connection for baseboard installation without chiselling out the wall. Optionally for Uponor composite pipes with 16 or 20 mm outer diameter. Radiator connection with Uponor Smart Base angle.

Uponor manifold



Complete stainless steel manifold for the connection of 2-12 radiators. Primary connections 1" FT with flat seal. Heating circuit connection 3/4" external thread with euro-cone.

Uponor Uni fittings and transitions



Fittings range for 1/2" (Uni-C) or 3/4" (Uni-X) thread transitions

Uponor Smart radi connection kits



Coated brass fitting. Pressure screw with MT with support sleeve and clamping ring, O-ring made of EPDM. Suitable connection kits for Heimeier, Danfos or Oventrop radiator valves

Uponor Smart radi accessories



Fixing and assembly components for installing the Uponor Smart radi system

11.3 Planning principles for heating installation

Connection options

Uponor installation systems contain all the components required for radiator connection. The most common connection variants are shown below. When installing the systems, the system-specific special features and installation guidelines must be observed. These can be found in the respective technical system descriptions in this manual and in the associated installation instructions.

Two-pipe system with central heating manifold

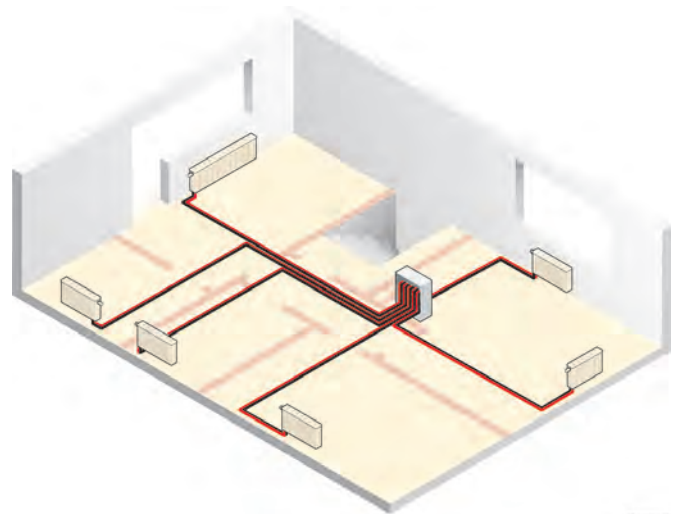

With the two-pipe system with central heating manifold, each radiator is connected individually. A heat meter can be mounted on the heating manifold, allowing heat to be measured for each apartment.

Two-pipe system with T-joint and elbow radiator connection

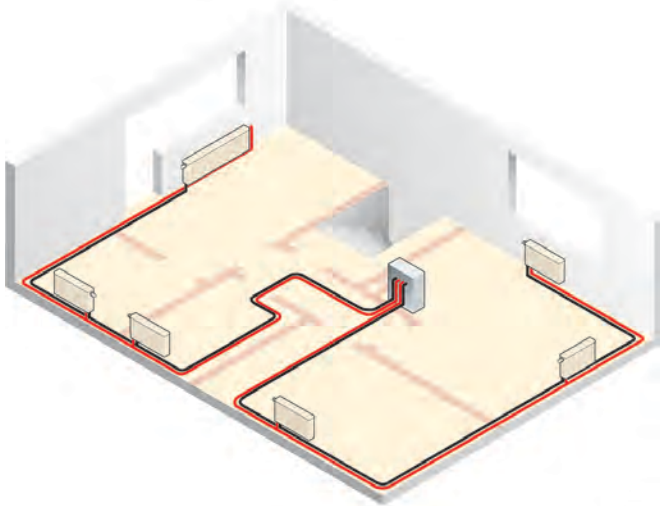

SD0000121

With the two-pipe system with T-joint radiator connection, loop lines with one or more radiators are connected individually from a central manifold/collector. A heat meter can be mounted on the heating manifold, allowing heat to be measured for each apartment.

Two-pipe system as loop line

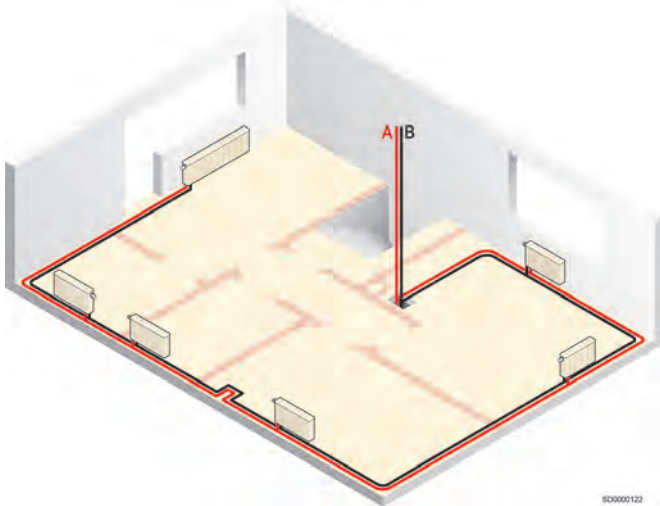

SD0000122

Item	Description
A	Supply
B	Return

With the two-pipe system as a loop line, the pipe routing for connecting the radiators to the riser begins and ends.

Two-pipe system as classic distribution system

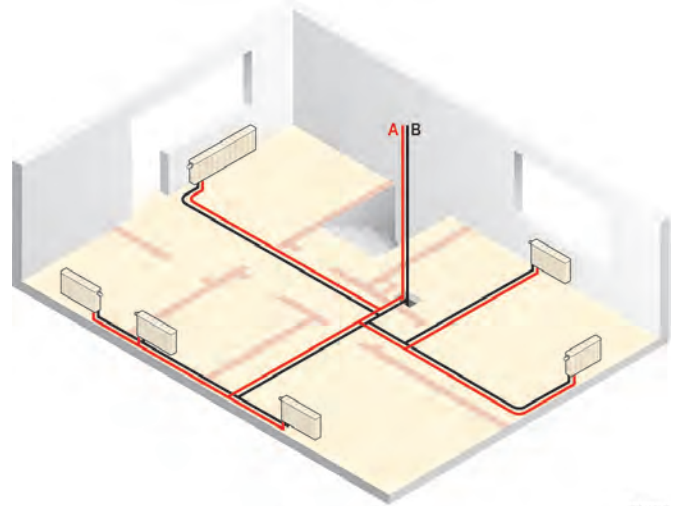

SD0000123

Item	Description
A	Supply
B	Return

In the two-pipe system as a classic distribution system with T-joints, almost all pipe layouts and combinations are possible. Line layout for connecting the radiators begins and ends at the riser.

Single-pipe system

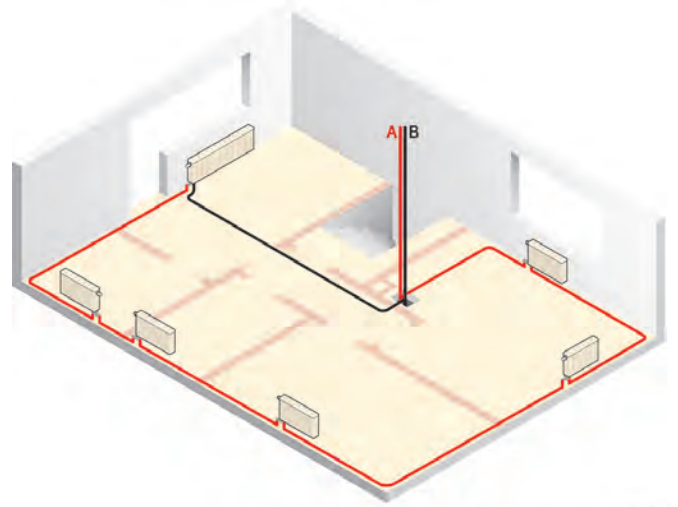

SD0000124

Item	Description
A	Supply
B	Return



In the single-pipe system, the pipe routing for connecting the radiators begins and ends at the riser.

11.4 Examples of radiator connections

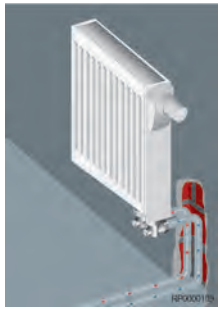

With the Uponor composite pipe system, all common radiator connections can be realised – both from the floor and comfortably from the wall. The system also includes special components for the radiator connection from the baseboard, an important aspect in renovations, for example. The most common connection variants are shown below with the components required for each radiator.

Two-pipe heating with manifold system



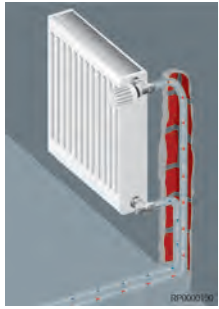

Uni-X screw connection MLC from the wall

	Number	Designation	Dimension
	Uponor Uni-X screw connection MLC		
	2 units	 <ul style="list-style-type: none"> Two-part screw connection made of brass, with tin-plated union nut and pressure sleeve For the direct connection of Uponor composite pipes, Uni Pipe PLUS and MLC, to 3/4 FT moulded euro-cone parts as well as manifold H Internal thread according to DIN EN ISO 228-1 Connect without deburring 	14-3/4"FT Euro 16-3/4"FT Euro 20-3/4"FT Euro

Uponor S-Press adapter nipple from the wall

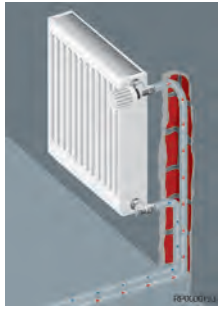



	Number	Designation	Dimension
	Uponor S-Press PLUS adapter nipple		
	2 units	 <ul style="list-style-type: none"> Flow optimised fitting Made of dezincing resistant brass, according to UBA positive list, tin-plated 	14-R1/2"MT 16-R1/2"MT 20-R1/2"MT

Uponor Smart radi connection kit from the wall

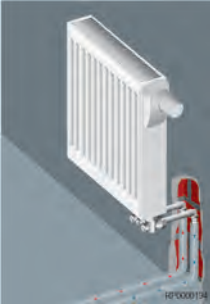

	Number	Designation	Dimension
	Uponor Smart radi connection kit Danfoss		
	2 units	 <ul style="list-style-type: none"> Brass coated Pressure screw with male thread with support sleeve and clamping ring, suitable for Danfoss radiator valves with female thread O-ring made of EPDM 	16-G1/2"MT
	Uponor Smart radi connection kit Heimeier		
2 units	 <ul style="list-style-type: none"> Brass coated Pressure screw with male thread with support sleeve and clamping ring, suitable for Heimeier radiator valves with female thread O-ring made of EPDM 	16-G1/2"MT	
Uponor Smart radi connection kit Oventrop			
2 units	 <ul style="list-style-type: none"> Brass coated Pressure screw with male thread with support sleeve and clamping ring, suitable for Oventrop radiator valves with female thread O-ring made of EPDM 	16-G1/2"MT	

Radiator with Uponor S-Press PLUS radiator elbow adapter from the wall





Variant 1

	Number	Designation	Dimension
	Uponor S-Press PLUS radiator elbow adapter		
	2 units	 <ul style="list-style-type: none"> Made of brass and coated copper tube The 15 mm copper pipe can be connected to the radiator using the Uponor Smart radi Cu compression adapter. 	14-15CU l=350mm 16-15CU l=350mm 16-15CU l=1000mm
	Uponor Smart radi compression adapter Cu		
	2 units	 <ul style="list-style-type: none"> With G$\frac{3}{4}$ euro-cone elastically sealing for the connection of coated copper pipes 15 x 1 mm of Uponor elbow adapters/T-joints to a tap block, radiator or Uponor radiator connecting nipple with G$\frac{3}{4}$ MT euro-cone Union nut brass coated, clamping ring brass bright and EPDM sealing cone Ribbed union nut with wrench size 30 	15CU- $\frac{3}{4}$ " Euro

Variant 2, like variant 1, but additionally



	Number	Designation	Dimension
	Uponor Smart radi connecting nipple		
	2 units	 <ul style="list-style-type: none"> Brass coated Self-sealing For connecting radiators with $\frac{1}{2}$ IG connections, $\frac{3}{4}$ MT euro-cone for connecting Cu pipe 15 x 1 mm with Uponor compression adapter Cu with $\frac{3}{4}$ euro-cone 	G $\frac{3}{4}$ "MT- G $\frac{1}{2}$ "MT

Valve radiator with Uponor S-Press PLUS radi mounting plate and Uponor Smart radi connecting pipes from the wall

	Number	Designation	Dimension
	Radi mounting plate		
	1 unit	 <ul style="list-style-type: none"> Prefabricated unit, consisting of two Uponor press wall brackets 16 - Rp$\frac{1}{2}$, pre-assembled at the factory on a Uponor mounting plate 35/50 mm, torsion-proof 	16-Rp $\frac{1}{2}$ "FT c/c 35 mm 16-Rp $\frac{1}{2}$ "FT c/c 50 mm
	Radi connection pipe		
	2 units	 <ul style="list-style-type: none"> Made of coated copper tube Copper pipe 15 x 1 mm with self-sealing thread for radiator connection Suitable for all Uponor press wall brackets and press wall brackets with internal thread Rp$\frac{1}{2}$ Connection to valve block, radiator or Uponor radiator connecting nipple is possible using the Uponor Cu compression adapter with euro-cone 	G $\frac{1}{2}$ "MT - 15CU l=350mm



Number	Designation	Dimension
Radi compression adapter Cu		
2 units	 <ul style="list-style-type: none"> With G$\frac{3}{4}$ euro-cone elastically sealing for the connection of coated copper pipes 15 x 1 mm of Uponor elbow adapters/T-joints to a tap block, radiator or Uponor radiator connecting nipple with G$\frac{3}{4}$ MT euro-cone Union nut brass coated, clamping ring brass bright and EPDM sealing cone Ribbed union nut with wrench size 30 	15CU- $\frac{3}{4}$ " Euro

Valve radiator with Uponor Smart radi connection block from the wall



Number	Designation	Dimension
Uponor Smart radi connection block		
1 unit	 <ul style="list-style-type: none"> Made of polystyrene with removable protective cap Insulation box in fire class E according to DIN EN 13501-1 Suitable for all common valve radiators 	16 h = 215 mm 16 h = 240 mm
Uponor S-Press PLUS coupling		
2 units	 <ul style="list-style-type: none"> Flow optimised fitting Made of dezincing resistant brass, according to UBA positive list, tin-plated 	16-16
Uponor S-Press PLUS coupling		
2 units	 <ul style="list-style-type: none"> Two-part screw connection made of brass, with tin-plated union nut and pressure sleeve For the direct connection of Uponor composite pipes, Uni Pipe PLUS and MLC, to $\frac{3}{4}$ MT moulded euro-cone parts as well as manifold H Internal thread according to DIN EN ISO 228-1 Connect without deburring 	16- $\frac{3}{4}$ "FT Euro

Radiator with Uponor S-Press PLUS radiator elbow adapter from the floor





Variant 1

Number	Designation	Dimension
Uponor S-Press PLUS radiator elbow adapter		
2 units	 <ul style="list-style-type: none"> Made of brass and coated copper tube The 15 mm copper pipe can be connected to the radiator using the Uponor Smart radi Cu compression adapter. 	14-15CU l=350 mm 16-15CU l=350 mm 16-15CU l=1000 mm
Uponor Smart radi compression adapter Cu		
2 units	 <ul style="list-style-type: none"> With G$\frac{3}{4}$ euro-cone elastically sealing for the connection of coated copper pipes 15 x 1 mm of Uponor elbow adapters/T-joints to a tap block, radiator or Uponor radiator connecting nipple with G$\frac{3}{4}$ MT euro-cone Union nut brass coated, clamping ring brass bright and EPDM sealing cone Ribbed union nut with wrench size 30 	15CU- $\frac{3}{4}$ " Euro

Variant 2, like variant 1, but additionally

	Number	Designation	Dimension
	Uponor Smart radi connecting nipple		
	2 units	 <ul style="list-style-type: none"> • Brass coated • Self-sealing • For connecting radiators with ½ IG connections, ¾ MT euro-cone for connecting Cu pipe 15 x 1 mm with Uponor compression adapter Cu with ¾ euro-cone 	G¾"MT- G½"MT





Valve radiator with Uponor Uni-X screw MLC connection and Uponor Smart radi connection kit

	Number	Designation	Dimension
	Uponor Smart radi connection kit		
	1 unit	 <ul style="list-style-type: none"> • Made of plastic • For quick, clean fixing of Uponor composite pipes 16 x 2 mm to the radiator • Comprising: bottom bracket, pipe holder for different valve spacings (centre distance: 50, 45, 40, 35 mm) and cut-to-length, height-adjustable protective tubes 	16
	Uponor Uni-X screw connection MLC		
	2 units	 <ul style="list-style-type: none"> • Two-part screw connection made of brass, with tin-plated union nut and pressure sleeve • For the direct connection of Uponor composite pipes, Uni Pipe PLUS and MLC, to ¾ MT moulded euro-cone parts as well as manifold H • Internal thread according to DIN EN ISO 228-1 • Connect without deburring 	14-¾"FT Euro 16-¾"FT Euro 20-¾"FT Euro

Two-pipe heating with loop line, radiator connections from below

Valve radiator with Uponor S-Press PLUS radiator connection T-adapter

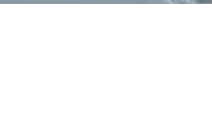

Variant 1

	Number	Designation	Dimension
	Uponor S-Press PLUS radiator T-adapter		
	2 units	 <ul style="list-style-type: none"> • Made of brass and offset coated copper tube • The 15 mm copper pipe can be connected to the radiator using the Uponor Smart radi Cu compression adapter. 	16-15CU-16 l=350 mm 20-15CU-20 l=350 mm
	Uponor Smart radi compression adapter Cu		
	2 units	 <ul style="list-style-type: none"> • With G¾ euro-cone elastically sealing for the connection of coated copper pipes 15 x 1 mm of Uponor elbow adapters/T-joints to a tap block, radiator or Uponor radiator connecting nipple with G¾ MT euro-cone • Union nut brass coated, clamping ring brass bright and EPDM sealing cone • Ribbed union nut with wrench size 30 	15CU-¾" Euro

Variant 2, like variant 1, but additionally

Number	Designation	Dimension
Uponor Smart radi connecting nipple		
2 units	 <ul style="list-style-type: none"> • Brass coated • Self-sealing • For connecting radiators with ½ IG connections, ¾ MT euro-cone for connecting Cu pipe 15 x 1 mm with Uponor compression adapter Cu with ¾ euro-cone 	G¾"MT- G½"MT

Valve radiator with the Uponor Smart radi connection block from the wall



Number	Designation	Dimension
Uponor Smart radi connection block		
1 unit	 <ul style="list-style-type: none"> • Made of polystyrene with removable protective cap • Insulation box in fire class E according to DIN EN 13501-1 • Suitable for all common valve radiators 	16 h = 215 mm 16 h = 240 mm
Uponor S-Press PLUS radiator cross fitting insulated with insulation box		
1 unit	 <ul style="list-style-type: none"> • Made of tin-plated brass • For crossing-free, pre-insulated connection of a radiator on the unfinished floor • Including EPP insulation box, two-part 13 mm insulation, thermal conductivity 0.035 W/(m*K). Meets EnEV requirements in the area of pipe crossings and feed-throughs! • Dimensions of the insulation box (L x W x H): 115 x 115 x 55 mm 	16-16-16 20-16-16 20-16-20 20-20-20
Uponor Uni-X screw connection MLC		
2 units	 <ul style="list-style-type: none"> • Two-part screw connection made of brass, with tin-plated union nut and pressure sleeve • For the direct connection of Uponor composite pipes, Uni Pipe PLUS and MLC, to ¾ MT moulded euro-cone parts as well as manifold H • Internal thread according to DIN EN ISO 228-1 • Connect without deburring 	16-¾"FT Euro

Connection of a valve radiator with the Uponor Smart radi connection block from the wall. Connection to the distribution line with the Uponor S-Press PLUS radiator cross fitting with insulation box

Two-pipe heating from the baseboard, radiator connections from below



Valve radiator with Uponor S-Press PLUS baseboard connection kit, adapter and Uponor Smart angle baseboard

Number	Designation	Dimension
Uponor S-Press PLUS connection kit adapter		
1 pair	 <ul style="list-style-type: none"> • For the installation of baseboards without chiselling out the wall. For connection of Uponor composite pipes MLC/Uni Pipe PLUS to radiators with valves • Thread according to DIN EN ISO 228-1 	16-G½" MT-16 16-G½" MT-20 16-G½" MT-0 20-G½" MT-16 0-G½" MT-16 20-G½" MT-20
Uponor Smart Base angle baseboard		

Number	Designation	Dimension
1 pair	 <ul style="list-style-type: none"> For connection to the radiator during base installation, in conjunction with the Uponor S-Press PLUS baseboard connection kit. The coated copper pipe, 15 x 1 mm, can be connected to the radiator using the Uponor Cu compression adapter. 	15 x 1
Uponor Smart radi compression adapter Cu		
2 units	 <ul style="list-style-type: none"> With G$\frac{3}{4}$ euro-cone elastically sealing for the connection of coated copper pipes 15 x 1 mm of Uponor elbow adapters/T-joints to a tap block, radiator or Uponor radiator connecting nipple with G$\frac{3}{4}$ MT euro-cone Union nut brass coated, clamping ring brass bright and EPDM sealing cone Ribbed union nut with wrench size 30 	15CU- $\frac{3}{4}$ " Euro

Single-pipe heating with loop line, radiator connections from below

Radiator and single-pipe valve fitting using Uponor Uni screw MLC connection from the floor

Number	Designation	Dimension
Option 1		
Uponor Uni-C screw connection MLC		
2 units	 <ul style="list-style-type: none"> Two-part brass screw connection, with union nut and pressure sleeve For the connection of Uponor composite pipes MLC/Uni Pipe PLUS to MT- Uponor fittings, sanitary connections and Uni-C manifolds S Internal thread according to DIN EN ISO 228-1 Connect without deburring 	14- $\frac{1}{2}$ "FT Euro 16- $\frac{1}{2}$ "FT Euro 20- $\frac{1}{2}$ "FT Euro
Option 2		
Uponor Uni-C screw connection MLC		
2 units	 <ul style="list-style-type: none"> Two-part brass screw connection, with union nut and pressure sleeve For the connection of Uponor composite pipes MLC/Uni Pipe PLUS to MT- Uponor fittings, sanitary connections and Uni-C manifolds S Internal thread according to DIN EN ISO 228-1 Connect without deburring 	14- $\frac{3}{4}$ "FT Euro 16- $\frac{3}{4}$ "FT Euro 20- $\frac{3}{4}$ "FT Euro 25- $\frac{3}{4}$ "FT Euro

Valve radiator and single-pipe connection block using the Uponor S-Press PLUS radiator connection elbow out of the floor

Number	Designation	Dimension
Uponor S-Press PLUS radiator connection elbow		
2 units	 <ul style="list-style-type: none"> Made of brass and coated copper tube The 15 mm copper pipe can be connected to the radiator using the Uponor Smart radi Cu compression adapter. 	14-15CU l=350 mm 16-15CU l=350 mm 16-15CU l=1000 mm

Number	Designation	Dimension
Uponor Smart radi compression adapter Cu		
2 units	 <ul style="list-style-type: none"> With G$\frac{3}{4}$ euro-cone elastically sealing for the connection of coated copper pipes 15 x 1 mm of Uponor elbow adapters/T-joints to a tap block, radiator or Uponor radiator connecting nipple with G$\frac{3}{4}$ MT euro-cone Union nut brass coated, clamping ring brass bright and EPDM sealing cone Ribbed union nut with wrench size 30 	15CU- $\frac{3}{4}$ " Euro

11.5 Data for pipe network calculations

Pipe friction pressure gradient for Uponor composite pipes 14 — 40 mm

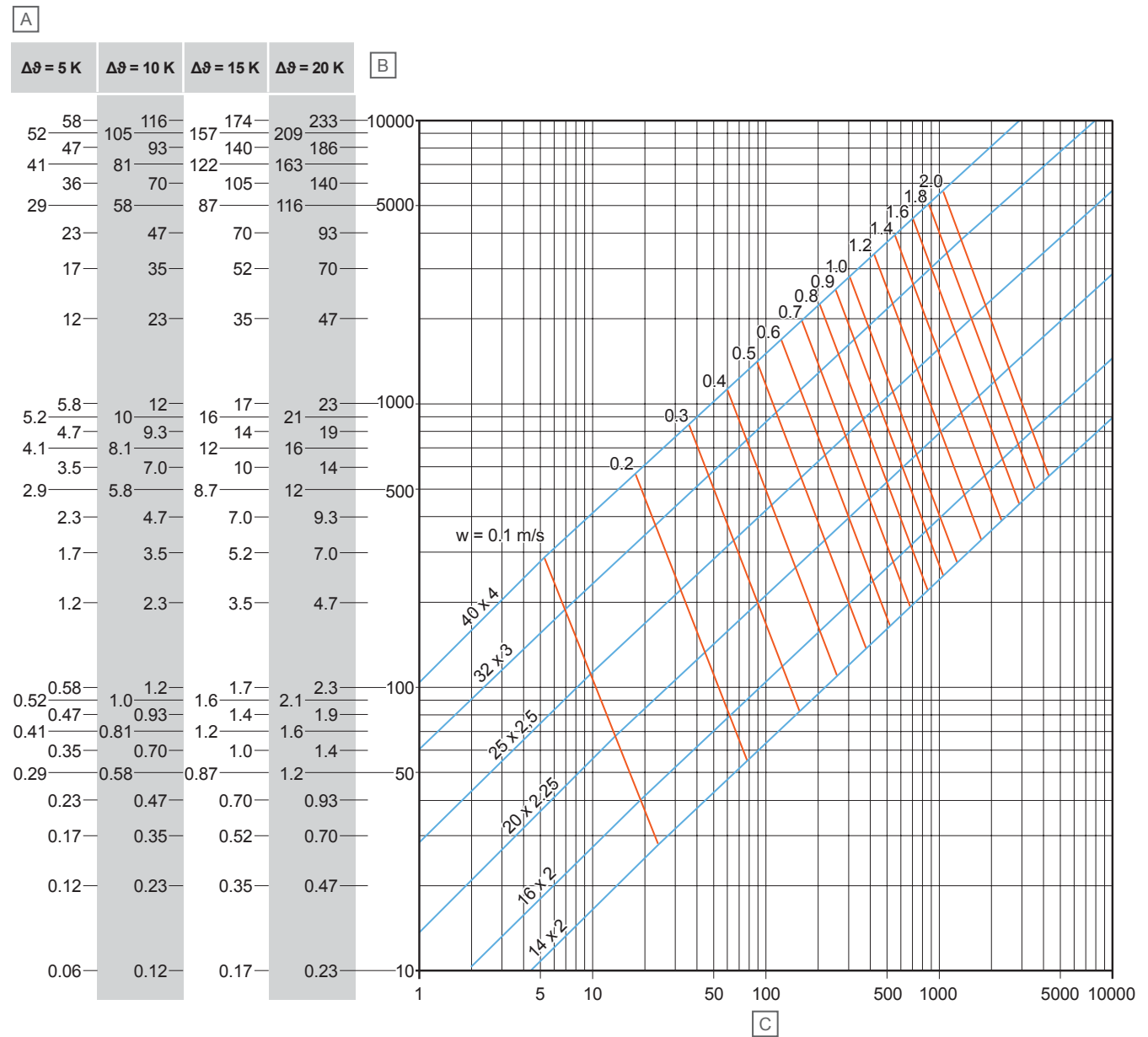

Item	Description
A	Power Q kW
B	Mass flow m kg/h
C	Pipe friction pressure gradient R PA/m

Pipe friction pressure gradient for Uponor composite pipes 14 — 40 mm in heating installations as a function of mass flow at an average water temperature of 60 °C

Pipe friction pressure gradient for Uponor composite pipes 50 — 110 mm

A

	$\Delta\theta = 5\text{ K}$	$\Delta\theta = 10\text{ K}$	$\Delta\theta = 15\text{ K}$	$\Delta\theta = 20\text{ K}$	B
	581	1163	1744	2325	100000
523	1046	930	1569	2093	1860
407	814	1221	1395	1628	1395
349	698	1046	1046	1395	930
291	581	872	1163	1163	698
233	465	698	930	930	465
174	349	523	698	698	349
116	233	349	465	465	233
58	116	174	233	233	116
52	105	93	140	209	186
41	81	122	163	163	140
35	70	105	140	140	105
29	58	87	116	116	87
23	47	70	93	93	70
17	35	52	70	70	52
12	23	35	47	47	35
5.8	12	17	23	23	17
5.2	10	14	21	21	14
4.7	9.3	12	16	16	12
4.1	8.1	10	14	14	10
3.5	7.0	10	14	14	10
2.9	5.8	8.7	12	12	8.7
2.3	4.7	7.0	9.3	9.3	7.0
1.7	3.5	5.2	7.0	7.0	5.2
1.2	2.3	3.5	4.7	4.7	3.5
0.6	1.2	1.7	2.3	2.3	1.7

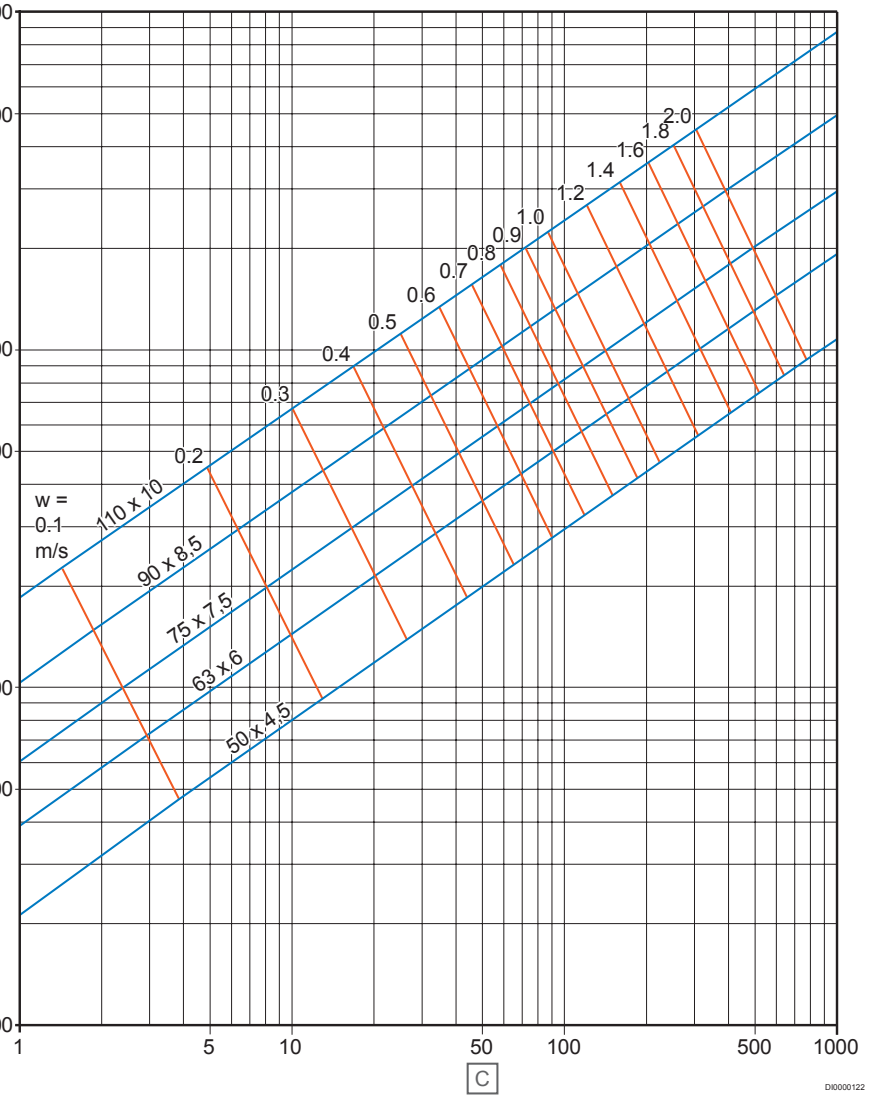

Item	Description
A	Power Q kW
B	Mass flow m kg/h
C	Pipe friction pressure gradient R PA/m

Pipe friction pressure gradient for Uponor composite pipes 50 — 110 mm in heating installations as a function of mass flow at an average water temperature of 60 °C

Pipe friction tables for heating/cooling

Tables describing the pipe friction pressure gradient (heating or cooling mode) for water as a function of heat or mass flow are

available in the following pages. Parameters for the respective tables are given in the headlines.

For cooling mode, possible condensation must be taken into account. If necessary, suitable measures must be taken for condensate drainage.

Insufficiently insulated cold water pipes can lead to condensation on the surface of the insulation layer, and unsuitable materials can become damp. Closed cell or comparable materials with a high water vapour diffusion resistance should be used. All joints, cuts, seams and ends must be sealed water vapour-tight.

Heating mode: $\Delta\theta = 20\text{ K}$ (80 °C/60 °C) - 14 — 16 mm

OD x s (ID) — V/l		14 x 2 mm (10 mm) — 0.08 l/m		16 x 2 mm (12 mm) — 0.11 l/m	
Q, W	m, kg/h	v, m/s	R, Pa/m	v, m/s	R, Pa/m
400	17	0.06	10	0.04	4
600	26	0.09	20	0.06	9
800	34	0.12	33	0.09	14
1000	43	0.16	48	0.11	21
1200	52	0.19	66	0.13	28
1400	60	0.22	86	0.15	26
1600	69	0.25	108	0.17	26
1800	78	0.28	132	0.19	56
2000	86	0.31	159	0.22	67
2200	95	0.34	187	0.24	79
2400	103	0.37	218	0.26	92
2600	112	0.41	250	0.28	105
2800	121	0.44	284	0.30	120
3000	129	0.47	321	0.32	135
3200	138	0.50	359	0.35	151
3400	146	0.53	399	0.37	168
3600	155	0.56	441	0.39	186
3800	164	0.59	484	0.41	204
4000	172	0.62	530	0.43	223
4200	181	0.65	577	0.45	243
4400	189	0.69	626	0.48	263
4600	198	0.72	677	0.50	284
4800	207	0.75	729	0.52	306
5000	215	0.78	783	0.54	329
5200	224	0.81	839	0.56	353
5400	233	0.84	897	0.58	377
5600	241	0.87	956	0.61	401
5800	250	0.90	1017	0.63	427
6000	258	0.93	1079	0.65	453
6200	267	0.97	1143	0.67	480
6400	276	1.00	1209	0.69	507
6600	284			0.71	536
6800	293			0.74	564
7000	301			0.76	594
7200	310			0.78	624
7400	319			0.80	655
7600	327			0.82	687
7800	336			0.84	719
8000	344			0.87	751
8500	366			0.92	836
9000	388			0.97	925
9500	409			1.03	1018
10000	431				
10500	452				
11000	474				
11500	495				
12000	517				
12500	538				
13000	560				
13500	581				

Q = Power in Watt, v = Flow velocity in metres/second

R = Pipe friction pressure gradient in Pascal/Meter (100 Pa = 1 hPa = 1 mbar, 1 hPa ~ 10 mm WS)

Heating mode: $\Delta\theta = 20 \text{ K}$ (80 °C/60 °C) - 20 — 32 mm

OD x s (ID) — V/l		20 x 2,25 mm (15,5 mm)— 0.19 l/m		25 x 2,5 mm (20 mm) — 0.31 l/m		32 x 2 mm (26 mm) — 0.53 l/m	
Q, W	m, kg/h	v, m/s	R, Pa/m	v, m/s	R, Pa/m	v, m/s	R, Pa/m
1000	43	0.06	6	0.04	2	0.02	1
2000	86	0.13	20	0.08	6	0.05	2
3000	129	0.19	66	0.12	12	0.07	4
4000	172	0.026	98	0.16	20	0.09	6
5000	215	0.32	134	0.19	29	0.12	8
6000	258	0.45	176	0.23	40	0.14	12
7000	301	0.52	222	0.27	52	0.16	15
8000	344	0.58	273	0.31	66	0.18	19
9000	388	0.65	329	0.35	81	0.21	23
10000	431	0.71	389	0.39	98	0.23	28
11000	474	0.78	454	0.43	116	0.25	33
12000	517	0.84	523	0.47	135	0.28	39
13000	560	0.91	596	0.51	155	0.30	44
14000	603	0.97	673	0.55	177	0.32	51
15000	646	1.04	755	0.58	200	0.35	57
16000	689			0.62	224	0.37	64
17000	732			0.66	249	0.39	71
18000	775			0.70	275	0.41	79
19000	818			0.74	303	0.44	87
20000	861			0.78	332	0.46	95
21000	904			0.82	362	0.48	103
22000	947			0.86	393	0.51	112
23000	990			0.90	425	0.53	122
24000	1033			0.93	459	0.55	131
25000	1077			0.97	493	0.58	141
26000	1120			1.01	529	0.60	151
27000	1163			1.05	566	0.62	161
28000	1206			1.09	603	0.65	172
29000	1249			1.13	642	0.67	183
30000	1292			1.17	682	0.69	195
32000	1378			1.25	766	0.74	218
34000	1464			1.32	853	0.78	243
36000	1550			1.40	945	0.83	269
38000	1636			1.48	1041	0.88	296
40000	1722			1.56	1140	0.92	325
42000	1809					0.97	354
44000	1895					1.01	385
46000	1981					1.06	417
48000	2067					1.11	449
50000	2153					1.15	483
52000	2239					1.20	519
54000	2325					1.24	555
56000	2411					1.29	592
58000	2498					1.34	630
60000	2584					1.38	670
62000	2670					1.43	710
64000	2756					1.48	752
66000	2842					1.52	795
68000	2928					1.57	838
70000	3014					1.61	883

Q = Power in Watt, v = Flow velocity in metres/second

R = Pipe friction pressure gradient in Pascal/Meter (100 Pa = 1 hPa = 1 mbar, 1 hPa ~ 10 mm WS)

Heating mode: $\Delta\theta = 20\text{ K}$ (80 °C/60 °C) - 40 — 63 mm

OD x s (ID) — V/l		40 x 4 mm (32 mm) — 0.80 l/m		50 x 4,5 mm (41 mm) — 1.32 l/m		63 x 6 mm (51 mm) — 2.04 l/m	
Q, W	m, kg/h	v, m/s	R, Pa/m	v, m/s	R, Pa/m	v, m/s	R, Pa/m
5000	215	0.08	3	0.05	1	0.03	1
10000	431	0.15	10	0.09	3	0.06	1
15000	646	0.23	21	0.14	7	0.09	2
20000	861	0.30	35	0.19	11	0.12	4
25000	1077	0.38	52	0.23	16	0.15	6
30000	1292	0.46	72	0.28	22	0.18	8
35000	1507	0.53	95	0.32	29	0.21	10
40000	1722	0.61	120	0.37	37	0.24	13
45000	1938	0.68	148	0.42	45	0.27	16
50000	2153	0.76	179	0.46	55	0.30	19
55000	2368	0.84	212	0.51	65	0.33	23
60000	2584	0.91	248	0.56	76	0.36	27
65000	2799	0.99	286	0.60	87	0.39	31
70000	3014	1.07	326	0.65	100	0.42	35
75000	3230	1.14	369	0.70	113	0.45	40
80000	3445	1.22	414	0.74	126	0.48	44
85000	3660	1.29	462	0.79	141	0.51	50
90000	3876	1.37	512	0.83	156	0.54	55
95000	4091	1.45	564	0.88	172	0.57	60
100000	4306	1.52	619	0.93	188	0.60	66
105000	4522			0.97	206	0.63	72
110000	4737			1.02	223	0.66	78
115000	4952			1.07	242	0.69	85
120000	5167			1.11	261	0.72	92
125000	5383			1.16	281	0.75	99
130000	5598			1.20	302	0.78	106
135000	5813			1.25	323	0.81	113
140000	6029			1.30	345	0.84	121
145000	6244			1.34	367	0.87	129
150000	6459			1.39	390	0.90	137
160000	6890			1.48	438	0.96	154
170000	7321			1.58	489	1.02	171
180000	7751					1.08	190
190000	8182					1.14	209
200000	8612					1.20	230
210000	9043					1.26	251
220000	9474					1.32	273
230000	9904					1.38	295
240000	10335					1.44	319
250000	10766					1.50	343
260000	11196					1.56	368
270000	11627					1.62	394
280000	12057					1.68	421
290000	12488					1.74	449
300000	12919					1.80	477
310000	13349					1.86	506
320000	13780					1.92	536
330000	14211					1.98	567
340000	14641					2.04	599
350000	15072					2.10	630

Q = Power in Watt, v = Flow velocity in metres/second

R = Pipe friction pressure gradient in Pascal/Meter (100 Pa = 1 hPa = 1 mbar, 1 hPa ~ 10 mm WS)

Heating mode: $\Delta\theta = 20\text{ K}$ (80 °C/60 °C) - 75 — 110 mm

OD x s (ID) — V/I		75 x 7,5 mm (60 mm) — 2.83 l/m		90 x 8,5 mm (73 mm) — 4.18 l/m		110 x 10 mm (90 mm) — 6.36 l/m	
Q, W	m, kg/h	v, m/s	R, Pa/m	v, m/s	R, Pa/m	v, m/s	R, Pa/m
60000	2584	0.26	12	0.18	5	0.12	2
80000	3445	0.35	20	0.23	8	0.15	3
100000	4306	0.43	30	0.29	12	0.19	4
120000	5167	0.52	42	0.35	16	0.23	6
140000	6029	0.61	55	0.41	22	0.27	8
160000	6890	0.69	70	0.47	28	0.31	10
180000	7751	0.78	87	0.53	34	0.35	12
200000	8612	0.87	105	0.58	41	0.38	15
220000	9474	0.95	125	0.64	49	0.42	18
240000	10335	1.04	146	0.70	57	0.46	21
260000	11196	1.13	169	0.76	66	0.50	24
280000	12057	1.21	193	0.82	75	0.54	28
300000	12919	1.30	218	0.88	85	0.58	31
320000	13780	1.38	245	0.94	96	0.62	35
340000	14641	1.47	274	0.99	107	0.65	39
360000	15502	1.56	304	1.05	118	0.69	43
380000	16364	1.64	335	1.11	130	0.73	48
400000	17225	1.73	367	1.17	143	0.77	52
420000	18086	1.82	401	1.23	156	0.81	57
440000	18947	1.90	437	1.29	170	0.85	62
460000	19809	1.99	473	1.34	184	0.88	67
480000	20670			1.40	199	0.92	73
500000	21531			1.46	214	0.96	78
520000	22392			1.52	230	1.00	84
540000	23254			1.58	246	1.04	90
560000	24115			1.64	263	1.08	96
580000	24976			1.70	280	1.12	102
600000	25837			1.75	298	1.15	109
620000	26699			1.81	316	1.19	115
640000	27560			1.87	335	1.23	122
660000	28421			1.93	354	1.27	129
680000	29282			1.99	374	1.31	136
700000	30144					1.35	144
720000	31005					1.38	151
740000	31866					1.42	159
760000	32727					1.46	167
780000	33589					1.50	175
800000	34450					1.54	183
820000	35311					1.58	192
840000	36172					1.62	200
860000	37033					1.65	209
880000	37895					1.69	218
900000	38756					1.73	227
920000	39617					1.77	236
940000	40478					1.81	245
960000	41340					1.85	255
980000	42201					1.89	265
1000000	43062					1.92	275
1020000	43923					1.96	285
1040000	44785					2.00	295

Q = Power in Watt, v = Flow velocity in metres/second

R = Pipe friction pressure gradient in Pascal/Meter (100 Pa = 1 hPa = 1 mbar, 1 hPa ~ 10 mm WS)

Heating mode: $\Delta\theta = 20\text{ K}$ (70 °C/50 °C) - 14 — 16 mm

OD x s (ID) — V/I		14 x 2 mm (10 mm) — 0.08 l/m		16 x 2 mm (12 mm) — 0.11 l/m	
Q, W	m, kg/h	v, m/s	R, Pa/m	v, m/s	R, Pa/m
200	9	0.03	3	0.02	1
400	17	0.06	11	0.04	5
600	26	0.09	21	0.06	9
800	34	0.12	34	0.09	15
1000	43	0.15	50	0.11	21
1200	52	0.19	68	0.13	29
1400	60	0.22	89	0.15	38
1600	69	0.25	112	0.17	47
1800	78	0.28	137	0.19	58
2000	86	0.31	114	0.22	69
2200	95	0.34	194	0.24	82
2400	103	0.37	225	0.26	95
2600	112	0.40	258	0.28	109
2800	121	0.43	294	0.30	124
3000	129	0.46	331	0.32	140
3200	138	0.50	370	0.34	156
3400	146	0.53	411	0.37	173
3600	155	0.56	454	0.39	192
3800	164	0.59	499	0.41	210
4000	172	0.62	546	0.43	230
4200	181	0.65	595	0.45	250
4400	189	0.68	645	0.47	271
4600	198	0.71	697	0.50	293
4800	207	0.74	751	0.52	316
5000	215	0.77	807	0.54	339
5200	224	0.81	864	0.56	363
5400	233	0.84	923	0.58	388
5600	241	0.87	984	0.60	414
5800	250	0.90	1046	0.62	440
6000	258	0.93	1111	0.65	467
6200	267	0.96	1177	0.67	494
6400	276	0.99	1244	0.69	522
6600	284	1.02	1313	0.71	551
6800	293			0.73	581
7000	301			0.75	611
7500	323			0.81	690
8000	344			0.86	773
8500	366			0.91	860
9000	388			0.97	951
9500	409			1.02	1046
10000	431				
10500	452				
11000	474				
11500	495				
12000	517				
12500	538				
13000	560				
13500	581				
14000	603				
14500	624				

Q = Power in Watt, v = Flow velocity in metres/second

R = Pipe friction pressure gradient in Pascal/Meter (100 Pa = 1 hPa = 1 mbar, 1 hPa ~ 10 mm WS)

Heating mode: $\Delta\theta = 20\text{ K}$ (70 °C/50 °C) - 20 — 32 mm

OD x s (ID) — V/l		20 x 2,25 mm (15,5 mm) — 0.19 l/m		25 x 2,5 mm (20 mm) — 0.31 l/m		32 x 2 mm (26 mm) — 0.53 l/m	
Q, W	m, kg/h	v, m/s	R, Pa/m	v, m/s	R, Pa/m	v, m/s	R, Pa/m
1000	43	0.06	6	0.04	2	0.02	1
2000	86	0.13	21	0.08	6	0.05	2
3000	129	0.19	42	0.12	13	0.07	4
4000	172	0.26	68	0.15	21	0.09	6
5000	215	0.32	101	0.19	30	0.11	9
6000	258	0.39	138	0.23	41	0.14	12
7000	301	0.45	181	0.27	54	0.16	16
8000	344	0.52	229	0.31	68	0.18	20
9000	388	0.58	281	0.35	84	0.21	24
10000	431	0.64	338	0.39	101	0.23	29
11000	474	0.71	400	0.43	119	0.25	34
12000	517	0.77	466	0.46	139	0.28	40
13000	560	0.84	537	0.50	160	0.30	46
14000	603	0.90	612	0.54	182	0.32	52
15000	646	0.97	692	0.58	205	0.34	59
16000	689	1.03	755	0.62	230	0.37	66
17000	732			0.66	256	0.39	73
18000	775			0.70	283	0.41	81
19000	818			0.74	311	0.44	89
20000	861			0.77	341	0.46	98
21000	904			0.81	372	0.48	106
22000	947			0.85	404	0.50	115
23000	990			0.89	437	0.53	125
24000	1033			0.93	471	0.55	135
25000	1077			0.97	506	0.57	145
26000	1120			1.01	543	0.60	155
27000	1163			1.05	580	0.62	166
28000	1206			1.08	619	0.64	177
29000	1249			1.12	659	0.66	185
30000	1292			1.16	700	0.69	200
32000	1378			1.24	785	0.73	224
34000	1464			1.32	875	0.78	249
36000	1550			1.39	969	0.83	276
38000	1636			1.47	1067	0.87	304
40000	1722			1.55	1169	0.92	333
42000	1809					0.96	363
44000	1895					1.01	395
46000	1981					1.05	427
48000	2067					1.10	461
50000	2153					1.15	496
52000	2239					1.19	532
54000	2325					1.24	569
56000	2411					1.28	607
58000	2498					1.33	646
60000	2584					1.38	686
62000	2670					1.42	728
64000	2756					1.47	770
66000	2842					1.51	814
68000	2928					1.56	859
70000	3014					1.60	905

Q = Power in Watt, v = Flow velocity in metres/second

R = Pipe friction pressure gradient in Pascal/Meter (100 Pa = 1 hPa = 1 mbar, 1 hPa ~ 10 mm WS)

Heating mode: $\Delta\theta = 20\text{ K}$ (70 °C/50 °C) - 40 — 63 mm

OD x s (ID) — V/I		40 x 4 mm (32 mm) — 0.80 l/m		50 x 4,5 mm (41 mm) — 1.32 l/m		63 x 6 mm (51 mm) — 2.04 l/m	
Q, W	m, kg/h	v, m/s	R, Pa/m	v, m/s	R, Pa/m	v, m/s	R, Pa/m
10000	431	0.15	11	0.09	3	0.06	1
15000	646	0.23	22	0.14	7	0.09	2
20000	861	0.30	36	0.18	11	0.12	4
25000	1077	0.38	54	0.23	17	0.15	6
30000	1292	0.45	74	0.28	23	0.18	8
35000	1507	0.53	97	0.32	30	0.21	11
40000	1722	0.61	123	0.37	38	0.24	13
45000	1938	0.68	152	0.41	47	0.27	16
50000	2153	0.76	184	0.46	56	0.30	20
55000	2368	0.83	217	0.51	67	0.33	23
60000	2584	0.91	254	0.55	78	0.36	27
65000	2799	0.98	293	0.60	89	0.39	32
70000	3014	1.06	334	0.65	102	0.42	36
75000	3230	1.13	378	0.69	115	0.45	41
80000	3445	1.21	425	0.74	130	0.48	46
85000	3660	1.29	473	0.78	144	0.51	51
90000	3876	1.36	524	0.83	160	0.54	56
95000	4091	1.44	578	0.88	176	0.57	62
100000	4306	1.51	633	0.92	193	0.60	68
105000	4522			0.97	211	0.63	74
110000	4737			1.01	229	0.66	80
115000	4952			1.06	248	0.69	87
120000	5167			1.11	267	0.71	94
125000	5383			1.15	288	0.74	101
130000	5598			1.20	309	0.77	108
135000	5813			1.24	330	0.80	116
140000	6029			1.29	353	0.83	124
145000	6244			1.34	376	0.86	132
150000	6459			1.38	399	0.89	140
160000	6890			1.47	448	0.95	157
170000	7321			1.57	500	1.01	175
180000	7751					1.07	194
190000	8182					1.13	214
200000	8612					1.19	235
210000	9043					1.25	256
220000	9474					1.31	279
230000	9904					1.37	302
240000	10335					1.43	326
250000	10766					1.49	351
260000	11196					1.55	377
270000	11627					1.61	403
280000	12057					1.67	431
290000	12488					1.73	459
300000	12919					1.79	488
310000	13349					1.85	518
320000	13780					1.91	548
330000	14211					1.97	579
340000	14641					2.03	612
350000	15072					2.09	644
360000	15502					2.14	678

Q = Power in Watt, v = Flow velocity in metres/second

R = Pipe friction pressure gradient in Pascal/Meter (100 Pa = 1 hPa = 1 mbar, 1 hPa ~ 10 mm WS)

Heating mode: $\Delta\theta = 20\text{ K}$ (70 °C/50 °C) - 75 — 110 mm

OD x s (ID) — V/I		75 x 7,5 mm (60 mm) — 2.83 l/m		90 x 8,5 mm (73 mm) — 4.18 l/m		110 x 10 mm (90 mm) — 6.36 l/m	
Q, W	m, kg/h	v, m/s	R, Pa/m	v, m/s	R, Pa/m	v, m/s	R, Pa/m
70000	3014	0.30	17	0.20	6	0.13	2
90000	3876	0.39	26	0.26	10	0.17	4
110000	4737	0.47	37	0.32	14	0.21	5
130000	5598	0.56	50	0.38	19	0.25	7
150000	6459	0.65	64	0.44	25	0.29	9
170000	7321	0.73	80	0.49	31	0.33	12
190000	8182	0.82	98	0.55	38	0.36	14
210000	9043	0.90	118	0.61	46	0.40	17
230000	9904	0.99	138	0.67	54	0.44	20
250000	10766	1.08	161	0.73	63	0.48	23
270000	11627	1.16	185	0.79	72	0.52	26
290000	12488	1.25	210	0.84	82	0.55	30
310000	13349	1.33	237	0.90	92	0.59	34
330000	14211	1.42	265	0.96	103	0.63	38
350000	15072	1.51	295	1.02	115	0.67	42
370000	15933	1.59	326	1.08	127	0.71	46
390000	16794	1.68	359	1.13	140	0.75	51
410000	17656	1.76	392	1.19	153	0.78	56
430000	18517	1.85	428	1.25	167	0.82	61
450000	19378	1.94	464	1.31	181	0.86	66
470000	20239	2.02	503	1.37	196	0.90	71
490000	21100			1.42	211	0.94	77
510000	21962			1.48	227	0.98	83
530000	22823			1.54	243	1.01	89
550000	23254			1.60	260	1.05	95
570000	24545			1.66	277	1.09	101
590000	25407			1.72	295	1.13	108
610000	26268			1.77	313	1.17	114
630000	27129			1.83	332	1.21	121
650000	27990			1.89	352	1.24	128
670000	28852			1.95	372	1.28	136
690000	29713			2.01	392	1.32	143
710000	30574					1.36	151
730000	31435					1.40	158
750000	32297					1.43	166
770000	33158					1.47	174
790000	34019					1.51	183
810000	34880					1.55	191
830000	35742					1.59	200
850000	36603					1.63	209
870000	37464					1.66	218
890000	38325					1.70	227
910000	39187					1.74	236
930000	40048					1.78	246
950000	40909					1.82	255
970000	41770					1.86	265
990000	42632					1.89	275
1010000	43493					1.93	285
1030000	44354					1.97	296
1050000	45215					2.01	306

Q = Power in Watt, v = Flow velocity in metres/second

R = Pipe friction pressure gradient in Pascal/Meter (100 Pa = 1 hPa = 1 mbar, 1 hPa ~ 10 mm WS)

Heating mode: $\Delta\theta = 15\text{ K}$ (70 °C/55 °C) - 14 — 16 mm

OD x s (ID) — V/l		14 x 2 mm (10 mm) — 0.08 l/m		16 x 2 mm (12 mm) — 0.11 l/m	
Q, W	m, kg/h	v, m/s	R, Pa/m	v, m/s	R, Pa/m
200	11	0.04	5	0.03	2
400	23	0.08	17	0.06	7
600	34	0.12	34	0.09	14
800	46	0.17	55	0.11	24
1000	57	0.21	81	0.14	34
1200	69	0.25	111	0.17	47
1400	80	0.29	145	0.20	61
1600	92	0.33	182	0.23	77
1800	103	0.37	223	0.26	94
2000	115	0.41	268	0.29	113
2200	126	0.46	316	0.32	133
2400	138	0.50	367	0.34	155
2600	149	0.54	422	0.37	178
2800	161	0.58	480	0.40	202
3000	172	0.62	542	0.43	228
3200	184	0.66	606	0.46	255
3400	195	0.70	674	0.49	284
3600	207	0.74	745	0.52	313
3800	218	0.79	819	0.55	344
4000	230	0.83	896	0.57	377
4200	241	0.87	976	0.60	410
4400	253	0.91	1060	0.63	445
4600	264	0.95	1146	0.66	481
4800	276	0.99	1235	0.69	518
5000	287	1.03	1327	0.72	557
5200	299			0.75	597
5400	310			0.78	638
5600	322			0.80	680
5800	333			0.83	723
6000	344			0.86	767
6200	356			0.89	813
6400	367			0.92	860
6600	379			0.95	908
6800	390			0.98	957
7000	402			1.01	1007
7200	413				
7400	425				
7600	436				
7800	448				
8000	459				
8200	471				
8400	482				
8600	494				
8800	505				
9000	517				
9200	528				
9400	540				
9600	551				
9800	563				
10000	574				

Q = Power in Watt, v = Flow velocity in metres/second

R = Pipe friction pressure gradient in Pascal/Meter (100 Pa = 1 hPa = 1 mbar, 1 hPa ~ 10 mm WS)

Heating mode: $\Delta\theta = 15\text{ K}$ (70 °C/55 °C) - 20 — 32 mm

OD x s (ID) — V/l		20 x 2,25 mm (15,5 mm) — 0.19 l/m		25 x 2,5 mm (20 mm) — 0.31 l/m		32 x 2 mm (26 mm) — 0.53 l/m	
Q, W	m, kg/h	v, m/s	R, Pa/m	v, m/s	R, Pa/m	v, m/s	R, Pa/m
1000	57	0.09	10	0.05	3	0.03	1
1500	86	0.13	21	0.08	6	0.05	2
2000	115	0.17	34	0.10	10	0.06	3
2500	144	0.22	50	0.13	15	0.08	4
3000	172	0.26	68	0.16	20	0.09	6
3500	201	0.30	89	0.18	27	0.11	8
4000	230	0.34	112	0.21	33	0.12	10
4500	258	0.39	137	0.23	41	0.14	12
5000	287	0.43	165	0.26	49	0.15	14
5500	316	0.47	195	0.28	58	0.17	17
6000	344	0.52	227	0.31	68	0.18	19
6500	373	0.56	261	0.34	78	0.20	22
7000	402	0.60	298	0.36	89	0.21	25
7500	431	0.65	336	0.39	100	0.23	29
8000	459	0.69	376	0.41	112	0.24	32
8500	488	0.73	419	0.44	124	0.26	36
9000	517	0.78	463	0.47	138	0.28	40
9500	545	0.82	509	0.49	151	0.29	43
10000	574	0.86	558	0.52	166	0.31	48
10500	603	0.90	608	0.54	180	0.32	52
11000	632	0.95	660	0.57	196	0.34	56
11500	660	0.99	714	0.59	212	0.35	61
12000	689	1.03	770	0.62	228	0.37	65
12500	718			0.65	245	0.38	70
13000	746			0.67	263	0.40	75
13500	775			0.70	281	0.41	80
14000	804			0.72	300	0.43	86
14500	833			0.75	319	0.44	91
15000	861			0.78	339	0.46	97
16000	919			0.83	380	0.49	109
17000	976			0.88	423	0.52	121
18000	1033			0.93	468	0.55	134
19000	1091			0.98	515	0.58	147
20000	1148			1.03	564	0.61	161
22000	1263			1.14	668	0.67	191
24000	1378			1.24	780	0.73	222
26000	1493			1.34	900	0.80	256
28000	1608			1.45	1027	0.86	293
30000	1722			1.55	1161	0.92	331
32000	1837					0.98	371
34000	1952					1.04	413
36000	2067					1.10	458
38000	2182					1.16	504
40000	2297					1.22	552
42000	2411					1.29	603
44000	2526					1.35	655
46000	2641					1.41	709
48000	2756					1.47	766
50000	2871					1.53	824
52000	2986					1.59	884

Q = Power in Watt, v = Flow velocity in metres/second

R = Pipe friction pressure gradient in Pascal/Meter (100 Pa = 1 hPa = 1 mbar, 1 hPa ~ 10 mm WS)

Heating mode: $\Delta\theta = 15\text{ K}$ (70 °C/55 °C) - 40 — 63 mm

OD x s (ID) — V/I		40 x 4 mm (32 mm) — 0.80 l/m		50 x 4,5 mm (41 mm) — 1.32 l/m		63 x 6 mm (51 mm) — 2.04 l/m	
Q, W	m, kg/h	v, m/s	R, Pa/m	v, m/s	R, Pa/m	v, m/s	R, Pa/m
8000	459	0.16	12	0.10	4	0.06	1
10000	574	0.20	18	0.12	5	0.08	2
12000	689	0.24	24	0.15	8	0.10	3
14000	804	0.28	32	0.17	10	0.11	3
16000	919	0.32	40	0.20	12	0.13	4
18000	1033	0.36	50	0.22	15	0.14	5
20000	1148	0.40	60	0.25	18	0.16	7
22000	1263	0.44	71	0.27	22	0.17	8
24000	1378	0.48	83	0.30	25	0.19	9
26000	1493	0.53	95	0.32	29	0.21	10
28000	1608	0.57	108	0.34	33	0.22	12
30000	1722	0.61	123	0.37	38	0.24	13
32000	1837	0.65	137	0.39	42	0.25	15
34000	1952	0.69	153	0.42	47	0.27	17
36000	2067	0.73	170	0.44	52	0.29	18
38000	2182	0.77	187	0.47	57	0.30	20
40000	2297	0.81	204	0.49	63	0.32	22
42000	2411	0.85	223	0.52	68	0.33	24
44000	2526	0.89	242	0.54	74	0.35	26
46000	2641	0.93	263	0.57	80	0.37	28
48000	2756	0.97	283	0.59	86	0.38	30
50000	2871	1.01	304	0.62	93	0.40	33
55000	3158	1.11	361	0.68	110	0.44	39
60000	3445	1.21	422	0.74	129	0.48	45
65000	3732	1.31	487	0.80	148	0.52	52
70000	4019	1.41	556	0.86	169	0.56	60
75000	4306	1.51	629	0.92	192	0.60	67
80000	4593			0.98	215	0.64	76
85000	4880			1.05	240	0.68	84
90000	5167			1.11	266	0.72	93
95000	5455			1.17	293	0.76	103
100000	5742			1.23	321	0.80	113
105000	6029			1.29	351	0.84	123
110000	6316			1.35	381	0.87	134
115000	6603			1.42	413	0.91	145
120000	6890			1.48	446	0.95	156
125000	7177			1.54	480	0.99	168
130000	7464					1.03	180
140000	8038					1.11	206
150000	8612					1.19	233
160000	9187					1.27	262
170000	9761					1.35	292
180000	10335					1.43	324
190000	10909					1.51	357
200000	11483					1.59	392
210000	12057					1.67	428
220000	12632					1.75	466
230000	13206					1.83	505
240000	13780					1.91	545
250000	14354					1.99	587

Q = Power in Watt, v = Flow velocity in metres/second

R = Pipe friction pressure gradient in Pascal/Meter (100 Pa = 1 hPa = 1 mbar, 1 hPa ~ 10 mm WS)

Heating mode: $\Delta\theta = 15\text{ K}$ (70 °C/55 °C) - 75 — 110 mm

OD x s (ID) — V/I		75 x 7,5 mm (60 mm) — 2.83 l/m		90 x 8,5 mm (73 mm) — 4.18 l/m		110 x 10 mm (90 mm) — 6.36 l/m	
Q, W	m, kg/h	v, m/s	R, Pa/m	v, m/s	R, Pa/m	v, m/s	R, Pa/m
40000	2297	0.23	10	0.16	4	0.10	1
50000	2871	0.29	15	0.19	6	0.13	2
60000	3445	0.34	21	0.23	8	0.15	3
70000	4019	0.40	27	0.27	11	0.18	4
80000	4593	0.46	35	0.31	14	0.20	5
90000	5167	0.52	43	0.35	17	0.23	6
100000	5742	0.57	52	0.39	20	0.26	7
110000	6316	0.63	61	0.43	24	0.28	9
120000	6890	0.69	72	0.47	28	0.31	10
130000	7464	0.75	83	0.50	32	0.33	12
140000	8038	0.80	95	0.54	37	0.36	14
150000	8612	0.86	107	0.58	42	0.38	15
160000	9187	0.92	120	0.62	47	0.41	17
170000	9761	0.98	134	0.66	52	0.43	19
180000	10335	1.03	148	0.70	58	0.46	21
190000	10909	1.09	164	0.74	64	0.49	23
200000	11483	1.15	180	0.78	70	0.51	26
220000	12632	1.26	213	0.85	83	0.56	30
240000	13780	1.38	249	0.93	97	0.61	36
260000	14928	1.49	288	1.01	112	0.66	41
280000	16077	1.61	329	1.09	128	0.72	47
300000	17225	1.72	373	1.16	145	0.77	53
320000	18373	1.84	419	1.24	163	0.82	60
340000	19522	1.95	468	1.32	182	0.87	67
360000	20670	2.07	519	1.40	202	0.92	74
380000	21818			1.48	223	0.97	81
400000	22967			1.55	244	1.02	89
420000	24115			1.63	267	1.07	97
440000	25263			1.71	290	1.12	106
460000	26411			1.79	315	1.17	115
480000	28560			1.86	340	1.23	124
500000	28708			1.94	366	1.28	134
520000	29856			2.02	393	1.33	143
540000	31005					1.38	154
560000	32153					1.43	164
580000	33301					1.48	175
600000	34450					1.53	186
620000	35598					1.58	197
640000	36746					1.63	209
660000	37895					1.69	221
680000	39043					1.74	233
700000	40191					1.79	246
720000	41340					1.84	259
740000	42488					1.89	272
760000	43636					1.94	286
780000	44785					1.99	299
800000	45933					2.04	314
820000	47081					2.09	328
840000	48230					2.15	343
860000	49378					2.20	358

Q = Power in Watt, v = Flow velocity in metres/second

R = Pipe friction pressure gradient in Pascal/Meter (100 Pa = 1 hPa = 1 mbar, 1 hPa ~ 10 mm WS)

Heating mode: $\Delta\theta = 10\text{ K}$ (55 °C/45 °C) - 14 — 16 mm

OD x s (ID) — V/l		14 x 2 mm (10 mm) — 0.08 l/m		16 x 2 mm (12 mm) — 0.11 l/m	
Q, W	m, kg/h	v, m/s	R, Pa/m	v, m/s	R, Pa/m
200	17	0.06	11	0.04	5
300	26	0.09	22	0.06	9
400	34	0.12	36	0.09	15
500	43	0.15	52	0.11	22
600	52	0.19	71	0.13	30
700	60	0.22	93	0.15	39
800	69	0.25	116	0.17	49
900	78	0.28	142	0.19	60
1000	86	0.31	171	0.21	72
1100	95	0.34	201	0.24	85
1200	103	0.37	234	0.26	99
1300	112	0.40	268	0.28	113
1400	121	0.43	305	0.30	129
1500	129	0.46	343	0.32	145
1600	138	0.49	384	0.34	162
1700	146	0.52	427	0.36	180
1800	155	0.56	471	0.39	199
1900	164	0.59	517	0.41	218
2000	172	0.62	566	0.43	238
2100	181	0.65	616	0.45	259
2200	189	0.68	668	0.47	281
2300	198	0.71	722	0.49	304
2400	207	0.74	777	0.51	327
2500	215	0.77	835	0.54	351
2600	224	0.80	894	0.56	376
2700	233	0.83	955	0.58	402
2800	241	0.86	1018	0.60	428
2900	250	0.89	1082	0.62	455
3000	258	0.93	1148	0.64	483
3200	276	0.99	1286	0.69	540
3400	293	1.05	1430	0.73	601
3600	310			0.77	664
3800	327			0.81	730
4000	344			0.86	799
4200	362			0.90	870
4400	349			0.94	945
4600	396			0.99	1021
4800	413			1.03	1101
5000	431				
5200	448				
5400	465				
5600	482				
5800	500				
6000	517				
6200	534				
6400	551				
6600	568				
6800	586				
7000	603				
7200	620				

Q = Power in Watt, v = Flow velocity in metres/second

R = Pipe friction pressure gradient in Pascal/Meter (100 Pa = 1 hPa = 1 mbar, 1 hPa ~ 10 mm WS)

Heating mode: $\Delta\theta = 10\text{ K}$ (55 °C/45 °C) - 20 — 32 mm

OD x s (ID) — V/l		20 x 2,25 mm (15,5 mm) — 0.19 l/m		25 x 2,5 mm (20 mm) — 0.31 l/m		32 x 2 mm (26 mm) — 0.53 l/m	
Q, W	m, kg/h	v, m/s	R, Pa/m	v, m/s	R, Pa/m	v, m/s	R, Pa/m
500	43	0.06	7	0.04	2	0.02	1
1000	86	0.13	22	0.08	7	0.05	2
1500	129	0.19	43	0.12	13	0.07	4
2000	172	0.26	71	0.15	21	0.09	6
2500	215	0.32	104	0.19	31	0.11	9
3000	258	0.39	143	0.23	43	0.14	12
3500	301	0.45	188	0.27	56	0.16	16
4000	344	0.51	237	0.31	71	0.18	20
4500	388	0.58	291	0.35	87	0.21	25
5000	431	0.64	350	0.39	104	0.23	30
5500	474	0.71	414	0.42	123	0.25	35
6000	517	0.77	482	0.46	143	0.27	41
6500	560	0.83	555	0.50	165	0.30	47
7000	603	0.90	632	0.54	188	0.32	54
7500	646	0.96	714	0.58	212	0.34	61
8000	689	1.03	800	0.62	237	0.37	68
8500	732			0.66	264	0.39	76
9000	775			0.69	292	0.41	84
9500	818			0.73	321	0.43	92
10000	861			0.77	352	0.46	101
10500	904			0.81	383	0.48	110
11000	947			0.85	416	0.50	119
11500	990			0.89	450	0.52	129
12000	1033			0.93	486	0.55	139
12500	1077			0.96	522	0.57	149
13000	1120			1.00	560	0.59	160
13500	1163			1.04	598	0.62	171
14000	1206			1.08	638	0.64	182
14500	1249			1.12	679	0.66	194
15000	1292			1.16	721	0.68	206
16000	1378			1.23	809	0.73	231
17000	1464			1.31	901	0.78	257
18000	1550			1.39	997	0.82	285
19000	1636			1.47	1098	0.87	313
20000	1722			1.54	1203	0.91	343
21000	1809					0.96	374
22000	1895					1.00	406
23000	1981					1.05	440
24000	2067					1.10	474
25000	2153					1.14	510
26000	2239					1.19	547
27000	2325					1.23	585
28000	2411					1.28	624
29000	2498					1.32	665
30000	2584					1.37	706
31000	2670					1.41	749
32000	2756					1.46	792
33000	2842					1.51	837
34000	2928					1.55	883
35000	3014					1.60	930

Q = Power in Watt, v = Flow velocity in metres/second

R = Pipe friction pressure gradient in Pascal/Meter (100 Pa = 1 hPa = 1 mbar, 1 hPa ~ 10 mm WS)

Heating mode: $\Delta\theta = 10\text{ K}$ (55 °C/45 °C) - 40 — 63 mm

OD x s (ID) — V/I		40 x 4 mm (32 mm) — 0.80 l/m		50 x 4,5 mm (41 mm) — 1.32 l/m		63 x 6 mm (51 mm) — 2.04 l/m	
Q, W	m, kg/h	v, m/s	R, Pa/m	v, m/s	R, Pa/m	v, m/s	R, Pa/m
2000	172	0.06	2	0.04	1	0.02	1
4000	344	0.12	8	0.07	2	0.05	1
6000	517	0.18	15	0.11	5	0.07	2
8000	689	0.24	25	0.15	8	0.09	3
10000	861	0.30	38	0.18	12	0.12	4
12000	1033	0.36	52	0.22	16	0.14	6
14000	1206	0.42	68	0.26	21	0.17	7
16000	1378	0.48	86	0.29	26	0.19	9
18000	1550	0.54	106	0.33	32	0.21	11
20000	1722	0.60	127	0.37	39	0.24	14
22000	1895	0.66	151	0.40	46	0.26	16
24000	2067	0.72	176	0.44	54	0.28	19
26000	2239	0.78	203	0.48	62	0.31	22
28000	2411	0.84	231	0.51	71	0.33	25
30000	2584	0.90	261	0.55	80	0.36	28
32000	2756	0.96	293	0.59	90	0.38	32
34000	2928	1.02	327	0.62	100	0.40	35
36000	3100	1.08	362	0.66	111	0.43	39
38000	3273	1.14	398	0.70	122	0.45	43
40000	3445	1.20	437	0.73	133	0.47	47
42000	3617	1.27	476	0.77	145	0.50	51
44000	3789	1.33	518	0.81	158	0.52	56
46000	3962	1.39	561	0.84	171	0.55	60
48000	4134	1.45	605	0.88	185	0.57	65
50000	4306	1.51	651	0.92	199	0.59	70
55000	4737			1.01	235	0.65	83
60000	5167			1.10	275	0.71	97
65000	5598			1.19	317	0.77	112
70000	6029			1.28	362	0.83	127
75000	6459			1.38	410	0.89	144
80000	6890			1.47	461	0.95	162
85000	7321			1.56	514	1.01	180
90000	7751					1.07	200
95000	8182					1.13	220
100000	8612					1.19	241
105000	9043					1.25	263
110000	9474					1.30	286
115000	9904					1.36	310
120000	10335					1.42	335
125000	10766					1.48	360
130000	11196					1.54	387
135000	11627					1.60	414
140000	12057					1.66	442
145000	12488					1.72	471
150000	12919					1.78	500
155000	13349					1.84	531
160000	13780					1.90	562
165000	14211					1.96	594
170000	14641					2.02	627
175000	15072					2.08	661

Q = Power in Watt, v = Flow velocity in metres/second

R = Pipe friction pressure gradient in Pascal/Meter (100 Pa = 1 hPa = 1 mbar, 1 hPa ~ 10 mm WS)

Heating mode: $\Delta\theta = 10\text{ K}$ (55 °C/45 °C) - 75 — 110 mm

OD x s (ID) — V/I		75 x 7,5 mm (60 mm) — 2.83 l/m		90 x 8,5 mm (73 mm) — 4.18 l/m		110 x 10 mm (90 mm) — 6.36 l/m	
Q, W	m, kg/h	v, m/s	R, Pa/m	v, m/s	R, Pa/m	v, m/s	R, Pa/m
40000	3445	0.34	22	0.23	8	0.13	3
50000	4306	0.43	32	0.29	13	0.17	5
60000	5167	0.51	44	0.35	17	0.21	6
70000	6029	0.60	58	0.41	23	0.25	8
80000	6890	0.69	74	0.46	29	0.29	11
90000	7751	0.77	92	0.52	36	0.33	13
100000	8612	0.86	111	0.58	43	0.36	16
110000	9474	0.94	131	0.64	51	0.40	19
120000	10335	1.03	153	0.69	60	0.44	22
130000	11196	1.11	177	0.75	69	0.48	25
140000	12057	1.20	202	0.81	79	0.52	29
150000	12919	1.29	229	0.87	89	0.55	33
160000	13780	1.37	257	0.93	100	0.59	37
170000	14641	1.46	287	0.98	112	0.63	41
180000	15502	1.54	318	1.04	124	0.67	45
190000	16364	1.63	351	1.10	137	0.71	50
200000	17225	1.71	385	1.16	150	0.75	55
210000	18086	1.80	420	1.22	164	0.78	60
220000	18947	1.88	457	1.27	178	0.82	65
230000	19809	1.97	495	1.33	193	0.86	71
240000	20670	2.06	535	1.39	208	0.90	76
250000	21531			1.45	224	0.94	82
260000	22392			1.50	241	0.98	88
270000	23254			1.56	258	1.01	94
280000	24115			1.62	275	1.05	101
290000	24976			1.68	293	1.09	107
300000	25837			1.74	312	1.13	114
310000	26699			1.79	331	1.17	121
320000	27560			1.85	350	1.21	128
330000	28421			1.91	371	1.24	135
340000	29282			1.97	391	1.28	143
350000	30144			2.03	412	1.32	150
360000	31005					1.36	158
370000	31866					1.40	166
380000	32727					1.43	175
390000	33589					1.47	183
400000	34450					1.51	192
410000	35311					1.55	200
420000	36172					1.59	209
430000	37033					1.63	218
440000	37895					1.66	228
450000	38756					1.70	237
460000	39617					1.74	247
470000	40478					1.78	257
480000	41340					1.82	267
490000	42201					1.86	277
500000	43062					1.89	287
510000	43923					1.93	298
520000	44785					1.97	308
530000	45646					2.01	319

Q = Power in Watt, v = Flow velocity in metres/second

R = Pipe friction pressure gradient in Pascal/Meter (100 Pa = 1 hPa = 1 mbar, 1 hPa ~ 10 mm WS)

Heating mode: $\Delta\theta = 5 \text{ K}$ (50 °C/45 °C) - 14 — 16 mm

OD x s (ID) — V/I		14 x 2 mm (10 mm) — 0.08 l/m		16 x 2 mm (12 mm) — 0.11 l/m	
Q, W	m, kg/h	v, m/s	R, Pa/m	v, m/s	R, Pa/m
200	34	0.12	36	0.09	16
250	43	0.15	53	0.11	23
300	52	0.18	72	0.13	31
350	60	0.22	94	0.15	40
400	69	0.25	118	0.17	50
450	78	0.28	144	0.19	61
500	86	0.31	173	0.21	73
550	95	0.34	203	0.24	86
600	103	0.37	236	0.26	100
650	112	0.40	271	0.28	115
700	121	0.43	308	0.30	130
750	129	0.46	347	0.32	146
800	138	0.49	388	0.34	164
850	146	0.52	431	0.36	182
900	155	0.55	476	0.39	201
950	164	0.59	523	0.41	220
1000	172	0.62	571	0.43	241
1050	181	0.65	622	0.45	262
1100	189	0.68	674	0.47	284
1150	198	0.71	729	0.49	307
1200	207	0.74	785	0.51	330
1250	215	0.77	843	0.53	355
1300	224	0.80	902	0.56	380
1350	233	0.83	964	0.58	406
1400	241	0.86	1027	0.60	432
1450	250	0.89	1092	0.62	459
1500	258	0.92	1159	0.64	487
1550	267	0.96	1227	0.66	516
1600	276	0.99	1298	0.68	546
1650	284	1.02	1370	0.71	576
1700	293			0.73	607
1750	301			0.75	638
1800	310			0.77	670
1850	319			0.79	703
1900	327			0.81	737
1950	336			0.83	771
2000	344			0.86	806
2100	362			0.90	878
2200	379			0.94	953
2300	396			0.98	1030
2400	413			1.03	1111
2500	431				
2600	448				
2700	465				
2800	482				
3900	500				
3000	517				
3100	534				
3200	551				
3300	568				

Q = Power in Watt, v = Flow velocity in metres/second

R = Pipe friction pressure gradient in Pascal/Meter (100 Pa = 1 hPa = 1 mbar, 1 hPa ~ 10 mm WS)

Heating mode: $\Delta\theta = 5 \text{ K}$ (50 °C/45 °C) - 20 — 32 mm

OD x s (ID) — V/l		20 x 2,25 mm (15,5 mm) — 0.19 l/m		25 x 2,5 mm (20 mm) — 0.31 l/m		32 x 2 mm (26 mm) — 0.53 l/m	
Q, W	m, kg/h	v, m/s	R, Pa/m	v, m/s	R, Pa/m	v, m/s	R, Pa/m
400	69	0.10	15	0.06	5	0.04	1
600	103	0.15	30	0.09	9	0.05	3
800	138	0.21	49	0.12	15	0.07	4
1000	172	0.26	72	0.15	22	0.09	6
1200	207	0.31	98	0.18	29	0.11	9
1400	241	0.36	128	0.22	38	0.13	11
1600	276	0.41	162	0.25	48	0.15	14
1800	310	0.46	199	0.28	59	0.16	17
2000	344	0.51	239	0.31	71	0.18	21
2200	379	0.56	282	0.34	84	0.20	24
2400	413	0.62	329	0.37	98	0.22	28
2600	448	0.67	378	0.40	113	0.24	32
2800	482	0.72	431	0.43	128	0.26	37
3000	517	0.77	486	0.46	145	0.27	42
3200	551	0.82	545	0.49	162	0.29	47
3400	586	0.87	606	0.52	180	0.31	52
3600	620	0.92	670	0.55	199	0.33	57
3800	655	0.97	737	0.59	219	0.35	63
4000	689	1.03	807	0.62	240	0.36	69
4200	723			0.65	261	0.38	75
4400	758			0.68	283	0.40	81
4600	792			0.71	306	0.42	88
4800	827			0.74	330	0.44	95
5000	861			0.77	355	0.46	102
5200	896			0.80	380	0.47	109
5400	930			0.83	407	0.49	116
5600	965			0.86	434	0.51	124
5800	999			0.89	461	0.53	132
6000	1033			0.92	490	0.55	140
6500	1120			1.00	564	0.59	161
7000	1206			1.08	643	0.64	184
7500	1292			1.16	727	0.68	208
8000	1378			1.23	815	0.73	233
8500	1464			1.31	908	0.77	259
9000	1550			1.39	1005	0.82	287
9500	1636			1.46	1107	0.87	316
10000	1722			1.54	1213	0.91	346
10500	1809					0.96	377
11000	1895					1.00	410
11500	1981					1.05	443
12000	2067					1.09	478
12500	2153					1.14	514
13000	2239					1.18	551
13500	2325					1.23	590
14000	2411					1.28	629
14500	2498					1.32	670
15000	2584					1.37	712
15500	2670					1.41	755
16000	2756					1.46	799
16500	2842					1.50	844

Q = Power in Watt, v = Flow velocity in metres/second

R = Pipe friction pressure gradient in Pascal/Meter (100 Pa = 1 hPa = 1 mbar, 1 hPa ~ 10 mm WS)

Heating mode: $\Delta\theta = 5 \text{ K}$ (50 °C/45 °C) - 40 — 63 mm

OD x s (ID) — V/I		40 x 4 mm (32 mm) — 0.80 l/m		50 x 4,5 mm (41 mm) — 1.32 l/m		63 x 6 mm (51 mm) — 2.04 l/m	
Q, W	m, kg/h	v, m/s	R, Pa/m	v, m/s	R, Pa/m	v, m/s	R, Pa/m
4000	689	0.24	26	0.15	8	0.09	3
5000	861	0.30	38	0.18	12	0.12	4
6000	1033	0.36	52	0.22	16	0.14	6
7000	1206	0.42	68	0.26	21	0.17	7
8000	1378	0.48	87	0.29	27	0.19	9
9000	1550	0.54	107	0.33	33	0.21	12
10000	1722	0.60	128	0.37	39	0.24	14
11000	1895	0.66	152	0.40	47	0.26	16
12000	2067	0.72	177	0.44	54	0.28	19
13000	2239	0.78	204	0.48	63	0.31	22
14000	2411	0.84	233	0.51	71	0.33	25
15000	2584	0.90	264	0.55	81	0.36	28
16000	2756	0.96	296	0.59	90	0.38	32
17000	2928	1.02	329	0.62	101	0.40	36
18000	3100	1.08	365	0.66	111	0.43	39
19000	3273	1.14	402	0.70	123	0.45	43
20000	3445	1.20	440	0.73	134	0.47	47
22000	3789	1.32	522	0.81	159	0.52	56
24000	4134	1.44	610	0.88	186	0.57	66
26000	4478	1.56	704	0.95	215	0.62	76
28000	4823			1.03	245	0.66	86
30000	5167			1.10	277	0.71	97
32000	5512			1.17	311	0.76	109
34000	5856			1.25	347	0.81	122
36000	6201			1.32	384	0.85	135
38000	6545			1.39	423	0.90	149
40000	6890			1.47	464	0.95	163
42000	7234			1.54	506	0.99	178
44000	7579					1.04	193
46000	7923					1.09	209
48000	8268					1.14	226
50000	8612					1.18	243
52000	8957					1.23	261
54000	9301					1.28	279
56000	9646					1.33	298
58000	9990					1.37	317
60000	10335					1.42	337
62000	10679					1.47	358
64000	11024					1.52	379
66000	11368					1.56	400
68000	11713					1.61	422
70000	12057					1.66	445
72000	12402					1.71	468
74000	12746					1.75	492
76000	13091					1.80	516
78000	13435					1.85	541
80000	13780					1.90	566
82000	14124					1.94	592
84000	14469					1.99	618
86000	14813					2.04	645

Q = Power in Watt, v = Flow velocity in metres/second

R = Pipe friction pressure gradient in Pascal/Meter (100 Pa = 1 hPa = 1 mbar, 1 hPa ~ 10 mm WS)

Heating mode: $\Delta\theta = 5 \text{ K}$ (50 °C/45 °C) - 75 — 110 mm

OD x s (ID) — V/I		75 x 7,5 mm (60 mm) — 2.83 l/m		90 x 8,5 mm (73 mm) — 4.18 l/m		110 x 10 mm (90 mm) — 6.36 l/m	
Q, W	m, kg/h	v, m/s	R, Pa/m	v, m/s	R, Pa/m	v, m/s	R, Pa/m
20000	3445	0.34	22	0.23	9	0.15	3
25000	4306	0.43	32	0.29	13	0.19	5
30000	5167	0.51	45	0.35	18	0.23	6
35000	6029	0.60	59	0.40	23	0.27	8
40000	6890	0.69	75	0.46	29	0.30	11
45000	7751	0.77	92	0.52	36	0.34	13
50000	8612	0.86	112	0.58	44	0.38	16
55000	9474	0.94	132	0.64	52	0.42	19
60000	10335	1.03	155	0.69	60	0.46	22
65000	11196	1.11	178	0.75	70	0.49	26
70000	12057	1.20	204	0.81	80	0.53	29
75000	12919	1.28	231	0.87	90	0.57	33
80000	13780	1.37	259	0.93	101	0.61	37
85000	14641	1.45	289	0.98	113	0.65	41
90000	15502	1.54	321	1.04	125	0.68	46
95000	16364	1.63	353	1.10	138	0.72	50
100000	17225	1.71	388	1.16	151	0.76	55
105000	18086	1.80	423	1.21	165	0.80	60
110000	18947	1.88	460	1.27	179	0.84	66
115000	19809	1.97	499	1.33	194	0.87	71
120000	20670	2.05	539	1.39	210	0.91	77
125000	21531			1.45	226	0.95	83
130000	22392			1.50	242	0.99	89
135000	23254			1.56	260	1.03	95
140000	24115			1.62	277	1.06	101
145000	24976			1.68	295	1.10	108
150000	25837			1.73	314	1.14	115
155000	26699			1.79	333	1.18	122
160000	27560			1.85	353	1.22	129
165000	28421			1.91	373	1.26	136
170000	29282			1.97	394	1.29	144
175000	30144			2.02	415	1.33	152
180000	31005					1.37	159
185000	31866					1.41	168
190000	32727					1.45	176
195000	33589					1.48	184
200000	34450					1.52	193
205000	35311					1.56	202
210000	36172					1.60	211
215000	37033					1.64	220
220000	37895					1.67	229
225000	38756					1.71	239
230000	39617					1.75	248
235000	40478					1.79	258
240000	41340					1.83	268
245000	42201					1.86	279
250000	43062					1.90	289
255000	43923					1.94	300
260000	44785					1.98	310
265000	45646					2.02	321

Q = Power in Watt, v = Flow velocity in metres/second

R = Pipe friction pressure gradient in Pascal/Meter (100 Pa = 1 hPa = 1 mbar, 1 hPa ~ 10 mm WS)

Cooling mode: $\Delta\theta = 6 \text{ K (6 °C/12 °C)}$ - 14 — 16 mm

OD x s (ID) — V/l		14 x 2 mm (10 mm) — 0.08 l/m		16 x 2 mm (12 mm) — 0.11 l/m	
Q, W	m, kg/h	v, m/s	R, Pa/m	v, m/s	R, Pa/m
-100	14	0.05	12	0.04	5
-200	29	0.10	36	0.07	15
-300	43	0.15	69	0.11	30
-400	57	0.20	112	0.14	48
-500	72	0.25	162	0.18	69
-600	86	0.30	220	0.21	94
-700	100	0.36	286	0.25	122
-800	115	0.41	358	0.28	152
-900	129	0.46	437	0.32	186
-1000	144	0.51	523	0.35	222
-1100	158	0.56	615	0.39	261
-1200	172	0.61	714	0.42	303
-1300	187	0.66	818	0.46	347
-1400	201	0.71	929	0.49	394
-1500	215	0.76	1046	0.53	443
-1600	230	0.81	1169	0.56	495
-1700	244	0.86	1297	0.60	549
-1800	258	0.91	1432	0.63	605
-1900	273	0.96	1572	0.67	664
-2000	287	1.02	1717	0.71	726
-2100	301			0.74	789
-2200	316			0.78	855
-2300	330			0.81	923
-2400	344			0.85	994
-2500	359			0.88	1066
-2600	373			0.92	1141
-2700	388			0.95	1218
-2800	402			0.99	1297
-2900	416			1.02	1379
-3000	431				
-3100	445				
-3200	459				
-3300	474				
-3400	488				
-3500	502				
-3600	517				
-3700	531				
-3800	545				
-3900	560				
-4000	574				
-4100	589				
-4200	603				
-4300	617				
-4400	632				
-4500	646				
-4600	660				
-4700	675				
-4800	689				
-4900	703				
-5000	718				

Q = Power in Watt, v = Flow velocity in metres/second

R = Pipe friction pressure gradient in Pascal/Meter (100 Pa = 1 hPa = 1 mbar, 1 hPa ~ 10 mm WS)

Cooling mode: $\Delta\theta = 6 \text{ K}$ (6 °C/12 °C) - 20 — 32 mm

OD x s (ID) — V/l		20 x 2,25 mm (15,5 mm) — 0.19 l/m		25 x 2,5 mm (20 mm) — 0.31 l/m		32 x 2 mm (26 mm) — 0.53 l/m	
Q, W	m, kg/h	v, m/s	R, Pa/m	v, m/s	R, Pa/m	v, m/s	R, Pa/m
-400	57	0.08	15	0.05	4	0.03	1
-600	86	0.13	28	0.08	9	0.05	3
-800	115	0.17	46	0.10	14	0.06	4
-1000	144	0.21	67	0.13	20	0.08	6
-1200	172	0.25	91	0.15	28	0.09	8
-1400	201	0.30	118	0.18	36	0.11	10
-1600	230	0.34	148	0.20	45	0.12	13
-1800	258	0.38	181	0.23	55	0.14	16
-2000	287	0.42	217	0.25	65	0.15	19
-2200	316	0.47	255	0.28	77	0.17	22
-2400	344	0.51	297	0.30	89	0.18	26
-2600	373	0.55	340	0.33	102	0.20	30
-2800	402	0.59	387	0.36	116	0.21	34
-3000	431	0.63	436	0.38	131	0.23	38
-3200	459	0.68	487	0.41	146	0.24	42
-3400	488	0.72	541	0.43	162	0.26	47
-3600	517	0.76	597	0.46	179	0.27	52
-3800	545	0.80	656	0.48	196	0.29	57
-4000	574	0.85	717	0.51	214	0.30	62
-4200	603	0.89	780	0.53	233	0.32	68
-4400	632	0.93	846	0.56	253	0.33	73
-4600	660	0.97	914	0.58	273	0.35	79
-4800	689	1.01	984	0.61	294	0.36	85
-5000	718			0.63	316	0.38	91
-5500	789			0.70	372	0.41	108
-6000	861			0.76	433	0.45	125
-6500	933			0.83	498	0.49	144
-7000	1005			0.89	567	0.53	163
-7500	1077			0.95	639	0.56	184
-8000	1148			1.02	715	0.60	206
-8500	1220			1.08	796	0.64	229
-9000	1292			1.14	879	0.68	253
-9500	1364			1.21	964	0.71	278
-10000	1435			1.27	1058	0.75	304
-10500	1507			1.33	1152	0.79	331
-11000	1579			1.40	1250	0.83	359
-11500	1651			1.46	1352	0.86	388
-12000	1722			1.52	1457	0.90	418
-12500	1794					0.94	449
-13000	1866					0.98	481
-13500	1938					1.01	514
-14000	2010					1.05	548
-14500	2081					1.09	583
-15000	2153					1.13	619
-16000	2297					1.20	693
-17000	2440					1.28	771
-18000	2584					1.35	853
-19000	2727					1.43	938
-20000	2871					1.50	1027
-21000	3014					1.58	1120

Q = Power in Watt, v = Flow velocity in metres/second

R = Pipe friction pressure gradient in Pascal/Meter (100 Pa = 1 hPa = 1 mbar, 1 hPa ~ 10 mm WS)

Cooling mode: $\Delta\theta = 6\text{ K}$ (6 °C/12 °C) - 40 — 63 mm

OD x s (ID) — V/I		40 x 4 mm (32 mm) — 0.80 l/m		50 x 4,5 mm (41 mm) — 1.32 l/m		63 x 6 mm (51 mm) — 2.04 l/m	
Q, W	m, kg/h	v, m/s	R, Pa/m	v, m/s	R, Pa/m	v, m/s	R, Pa/m
-4000	574	0.20	23	0.12	7	0.08	3
-6000	861	0.30	47	0.18	15	0.12	5
-8000	1148	0.40	77	0.24	24	0.16	9
-10000	1435	0.50	114	0.30	35	0.20	12
-12000	1722	0.60	156	0.36	48	0.23	17
-14000	2010	0.69	204	0.42	63	0.27	22
-16000	2297	0.79	258	0.48	79	0.31	28
-18000	2584	0.89	317	0.54	98	0.35	35
-20000	2871	0.99	382	0.60	117	0.39	42
-22000	3158	1.09	452	0.66	139	0.43	49
-24000	3445	1.19	527	0.73	162	0.47	57
-26000	3732	1.29	607	0.79	186	0.51	66
-28000	4019	1.39	692	0.85	212	0.55	75
-30000	4306	1.49	781	0.91	240	0.59	85
-32000	4593	1.59	876	0.97	269	0.62	95
-34000	4880			1.03	299	0.66	106
-36000	5167			1.09	331	0.70	117
-38000	5455			1.15	364	0.74	129
-40000	5742			1.21	399	0.78	141
-42000	6029			1.27	435	0.82	153
-44000	6316			1.33	472	0.86	167
-46000	6603			1.39	511	0.90	180
-48000	6890			1.45	551	0.94	194
-50000	7177			1.51	592	0.98	209
-52000	7464					1.02	224
-54000	7751					1.05	239
-56000	8038					1.09	255
-58000	8325					1.13	272
-60000	8612					1.17	289
-62000	8900					1.21	306
-64000	9187					1.25	324
-66000	9474					1.29	342
-68000	9761					1.33	360
-70000	10048					1.37	379
-72000	10335					1.41	399
-74000	10622					1.44	419
-76000	10909					1.48	439
-78000	11196					1.52	460
-80000	11483					1.56	481
-82000	11770					1.60	503
-84000	12057					1.64	525
-86000	12344					1.68	547
-88000	12632					1.72	570
-90000	12919					1.76	594
-92000	13206					1.80	618
-94000	13493					1.84	642
-96000	13780					1.87	666
-98000	14067					1.91	691
-100000	14354					1.95	717
-102000	14641					1.99	742

Q = Power in Watt, v = Flow velocity in metres/second

R = Pipe friction pressure gradient in Pascal/Meter (100 Pa = 1 hPa = 1 mbar, 1 hPa ~ 10 mm WS)

Cooling mode: $\Delta\theta = 6 \text{ K}$ (6 °C/12 °C) - 75 — 110 mm

OD x s (ID) — V/l		75 x 7,5 mm (60 mm) — 2.83 l/m		90 x 8,5 mm (73 mm) — 4.18 l/m		110 x 10 mm (90 mm) — 6.36 l/m	
Q, W	m, kg/h	v, m/s	R, Pa/m	v, m/s	R, Pa/m	v, m/s	R, Pa/m
-10000	1435	0.14	6	0.10	2	0.06	1
-15000	2153	0.21	12	0.14	5	0.09	2
-20000	2871	0.28	19	0.19	8	0.13	3
-25000	3589	0.35	28	0.24	11	0.16	4
-30000	4306	0.42	39	0.29	15	0.19	6
-35000	5024	0.49	51	0.33	20	0.22	7
-40000	5742	0.56	65	0.38	26	0.25	9
-45000	6459	0.63	80	0.43	31	0.28	12
-50000	7177	0.71	96	0.48	38	0.31	14
-55000	7895	0.78	114	0.52	45	0.34	16
-60000	8612	0.85	133	0.57	52	0.38	19
-65000	9330	0.92	153	0.62	60	0.41	22
-70000	10048	0.99	175	0.67	68	0.44	25
-75000	10766	1.06	197	0.71	77	0.47	28
-80000	11483	1.13	221	0.76	87	0.50	32
-85000	12201	1.20	246	0.81	97	0.53	36
-90000	12919	1.27	273	0.86	107	0.56	39
-95000	13636	1.34	300	0.91	118	0.60	43
-100000	14354	1.41	329	0.95	129	0.63	47
-105000	15072	1.48	359	1.00	141	0.66	52
-110000	15789	1.55	390	1.05	153	0.69	56
-115000	16507	1.62	422	1.10	165	0.72	61
-120000	17225	1.69	456	1.14	178	0.75	66
-125000	17943	1.76	490	1.19	192	0.78	70
-130000	18660	1.83	526	1.24	206	0.82	76
-135000	19378	1.90	563	1.29	220	0.85	81
-140000	20096	1.97	601	1.33	235	0.88	86
-145000	20813	2.05	640	1.38	250	0.91	92
-150000	21531			1.43	266	0.94	97
-160000	22967			1.52	298	1.00	109
-170000	24402			1.62	332	1.07	122
-180000	25837			1.72	368	1.13	135
-190000	27273			1.81	405	1.19	149
-200000	28708			1.91	444	1.25	163
-210000	30144			2.00	485	1.32	178
-220000	31579					1.38	193
-230000	33014					1.44	209
-240000	34450					1.50	226
-250000	35885					1.57	243
-260000	37321					1.63	261
-270000	38756					1.69	279
-280000	40191					1.76	298
-290000	41627					1.82	317
-300000	43062					1.88	337
-310000	44498					1.94	358
-320000	45933					2.01	379
-330000	47368					2.07	400
-340000	48804					2.13	422
-350000	50239					2.19	445
-360000	51675					2.26	468

Q = Power in Watt, v = Flow velocity in metres/second

R = Pipe friction pressure gradient in Pascal/Meter (100 Pa = 1 hPa = 1 mbar, 1 hPa ~ 10 mm WS)

Cooling mode: $\Delta\theta = 3\text{ K}$ (17 °C/20 °C) - 14 — 16 mm

OD x s (ID) — V/l		14 x 2 mm (10 mm) — 0.08 l/m		16 x 2 mm (12 mm) — 0.11 l/m	
Q, W	m, kg/h	v, m/s	R, Pa/m	v, m/s	R, Pa/m
-50	14	0.05	11	0.04	5
-100	29	0.10	33	0.07	14
-150	43	0.15	64	0.11	27
-200	57	0.20	103	0.14	44
-250	72	0.25	149	0.18	64
-300	86	0.31	203	0.21	86
-350	100	0.36	264	0.25	112
-400	115	0.41	332	0.28	141
-450	129	0.46	405	0.32	172
-500	144	0.51	485	0.35	206
-550	158	0.56	572	0.39	242
-600	172	0.61	664	0.42	281
-650	187	0.66	762	0.46	322
-700	201	0.71	866	0.49	366
-750	215	0.76	975	0.53	412
-800	230	0.81	1090	0.57	460
-850	244	0.86	1211	0.60	511
-900	258	0.92	1337	0.64	564
-950	273	0.97	1468	0.67	619
-1000	287	1.02	1605	0.71	677
-1050	301			0.74	736
-1100	316			0.78	798
-1150	330			0.81	862
-1200	344			0.85	928
-1250	359			0.88	996
-1300	373			0.92	1067
-1350	388			0.95	1139
-1400	402			0.99	1213
-1450	416			1.02	1290
-1500	431				
-1550	445				
-1600	459				
-1650	474				
-1700	488				
-1750	502				
-1800	517				
-1850	531				
-1900	545				
-1950	560				
-2000	574				
-2050	589				
-2100	603				
-2150	617				
-2200	632				
-2250	646				
-2300	660				
-2350	675				
-2400	689				
-2450	703				
-2500	718				

Q = Power in Watt, v = Flow velocity in metres/second

R = Pipe friction pressure gradient in Pascal/Meter (100 Pa = 1 hPa = 1 mbar, 1 hPa ~ 10 mm WS)

Cooling mode: $\Delta\theta = 3 \text{ K}$ (17 °C/20 °C) - 20 — 32 mm

OD x s (ID) — V/l		20 x 2,25 mm (15,5 mm) — 0.19 l/m		25 x 2,5 mm (20 mm) — 0.31 l/m		32 x 2 mm (26 mm) — 0.53 l/m	
Q, W	m, kg/h	v, m/s	R, Pa/m	v, m/s	R, Pa/m	v, m/s	R, Pa/m
-200	57	0.08	13	0.05	4	0.03	1
-400	115	0.17	42	0.10	13	0.06	4
-600	172	0.25	84	0.15	25	0.09	7
-800	230	0.34	138	0.20	41	0.12	12
-1000	287	0.42	202	0.25	61	0.15	18
-1200	344	0.51	276	0.31	83	0.18	24
-1400	402	0.59	361	0.36	108	0.21	31
-1600	459	0.68	455	0.41	136	0.24	39
-1800	517	0.76	558	0.46	167	0.27	48
-2000	574	0.85	671	0.51	200	0.30	58
-2200	632	0.93	792	0.56	236	0.33	68
-2400	689	1.02	922	0.61	275	0.36	79
-2600	746			0.66	316	0.39	91
-2800	804			0.71	360	0.42	104
-3000	861			0.76	406	0.45	117
-3200	919			0.81	454	0.48	131
-3400	976			0.86	505	0.51	145
-3600	1033			0.92	559	0.54	161
-3800	1091			0.97	614	0.57	177
-4000	1148			1.02	672	0.60	193
-4200	1206			1.07	732	0.63	210
-4400	1263			1.12	794	0.66	228
-4600	1321			1.17	859	0.69	247
-4800	1378			1.22	926	0.72	266
-5000	1435			1.27	995	0.75	285
-5200	1493			1.32	1066	0.78	306
-5400	1550			1.37	1139	0.81	327
-5600	1608			1.42	1215	0.84	348
-5800	1665			1.47	1293	0.87	370
-6000	1722			1.53	1372	0.90	393
-6200	1780					0.93	417
-6400	1837					0.96	440
-6600	1895					0.99	465
-6800	1952					1.02	490
-7000	2010					1.05	516
-7200	2067					1.08	542
-7400	2124					1.11	569
-7600	2182					1.14	596
-7800	2239					1.17	624
-8000	2297					1.20	653
-8200	2354					1.23	682
-8400	2411					1.26	712
-8600	2469					1.29	742
-8800	2526					1.32	773
-9000	2584					1.35	804
-9200	2641					1.38	836
-9400	2699					1.41	868
-9600	2756					1.44	901
-9800	2813					1.47	935
-10000	2871					1.50	969

Q = Power in Watt, v = Flow velocity in metres/second

R = Pipe friction pressure gradient in Pascal/Meter (100 Pa = 1 hPa = 1 mbar, 1 hPa ~ 10 mm WS)

Cooling mode: $\Delta\theta = 3 \text{ K}$ (17 °C/20 °C) - 40 — 63 mm

OD x s (ID) — V/I		40 x 4 mm (32 mm) — 0.80 l/m		50 x 4,5 mm (41 mm) — 1.32 l/m		63 x 6 mm (51 mm) — 2.04 l/m	
Q, W	m, kg/h	v, m/s	R, Pa/m	v, m/s	R, Pa/m	v, m/s	R, Pa/m
-2000	574	0.20	22	0.12	7	0.08	2
-3000	861	0.30	44	0.18	14	0.12	5
-4000	1148	0.40	72	0.24	22	0.16	8
-5000	1435	0.50	106	0.30	33	0.20	12
-6000	1722	0.60	146	0.36	45	0.23	16
-7000	2010	0.70	192	0.42	59	0.27	21
-8000	2297	0.79	243	0.48	75	0.31	26
-9000	2584	0.89	299	0.54	92	0.35	33
-10000	2871	0.99	360	0.61	110	0.39	39
-11000	3158	1.09	426	0.67	131	0.43	46
-12000	3445	1.19	497	0.73	152	0.47	54
-13000	3732	1.29	572	0.79	175	0.51	62
-14000	4019	1.39	653	0.85	200	0.55	71
-15000	4306	1.49	738	0.91	226	0.59	80
-16000	4593	1.59	828	0.97	253	0.63	89
-17000	4880			1.03	282	0.66	100
-18000	5167			1.09	312	0.70	110
-19000	5455			1.15	344	0.74	121
-20000	5742			1.21	376	0.78	133
-21000	6029			1.27	411	0.82	145
-22000	6316			1.33	446	0.86	157
-23000	6603			1.39	483	0.90	170
-24000	6890			1.45	521	0.94	183
-25000	7177			1.51	560	0.98	197
-26000	7464					1.02	211
-27000	7751					1.06	226
-28000	8038					1.10	241
-29000	8325					1.13	257
-30000	8612					1.17	273
-31000	8900					1.21	289
-32000	9187					1.25	306
-33000	9474					1.29	323
-34000	9761					1.33	341
-35000	10048					1.37	359
-36000	10335					1.41	378
-37000	10622					1.45	397
-38000	10909					1.49	416
-39000	11196					1.53	436
-40000	11483					1.56	456
-41000	11770					1.60	476
-42000	12057					1.64	497
-43000	12344					1.68	519
-44000	12632					1.72	541
-45000	12919					1.76	563
-46000	13206					1.80	585
-47000	13493					1.84	608
-48000	13780					1.88	632
-49000	14067					1.92	656
-50000	14354					1.96	680
-51000	14641					1.99	704

Q = Power in Watt, v = Flow velocity in metres/second

R = Pipe friction pressure gradient in Pascal/Meter (100 Pa = 1 hPa = 1 mbar, 1 hPa ~ 10 mm WS)

Cooling mode: $\Delta\theta = 3 \text{ K}$ (17 °C/20 °C) - 75 — 110 mm

OD x s (ID) — V/l		75 x 7,5 mm (60 mm) — 2.83 l/m		90 x 8,5 mm (73 mm) — 4.18 l/m		110 x 10 mm (90 mm) — 6.36 l/m	
Q, W	m, kg/h	v, m/s	R, Pa/m	v, m/s	R, Pa/m	v, m/s	R, Pa/m
-8000	2297	0.23	12	0.15	5	0.10	2
-10000	2871	0.28	18	0.19	7	0.13	3
-12000	3445	0.34	25	0.23	10	0.15	4
-14000	4019	0.40	33	0.27	13	0.18	5
-16000	4593	0.45	41	0.31	16	0.20	6
-18000	5167	0.51	51	0.34	20	0.23	7
-20000	5742	0.57	61	0.38	24	0.25	9
-22000	6316	0.62	72	0.42	28	0.28	10
-24000	6890	0.68	84	0.46	33	0.30	12
-26000	7464	0.73	97	0.50	38	0.33	14
-28000	8038	0.79	111	0.53	44	0.35	16
-30000	8612	0.85	125	0.57	49	0.38	18
-32000	9187	0.90	141	0.61	55	0.40	20
-34000	9761	0.96	157	0.65	61	0.43	23
-36000	10335	1.02	174	0.69	68	0.45	25
-38000	10909	1.07	191	0.73	75	0.48	28
-40000	11483	1.13	209	0.76	82	0.50	30
-42000	12057	1.19	228	0.80	89	0.53	33
-44000	12632	1.24	248	0.84	97	0.55	36
-46000	13206	1.30	269	0.88	105	0.58	39
-48000	13780	1.36	290	0.92	113	0.60	42
-50000	14354	1.41	312	0.95	122	0.63	45
-52000	14928	1.47	335	0.99	131	0.65	48
-54000	15502	1.53	358	1.03	140	0.68	51
-56000	16077	1.58	382	1.07	149	0.70	55
-58000	16651	1.64	407	1.11	159	0.73	58
-60000	17225	1.70	432	1.15	169	0.75	62
-62000	17799	1.75	459	1.18	179	0.78	66
-64000	18373	1.81	485	1.22	190	0.80	70
-66000	18947	1.86	513	1.26	200	0.83	74
-68000	19522	1.92	541	1.30	211	0.85	78
-70000	20096	1.98	570	1.34	223	0.88	82
-75000	21531	2.12	645	1.43	252	0.94	92
-80000	22967			1.53	283	1.00	104
-85000	24402			1.62	315	1.07	116
-90000	25837			1.72	349	1.13	128
-95000	27273			1.81	385	1.19	141
-100000	28708			1.91	422	1.26	155
-105000	30144			2.00	461	1.32	169
-110000	31579					1.38	183
-115000	33014					1.44	199
-120000	34450					1.51	215
-125000	35885					1.57	231
-130000	37321					1.63	248
-135000	38756					1.70	265
-140000	40191					1.76	283
-145000	41627					1.82	302
-150000	43062					1.88	321
-155000	44498					1.95	340
-160000	45933					2.01	360

Q = Power in Watt, v = Flow velocity in metres/second

R = Pipe friction pressure gradient in Pascal/Meter (100 Pa = 1 hPa = 1 mbar, 1 hPa ~ 10 mm WS)

Sample calculation

Note

For system-connected heating circuits (single-pipe heating) the entire ring volume flow of all radiators must be taken into account!

The selection of the respective pipe dimension depends on the required mass flow (volume flow) for the respective section. Depending on pipe dimension OD x s, the flow velocity v and the pipe friction pressure gradient R change. If the pipe is sized too small, the flow velocity v and the pipe friction pressure gradient R increase. This leads to higher flow noises and higher power consumption of the circulation pump.

We therefore recommend that the following speed guide values are not exceeded when designing the pipe network:

- Radiator connection pipe: $v \leq 0.3$ m/s
- Heating distribution pipes: $v \leq 0.5$ m/s
- Heating riser and cellar pipes: $v \leq 1.0$ m/s

The pipe network must be designed in such a way that the flow velocity from the boiler to the most distant radiator decreases evenly. The guide values for the flow velocity must be observed.

The following tables show the maximum transferable heat output Q_N , taking into account the maximum flow velocity, depending on the type of piping, the expansion $\Delta\vartheta$ and the pipe dimension OD x s.

Radiator connection pipe: $v \leq 0.3$ m/s

Pipe OD x s [mm]	14 x 2	16 x 2	20 x 2.25	25 x 2.5	32 x 3
Mass flow \dot{m} (kg/h)	85	122	204	339	573
Heat output Q_N (W) at $\Delta\vartheta = 5$ K	493	710	1185	1972	3333
Heat output Q_N (W) at $\Delta\vartheta = 10$ K	986	1420	2369	3944	6666
Heat output Q_N (W) at $\Delta\vartheta = 15$ K	1479	2130	3554	5916	9999
Heat output Q_N (W) at $\Delta\vartheta = 20$ K	1972	2840	4738	7889	13332
Heat output Q_N (W) at $\Delta\vartheta = 25$ K	2465	3550	5923	9861	16665

Heating distribution pipes: $v \leq 0.5$ m/s

Pipe OD x s [mm]	14 x 2	16 x 2	20 x 2.25	25 x 2.5	32 x 3	40 x 4
Mass flow \dot{m} (kg/h)	141	204	340	565	956	1448
Heat output Q_N (W) at $\Delta\vartheta = 5$ K	822	1183	1974	3287	5555	8414
Heat output Q_N (W) at $\Delta\vartheta = 10$ K	1643	2367	3948	6574	11110	16829
Heat output Q_N (W) at $\Delta\vartheta = 15$ K	2465	3550	5923	9861	16665	25243
Heat output Q_N (W) at $\Delta\vartheta = 20$ K	3287	4733	7897	13148	22219	33658
Heat output Q_N (W) at $\Delta\vartheta = 25$ K	4109	5916	9871	16434	27774	42072

Heating riser and cellar pipes: $v \leq 1.0$ m/s

Pipe OD x s [mm]	14 x 2	16 x 2	20 x 2.25	25 x 2.5	32 x 3	40 x 4
Mass flow \dot{m} (kg/h)	283	407	679	1131	1911	2895
Heat output Q_N (W) at $\Delta\vartheta = 5$ K	1643	2367	3948	6574	11110	16829
Heat output Q_N (W) at $\Delta\vartheta = 10$ K	3287	4733	7897	13148	22219	33658
Heat output Q_N (W) at $\Delta\vartheta = 15$ K	4930	7100	11845	19721	33329	50487
Heat output Q_N (W) at $\Delta\vartheta = 20$ K	6574	9466	15794	26295	44439	67316
Heat output Q_N (W) at $\Delta\vartheta = 25$ K	8217	11833	19742	32869	55548	84144

Example

Calculation of mass flow \dot{m} (kg/h)	Where:
$\dot{m} = Q_N / [c_w \times (\vartheta_{VL} - \vartheta_{RL})]$	c_w = specific heat capacity of hot water ≈ 1.163 Wh/(kgK)
$\dot{m} = 1977 \text{ W} / [1.163 \text{ Wh}/(\text{kg K}) \times (70^\circ\text{C} - 50^\circ\text{C})]$	ϑ_{VL} = Flow temperature in $^\circ\text{C}$
$\dot{m} = 85$ kg/h	ϑ_{RL} = Return flow temperature in $^\circ\text{C}$
	Q_N = Rated power in W

12 Pressure and leak testing of Uponor heating installations

The following procedures describe the pressure and leak test for Uponor composite pipes and PE-Xa installation systems. Separate instructions and test protocols are available for pressure and leak testing of Uponor surface systems.

12.1 Leak test for heating installations with water

The heating engineer/installer must subject the heating pipes to a leak test after installation and before closing the wall slots, wall and ceiling openings and, if necessary, applying the screed or another covering. As a rule, tap water can be used for the leak test. The water should meet the requirements of VDI 2035. The heating system must be filled slowly and vented completely.

If there is a risk of freezing, suitable measures must be taken (e.g. use of antifreeze or temperature control of the building). If frost protection is no longer required for the intended operation of the system, antifreeze agents must be removed by draining and flushing the system with at least three (3) water changes.

The piping system and water heating systems must be tested at a pressure corresponding to the set pressure of the safety valve (DIN 18380, VOB). Alternatively, 1.3 times the operating pressure can be used as the test pressure for the pressure test in accordance with DIN EN 14336. Only pressure gauges which allow problem-free reading of a pressure change of 0.1 bar should be used. The pressure gauge should be placed at the lowest point of the system if possible.

The temperature compensation between ambient temperature and filling water temperature shall be taken into account by a corresponding waiting time after the test pressure has been established. If necessary, restore the test pressure after the waiting period. The test pressure must be maintained for two (2) hours and may not drop by more than 0.2 bar. No leaks must occur during that time.

The leak test must be documented in a pressure test report by the responsible specialist, taking into account the materials used. The tightness of the system must be verified and confirmed.

This report is available at the Uponor services download center.

<https://www.uponor.com/doc/1120121>



12.2 Leak test for heating installation with compressed air or inert gas

A pressure test for heating installations can be carried out with compressed air or inert gas in accordance with DIN EN 14336 or in accordance with the ZVSHK data sheet "Leak tests of drinking water distribution systems with compressed air, inert gas or water".

To document the test, the "leak test protocol for Uponor drinking water distribution - test medium: Compressed air or inert gases" is applicable.

This report is available at the Uponor services download center.

<https://www.uponor.com/doc/1120118>



13 General planning principles

13.1 Fire protection requirements

In Germany, the structural requirements for fire protection are a matter for the federal states, and are regulated in the state building regulations. Despite the introduction of a model building code MBO in 2002 and the fact that the model directive on the fire protection requirements MLAR 11/2005 was adopted as the cable installation directive in almost all federal states, there are still minor differences between the implementation requirements of the federal states.

In order to standardise the state building regulations, however, the paragraphs § 14 "Fire protection" and § 40 "Cables, piping systems, installation shafts, installation ducts" were essentially incorporated into the state building regulations as well as into the DVO and IVV implementation/execution regulations of the federal states.

Paragraph 14 makes all persons and companies involved in the project responsible. The terms "to order", "to erect", "to maintain" and "to change" are used here to address planners, architects and contractors as well as building owners or building operators who are under an ongoing obligation to maintain fire protection systems.

In order to guarantee preventive fire protection, the choice of the right building materials is existentially important. The selection of building materials is regulated in DIN 4102 (Fire behaviour of building materials and components), and this standard also contains a list of technical building regulations which must be observed.

In addition to DIN 4102, the European standard DIN EN 13501 "Classification of construction products and types of construction with regard to their reaction to fire" is also valid in Germany.

For the installation of a pipeline installation, the pipeline system guidelines (MLAR/LAR/RbALei) offer the possibility of installing sealing systems (e.g. fire protection sleeves and fire protection insulation) to comply with fire protection requirements. In the case of fire protection sealing systems, the installation rules of the general test certificates issued by the building authorities must be observed.

In addition, a declaration of conformity must be completed for each installation variant. Samples of these declarations of conformity are available from the respective product manufacturer. In the case of general approvals by the building authorities, type plates must also be mounted next to the partitioning systems.

13.2 Pipe insulation



Note

The planner and processor must be familiar with the relevant in force and continuously updated guidelines and laws of the federal states.

Insulation of pipelines reduces heat loss of heated water (PWH, PWH-C, heating pipelines) and reduces heating of cold drinking water (PWC) in pipes. However, insulation or cladding can also be useful or necessary against corrosion, condensation and sound transmission. The insulation requirements in new buildings as well as in existing buildings for hot and cold pipes are described in various standards and Ordinances (EnEV, DIN EN 806 - 2, DIN 1988-200).

Factory pre-insulated Uponor installation pipes offer decisive advantages over pipes insulated on site. On the one hand, they ensure rapid construction progress and at the same time they ensure that the insulation suitable for the specific insulation requirement will be used. The good thermal insulation properties of the insulation materials used allow small outside cut out diameters with optimum thermal insulation. By using eccentrically pre-insulated heating pipes in the floor structure, the required installation height can also be considerably reduced compared to comparable all-round insulation. This rectangular insulation can also be better integrated into the floor insulation.

14 Pressing tools for fitting assembly

14.1 System description

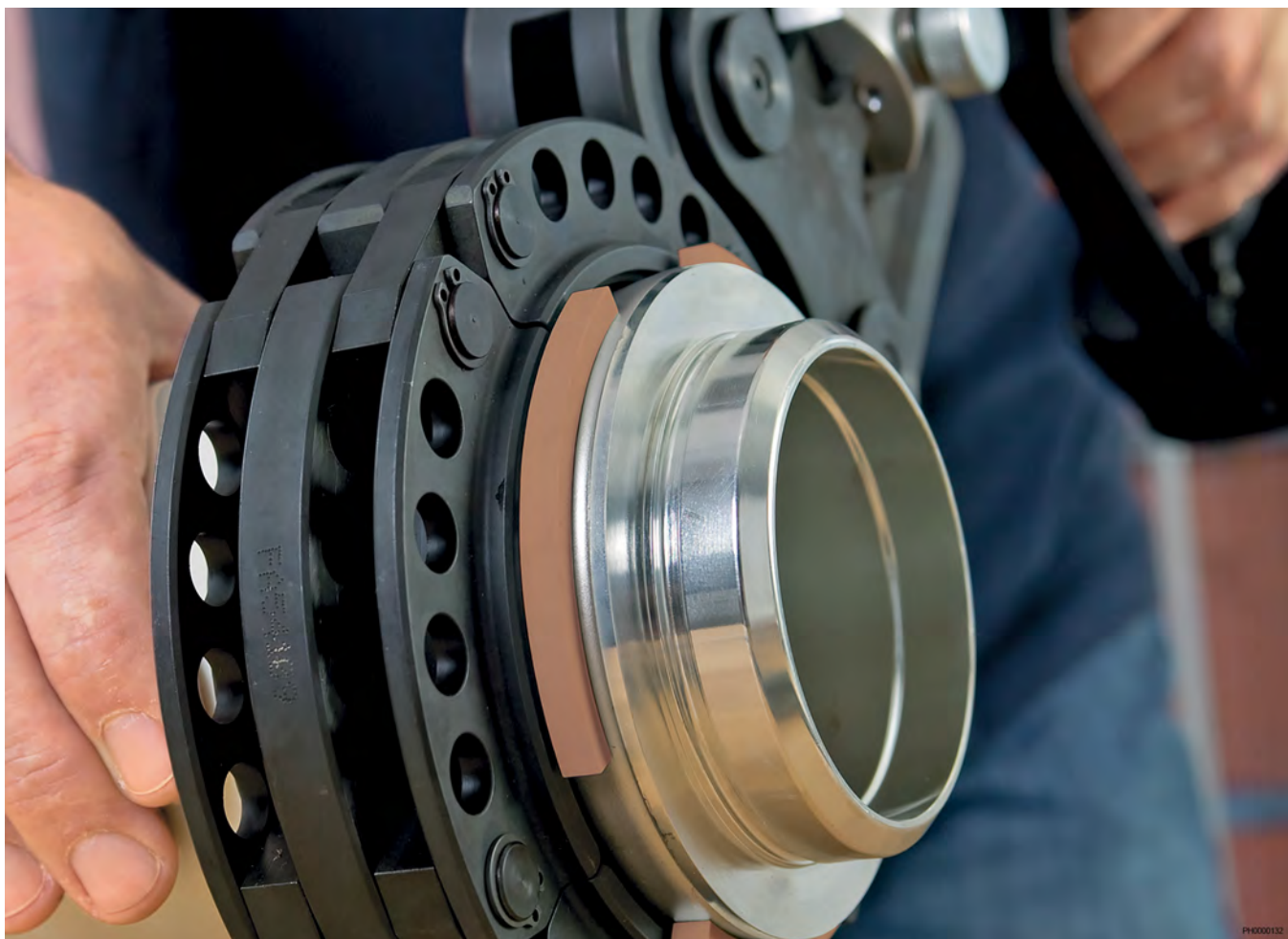

The Uponor system concept is based on the perfect interaction of all individual system components. Everything fits together and has been tested and approved by us for the respective area of application. In addition to high-quality installation components such as pipes, fittings and assembly accessories, we attach great importance to reliable and practical tool technology which is matched to the Uponor fitting systems. For example, the press jaws and press chains have the same dimension-specific colour coding as the Uponor press fittings so that nothing can be confused on the construction site.

Uponor pressing tools are an integral part of the Uponor declaration of liability and enable safe and uncomplicated fitting assembly.

- Proven press machines and press jaws from renowned manufacturers
- Pressing machines optionally as battery, 230 V or manual press pliers
- Dimension-specific color coding of the press jaws
- Part of the Uponor declaration of liability

14.2 Uponor pressing tool concept

Uponor press jaws MLC UPP1



PH0000133

Uponor press jaws MLC UPP1 with battery pressing machine UP 110 (as well as UP 75 and EL UP75)

Markings on the press jaw



CL0000409

Item	Description
A	Dimension
B	Maintenance sticker
C	Colour code dimension-specific

Markings on the press jaw UPP1



CD0000412

Item	Description
A	Dimension
B	Maintenance sticker
C	Colour code dimension-specific

Dimension-specific colour coding



RP0000221

Colour coding of Uponor S-Press PLUS fittings 16 — 32 mm

The colour coding on the Uponor press fittings and the Uponor press jaws indicates the associated dimensions.

Uponor press jaws MLC Mini KSP0







PH0000134



Uponor press jaws MLC Mini KSP0 with battery pressing machine Mini2

14.3 Overview tools for fitting assembly



Item	Description
A	Manual pressing tool + Interchangeable inserts
B	UP 110, battery tool or UP 75 EL, electrical tool 230 V + UPP1, pressing jaw
C	UP 110, battery tool or UP 75 EL, electrical tool 230 V + UPP1, pressing jaw
D	UP 110, battery tool or UP 75 EL, electrical tool 230 V + Basic press jaw with press chain
E	Mini2, battery tool + Mini KSP0, pressing jaw
F	Fixed wrench
G	Use only hands, no tools required

Uponor fittings	Uponor tools						
	A	B	C	D	E	F	G
 S-Press PLUS S-Press PLUS PPSU	16 — 20	16 — 32	—	—	16 — 32	—	—
 S-Press	14 — 20	14 — 32	—	—	14 — 32	—	—
 S-Press S-Press PPSU	—	—	40 — 50	63 — 75	—	—	—
 RS	—	16 — 32	40 — 50	63 — 110	16 — 32	—	—

Uponor fittings	Uponor tools						
	A	B	C	D	E	F	G
 PH0000083 Uni	—	—	—	—	—	14 — 25	—
 RP0000127 RTM	—	—	—	—	—	—	16 — 25

14.4 List of recommendations

Caution!
 This list does not apply to the GAS multilayer pipe system and its use in gas installations.

Uponor UPP1 pressing jaws and pressing chain are specially designed for use in conjunction with the Uponor UP 110 (1083612) and UP 75 battery-powered pressing machines and the Uponor UP 75 EL (1007082) electric pressing machine. Uponor Mini KSP0

pressing jaws are specially designed for use in conjunction with the Uponor Mini and Mini2 battery-powered pressing machines. When using other brands of pressing machines, you should have their suitability, warranty and occupational safety confirmed by the respective manufacturer. All Uponor press jaws are subject to an inspection cycle, described in the operating instructions. For use in drinking water distribution and heating installations, we recommend an inspection of the press jaws every 3 years.

Machine type (for Uponor UP 110 & UP 75)

Machine type (for Uponor UP 110 & UP 75)		Uponor press jaw dimensions			
Manufacturer	Attributes	Type 14–32	Type 40–50	Type 63-110*	
Viega Type 2	Type 2, serial number starting with 96; lateral linkage for bolt monitoring	yes	no	no	
Mannesmann "Old"	Type EFP 1; head not rotatable	yes	no	no	
Mannesmann "Old"	Type EFP 2; head rotatable	yes	no	no	
Geberit "New"	Type PWH - 75; blue sleeve over press jaw holder	yes	no	no	
Novopress	ECO 1 / ACO 1	yes	yes	no	
	ACO 201 / ACO 202 / ACO 203	yes	yes	no	
	ECO 201 / ECO 202 / ECO 203	yes	yes	no	
	AFP 201 / EFP 201	yes	yes	no	
	AFP 202 / EFP 202	yes	yes	no	
Milwaukee	Milwaukee M18 HPT	yes	yes	no	
	Milwaukee M18 BLHPT	yes	yes	no	
Ridge Tool by Arx	Ridgid RP300 Viega PT2 H	yes	no	no	
	Ridgid RP300 B Viega PT3 AH	yes	yes	no	
	Viega PT3 EH	yes	yes	no	
	Ridgid RP 10B	yes	yes	no	
	Ridgid RP 10S	yes	yes	no	
	Ridgid RP 330C Viega Pressgun 4E	yes	yes	no	
	Ridgid RP 330B Viega Pressgun 4B	yes	yes	no	
	Ridgid RP 340B/C Viega Pressgun 5B	yes	yes	no	
	Rems	REMS Akku-Press ACC (Art. No. 571004/571014)	yes	yes	no
	REMS Power-Press ACC (Art. No. 577000/577010)	yes	yes	no	
REMS ACC 22V	yes	yes	no		
Rothenberger	Romax 3000 AC	yes	no	no	

Machine type (for Uponor UP 110 & UP 75)		Uponor press jaw dimensions		
Manufacturer	Attributes	Type 14–32	Type 40–50	Type 63-110*
	Romax 4000	yes	no	no
Klauke	UAP3L / UAP2 / UNP2	yes	yes	no
Hilti	NPR 032 IE-A22 (Inline) NPR 032 PE-A22 (Pistol)	yes	yes	yes

* with modular press chains

Machine type (for Uponor Mini and Mini2)		Uponor press jaw dimensions		
Manufacturer	Attributes	Type 14–32	Type 40–50	Type 63-110*
Klauke	MAP1 / MAP2L	yes	no	no

* with modular press chains

15 General processing instructions

15.1 Installation instructions

!	Note
	Installation must be performed by a competent person in accordance with local standards and regulations.
!	Note
	Installation and operation manuals are included with the products or can be downloaded from the Uponor website: www.uponor.com .

Before installation, the installer must check all components for possible transport damage and read, understand and observe the relevant installation and operating manuals.

For the professional use of the Uponor composite pipe system, the applicable technical regulations and worksheets of the DVGW and the building regulations must also be observed. The installation must be carried out in accordance with generally recognised engineering practices. In addition, all installation, accident prevention and safety regulations must be observed.

Installation dimensions: minimum requirements

Pipe length between two fittings

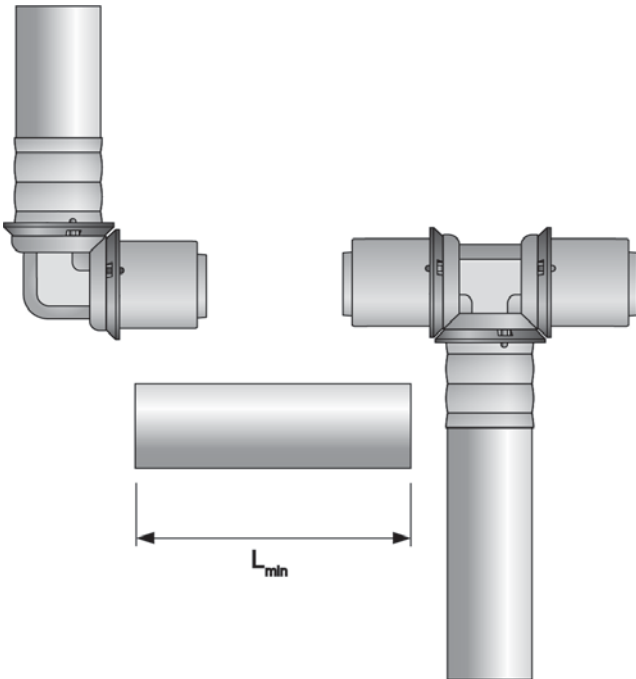

Pipe OD × s [mm]	Min. pipe length L_{min} between two	
	Press fittings [mm]	RTM fittings [mm]
14 × 2.0	50	—
16 × 2.0	50	50
20 × 2.25	55	55
25 × 2.5	70	60
32 × 3.0	70	85
40 × 4.0	100	—

Pipe OD × s [mm]	Min. pipe length L_{min} between two	
	Press fittings [mm]	RTM fittings [mm]
50 × 4.5	100	—
63 × 6.0	150	—
75 × 7.5	150	—
90 × 8.5	160	—
110 × 10.0	160	—

Minimum space requirement for hand press pliers

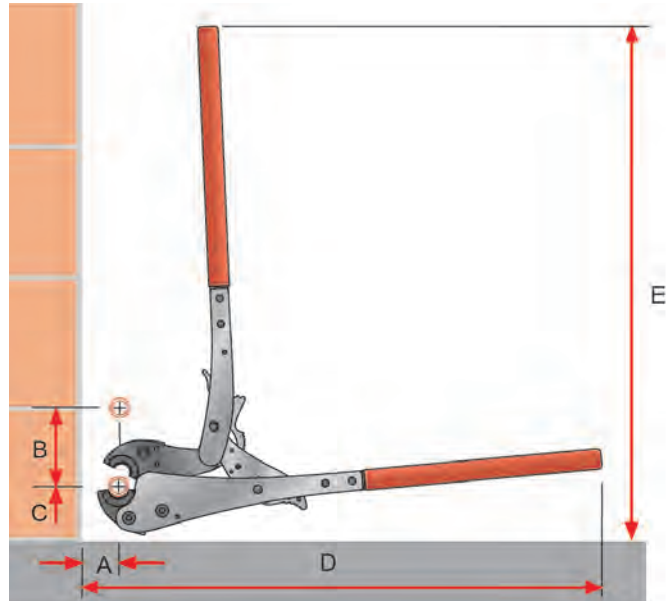

Pipe OD × s [mm]	Dim. A [mm]	Dim. B* [mm]	Dim. C [mm]	Dim. D [mm]	Dim. E [mm]
14 × 2.0	25	50	55	510	510
16 × 2.0	25	50	55	510	510
20 × 2.25	25	50	55	510	510

* For equal pipe outer diameters

Pressing process with pressing machines (UP 110, UP 75, UP 75 EL, Mini2 and Mini 32)

* For equal pipe outer diameters

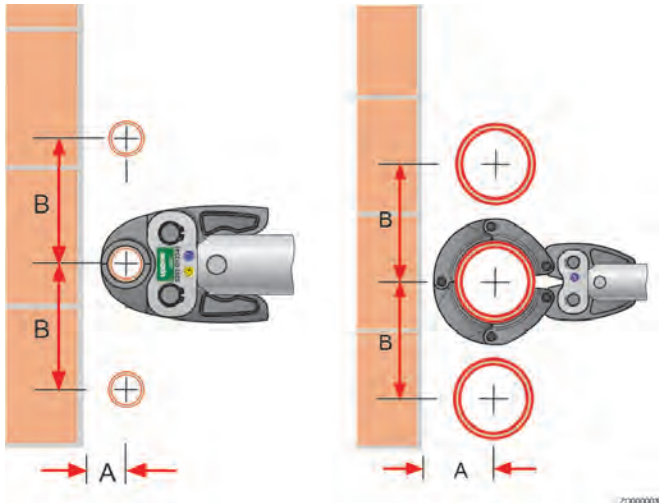

Pipe OD x s [mm]	Dim. A [mm]	Dim. B* [mm]
14 x 2.0	15	45
16 x 2.0	15	45
20 x 2.25	18	48
25 x 2.5	27	71
32 x 3.0	27	75
40 x 4.0	45	105
50 x 4.5	50	105
63 x 6.0**	80	125
75 x 7.5 **	82	130
90 x 8.5**	95	140
110 x 10.0**	105	165

* For equal pipe outer diameters

** Modular RS-System, pressing on the working bench possible

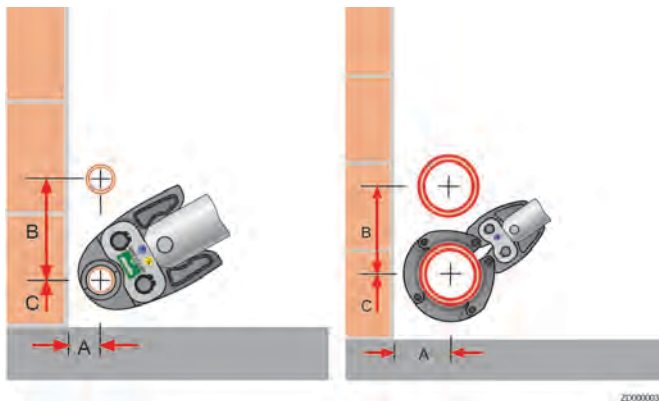

Pipe OD x s [mm]	Dim. A [mm]	Dim. B* [mm]	Dim. C [mm]
14 x 2.0	30	88	30
16 x 2.0	30	88	30
20 x 2.25	32	90	32
25 x 2.5	49	105	49
32 x 3.0	50	110	50
40 x 4.0	55	115	60
50 x 4.5	60	135	60
63 x 6.0	80	125	75
75 x 7.5	82	130	82
90 x 8.5	95	140	95
110 x 10.0	105	165	105

15.2 Installation according to Z dimension

Note
Z dimensions of the Uponor press fittings can be found in the current Uponor price list.

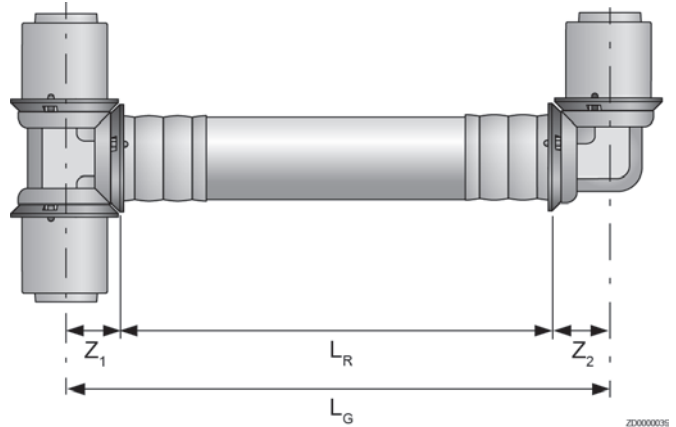

As the basis for efficient planning, work preparation and prefabrication, the Z-measurement method makes work considerably easier and saves the fabricator money.

The basis for the Z-measurement method is measuring uniformly. All the routes to be created are recorded via the axial line by measuring from centre to centre (intersection of the axial lines).

(Example: $L_R = L_G - Z_1 - Z_2$).

Using the Z-dimension data for Uponor S-Press /PLUS fittings, the installer can quickly and easily calculate the exact pipe length between fittings using a mathematical method. By precise clarification of the pipe routing and coordination with the architect, planner and construction management in the run-up to the actual installation, large parts of the system can be cost-effectively pre-assembled.

15.3 Consideration of thermal length expansion

The thermal length expansions that result from changing operating temperatures are primarily dependent on the temperature difference $\Delta\theta$ and the pipe length L.

The linear expansion of Uponor multi-layer composite pipes must be taken into account for all installation variants, particularly for freely movable pipes and cellar distribution and riser pipes, in order to avoid excessive stresses in the pipe material and damage to the connections.

The change in length can be determined using a diagram or calculated using the following formula: $\Delta L = a \times L \times \Delta\theta$

Here:

- ΔL = Linear expansion (mm)
- a = Linear expansion coefficient (0.025 mm/mK)
- L = Line length (m)
- $\Delta\theta$ = Temperature difference (K)

Length change diagram for Uponor composite pipes

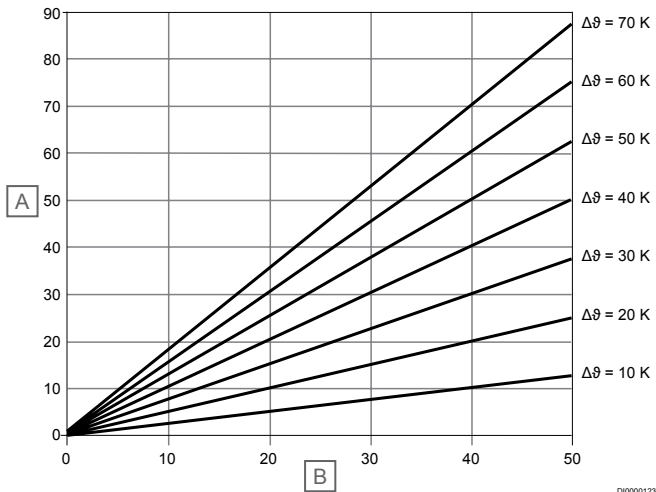

D10000123

Item	Description
A	Change in length ΔL [mm]
B	Line length L [m]

Uponor multi-layer composite pipes must not be installed rigidly between two fixed points. The change in length of the pipes must always be absorbed or guided.

Uponor multi-layer composite pipes which are exposed to full thermal expansion must be given a corresponding expansion compensation. This requires knowledge of the location of all fixed points. Compensation is always performed between two fixed points (FP) and changes in direction (bending leg).

15.4 Cellar distribution and riser pipes

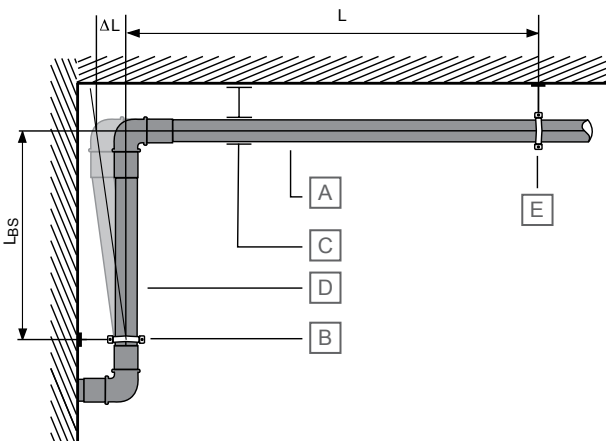

ZD0000040

Item	Description
A	Expansion leg
B	Fixed point
C	Sliding clamp
D	Bending leg
E	Fixed point
L	Length of bending leg in m
L_{BS}	Bending leg length in mm

When planning and laying cellar distribution and riser pipes with the Uponor composite pipe system, not only the structural requirements but also the thermal expansion in length must be taken into account.

15.5 Determination of the bending leg length

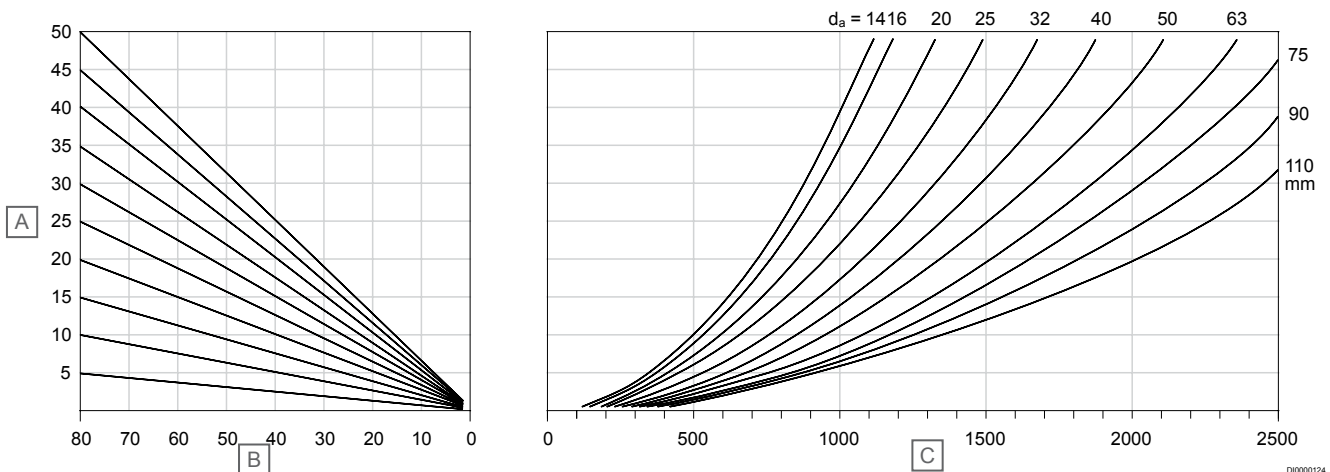

Item	Description
A	Length of expansion leg L (m)
B	Temperature difference $\Delta\theta$
C	Bending leg length L_{BS} [mm]

following table must be respected. For bending larger Uponor composite pipe dimensions, please contact Uponor. If narrower deflections than the minimum bending radius are required (e.g. at the transition from the floor to the wall), the flow-optimised Uponor bends or the Uponor 90° angle fittings should be used. If an Uponor composite pipe is inadvertently bent or otherwise damaged, it must be replaced immediately or an Uponor press or screw coupling installed.

Reading example

Description	Value
Installation temperature	20 °C
Operating temperature	60 °C
Temperature difference $\Delta\theta$	40 K
Length of bending leg	25 m
Pipe dimension OD x s	32 x 3 mm
Required bending leg length LBS	approx. 850 mm

Bending radii with/without auxiliary equipment



Caution!

Pipes routed through ceiling recesses and wall openings must never be allowed to be bent over edges!

Calculation formula:

Description	Value
L_{BS}	$k \cdot \sqrt{OD \cdot (\Delta\theta \cdot a \cdot L)}$
OD	Pipe outer diameter in mm
L	Length of bending leg in m
L_{BS}	Bending leg length in mm
a	Coefficient of linear expansion [0.025 mm/mK]
$\Delta\theta$	Temperature difference in K
k	30 (material constant)



Uponor Uni Pipe PLUS bending tool. Complete with case and bending segments 16 – 32 mm.

15.6 Bending Uponor composite pipes



Caution!

The hot bending of Uponor composite pipes using open flames (e.g. soldering flame) or other heat sources (e.g. hot air gun, industrial hairdryer) is not permitted! Repeated bending around the same bending point is also prohibited!

Uponor composite pipes 14 – 32 mm can be bent by hand, with the bending spring or bending tool. The minimum bending radii in the



Pipe OD × s [mm]	Pipe type	Min. bending radius without tools (by hand) [mm]		Min. bending radius with internal bending spring ²⁾ [mm]		Min. bending radius with external bending spring [mm]		Min. bending radius with bending tool ¹⁾ [mm]	
		Coil	Bar	Coil	Bar	Coil	Bar	Coil	Bar
14 × 2.0	Uni Pipe PLUS	70	—	56	—	56	—	46	—
16 × 2.0	Uni Pipe PLUS	64	64	48	48	48	48	32	32
20 × 2.25	Uni Pipe PLUS	80	80	60	60	60	60	40	40
25 × 2.5	Uni Pipe PLUS	125	125	75	75	75	75	62.5	62.5
32 × 3.0	Uni Pipe PLUS	160	—	96	—	—	—	80	80

1) Follow the operating instructions for the tools

2) Not recommended for hygienic reasons when using drinking water

Bending radii for Uponor composite pipes with and without auxiliary equipment

Valve and device connections as well as connections of measuring and control equipment must always be torsion-proof. All pipelines must be routed in such a way that thermal expansion (heating and cooling) is not impeded. The change in length between two fixed points can be absorbed by expansion bends, compensators or by changing the direction of the pipeline.

15.7 Fixation distances

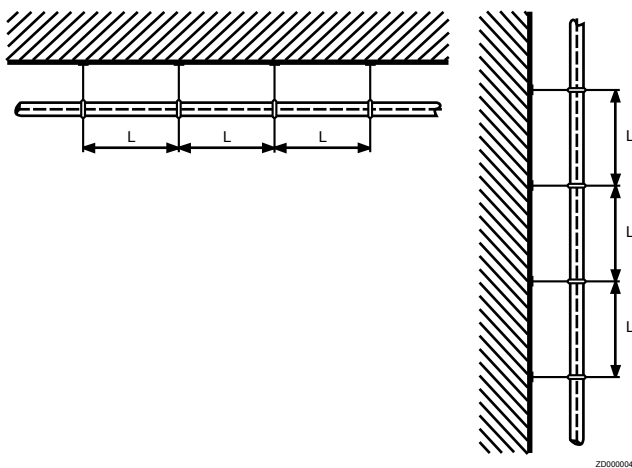

Pipe OD × s [mm]	Max. fastening distance between the pipe clamps L [m]		
	Horizontal		Vertical
	Coil	Bar	
14 × 2.0	1.20	—	1.70
16 × 2.0	1.20	2.00	2.30
20 × 2.25	1.30	2.30	2.60
25 × 2.5	1.50	2.60	3.00
32 × 3.0	1.60	2.60	3.00
40 × 4.0	—	2.00	2.20
50 × 4.5	—	2.00	2.60
63 × 6.0	—	2.20	2.85
75 × 7.5	—	2.40	3.10
90 × 8.5	—	2.40	3.10
110 × 10.0	—	2.40	3.10

If the Uponor composite pipes are laid freely on the ceiling with pipe clamps, no supporting shells need to be used. The following table shows the maximum fixing distance "L" between the individual pipe clamps for the different pipe dimensions. Type and distances for pipe fastening depend on pressure, temperature and medium. Pipe fixing points must be laid out based on the total mass (weight of pipe + weight of medium + weight of insulation) in accordance with recognised engineering practices. It is recommended to place the pipe fasteners as close as possible to the fittings.

15.8 Pipeline laying on the raw floor

When laying pipelines on a raw concrete ceiling, generally recognised engineering practices must be observed. Impact sound insulation must be installed in accordance with the DIN 4109 standard "Sound insulation in building construction". The insulation regulations according to the Energy Saving Ordinance EnEV and the technical regulations for drinking water distribution (TRWI) DIN 1988-200 must be observed. The thermal mobility of pipelines during thermal expansion must also be taken into account (see section "Thermal expansion"). If screeds are applied to insulation layers (floating screed), DIN 18560-2 "Screeds in the building industry" must be observed in particular. In DIN 18560-2: 2009-09, the following statements are made (Point 4.1 Load-bearing substrate):

- The load-bearing substrate must be sufficiently dry to accommodate the floating screed and have an even surface. Flatness and angular tolerances must comply with DIN 18202. It must not have any point elevations, pipelines or the like which could lead to acoustic bridges and/or fluctuations in the thickness of the screed.
- For heated screeds made of prefabricated elements, the manufacturer's special requirements regarding the evenness of the load-bearing substrate must also be observed.
- If pipelines are laid on the load-bearing substrate, they must be fixed. A level surface for the absorption of the insulation layer - but at least for the impact sound insulation - must be created again by means of compensation. The construction height required for this must be planned in.
- Levelling layers must have a bonded form when installed. Bulk materials may be used if their usefulness has been proven. Pressure-resistant insulating materials may be used as levelling layers.
- Waterproofing against soil moisture and non-pressing water must be determined by the building planner and must be carried out before the screed is installed (see DIN 18195-4 and DIN 18195-5).

The Uponor composite pipes and the other installations on the unfinished concrete floor should be guided in a straight line, parallel to the axis and wall and as free from crosses as possible. Preparation of an installation plan before the installation of the pipe routes and other installations will facilitate installation.

Fastening distances when laying pipelines

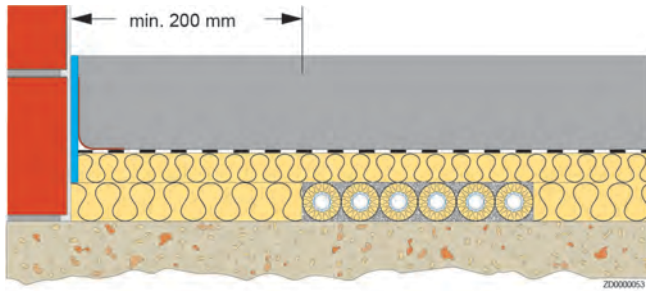

Distance from wall to pipe/pipe routes including insulation and screed in corridors

Pipe routing

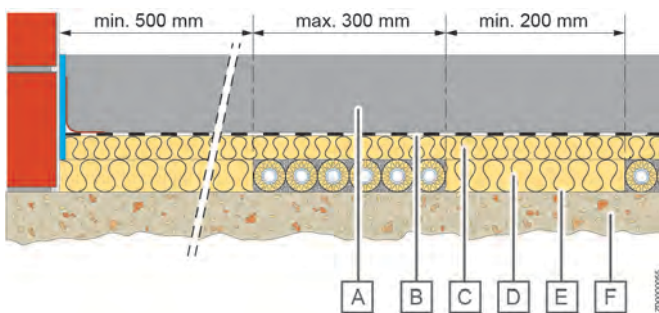
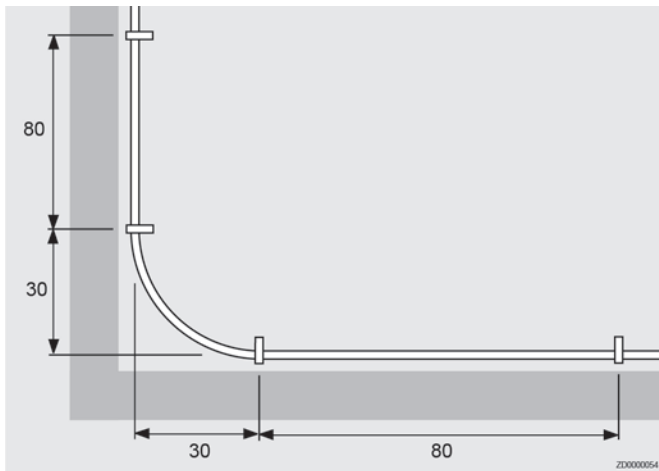

Distance from wall to pipe/pipe routes including insulation and screed in rooms other than corridors

Item	Description
A	Screed
B	Moisture barrier
C	Step sound protection
D	Levelling material
E	Bound fill
F	Unfinished concrete ceiling

Pipes and other installations in the floor structure must be planned free of crossings. Pipes on the unfinished floor should be as straight as possible and parallel to the axis and wall. The following route dimensions for pipelines and other installations should be observed:

Application	Width or distance dimension
Route width of parallel pipelines including pipe insulation	≤ 300 mm

When installing Uponor composite pipes on an unfinished concrete ceiling, a fixing distance of 80 cm is recommended. Before and after each bend a fastener must be placed at a distance of 30 cm. Pipe crossings are to be fixed. Fastening can be carried out with the plastic dowel hooks for single or double pipe fixing. If perforated tape is used for fastening, care must be taken to ensure that the Uponor multi-layer composite pipe remains freely movable with/without protective tube or insulation. If the pipe is firmly fixed, noises can occur during the thermal expansion of the pipe. If the Uponor composite pipe system is laid directly in the screed, the fittings must be protected against corrosion with suitable measures. Joints must also be arranged above construction joints in the insulation layer and in the screed (expansion joints) to prevent damage to the screed and floor coverings. Uponor multi-layer composite pipes which cross building joints must be sheathed in the joint area at least with the longitudinally slotted Uponor joint protection tube (each side of the expansion joint 20 cm).

Application	Width or distance dimension
Width of the support next to a route (with the narrowest possible pipe laying next to each other)	≥ 200 mm
Distance from wall to pipe/pipe route including insulation as support for screed in rooms other than corridors	≥ 500 mm
Distance from wall to pipe/pipe route including insulation as support for screed in corridors	≥ 200 mm

15.9 Installation under mastic asphalt



Caution!

The cold water must circulate continuously through the pipe to detect any damage when the mastic asphalt is applied.



Caution!

It must always be ensured that the Uponor composite pipe system does not come into contact with the mastic asphalt. The protective measures described must ensure that the maximum temperature on the pipe surface does not exceed 95 °C! In general, DIN 18560 "Screeds in the building industry", the specifications of the mastic asphalt manufacturer, the duty of care of the mastic asphalt applicator, DIN 4109 "Sound insulation in building construction" and recognised engineering practices apply.

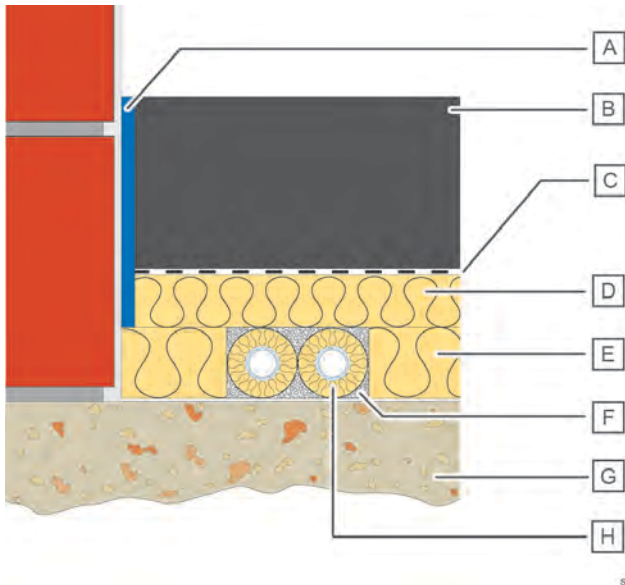

insulation must be covered with a temperature-resistant adhesive tape (e.g. aluminium adhesive tape). Alternatively, the insulation shells around the pipe can also be fixed with binding wire.

These measures protect the Uponor composite pipe system from heat radiation and from direct contact with the mastic asphalt. Parts of the line protruding from the ground must be protected from direct contact with mastic asphalt or heat radiation. After the mastic asphalt has hardened and cooled, the mineral wool in the visible area of the Uponor composite pipe or radiator connection is removed. The use of a floor rosette is recommended for a clean finish.

Floor construction with mastic asphalt

Item	Description
A	Poured asphalt-resistant edge insulation strip
B	Poured asphalt
C	Overlapped ribbed board or wool felt coarse board
D	Pour asphalt-resistant mineral sheet
E	Levelling material
F	Bound fill
G	Unfinished concrete ceiling
H	(Pre)insulated Uponor composite pipe

Mastic asphalt is brought into the room at a temperature of up to 230 °C. The composite pipe and all other temperature-sensitive plastic parts must therefore be protected. The edge insulation strip belonging to the Uponor system is not permitted for the placement of mastic asphalt. For this application there are special mineral fibre edge insulation strips suitable for asphalt, which can be procured by the customer.

The Uponor composite pipe system can be used in conjunction with mastic asphalt if the following precautions are observed.

The non-insulated Uponor composite pipe must at least be laid in a protective tube. The use of pre-insulated Uponor composite pipes is recommended in order to meet the requirements of DIN 1988 and the EnEV energy saving regulations.

The pipe system must be filled with cold water and pressurised to detect any damage when the mastic asphalt is applied.

The installation of a poured asphalt screed over Uponor pipes can be carried out in compliance with the following floor structure (from bottom to top):

- Raw concrete ceiling on which Uponor composite pipe in a protective tube or pre-insulated Uponor composite pipe is laid
- Perlite fill as levelling layer up to top edge of protective tube or pipe insulation
- Rock wool mat (suitable for mastic asphalt) with a thickness of at least 20 mm, WLG 040
- Mastic asphalt, application temperature about 230 °C

System components (pipes and fittings) which may come into contact with mastic asphalt (e.g. around the seal under a radiator) must be sheathed with 50 % insulation (at least 20 mm thick) of fire protection class A1 (non-combustible) in accordance with DIN 4102 (e.g. with Rockwool insulating shell RS 835/Conlit 150 P/U). The non-combustible insulation must completely enclose the Uponor composite pipe and the Uponor fittings. The joints of the insulation shells and the transition from heat-resistant thermal or impact sound insulation (suitable for mastic asphalt) to non-combustible pipe

16 Transport, storage and processing conditions

16.1 General information

The Uponor composite pipe system is designed in such a way that maximum system safety is achieved when used as intended. All components of the system must be transported, stored and processed in such a way that proper functioning of the installation is guaranteed. The system components should be stored in a system-related manner to avoid confusion with components from other application areas. In addition to the following instructions, the instructions in the respective assembly instructions for the individual system components and tools must also be observed.

16.2 Processing temperatures

The permissible processing temperature for the Uponor composite pipe system (pipes and fittings) is between $-10\text{ }^{\circ}\text{C}$ and $+40\text{ }^{\circ}\text{C}$. The permissible temperature ranges for the pressing tools can be found in the respective operating instructions of the devices.

16.3 Uponor composite pipes

The pipes must be protected from mechanical damage, dirt and direct sunlight (UV radiation) during transport, storage and processing. The pipes should therefore be kept in their original packaging until they are processed. This also applies to remnants intended for further use. The pipe ends must be closed until processing to prevent dirt from entering the pipes. Damaged, bent or deformed pipes must not be processed. Tubular cartons with ring bundles can be stacked up to a max. stacking height of 2 m. The bar stock must be transported and stored in such a way that it cannot bend. The corresponding Uponor storage instructions must be observed.

16.4 Uponor fittings

Uponor fittings must not be thrown or otherwise handled improperly. Fittings should be kept in their original packaging until processed to prevent damage and contamination. Damaged fittings or fittings with damaged O-rings must not be processed.

16.5 Installation in the ground and outdoors

	Caution!
	In the case of permanent exposure to moisture and a simultaneous pH value greater than 12.5, Uponor fittings must be protected with a suitable jacket (e.g. insulating tape or shrink sleeve).

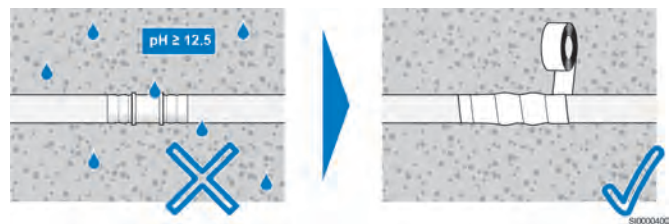

Uponor composite pipes can be laid in the ground or outdoors with the appropriate jointing technique, taking the following points into account: Pipelines laid in the ground must not be exposed to traffic loads.

- No coarse-grained, sharp-edged material may be used for backfilling the trench.
- When laying the pipes in the ground, care must be taken to ensure that the Uponor composite pipes are protected from mechanical influences.
- Fittings and thus also the cutting edges of the composite pipes must be protected from direct contact with the ground by means of suitable corrosion protection tapes.
- For outdoor use aboveground, Uponor composite pipes must be protected against increased UV radiation outdoors and against mechanical influences. This is best done using UV-protected corrugated protective tubes, which Uponor offers in various dimensions to suit.

17 System compatibility













In the history of Uponor, the composite pipe has been supplied in various variants:

- Red Unipipe F composite pipe (PE-MD/AL/PE-MD) for underfloor heating installation
- Brown Unipipe S composite pipe (PE-X/AL/PE-X) for drinking water distribution
- White Unipipe H composite pipe (PE-X/AL/PE-X) for heating installations

Since the beginning of 1997, the white Uponor MLC composite pipe (PE-RT/AL/PE-RT) has been supplied for all applications (sanitary, heating and surface heating installations).

In the event that systems with Uponor MLC composite pipes with dimensions of 16 – 32 mm are to be extended or repaired, the current Uponor S-Press/S-Press PLUS fittings can be used to switch to the current Uponor Uni Pipe PLUS composite pipe.

17.1 Transitions from Unipipe old installations

Old installation (until 1997)				Fitting designation	New installation	
Pipe designation	Application	Colour	Dimension		Pipe designation	Application
Unipipe F  CB00000421	Underfloor heating	Red	16 mm	 PH0000136 Uponor Uni-X Reno transition MLC	Uponor Uni Pipe PLUS  CB00000425	Drinking water, heating
Unipipe S  CB00000423	Potable water	Brown	16 — 20 mm	 PH0000136 Uponor Uni-X Reno transition MLC	Uponor Uni Pipe PLUS  CB00000425	Drinking water, heating
Unipipe H  CB00000424	Heating	White	16 — 20 mm	 PH0000136 Uponor Uni-X Reno transition MLC	Uni Pipe PLUS  CB00000425	Drinking water, heating
Old installation (1997 to 2020)				Fitting designation	New installation	
Pipe designation	Application	Colour	Dimension		Pipe designation	Application
Uponor MLC  CB00000424	Potable water, heating	White	14 — 32 mm	 PH0000137 S-Press PLUS, S-Press, RTM, Uni-X, Uni-C	Uni Pipe PLUS  CB00000425	Drinking water, heating

18 Calculation/assembly times

The ancillary services listed above should appear as separate items in the tender. The assembly times listed below are based on practical values from experienced Uponor users. Furthermore, calculation practices in Germany vary greatly from state to state and from region to region. As a result, the following assembly times can only be an approximate calculation basis. More detailed figures can be obtained from the relevant trade associations, which have extensive data at their disposal.

All information must be checked for correctness by the executing engineer/installer before use in business transactions. Uponor accepts no liability for the correctness of the information values and for any consequential damage which may arise and/or may arise as a result of incorrect guideline values, unless the values were specified by Uponor or its vicarious agents with gross negligence or willful misconduct.

The assembly times include the performance of two persons and are specified in group minutes.

The task of costing is to determine the costs of construction services in order to prepare a quotation. This is based on a list of services which describes the construction work to be carried out in detail. The general conditions for the calculation can be found in the current VOB Part C (DIN 18381).

The assembly times in the table below include the following work:

- Ready tools and aids at the construction site
- Read plans
- Calibrate pipe routing
- Measuring, marking, cutting to length, deburring and cleaning pipes
- Assemble pipes, including Fastening
- Pressing

The following ancillary services are not included in these assembly times:

- Preparation of assembly plans
- Setting up and clearing the construction site
- Day labour
- Insulation work
- Pressure test
- Construction inspection
- Creating the measurement

18.1 Assembly time per running meter or fitting

Assembly time in group minutes (2 fitters) per running meter or fitting.

Pipe OD × s [mm]	Pipe in protective tube	Pre-insulated pipe	Pipe as bar	Fitting connections	Angles, couplings, reductions	T-joints	Threaded connections
14 × 2.0	3.0	3.0	—	3.5	1.0	1.5	1.5
16 × 2.0	3.0	3.0	5.5	3.5	1.0	1.5	1.5
20 × 2.25	3.5	3.5	6.0	3.5	1.0	1.5	2.0
25 × 2.5	5.0	—	7.0	—	1.5	2.0	2.0
32 × 3.0	6.0	—	8.5	—	2.0	2.5	2.0
40 × 4.0	—	—	8.5	—	3.0	3.5	2.5
50 × 4.5	—	—	10.0	—	3.5	4.0	3.0
63 × 6.0	—	—	12.0	—	—	—	—
75 × 7.5	—	—	12.0	—	—	—	—
90 × 8.5	—	—	13.0	—	—	—	—
110 × 10	—	—	13.0	—	—	—	—

18.2 Assembly time per modular Uponor RS fitting



Assembly time in group minutes (2 fitters) per modular Uponor RS fitting.

Base body dimension	Press adapter	Thread adapter	T-piece	Elbow/coupling
RS 2	1.5	2.5	1.0	0.5
RS 3	1.5	3.0	1.0	5

Source: Survey of Uponor manufacturing companies

19 Risk of mixed installation

Note
Uponor Declaration of Warranty:
 To get the registration form, please contact the local Uponor unit.

Note
 Components from the different Uponor systems may only be mixed with one another if Uponor expressly indicates this option.









Opinions and interpretations vary relating to mixed installations and different information exists in the marketplace regarding unrestricted compatibility with our products, so, as a precautionary measure, the company states the following: the company offers no guarantee regarding the compatibility of the relevant third party products with our products.

Documentation available to Uponor from dealers/third-party manufacturers state that it is not apparent that the compatibility claimed by them is covered by a full warranty.

In cases of mixed installations, the 10-year Uponor Declaration of Warranty will not generally be issued for Uponor components. The legal warranty period will still apply.

19.1 Installation configurations

Note
 In a mixed installation, the warranty provided by the pipe manufacturer only covers the pipe while the warranty provided by the fitting manufacturer only covers the fitting. Neither warranty covers the connection point nor do they cover the system in its entirety. This responsibility is borne solely by the installer.

Pipe		Fittings and tools		Manufacturer's system approval
 RP0000222	+	 RP0000223	=	 Yes
 RP0000222	+	 RP0000224	=	 No
 RP0000226	+	 RP0000227	=	 No

Uponor

Uponor Corporation

Äyritie 20
01510 Vantaa, Finland

1119966 v1_12_2020_EN
Production: Uponor/ELO/ALO

Uponor reserves the right to make changes, without prior notification, to the specification of incorporated components in line with its policy of continuous improvement and development.



www.uponor.com