



ENVIRONMENTAL PRODUCT DECLARATION

In accordance with ISO 14025 for

Mapequick AF D03
Mapequick AF-118N



Programme:
**The International
EPD[®] System;**
www.environdec.com

Programme
operator:
EPD International AB

EPD registration
number:
S-P-01577

Publication
date:
2020-03-12

Valid until:
2025-03-11

Geographical
scope:
International

Revision:
2020-08-04





1. COMPANY DESCRIPTION / GOAL & SCOPE

Founded in 1937 in Milan, Italy, Mapei produces adhesives and complementary products for laying all types of floor, wall and coating materials, and also specializes in other chemical products used in the building industry, such as waterproofing products, specialty mortars, admixtures for concrete, products for underground constructions and for the restoration of concrete and historical buildings.

There are currently 90 subsidiaries in the Mapei Group, with a total of 83 production facilities located around the world in 36 different countries and in 5 different continents. Mapei also has 31 central laboratories. Most locations are ISO 9001 and ISO 14001 or EMAS-certified.

Mapei's strategy of internationalization is based on two main objectives: being closer to local needs and lowering transportation costs. With the declared objective of being close to buyers and clients, Mapei's presence in the five continents enables the company to comply with the requirements of each location, and to use only locally-based managers and qualified personnel, without changing the approach of Mapei.

Mapei invests 12% in its company's total work-force and 5% of its turnover in Research & Development; in particular, 70% of its R&D efforts are directed to develop eco-sustainable and environmentally friendly products, which give important contribution to all major green rating systems for eco-sustainable buildings such as LEED and BREEAM.

Furthermore, Mapei has developed a sales and technical service network with offices all over the world and offers an efficient Technical Assistance Service that is valued by architects, engineers, contractors and owners.

Mapei Nordic production site is located in Sagstua, Norway. The production site consists of 5 factories: two factories for powder-based products, two factories for liquid admixtures and one factory for thermosetting plastic-based products.

The total size of the buildings is 24.000 sqm. The energy in these factories are provided from water electricity, geothermal heating and remaining approximately 10 % heated by bio oil.

Mapei Nordic focuses both on energy and on logistic optimisation, as for example the systematic Lean based improvement work. With 60 – 80 trailers per day, and 1650 transport lines, requires Mapei to work actively on optimizing our logistic process.

The goal of the study is to provide necessary data and documentation to produce an EPD according to the requirements of PCR Environdec (version 2.31, 2019-12-20) under EN 15804:2014 and to have more

comprehension about the environmental impacts related to **Mapequick AF D03** and **Mapequick AF-118N** manufactured in Mapei AS located in Sagstua (Norway), including packaging of the finished products.

Target audiences of the study are customers and other parties with an interest in the environmental impacts of **Mapequick AF D03** and **Mapequick AF-118N**.

This analysis shall not support comparative assertions intended to be disclosed to the public.

2. PRODUCT DESCRIPTION

Mapequick AF D03 is an alkali-free accelerator for sprayed concrete. It is first of all suitable for use with wet application but can also be used for dry application systems.

Mapequick AF-118N is a liquid alkali-free accelerator developed for mortars and shotcrete. The product is especially developed for the Nordic and Baltic conditions.

The two products are supplied in IBC or bulk.

Mapequick AF D03
Mapequick AF-118N



3. CONTENT DECLARATION

The main components and ancillary materials of **Mapequick AF D03** and **Mapequick AF-118N** are the following:

Table 1: Composition

Materials	Percentage (%)
Inorganic substances	< 85
Organic substances	< 11
Water	< 40
Packaging	< 2

The products contain neither carcinogenic substances nor substances of very high concern (SVHC) on the REACH Candidate List published by the European Chemicals Agency, in a concentration higher than 0,1 % (by unit weight).

4. DECLARED UNIT AND REFERENCE SERVICE LIFE

The declared unit is 1 kg of product included packaging.

Packaging materials are:

- Wooden pallet
- LDPE used as wrapping material
- IBC tank

Due to the selected system boundary, the reference service life of the products is not specified.

5. SYSTEM BOUNDARIES AND ADDITIONAL TECHNICAL INFORMATION

The approach is “cradle to gate”.

The following modules have been considered:

- A1 – A3 (Product stage): extraction and transport of raw materials, packaging included, production process

Table 2: System boundaries

System Boundaries														
A1 – A3			A4 – A5		B1 – B7					C1 – C4				D
PRODUCT STAGE			CONSTRUCTION PROCESS STAGE		USE STAGE					END OF LIFE STAGE				
A1	A2	A3	A4	A5	B1	B2	B3	B4	B5	C1	C2	C3	C4	
Raw Material Supply	Transport	Manufacturing	Transport	Installation Process	Use	Maintenance	Repair	Replacement	Refurbishment	Deconstruction/ Demolition	Transport	Waste Processing	Disposal	
					B6	Operational Energy Use								
					B7	Operational Water Use								

included
 excluded

A brief description of production process, is the following:

The production process starts from raw materials, that are purchased from external and intercompany suppliers and stored in the plant. Bulk raw materials are stored in specific silos and added automatically in the production mixer, according to the formula of the product. Other raw materials, supplied in bags, big bags or plastic 1000 lt IBC, are stored in their warehouse and added automatically or manually in the mixer. The production is a discontinuous process, in which all the components are mechanically mixed in batches. The semi-finished product is then packaged in plastic 1000 lt IBC or managed in bulk. The quality of final products is controlled before the sale.

Mapequick AF D03
Mapequick AF-T18N



Figure 1: Production process

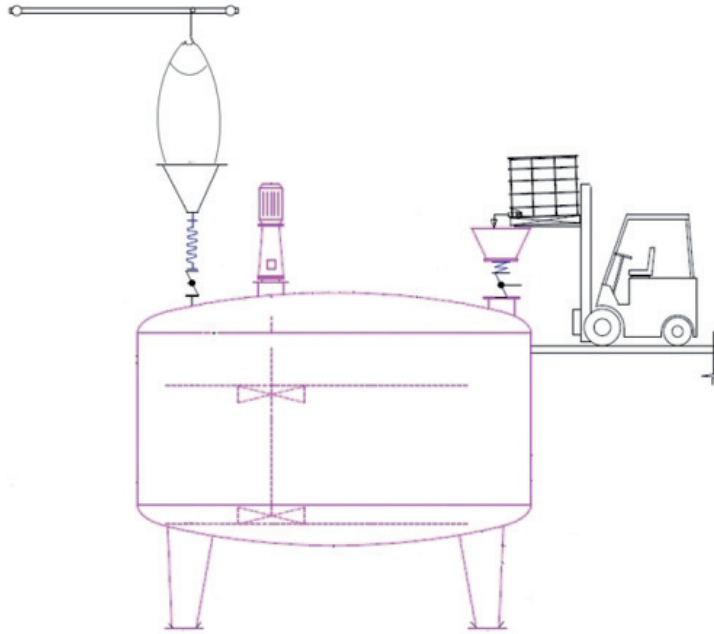

Figure 2: Sagstua Plant



6. CUT-OFF RULES AND ALLOCATION

Criteria for the exclusion of inputs and outputs (cut-off rules) in the LCA, information modules and any additional information are intended to support an efficient calculation procedure. They are not applied in order to hide data.

The procedure of exclusion of inputs and outputs is the following:

- All inputs and outputs to a unit process, for which data are available, are included in the calculation
- Cut-off criteria, where applied, are described in Table 3

Input flows are covered for the whole formula.

Table 3: Cut-off criteria

Process excluded from study	Cut-off criteria	Quantified contribution from process
A3: waste and particle emission	less than 10^{-5} kg/kg of finished product	Sensibility study demonstrates a contribute lower than 0,5%

For the allocation procedure and principles, consider the table 4.

Table 4: Allocation procedure and principles

Module	Allocation Principle
A1	All data are referred to 1 kg of product <ul style="list-style-type: none"> • A1: electricity is allocated to the specific production line
A3	All data are referred to 1 kg of packaged product: <ul style="list-style-type: none"> • A3-wastes: all data are allocated to the specific production line

Mapequick AF D03
Mapequick AF-T18N



7. ENVIRONMENTAL PERFORMANCE AND INTERPRETATION



GWP₁₀₀

Global Warming Potential refers to the emission/presence of GHGs (greenhouse gases) in the atmosphere (mainly CO₂, N₂O, CH₄) which contribute to the increase in the temperature of the planet.



AP

Acidification Potential refers to the emission of specific acidifying substances (i.e. NO_x, SO_x) in the air. These substances decrease the pH of the rainfall with predictable damages to the ecosystem.



EP

Eutrophication Potential refers to the nutrient enrichment of flowing water, which determines unbalance in aquatic ecosystems and causes the death of the aquatic fauna.



ODP

Ozone Depletion Potential refers to the degradation of the stratospheric layer of the ozone involved in blocking the UV component of sunrays. Depletion is due to particularly reactive components that originate from chlorofluorocarbon (CFC) or chlorofluoromethanes (CFM).



POCP

The Photochemical Ozone Creation Potential is the ozone formation in low atmosphere. This is quite common in the cities where a great amount of pollutants (like VOC and NO_x) are emitted every day (industrial emissions and vehicles). It is mainly diffused during the summertime.



ADP_e (elements)

Abiotic Depletion Potential elements refers to the depletion of the mineral resources.



ADP_f (fossil fuel)



Abiotic Depletion Potential fossil fuel refers to the depletion of the fossil fuel resources.

Following tables show environmental impacts for the products considered according to CML methodology (2001 – Jan. 2016 ver. 4.7). All the results are referred to the declared unit (see § 4).

Mapequick AF D03

(packaged in IBC tank)

Table 5: **Mapequick AF D03**: Environmental categories referred to 1 kg of product packaging included

Environmental Category	Unit	A1 – A3
 GWP₁₀₀	(kg CO ₂ eq.)	5,21E-01
 ADPe (element)	(kg Sb eq.)	3,34E-06
 ADPf (fossil)	(MJ)	9,84E+00
 AP	(kg SO ₂ eq.)	4,61E-03
 EP	(kg (PO ₄) ³⁻ eq.)	1,49E-03
 ODP	(kg R-11 eq.)	7,64E-08
 POCP	(kg ethylene eq.)	2,65E-04

GWP₁₀₀: Global Warming Potential; **ADPe**: Abiotic Depletion Potential (elements); **EP**: Eutrophication Potential; **AP**: Acidification Potential; **POCP**: Photochemical Ozone Creation Potential; **ODP**: Ozone Depletion Potential; **ADPf**: Abiotic Depletion Potential (fossil)

Mapequick AF D03
Mapequick AF-T18N



Table 6: **Mapequick AF D03**: Other environmental indicators referred to 1 kg of product packaging included

Environmental Indicator	Unit	A1-A3
RPEE	MJ	1,00E+00
RPEM	MJ	-
TPE	MJ	1,00E+00
NRPE	MJ	1,16E+01
NRPM	MJ	-
TRPE	MJ	1,16E+01
SM	kg	-
RSF	MJ	-
NRSF	MJ	-
W	m ³	2,14E-02

RPEE Renewable primary energy as energy carrier; **RPEM** Renewable primary energy as material utilisation; **TPE** Total use of renewable primary energy sources; **NRPE** Non-renewable primary energy as energy carrier; **NRPM** Non-renewable primary energy as material utilization; **TRPE** Total use of non-renewable primary energy sources; **SM** Use of secondary materials; **RSF** Renewable secondary fuels; **NRSF** Non-renewable secondary fuels; **W** Net use of fresh water







Table 7: **Mapequick AF D03**: Waste production & other output flows referred to 1 kg of product packaging included

Output flow	Unit	A1-A3
NHW	kg	2,74E-04
HW	kg	1,39E-06
RW	kg	8,81E-06
Components for re-use	kg	-
Materials for recycling	kg	1,66E-03
Materials for energy recovery	kg	1,49E-03
Exported energy	MJ	-

HW Hazardous waste disposed; **NHW** Non Hazardous waste disposed; **RW** Radioactive waste disposed

Mapequick AF D03 (bulk)

Table 8: **Mapequick AF D03**: Environmental categories referred to 1 kg of product (bulk)

Environmental Category	Unit	A1 – A3
 GWP₁₀₀	(kg CO ₂ eq.)	5,08E-01
 ADPe (element)	(kg Sb eq.)	3,34E-06
 ADPf (fossil)	(MJ)	9,57E+00
 AP	(kg SO ₂ eq.)	4,56E-03
 EP	(kg (PO ₄) ³⁻ eq.)	1,48E-03
 ODP	(kg R-11 eq.)	7,64E-08
 POCP	(kg ethylene eq.)	2,60E-04

GWP₁₀₀: Global Warming Potential; **ADPe**: Abiotic Depletion Potential (elements); **EP**: Eutrophication Potential; **AP**: Acidification Potential; **POCP**: Photochemical Ozone Creation Potential; **ODP**: Ozone Depletion Potential; **ADPf**: Abiotic Depletion Potential (fossil)

Mapequick AF D03
Mapequick AF-T18N



Table 9: **Mapequick AF D03**: Other environmental indicators referred to 1 kg of product (bulk)

Environmental Indicator	Unit	A1-A3
RPEE	MJ	9,24E-01
RPEM	MJ	-
TPE	MJ	9,24E-01
NRPE	MJ	1,13E+01
NRPM	MJ	-
TRPE	MJ	1,13E+01
SM	kg	-
RSF	MJ	-
NRSF	MJ	-
W	m ³	2,12E-02

RPEE Renewable primary energy as energy carrier; **RPEM** Renewable primary energy as material utilisation; **TPE** Total use of renewable primary energy sources; **NRPE** Non-renewable primary energy as energy carrier; **NRPM** Non-renewable primary energy as material utilization; **TRPE** Total use of non-renewable primary energy sources; **SM** Use of secondary materials; **RSF** Renewable secondary fuels; **NRSF** Non-renewable secondary fuels; **W** Net use of fresh water

Table 10: **Mapequick AF D03**: Waste production & other output flows referred to 1 kg of product (bulk)





Output flow	Unit	A1-A3
NHW	kg	2,75E-04
HW	kg	1,39E-06
RW	kg	8,81E-06
Components for re-use	kg	-
Materials for recycling	kg	1,71E-03
Materials for energy recovery	kg	1,54E-03
Exported energy	MJ	-

HW Hazardous waste disposed; **NHW** Non Hazardous waste disposed; **RW** Radioactive waste disposed

Mapequick AF-118N

(packaged in IBC tank)

Table 11: **Mapequick AF-118N**: Environmental categories referred to 1 kg of product packaging included

Environmental Category	Unit	A1 – A3
 GWP₁₀₀	(kg CO ₂ eq.)	7,57E-01
 ADPe (element)	(kg Sb eq.)	6,69E-06
 ADPf (fossil)	(MJ)	1,32E+01
 AP	(kg SO ₂ eq.)	7,57E-03
 EP	(kg (PO ₄) ³⁻ eq.)	2,58E-03
 ODP	(kg R-11 eq.)	9,78E-08
 POCP	(kg ethylene eq.)	4,09E-04

GWP₁₀₀: Global Warming Potential; **ADPe**: Abiotic Depletion Potential (elements); **EP**: Eutrophication Potential; **AP**: Acidification Potential; **POCP**: Photochemical Ozone Creation Potential; **ODP**: Ozone Depletion Potential; **ADPf**: Abiotic Depletion Potential (fossil)

Mapequick AF D03
Mapequick AF-118N



Table 12: **Mapequick AF-118N**: Other environmental indicators referred to 1 kg of product packaging included

Environmental Indicator	Unit	A1-A3
RPEE	MJ	1,29E+00
RPEM	MJ	-
TPE	MJ	1,29E+00
NRPE	MJ	1,57E+01
NRPM	MJ	-
TRPE	MJ	1,57E+01
SM	kg	-
RSF	MJ	-
NRSF	MJ	-
W	m ³	1,89E-02

RPEE Renewable primary energy as energy carrier; **RPEM** Renewable primary energy as material utilisation; **TPE** Total use of renewable primary energy sources; **NRPE** Non-renewable primary energy as energy carrier; **NRPM** Non-renewable primary energy as material utilization; **TRPE** Total use of non-renewable primary energy sources; **SM** Use of secondary materials; **RSF** Renewable secondary fuels; **NRSF** Non-renewable secondary fuels; **W** Net use of fresh water

Table 13: **Mapequick AF-118N**: Waste production & other output flows referred to 1 kg of product packaging included







Output flow	Unit	A1-A3
NHW	kg	3,16E-04
HW	kg	1,39E-06
RW	kg	9,67E-06
Components for re-use	kg	-
Materials for recycling	kg	1,71E-03
Materials for energy recovery	kg	1,54E-03
Exported energy	MJ	-

HW Hazardous waste disposed; **NHW** Non Hazardous waste disposed; **RW** Radioactive waste disposed

Mapequick AF-118N

(bulk)

Table 14: **Mapequick AF-118N**: Environmental categories referred to 1 kg of product (bulk)

Environmental Category	Unit	A1 – A3
 GWP₁₀₀	(kg CO ₂ eq.)	7,43E-01
 ADPe (element)	(kg Sb eq.)	6,69E-06
 ADPf (fossil)	(MJ)	1,29E+01
 AP	(kg SO ₂ eq.)	7,53E-03
 EP	(kg (PO ₄) ³⁻ eq.)	2,58E-03
 ODP	(kg R-11 eq.)	9,78E-08
 POCP	(kg ethylene eq.)	4,05E-04

GWP₁₀₀: Global Warming Potential; **ADPe**: Abiotic Depletion Potential (elements); **EP**: Eutrophication Potential; **AP**: Acidification Potential; **POCP**: Photochemical Ozone Creation Potential; **ODP**: Ozone Depletion Potential; **ADPf**: Abiotic Depletion Potential (fossil)

Mapequick AF D03
Mapequick AF-118N



Table 15: **Mapequick AF-118N**: Other environmental indicators referred to 1 kg of product (bulk)

Environmental Indicator	Unit	A1-A3
RPEE	MJ	1,21E+00
RPEM	MJ	-
TPE	MJ	1,21E+00
NRPE	MJ	1,54E+01
NRPM	MJ	-
TRPE	MJ	1,54E+01
SM	kg	-
RSF	MJ	-
NRSF	MJ	-
W	m ³	1,87E-02

RPEE Renewable primary energy as energy carrier; **RPEM** Renewable primary energy as material utilisation;
TPE Total use of renewable primary energy sources; **NRPE** Non-renewable primary energy as energy carrier;
NRPM Non-renewable primary energy as material utilization; **TRPE** Total use of non-renewable primary energy sources;
SM Use of secondary materials; **RSF** Renewable secondary fuels; **NRSF** Non-renewable secondary fuels;
W Net use of fresh water

Table 16: **Mapequick AF-118N**: Waste production & other output flows referred to 1 kg of product (bulk)

Output flow	Unit	A1-A3
NHW	kg	2,52E-04
HW	kg	4,14E-07
RW	kg	4,46E-06
Components for re-use	kg	-
Materials for recycling	kg	1,72E-03
Materials for energy recovery	kg	1,55E-03
Exported energy	MJ	-

HW Hazardous waste disposed; **NHW** Non Hazardous waste disposed; **RW** Radioactive waste disposed

Tables from 5 to 16 show absolute results for all the environmental categories considered. For both, **Mapequick AF D03** and **Mapequick AF-118N**, the **module A1** (raw materials extraction and processing) represents the highest contribution for all environmental indicators.

The following tables show the percentage contribution of the modules considered in the system boundary to the environmental impacts.

Table 17: Environmental Impact as percentage – Mapequick AF D03 and Mapequick AF-118 N (in IBC)

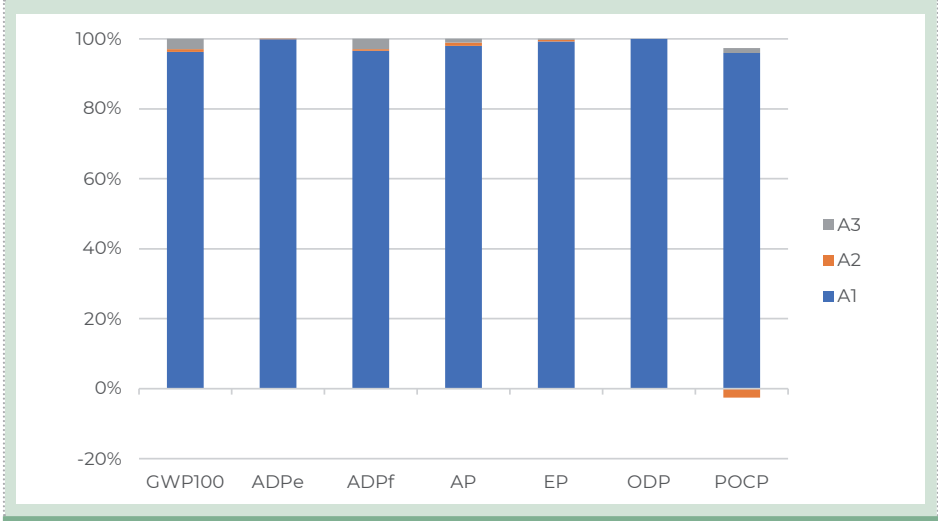
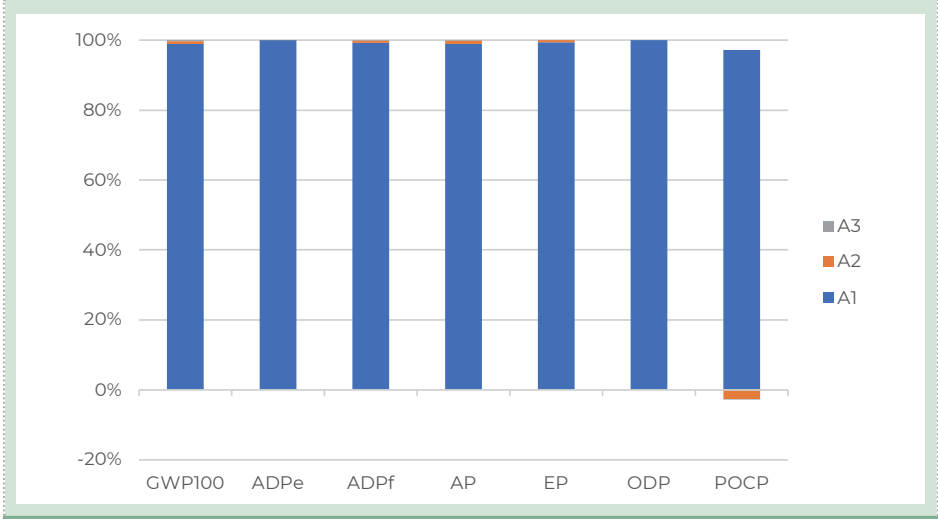

Table 18: Environmental Impact as percentage – Mapequick AF D03 and Mapequick AF-118 N (bulk)



Mapequick AF D03
Mapequick AF-118N



More details about electrical mix used in this EPD, is shown below:

	Data source	Amount	Unit
Electricity grid mix (NO) – 2016	Sphera database	0,0304	kg CO ₂ -eq/kWh

8. DATA QUALITY

Table 19: Data quality

Dataset & Geographical reference	Database (source)	Temporary reference
A1-A3		
Organic components (EU)	Sphera Database; Ecoinvent 3.5	2010 - 2019
Inorganic components (EU)	Sphera Database; Ecoinvent 3.5	2018 - 2019
Electricity grid mix (NO)	Sphera Database	2016
Packaging components (EU)	Sphera Database; PlasticsEurope	2005 – 2019
A2		
Truck transport (euro 5, 27-ton payload – GLO)	Sphera Database	2019
Light Train (Gross Ton Weight 500t – GLO)	Sphera Database	2019
Oceanic ship (27500 DWT – GLO)	Sphera Database	2019
Diesel for transport (EU)	Sphera Database	2016
Electricity grid mix (EU)	Sphera Database	2016
Heavy Fuel Oil (EU)	Sphera Database	2016

All data included in table above refer to a period between 2005 and 2019; the most relevant ones are specific from supplier, while the others (i.e. transport and minor contribution dataset), come from European and global databases.

All dataset are not more than 10 years old according to EN 15804 § 6.3.7 “Data quality requirements”. The only exception is represented by one raw material used for one packaging component production, coming from PlasticsEurope database.

Primary data concern the year 2019 and represent the whole annual production.

9. VERIFICATION AND REGISTRATION

EPD of construction products may not be comparable if they do not comply with EN 15804.

Environmental product declarations within the same product category from different programs may not be comparable.

CEN standard EN15804 served as the core PCR	
PCR:	PCR 2012:01 Construction products and Construction services, Version 2.31, 2019-12-20
PCR review was conducted by:	The Technical Committee of the International EPD® System. Chair: Filippo Sessa Contact via info@environdec.com
Independent verification of the declaration and data, according to ISO 14025	<input checked="" type="checkbox"/> EPD Process Certification (Internal) <input type="checkbox"/> EPD Verification (external)
Third party verifier:	Certiquality S.r.l. Number of accreditation: 003H rev15
Accredited or approved by:	Accredia
Procedure for follow-up of data during EPD validity involves third-party verifier	<input checked="" type="checkbox"/> Yes <input type="checkbox"/> No

Mapequick AF D03
Mapequick AF-T18N



12. REFERENCES

- HBEFA - HANDBOOK EMISSION FACTORS FOR ROAD TRANSPORT
- ISO 14025 ENVIRONMENTAL LABELS AND DECLARATIONS - TYPE III ENVIRONMENTAL DECLARATIONS - PRINCIPLES AND PROCEDURES
- ISO 14044 ENVIRONMENTAL MANAGEMENT – LIFE CYCLE ASSESSMENT – REQUIREMENTS AND GUIDELINES
- EN 15804: SUSTAINABILITY OF CONSTRUCTION WORKS - ENVIRONMENTAL PRODUCT DECLARATIONS - CORE RULES FOR THE PRODUCT CATEGORY OF CONSTRUCTION PRODUCTS
- GENERAL PROGRAMME INSTRUCTIONS OF THE INTERNATIONAL EPD® SYSTEM. VERSION 3.01
- PCR 2012:01; "PRODUCT GROUP CLASSIFICATION: MULTIPLE UN CPC CODES CONSTRUCTION PRODUCTS AND CONSTRUCTION SERVICES"; VERSION 2.31

CONTACT INFORMATION

EPD owner:	 ADHESIVES • SEALANTS • CHEMICAL PRODUCTS FOR BUILDING Mapei AS www.mapei.com/NO-NO/
LCA author:	 ADHESIVES • SEALANTS • CHEMICAL PRODUCTS FOR BUILDING Mapei SpA www.mapei.it ; Environmental Sustainability Office
Programme operator:	 EPD International AB info@environdec.com

Mapequick AF D03
Mapequick AF-T18N

SEDE

MAPEI SpA

Via Cafiero, 22 - 20158 Milano

Tel. +39-02-37673.1

Fax +39-02-37673.214

Internet: www.mapei.com

E-mail: mapei@mapei.it



ANNEX 1

ANNEX 1: Self declaration from EPD owner

Specific Norwegian requirements

1 Applied electricity data set used in the manufacturing phase

The electricity mix for the electricity used in manufacturing (A3) is the electricity grid mix

<0,0287 kg CO₂ eqv/kWh>

2 Content of dangerous substances

- The product contains no substances given by the REACH Candidate list or the Norwegian priority list.
- The product contains substances that are less than 0.1% by weight given by the REACH Candidate or the Norwegian priority list.
- The product contains dangerous substances more than 0.1% by weight given in the REACH candidate list or the [Norwegian Priority List](#), concentrations is given in the EPD:

Dangerous substances from the REACH candidate list or the Norwegian Priority List	CAS No.	Quantity (concentration, wt%/FU(DU)).
Substance 1		
Substance n		

3 Transport from the place of manufacture to a central warehouse

Transport distance, and CO₂-eqv./DU from transport of the product from factory gate to central warehouse in Oslo shall be given. The following table shall be included in the EPD:

Type	Capacity utilisation (incl. return) %	Type of vehicle	Distance km	Fuel/Energy use	Unit	Value (l/t)	Kg CO ₂ -eqv./DU
Boat							
Truck	85	27 tonn, EURO 3	95	0,0182	l/tkm	4,56	1,37E-02
Railway							
Rail							
Air							
Total	85	27 tonn, EURO 3	95	0,0182	l/tkm	4,56	1,37E-02

4 Impact on the indoor environment

- Indoor air emission testing has been performed; specify test method and reference:
- No test has being performed
- Not relevant; specify : the product is a waterproofing membranes for underground structures. It does not affect the indoor air quality.
