

Uponor PEX piping systems

EN Technical information



Table of contents

1	Material, conduits and pipe marking.....	3	6	Installation and operation.....	23
1.1	Uponor PEX, cross-linked polyethylene.....	3	6.1	Installation process.....	23
1.2	Pipe marking.....	3	6.2	Pressure and tightness testing.....	23
1.3	Coated pipes.....	4	6.3	Forces of expansion and contraction.....	23
1.4	Conduits.....	4	6.4	Shrinking.....	23
1.5	Insulation.....	4	6.5	Bending radius.....	23
1.6	Approved pipes and conduits.....	4	6.6	Kinked pipes.....	24
1.7	Packaging.....	4	7	Technical data.....	25
2	Material and pipe properties.....	5	7.1	Technical specifications.....	25
2.1	Hygienic and non-toxicological.....	5	7.2	Service conditions and design pressure.....	25
2.2	Long-term stability.....	5	7.3	Linear expansion diagram.....	26
2.3	Thermal memory.....	5	7.4	Heat emission loss diagrams.....	27
2.4	Temperature resistance.....	5	7.5	Pressure drop nomogram	28
2.5	Low friction.....	5			
2.6	Resistance of abrasion.....	5			
2.7	Chemical resistance.....	5			
2.8	Scratch resistant.....	5			
2.9	Sound absorbing.....	5			
2.10	Vibration absorbing.....	5			
2.11	Electrical insulation.....	5			
2.12	Low environmental impact.....	5			
2.13	UV light.....	5			
3	Pipe descriptions.....	6			
3.1	Uponor Aqua Pipe.....	6			
3.2	Uponor Combi Pipe.....	7			
3.3	Uponor Radi Pipe.....	8			
3.4	Uponor Teck conduits.....	9			
3.5	Uponor Comfort Pipe PLUS.....	9			
3.6	Uponor Klett Comfort Pipe PLUS.....	10			
3.7	Uponor Minitec Comfort Pipe.....	10			
3.8	Uponor Meltaway PEX Pipe.....	11			
3.9	Uponor Meltaway PLUS PE-Xa orange.....	12			
4	Component descriptions.....	13			
4.1	Uponor Q&E fittings.....	13			
4.2	Uponor Wipex fittings.....	14			
4.3	Compression fittings.....	14			
4.4	Manifolds.....	14			
4.5	Cabinets.....	16			
4.6	Pre-fabricated units.....	17			
5	Application descriptions.....	18			
5.1	Tap water.....	18			
5.2	Radiator heating.....	19			
5.3	Underfloor heating.....	20			
5.4	Surface heating.....	21			
5.5	Industrial applications.....	22			

1 Material, conduits and pipe marking



1.1 Uponor PEX, cross-linked polyethylene

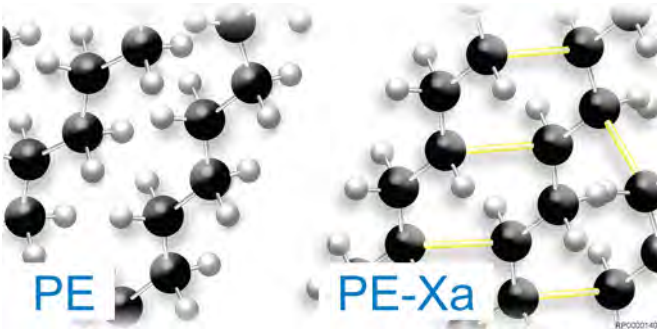

The basic Uponor PEX pipe is made from a high-density polyethylene (HDPE) with an extremely high molecular weight. At high pressure and temperature, chemical bonds – a network of cross-links – are formed between the polyethylene's long molecular chains (the Engel process). The three-dimensional network that this creates, improves the properties of the raw material to such an extent that it is transformed into a completely new material with superior characteristics.

The difference between normal polyethylene and cross-linked polyethylene (or PE-X) is analogous to that between over cooked spaghetti and fishing net. In the first case, the molecular chains are loosely arranged while, in the second, the chains are joined or cross-linked.

The Uponor PEX pipe and its further developed pipes are suitable for cold and hot water installations and heating applications. Uponor PEX pipes without a diffusion barrier must, however, not be installed for distribution of water in heating systems.

1.2 Pipe marking



Note

Always check that the correct type of pipe is used for the installation.



RP0000111

Uponor PEX pipes can always be identified, thanks to marking along the entire pipe length. The pipes are always marked with product name, outer diameter, material thickness, production date, consecutive metre-marking, as well as pressure and temperature classes. Depending on pipe type, the current standard or norm, as well as a type approval mark, may also be shown.

1.3 Coated pipes

PEX material, like many plastics, allows oxygen molecules to pass through it. No oxygen diffusion takes place in tap water system, because the tap water is already oxygenated to saturation point.

Heating systems, on the other hand, have requirements for resistance to diffusion. The pipes we use for radiator connections and heating systems are therefore equipped with an oxygen diffusion barrier of Ethyl Vinyl Alcohol (EVOH). This layer is extruded seamless on the outside of the Uponor PEX pipe.

Our coated pipes fulfil the requirement for oxygen diffusion resistance as per DIN 4726 and ISO 17455.

1.4 Conduits

The conduit is manufactured from HD polyethylene in different colours. All conduits can be used in an ambient temperature range of $-20\text{ }^{\circ}\text{C}$ to $+120\text{ }^{\circ}\text{C}$. The pipes are corrugated, which provides great flexibility and great load-bearing capacity.

Uponor conduits fulfil the Norwegian requirements, Nordtest method, NT VVS-129 including test method no. 02-2014 also KIWA BRL K536 part D.

The conduit insulates the inner pipe and prevents water damage to the body of the building in the event of any pipe leakage, as well as facilitating pipe replacement.

1.5 Insulation

The insulation consists of grey cross-linked polyolefin foam with or without an outer layer of polyethylene (PE).

Insulation, physical and chemical properties

	Value	Unit	Test norm
Insulation thickness	20	mm	
Thermal conductivity (at $23\text{ }^{\circ}\text{C}$)	0.037-0.042	W/mK	DIN 52612
Density	0.025-0.3	g/cm ³	DIN 53420
Fire rate	B2		DIN 4102
Weight	31.2	g/m	
Volume	1039.1	cm ³ /m	
Melting point	105-110	$^{\circ}\text{C}$	
Flash point	420-440	$^{\circ}\text{C}$	ASTM 1929
Combustion temperature	430-450	$^{\circ}\text{C}$	DIN 54836
Solubility in water	Insoluble		

1.6 Approved pipes and conduits

The Uponor PEX pipe undergoes works testing and inspection before the product is delivered. These highly comprehensive procedures cover all aspects, from the raw material to the appearance of the packaging. Dimensions, physical and chemical properties, appearance, markings and so on are all checked.

In addition, inspectors from various national testing bodies visit the works at certain intervals (usually 2-3 times per year) to check our internal testing and control procedures, records, test methods, etc. The inspectors also take random product samples for testing in their own laboratories in accordance with specified test programmes. The results of these quality supervision measures are reported directly to the type approval authorities.

In most countries, components used in tap water and heating systems must be type approved. Uponor PEX received its first type approval from the Swedish Board of Physical Planning and Building

in 1973. In 1977 the pipe was type approved by DVGW, based on testing by international testing institutes.

Since then the Uponor PEX pipes have been approved for distribution of cold and hot domestic water and heating installations in more than 30 countries. In countries where the pipes are type approved, there are also type approved fittings available.

1.7 Packaging

Pipes in dimensions up to 32 mm are supplied in coils packed in cardboard boxes on pallets.

From dimensions 32 mm onwards, the coils are supplied wrapped in black plastic.

Most dimensions are also available as straight lengths packed in plastic sleeves in cardboard box, or in plastic pipe.

Installation instructions come with each pack.

2 Material and pipe properties

Note

Technical specifications for mechanical, thermal and electrical pipe properties are available in the chapter "Technical data".

2.1 Hygienic and non-toxicological

Uponor Aqua pipes have been tested at a number of laboratories throughout the world and are approved for tap water distribution, i.e. the pipes release neither taste, odour nor unhealthy substances regardless of water quality.

Tests in laboratories have shown that Uponor Aqua pipes do not provide any growth environment for bacteria. The pipes comply to the requirements for microbiological growth according to the DVGW standard W270.

2.2 Long-term stability

Few materials have undergone such extensive endurance testing as Uponor PEX. Ten years of continuous pressure testing at 95 °C and an uninterrupted endurance test since 1972 are just a couple of examples. Stress tests show that at a temperature of 70 °C and a pressure level of 1 MPa in continuous operation, the pipe has an estimated service life of more than 50 years.

2.3 Thermal memory

When a Uponor PEX pipe is heated to its softening temperature (129-131 °C), the material returns to its original shape. This characteristic is used to give a very reliable method for shrink mounting sealing devices, for example.

2.4 Temperature resistance

The pipes can be used at a temperature up to 120 °C within time and pressure limits. Uponor PEX has unchanged impact strength even at temperatures below -100 °C.

Freezing

However, Uponor PEX pipes, like all water filled pipes, must be protected against freezing. The material is elastic and can normally tolerate freezing. In the event of freezing, the pipe expands, but returns to its original shape once the ice plug melts. Repeated freezing weakens the pipe.

Uponor PEX pipes without conduit, cast in concrete, will not tolerate freezing. Small air bubbles or cavities are always present in concrete. If the cavities are touching the pipe and freezing occurs, the pipe wall is forced into these cavities and the pipe is perforated, which results in leakage.

2.5 Low friction

The extremely low friction coefficient of Uponor PEX yields low pressure drops and minimises the risk of deposits.

2.6 Resistance of abrasion

The abrasion characteristics are very good: erosion corrosion does not occur even at high water velocity. Consequently Uponor PEX pipes are used to transport highly abrasive sand slurry, for example.

2.7 Chemical resistance

The Uponor PEX pipe has a very high resistance to chemicals. Building materials such as concrete, mortar, plaster, etc. do not affect the pipes negatively.

Tape, paint or sealing compounds containing softening agent must not be used directly on the pipe; softening agents have a negative effect on the pipe's long-term properties.

If in doubt about the chemical resistance, please consult Uponor for further information.

2.8 Scratch resistant

Uponor PEX can withstand minor scratches without being weakened, because the material is resistant to crack growth. This property makes it possible to lay pipes directly in stony ground without costly preparation.

2.9 Sound absorbing

The material in Uponor PEX pipes is elastic and provides a shock-absorbing function in the event of rapid shut-off of a solenoid valve, for example. It absorbs sound and can transport solid materials, e.g. woodchips without the risk of loud noise levels.

2.10 Vibration absorbing

Uponor PEX can absorb and withstand vibrations. Thanks to the elasticity action of the PEX material, the surge is reduced to 30 %.

2.11 Electrical insulation

The electrical insulation properties of Uponor PEX are in the same class as the best insulating materials. The material is non-polar and totally free of impurities.

2.12 Low environmental impact

Uponor PEX is a material with minimal environmental impact in both production and energy recovery. In the event of complete combustion, only carbon dioxide and water are formed.

2.13 UV light

Uponor PEX pipes must not be stored or fitted where they are exposed to direct sunlight. UV radiation affects the material, impairing its long-term properties.

3 Pipe descriptions

3.1 Uponor Aqua Pipe



Uponor Aqua pipes are used in tap water systems. The pipes are produced according to EN ISO 15875 class 2 in 6 or 10 bar versions.

Uponor Aqua and Uponor Combi Pipes are treated in accordance with the new hygienic requirement in the Positive Lists for Organic Materials, 4MS Common Approach.

Applications

Pipe	Application
Uponor Aqua Pipe	Tap water systems
Uponor Aqua Pipe in conduit	Tap water systems in concealed installations with conduit
Uponor Aqua Pipe insulated	Tap water systems where there is a risk of condensation or freezing
Uponor Aqua Pipe in insulated conduit	Tap water systems in concealed installations with conduits and insulation

Pipe layers

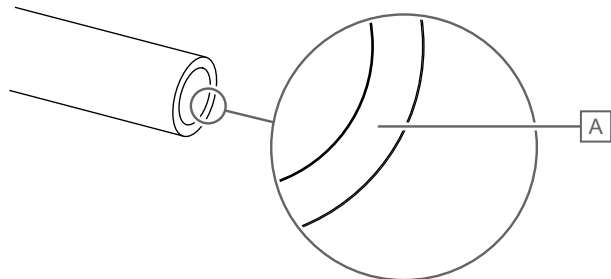

Item	Description
A	Basic pipe of cross-linked polyethylene (PE-Xa)

Fittings



Note

Only use fittings recommended by Uponor or its representatives.

Always use fittings with support sleeves together with Uponor pipes.

Uponor Q&E and Wipex fittings have been specially developed for use with Uponor pipes.

Press fittings and compression fittings designed for these Uponor pipes are also available. Ensure that the compression fitting has a split compression ring.

Pipe dimensions



Note

Detailed information about the range of components, dimensions etc is available in the price list.

OD = outer diameter, ID = inner diameter.

Uponor Aqua Pipe, 6 bar

Pipe OD x material thickness, mm	Pipe ID, mm	Weight, kg/100 m	Volume, l/100 m
16x1.8	12.4	7.5	12.1
20x1.9	16.2	10.1	20.6
25x2.3	20.4	15.4	32.7
32x2.9	26.2	24.9	53.9
40x3.7	32.6	39.6	83.4
50x4.6	40.8	61.5	130.7
63x5.8	51.4	97.7	207.4
75x6.8	61.4	136.6	295.9
90x8.2	73.6	197.6	425.2
110x10.0	90.0	294.5	635.9

Uponor Aqua Pipe, 10 bar

Pipe OD x material thickness, mm	Pipe ID, mm	Weight, kg/100 m	Volume, l/100 m
12x1.7	8.6	5.2	5.8
15x2.5	10.0	9.2	7.9
16x2.2	11.6	8.9	10.6
18x2.5	13.0	11.4	13.3
20x2.8	14.4	14.2	16.3
22x3.0	16.0	16.8	20.1
25x3.5	18.0	22.2	25.4
28x4.0	20.0	28.3	31.4
32x4.4	23.2	35.8	42.3
40x5.5	29.0	55.9	66.0
50x6.9	36.2	87.6	102.9
63x8.6	45.8	137.8	164.7
75x10.3	54.4	196.3	232.3
90x12.3	65.4	281.5	335.8
110x15.1	79.8	422.1	499.9
125x17.1	90.8	543.4	647.2

Uponor Aqua Pipe in conduit

Pipe OD x material thickness, mm	Conduit OD/ID, mm	Weight, kg/100 m	Volume, l/100 m
15x2.5	25/20	9.2	7.9
16x2.2	25/20	8.9	10.6
18x2.5	28/23	11.4	13.3
20x2.8	28/23	14.2	16.3
22x3.0	34/28	16.8	20.1
25x3.5	34/28	22.2	25.4
28x4.0	54/48	28.3	31.4

Uponor Aqua Pipe in insulated conduit

Pipe OD x material thickness, mm	Conduit OD/ID, mm	Insulation ID/ thickness, mm	Weight, kg/ 100 m
15x2.5	25/20	28/10	19.0
18x2.5	28/23	31/10	24.6
22x3.0	34/28	37/20	43.5

3.2 Uponor Combi Pipe

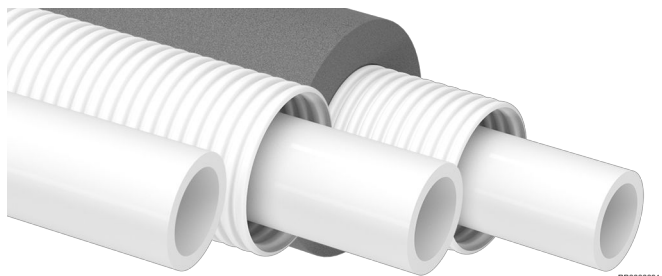

Uponor Combi Pipes are used for tap water systems and supply lines for heating systems, and are produced by Engel process and with an oxygen diffusion barrier of EVOH (Ethyl Vinyl Alcohol). This layer is extruded seamless on the outside of the Uponor Combi Pipe.

Uponor Aqua and Uponor Combi Pipes are treated in accordance with the new hygienic requirement in the Positive Lists for Organic Materials, 4MS Common Approach.

The Uponor Combi Pipes fulfil the requirements for oxygen diffusion resistance as per DIN 4726 and ISO 17455.

Applications

Pipe	Application
Uponor Combi Pipe	Tap water and heating systems
Uponor Combi Pipe in conduit	Tap water and heating systems in concealed installations with conduit
Uponor Combi Pipe insulated	Tap water and heating systems where there is a risk of condensation or freezing
Uponor Combi Pipe in insulated conduit	Tap water and heating systems in concealed installations with conduits and insulation

Pipe layers

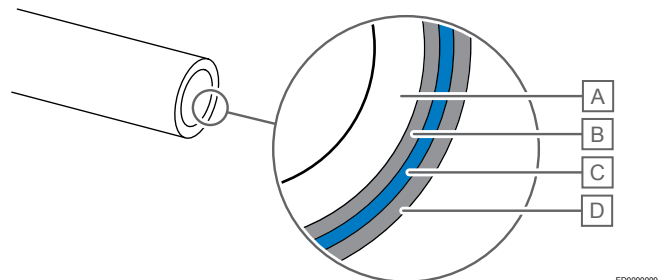

Item	Description
A	Basic pipe of cross-linked polyethylene (PE-Xa)
B	Adhesive layer of modified polyethylene (PE)
C	Diffusion barrier of ethyl vinyl alcohol (EVOH)
D	Adhesive layer of modified polyethylene (PE)

Fittings

Note
Only use fittings recommended by Uponor or its representatives.

Always use fittings with support sleeves together with Uponor pipes.

Uponor Q&E and Wipex fittings have been specially developed for use with Uponor pipes.

Press fittings and compression fittings designed for these Uponor pipes are also available. Ensure that the compression fitting has a split compression ring.

Pipe dimensions

Note
Detailed information about the range of components, dimensions etc is available in the price list.

OD = outer diameter, ID = inner diameter.

Uponor Combi Pipe

Pipe OD x material thickness, mm	Pipe ID, mm	Weight, kg/ 100 m	Volume, l/ 100 m
12x1.7	8.6	5.2	5.8
15x2.5	10.0	9.2	7.9
16x2.0	12.0	8.3	11.3
16x2.2	11.6	9.0	10.6
18x2.5	13.0	11.4	13.3
20x2.8	14.4	14.3	16.3
22x3.0	16.0	17.0	20.1
25x3.5	18.0	22.3	25.4
28x4.0	20.0	28.5	31.4

Uponor Combi Pipe in conduit

Pipe OD x material thickness, mm	Conduit OD/ID, mm	Weight, kg/ 100 m	Volume, l/ 100 m
12x1.7	18/14.6	9.2	5.8
15x2.5	25/20	15.3	7.9
16x2.0	25/20	12.3	11.3
16x2.2	25/20	15.0	10.6
18x2.5	28/23	20.5	13.3
20x2.8	28/23	23.3	16.3
22x3.0	34/28	27.0	20.1
25x3.5	34/28	32.3	25.4
28x4.0	54/48	49.5	31.4

Uponor Combi Pipe in insulated conduit

Pipe OD x material thickness, mm	Conduit OD/ID, mm	Insulation ID/ thickness, mm	Weight, kg/ 100 m
15x2.5	25/20	31/10	19.5
16x2.2	25/20	28/10	18.8
18x2.5	28/23	31/10	24.7
20x2.8	28/23	31/10	27.5
22x3.0	34/28	37/20	38.1

3.3 Uponor Radi Pipe

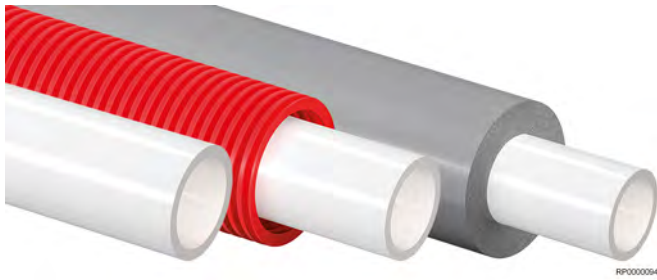

Uponor Radi Pipe has been specially developed for flexible radiator connections. This pipe is seamless and homogeneously coated with an oxygen barrier layer.

Pipes in bigger dimensions, 25-125 mm, are also used as media pipe in Uponor Ecoflex applications.

Uponor Radi Pipe fulfils the requirements for oxygen diffusion resistance as per DIN 4726 and ISO 17455.

Applications

Pipe	Application
Uponor Radi Pipe	Heating systems
Uponor Radi Pipe in conduit	Heating systems in concealed installations with conduit
Uponor Radi Pipe insulated	Heating systems where there is a risk of condensation or freezing

Pipe layers

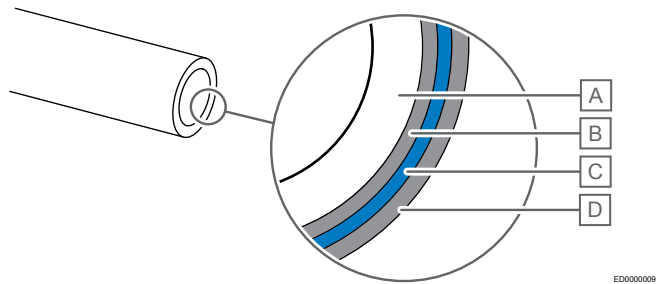

Item	Description
A	Basic pipe of cross-linked polyethylene (PE-Xa)
B	Adhesive layer of modified polyethylene (PE)
C	Diffusion barrier of ethyl vinyl alcohol (EVOH)
D	Adhesive layer of modified polyethylene (PE)

Fittings

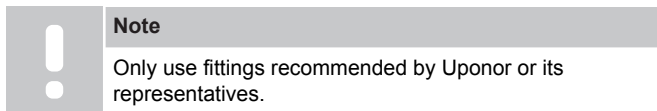

Note

Only use fittings recommended by Uponor or its representatives.

Always use fittings with support sleeves together with Uponor pipes.

Uponor Q&E and Wipex fittings have been specially developed for use with Uponor pipes.

Press fittings and compression fittings designed for these Uponor pipes are also available. Ensure that the compression fitting has a split compression ring.

Pipe dimensions

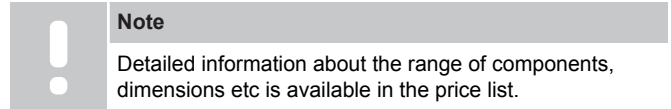

Note

Detailed information about the range of components, dimensions etc is available in the price list.

OD = outer diameter, ID = inner diameter.

Uponor Radi Pipe

Pipe OD x material thickness, mm	Pipe ID, mm	Weight, kg/100 m	Volume, l/100 m
15x2.5	10.0	9.3	7.9
16x2.0	12.0	8.3	11.3
16x2.2	11.6	9.0	10.6
18x2.5	13.0	11.5	13.3
20x2.0	16.0	12.4	19.5
20x2.8	14.4	14.3	16.3
22x3.0	16.0	17.0	20.1
25x2.3	20.4	15.5	32.7
25x3.5	18.0	22.3	25.4
28x4.0	20.0	28.5	31.4
32x2.9	26.2	25.0	53.9
32x4.4	23.2	36.0	42.3
40x3.7	32.6	39.9	83.4
50x4.6	40.8	61.9	130.7
63x5.8	51.4	98.2	207.4
75x6.8	61.2	137.2	295.9
90x8.2	73.6	198.3	425.2
110x10	90.0	295.8	635.9

Uponor Radi Pipe in conduit

Pipe OD x material thickness, mm	Conduit OD/ID, mm	Weight, kg/100 m	Volume, l/100 m
15x2.5	25/20	15.3	7.9
16x2.0	25/20	14.3	11.3
18x2.5	28/23	19.5	13.3
22x3.0	34/28	27.0	20.1
28x4.0	54/48	49.5	31.4

Uponor Radi Pipe insulated

Pipe OD x material thickness, mm	Insulation ID/ thickness, mm	Weight, kg/100 m	Volume, l/100 m
15x2.5	18/10	12.2	7.9
22x3.0	25/13	21.9	20.1
28x4.0	31/20	38.45	31.4

3.4 Uponor Teck conduits



Uponor Teck are conduits made of high-density polyethylene (HDPE). They are designed to protect the interior of flexible multi-layer pipes used for tap water and heating applications. The conduits are produced in different colours depending on which applications they are aimed for.

Using pipe in conduit installation reduces the risk of water damages and allow for flexible media pipe to be replaced.

Fire classification E according to EN 13501-1.

Uponor conduits fulfil the Norwegian requirements, Nordtest method, NT VVS 129 including test method no. 02-2014 also KIWA BRL K536 part D.

Pipe layers

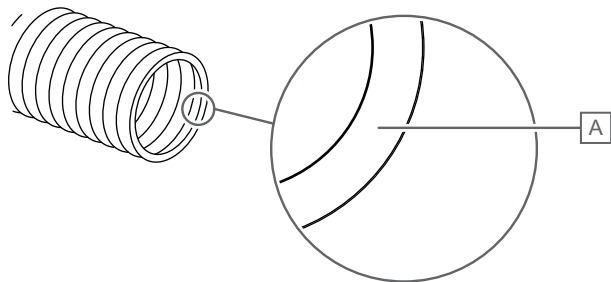

Item	Description
A	High-density polyethylene (HDPE)

Pipe dimensions

OD = outer diameter, ID = inner diameter.

Note	
Detailed information about the range of components, dimensions etc is available in the price list.	

Uponor Teck

Conduit OD/ID, mm	Colour
25/20	Black, Blue, Red, White
28/23	Black, Blue, Red, White
35/29	Black, Blue, Red, White
43/36	Black
54/48	Black, White

Uponor Teck, Nordtest

Conduit OD/ID, mm	Colour
25/20	Black, White
28/23	Black, White/blue, White/red, White
34/28	Black, White

Uponor Teck in insulation

Conduit OD/ID, mm	Colour	Insulation ID/thickness, mm
54/48	Black	57/20

3.5 Uponor Comfort Pipe PLUS



Uponor Comfort Pipe PLUS is a pipe with an oxygen diffusion barrier. This barrier consists of a layer of ethyl vinyl alcohol (EVOH) extruded on the outside of the PEX pipe. The outermost layer is polyethylene (PE). This layer is very flexible and does not affect the flexibility and pliability of the basic pipe.

Uponor Comfort Pipe PLUS fulfils the requirements for oxygen diffusion resistance as per DIN 4726 and ISO 17455.

Applications

Pipe	Application
Uponor Comfort Pipe PLUS	Underfloor heating systems

Pipe layers

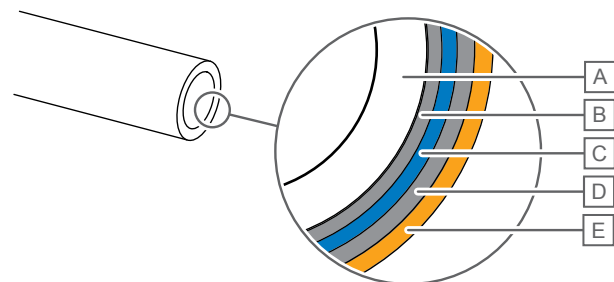

Item	Description
A	Basic pipe of cross-linked polyethylene (PE-Xa)
B	Adhesive layer of modified polyethylene (PE)
C	Diffusion barrier of ethyl vinyl alcohol (EVOH)
D	Adhesive layer of modified polyethylene (PE)
E	Outer layer of polyethylene (PE)

Fittings

Note	
Only use fittings recommended by Uponor or its representatives.	

Always use fittings with support sleeves together with Uponor pipes.

Uponor Q&E fittings have been specially developed for use with Uponor pipes.

Press fittings and compression fittings designed for these Uponor pipes are also available. Ensure that the compression fitting has a split compression ring.

Pipe dimensions

!	Note
	Detailed information about the range of components, dimensions etc is available in the price list.

OD = outer diameter, ID = inner diameter.

Uponor Comfort Pipe PLUS

Pipe OD x material thickness, mm	Pipe ID, mm	Weight, kg/100 m	Volume, l/100 m
14x2.0	10.0	7.1	7.9
16x2.0	12.0	8.3	11.3
17x2.0	13.0	10.4	13.3
20x2.0	16.0	10.7	20.1
25x2.3	20.4	15.4	32.7

3.6 Uponor Klett Comfort Pipe PLUS



Uponor Klett Comfort Pipe PLUS is a pipe used for heating applications. The pipe is equipped with a hook fastening tape wound around it.

When the pipe is pressed into the correct position against the special laminated panel used for the installation, the hooks catch the foil loops and secure the pipe, guaranteeing maximum fixture.

Applications

Pipe	Application
Uponor Klett Comfort Pipe PLUS	Heating systems

Pipe layers

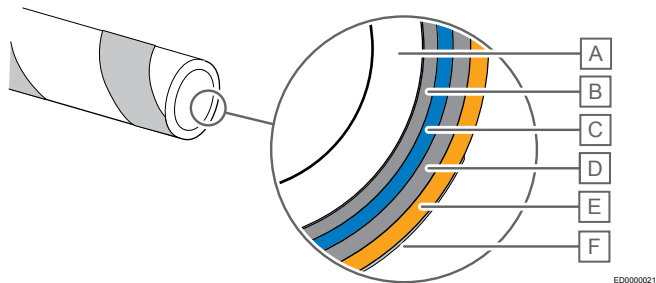

Item	Description
A	Basic pipe of cross-linked polyethylene (PE-Xa)
B	Adhesive layer of modified polyethylene (PE)
C	Diffusion barrier of ethyl vinyl alcohol (EVOH)
D	Adhesive layer of modified polyethylene (PE)
E	Outer layer of polyethylene (PE)
F	Self-adhesive hook fastening tape wound

Fittings

!	Note
	Only use fittings recommended by Uponor or its representatives.

Always use fittings with support sleeves together with Uponor pipes.

Uponor Q&E fittings have been specially developed for use with Uponor pipes.

Press fittings and compression fittings designed for these Uponor pipes are also available. Ensure that the compression fitting has a split compression ring.

Pipe dimensions

!	Note
	Detailed information about the range of components, dimensions etc is available in the price list.

OD = outer diameter, ID = inner diameter.

Uponor Klett Comfort Pipe PLUS

Pipe OD x material thickness, mm	Pipe ID, mm	Weight, kg/100 m	Volume, l/100 m
14x2.0	10.0	7.1	7.9
16x2.0	12.0	8.3	11.3

3.7 Uponor Minitec Comfort Pipe



Uponor Minitec Comfort Pipe is specially developed for underfloor heating on existing screed, timber or tiled floors. It is optimised for near-surface heating in residential buildings.

The pipe is seamless and homogeneously coated with an oxygen barrier layer. The installation height is only 15 mm and consists of a self-adhesive foil element and a PE-Xa pipe in dimension 9.9 mm.

Uponor Minitec Comfort Pipe fulfils the requirements for oxygen diffusion resistance as per DIN 4726 and ISO 17455.

Applications

Pipe	Application
Uponor Minitec Comfort Pipe	Heating systems

Pipe layers

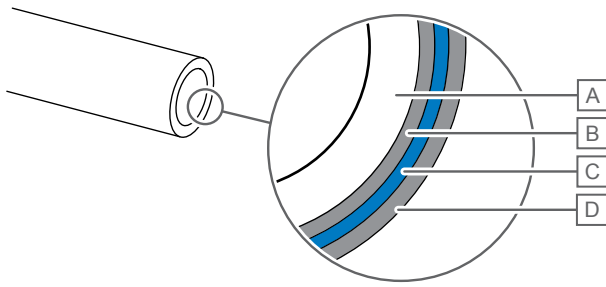

ED000009

Item	Description
A	Basic pipe of cross-linked polyethylene (PE-Xa)
B	Adhesive layer of modified polyethylene (PE)
C	Diffusion barrier of ethyl vinyl alcohol (EVOH)
D	Adhesive layer of modified polyethylene (PE)

Fittings

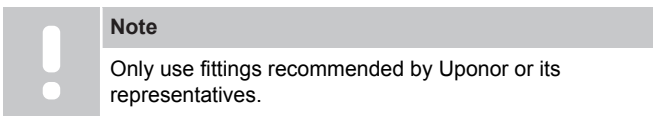

Always use fittings with support sleeves together with Uponor pipes.

Uponor Q&E fittings have been specially developed for use with Uponor pipes.

Press fittings and compression fittings designed for these Uponor pipes are also available. Ensure that the compression fitting has a split compression ring.

Pipe dimensions

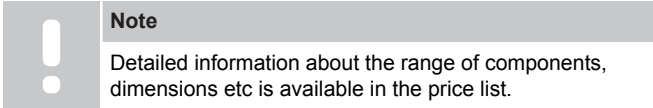

OD = outer diameter, ID = inner diameter.

Uponor Minitec Comfort Pipe

Pipe OD x material thickness, mm	Pipe ID, mm	Weight, kg/100 m	Volume, l/100 m
10.2x1.3	7.6	3.5	4.5

3.8 Uponor Meltaway PEX Pipe



RP000002

The Uponor Meltaway PEX Pipe is manufactured from silane cross-linked polyethylene (PE-Xb).

It is not oxygen diffusion resistant and must be connected to other heating systems with an intermediate heat exchanger.

The Meltaway pipe is specially designed for streets, market squares and football pitches. It can be covered with asphalt, sand, flagstones or cast in concrete.

Manifolds and distributing pipes including fittings are made of high-density polyethylene. In other words, all components are made of the same material and have the same coefficient of linear expansion.

Applications

Pipe	Application
Uponor Meltaway PEX Pipe	Outdoor surface warming, snow and ice melting

Operating temperature and pressure

Maximum permitted operating temperature for Uponor Meltaway PEX Pipes is 50 °C at 4.5 bar.

Pipe layers

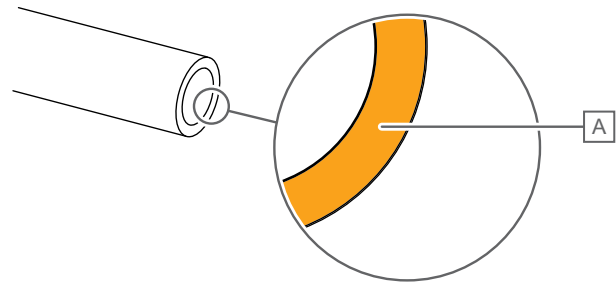

ED000006

Item	Description
A	Basic pipe of silane cross-linked polyethylene (PE-Xb)

Fittings

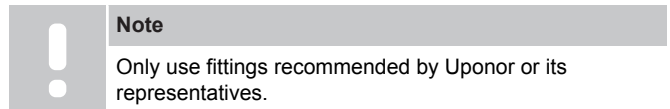

Uponor Meltaway fittings and manifolds for Uponor Meltaway PEX pipes are completely made of plastic with O-ring seals.

Pipe dimensions

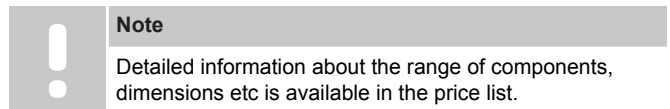

OD = outer diameter, ID = inner diameter.

Uponor Meltaway PEX Pipe

Pipe OD x material thickness, mm	Pipe ID, mm	Weight, kg/100 m	Volume, l/100 m
25x2.3	20.4	17.0	31.7

Uponor Meltaway feeder tubes

Pipe OD x material thickness, mm	Pipe ID, mm	Length (L), mm
75x6.8	61.4	6000
110x6.6	96.8	6000
160x9.5	141.0	6000
200x11.9	176.2	6000

3.9 Uponor Meltaway PLUS PE-Xa orange



RP0000093

The Uponor MELTAWAY PLUS PE-Xa orange pipe consists of a PE-Xa basic pipe with orange coating.

It is not oxygen diffusion resistant and must be connected to other heating systems with an intermediate heat exchanger.

The Meltaway pipe is specially designed for streets, market squares and football pitches. It can be covered with asphalt, sand, flagstones or cast in concrete.

Manifolds and distributing pipes including fittings are made of high-density polyethylene. In other words, all components are made of the same material and have the same coefficient of linear expansion.

Applications

Pipe	Application
Uponor Meltaway PEX Pipe	Outdoor surface warming, snow and ice melting

Operating temperature and pressure

Maximum permitted operating temperature for Uponor Meltaway PEX Pipes is 50 °C at 4.5 bar.

Pipe layers

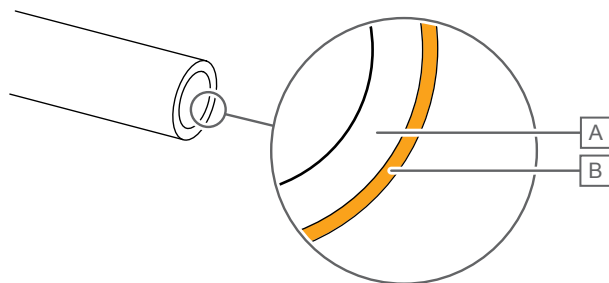

ED0000008

Item	Description
A	Basic pipe of cross-linked polyethylene (PE-Xa)
B	Outer layer of polyethylene (PE), Orange

Fittings

Note
Only use fittings recommended by Uponor or its representatives.

Uponor Meltaway fittings and manifolds for Uponor Meltaway PEX pipes are completely made of plastic with O-ring seals.

Pipe dimensions

Note
Detailed information about the range of components, dimensions etc is available in the price list.

OD = outer diameter, ID = inner diameter.

Uponor Meltaway PLUS PE-Xa orange

Pipe OD x material thickness, mm	Pipe ID, mm	Weight, kg/100 m	Volume, l/100 m
25x2.3	20.4	17.0	31.7

Uponor Meltaway feeder tubes

Pipe OD x material thickness, mm	Pipe ID, mm	Length (L), mm
75x6.8	61.4	6000
110x6.6	96.8	6000
160x9.5	141.0	6000
200x11.9	176.2	6000

4 Component descriptions

Note

This section briefly describes some of the components in the Uponor PEX product family.

For more detailed information, product range and documentation please visit the Uponor website: www.uponor.com.

4.1 Uponor Q&E fittings



RPO000101

The Uponor Q&E fitting is developed based on a method where a Uponor PEX pipe is gradually expanded with a Q&E (PEX) ring fitted on the outside, and then allowing it to shrink back onto a fitting nipple. The technique can be used due to the fact that the Uponor PEX material is capable of shrinking back to almost its original size, even after a very large amount of extensions (elongation).

By this type of connection, the reduction of inner diameter is much less than on ordinary fittings. It is almost the same as the inner diameter on the pipe.

The components of the Uponor Q&E system have been very carefully designed to ensure optimum ease of fitting and the best possible sealing function. The designs of the fitting nipple and the expander segments have been carefully matched to one another, to the Uponor PEX pipe and to the Q&E ring. Design modifications and/or dimensional changes to the nipple, expander segments or the expanding procedure will entirely alter all of the basic conditions.

Testing and approvals

The manufacturing of both fittings and pipes is subject of periodic inspections by ATG, KIWA, MPA, SP and QAS.

Uponor Q&E fittings got their first certifications in 1995. Since then they have been tested in performance and certified by several independent official accredited laboratories, such as ATG (Belgium), DVGW (Germany), KIWA (the Netherlands), MPA (Germany), SP (Sweden), TGM (Austria), QAS (Australia) as well as in Uponor's own laboratories.

Uponor Q&E is also certified for gas applications by Gastec in the Netherlands.

Range of fittings

Uponor Q&E fittings are available in brass, dezincification resistant brass (DR) and a durable, proven plastic called polyphenylsulphone (PPSU).

No other tool than an expander tool is needed for connecting the pipe to the fitting.

Brass



RPO000102

Two different materials are used for Uponor Q&E metal fittings. One is brass and the other is dezincification resistant brass (DR).

Plastic (PPSU)



RPO000103

Uponor Q&E fittings made of polyphenylsulphone (PPSU) have low weight and very low internal roughness. They are non-toxic with good chemical resistance.

Uponor Q&E rings

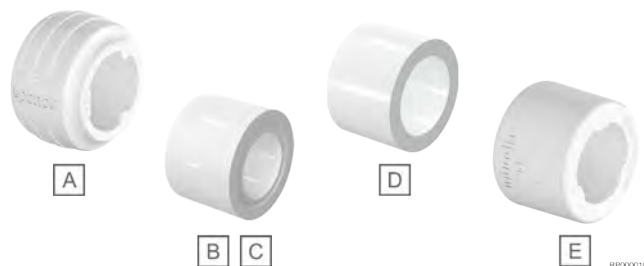

RPO000103

Item	Description	Colour	Dimension, mm
A	Uponor Q&E evolution ring	White; Blue; Red	16, 20, 25, 32
B	Uponor Q&E ring with stop edge	Natural	16, 20, 25, 32, 40, 50, 63, 75
		Blue; Red	12, 16, 25
C	Uponor Q&E ring with stop edge	Natural	12, 16, 25
D	Uponor Q&E ring natural, eval	Natural	14
E	Uponor Q&E ring with stop edge NKB	White	15, 18, 22, 28

The function of the Q&E ring is to enhance the shrinking force after expansion and strengthen the tightness of the connection.

Dimensions



Note

Detailed information about the range of components, dimensions etc is available in the price list.

Uponor Q&E fittings are available for pipe dimensions 16-75 mm.

4.2 Uponor Wipex fittings



RP0000104

The Uponor Wipex fitting is a very safe fitting produced by Uponor. It is specifically designed for connecting cross-linked polyethylene pipes for hot and cold water in domestic and district heating installations.

The fitting is robust and simple in design. It can be fitted very easily and quickly even in difficult locations and confined spaces. No bulky tools are required. The ring spanner used when tightening the fitting is very small and convenient to use in relation to the size of the fitting.

The Uponor Wipex fitting is designed to give an excellent tight grip. The gripping strength is higher than the tensile strength of the pipe, and the sealing performance is unaffected by temperature fluctuations.

Testing and approvals

The Uponor Wipex fitting has been tested in performance by several independent official accredited laboratories such as according to DVGW (Germany), NKB (Sweden), CSTB (France) and KIWA (the Netherlands), and approved.

Range of fittings



RP0000105

The Uponor Wipex fittings are available in dezincification resistant brass (DR) or gun metal (Rg). O-rings are used to seal between the fittings and pipe fittings.

All tools needed are two fixed wrenches plus a pair of pliers.

Dimensions



Note

Detailed information about the range of components, dimensions etc is available in the price list.

Uponor Wipex fittings are available for pipe dimensions 25-110 mm, in two series marked PN 6 and PN 10.

4.3 Compression fittings



RP0000110



Note

Always use fittings with support sleeves together with Uponor pipes.

Ensure that the compression fitting has a split compression ring.

A wide range of fittings are available for the easy and secure connection of plastic pipes; mainly compression fittings, among others of various manufacture.

For the safest fittings, Uponor pipes should be connected with approved fittings recommended by Uponor or any of our retailers.

The Uponor recommended fittings have been tested in performance by several independent official accredited laboratories, as well as in Uponor's own laboratories.

Dimensions



Note

Detailed information about the range of components, dimensions etc is available in the price list.

4.4 Manifolds



RP0000108

Uponor offers manifolds in brass and plastic suitable for both tap water and heating applications with a wide range of connection possibilities.

A manifold installation with Uponor components offers the following advantages:

- Fewer connection points
- Accessible connection points
- Reduced pressure and temperature variances
- Quick installation

Brass

Uponor Aqua PLUS manifold WTR PEX DR



RP0000136

Uponor Aqua PLUS manifold WTR PEX DR is a high quality manifold made of dezincification resistant brass for tap water applications. It consists of flexible modules with 2 or 3 loops supplied with compression fittings. Outlets with G $\frac{3}{4}$ " male threads.

Uponor Q&E manifold NKB DR

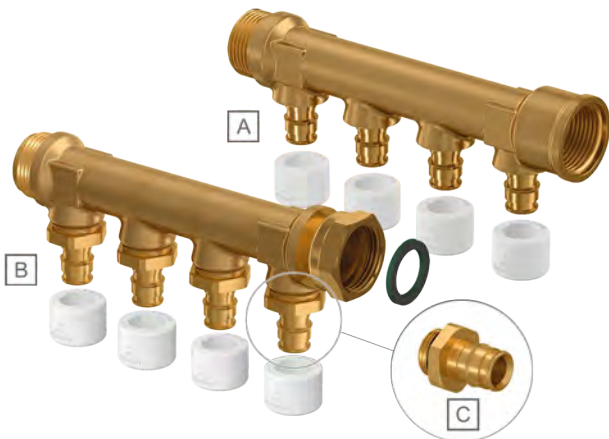

RP0000138

Item	Description
A	Uponor Q&E manifold NKB DR with fixed Q&E outlets
B	Uponor Q&E manifold NKB DR with exchangeable outlets
C	Uponor Aqua PLUS manifold adapter for Q&E manifolds with exchangeable outlets

There are two types of Uponor Q&E manifold NKB DR available, offered mainly on the Nordic markets. They are made of dezincification resistant brass and used for tap water applications.

The manifolds consist of flexible modules with 2, 3 or 4 outlets.

One type has fixed Q&E outlets for easy connection of pipes equipped with Q&E rings.

The other type has exchangeable outlets with a possibility to connect different pipe dimensions to each manifold if desired. Uponor Q&E adapters for manifolds with exchangeable outlets are available in dimensions 12, 15, 16 and 18 mm.

Uponor Vario B



RP0000137

Uponor Vario B WGF is a high quality manifold made of brass for underfloor heating applications that provides easy installation with high reliability.

It consists of flexible modules with 2, 3 or 4 loops and corresponding fill/drain/ventilation sets or primary connection sets.

The secondary connectors allow the connection of all Uponor pipe dimensions which makes the manifold universal for Uponor underfloor heating systems.

Plastic (PPM)

Uponor Aqua PLUS manifold PPM



Note

All parts within the Uponor Aqua PLUS manifold PPM system are fully compatible with each other.



RP0000125

The Uponor Aqua PLUS PPM is a plastic manifold system suitable for both tap water and radiator solutions with a wide range of connection possibilities. The installation is easy and with the available adapters it is possible to connect pipes of different types (Uponor PE-Xa or composite pipes) and dimensions. The pipes are connected to the manifold with Uponor Q&E and Uponor FPL-X fittings for Uponor PE-Xa pipes, Uponor S-Press fittings for composite pipes, or a combination of these options.

Intended use: Together with Uponor pipes the Uponor Aqua PLUS PPM system distributes tap water within the allowed pressure and temperature range.

Uponor Vario PLUS



RP000135

Uponor Vario PLUS is a high quality manifold made of glass fiber reinforced polyamide. It is created for heating applications for easy installation and highest reliability.

The manifold is deliverable in flexible modules of 1, 3, 4 and 6 loops and corresponding fill/drain/ventilation sets or primary connection sets.

The secondary connectors allow the connection of all Uponor pipe dimensions which makes the manifold universal for Uponor underfloor heating systems.

Dimensions



Note

Detailed information about the range of components, dimensions etc is available in the price list.

4.5 Cabinets

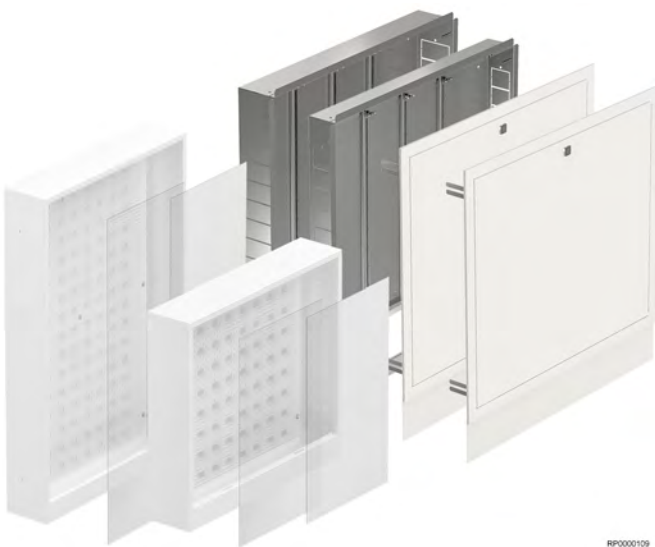

RP000109

In some countries, the Uponor PEX tap water and underfloor heating systems are using manifolds which must be installed in cabinets. In other countries this is an option.

Uponor offers cabinet solutions for both tap water and underfloor heating installations.

Tap water cabinets



RP000121

Uponor has a complete range of cabinets for a quick, easy and watertight tap water installation. There are five different basic designs of the Uponor Aqua PLUS cabinets available:

- **Manifold cabinets** in depths 108 and 118 mm, for manifold installations
- **Riser cabinet** in depth 108 mm, for installation of riser connections in the cabinet
- **Combi cabinet** in depths 118 and 205 mm, for installation of water and heating pipes in the same cabinet
- **Water inlet cabinets** in depth 125 and 150 mm, suitable when installation of water meter is required in the cabinet
- **Outwater cabinet** in depth 70 mm, with a pre-mounted water meter console

The cabinets fulfil the requirements in the Nordtest method NT VVS 129, as well as the Swedish trade regulations Säker Vatten for a correct and watertight installation.

Leak protection



Note

Cabinets give protection against leakage.

Using pipe in conduit installations and leak proof cabinets reduce the risk of water damage in the house. The wall boxes used at the faucets have watertight connections to the pipes and in case of leakage, the water flows within the conduit to the cabinet.

The cabinet is connected to the sewage via a separate pipe in the bottom. Leakage water from the conduit will hence flow to the sewer.

Underfloor heating cabinets



RP0000122

The Uponor Vario cabinet is suitable for underfloor heating installations. It has enough space for necessary Uponor components like manifolds, room control equipment, pump groups, corresponding heat meter sets, valves and similar.

Uponor Vario cabinets are optionally available with the frame and door made of sheet steel or plastic.

The cabinets are adjustable in height and depth:

- Height adjustment: maximum 200 mm
- Depth adjustment: 80–120 mm or 110–150 mm

Dimensions



Note

Detailed information about the range of components, dimensions etc is available in the price list.

4.6 Pre-fabricated units



RP0000139

Pre-fabricated cassette for bathroom installation.

Uponor can offer prefabricated units for a wide range of applications where the Uponor PEX components form the basis; from bathroom cassettes, small tap water and radiator cabinets up to larger cabinets for e.g. underfloor heating or incoming water.

The ready-to-install units are delivered to the construction site ready for installation according to customer specifications, whether it applies to single family houses, multi-storey buildings or commercial

buildings. Upon request, they can also be delivered with specific components like valves, heat meters, and room temperature control system.

5 Application descriptions

The range of Uponor PEX pipes can be used for various applications. This chapter gives a short overview of the core application areas.

For more detailed information, product range and documentation please visit the Uponor website: www.uponor.com.



Note

Installations of the Uponor systems are described in detail in respective installation manual. Visit the Uponor download centre for more information.

5.1 Tap water



Note

The installation must be carried out in accordance with current local standards and regulations!

Please check your country norm, like EN 806-3 or DIN 1988-3, when selecting and calculating the installation.

Tap water systems influence the quality of the drinking water and moisture protection. Therefore the choice of system is a central decision in the building project. A built-in Uponor PEX system is a complete solution that contains all needed components.

Installation configuration

Tap water installations can follow the tee configuration or can be configured with manifolds.

The Uponor tap water system Q&E (PPSU and brass) can be used in both types of installations.

Traditional tee system installation

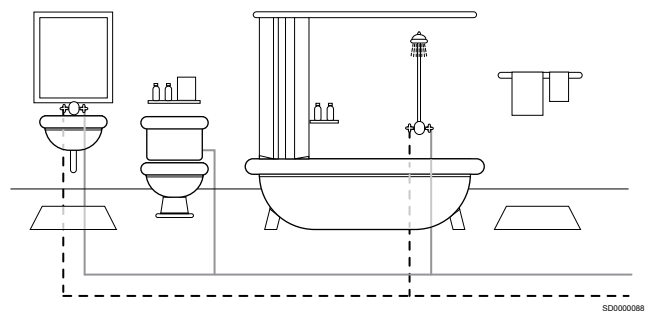

Uponor Tap Water System can be installed in the same fashion as a traditional system made of metal pipes i.e. a "Tee system". The advantage with this installation method is the use of less pipes than the manifold system described below. However, the traditional method has some inherent disadvantages that should be taken into consideration.

The design work for example is more complicated. Most engineers wish to reduce the pipe dimension, from a larger one at the beginning

of the system to a smaller one at the end, which is why calculations are needed to determine the various pipe sizes.

Also, there are temperature and pressure variations due to the fact that one supply pipe normally has more than one draw-off point. In addition, there are more connection points than with the manifold system and these are often inaccessibly situated within the walls.

Furthermore, because of the various pipe dimensions and the large number of corresponding fittings, stock keeping is more complicated on-site.

Manifold system

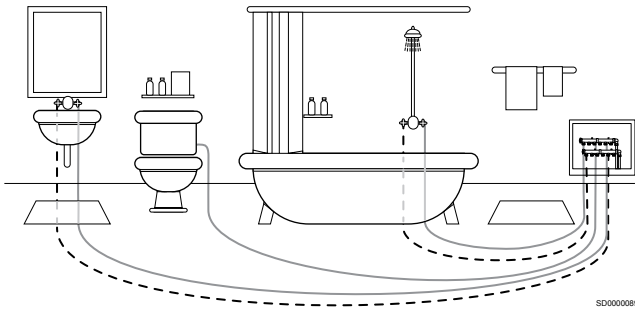

The manifold system does not present any of the above-mentioned difficulties. It can be designed with one single pipe dimension from the manifold to the draw-off point, which simplifies design and installation work.

With connection points only at the manifold and the faucet, the risk of leakage from joints is considerably reduced and there are no awkward connections within the walls. Since there are no other draw-off points on the same supply pipe, pressure and temperature variations are minimal when faucets are turned on and off in varying sequences.

Furthermore fewer pipe dimensions and fittings allow for easier stock keeping and save on installation time and labour costs.

5.2 Radiator heating



There are two main pipes in a traditional system for radiator installation. One supply pipe and one for return, on which the different radiators are connected. Water must always enter the radiator through the top and exit through the bottom.

The supply pipes are installed in parallel, so the water that reaches each radiator from the boiler and returns directly to it. The supply temperature in all radiators is practically the same in this type of installation.

There are two installation possibilities: direct return or Tichelmann.

Direct return installation

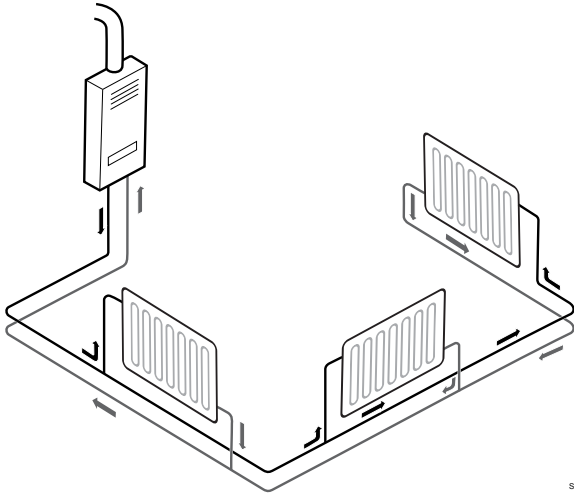

The return pipe starts from the most distant radiator and collects the water from the different radiators until it is returned to the boiler.

The water path is shorter for closer radiators so pressure loss is lower and the flow must be properly regulated.

Tichelmann installation

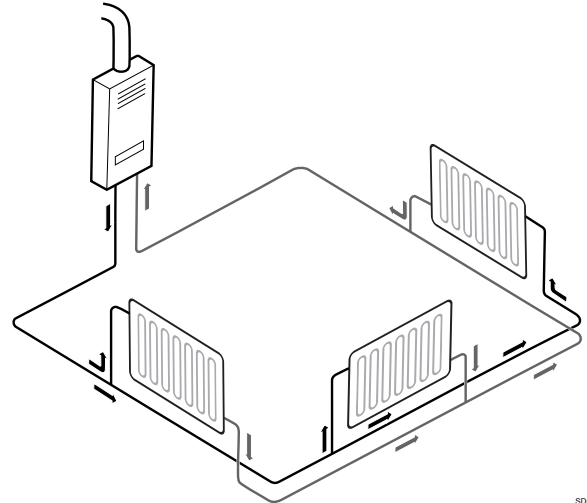

The return pipe starts from the closest radiator to the boiler and continues in the direction of the supply until it reaches the boiler.

The paths to each radiator have similar lengths and no flow regulation is required.

5.3 Underfloor heating

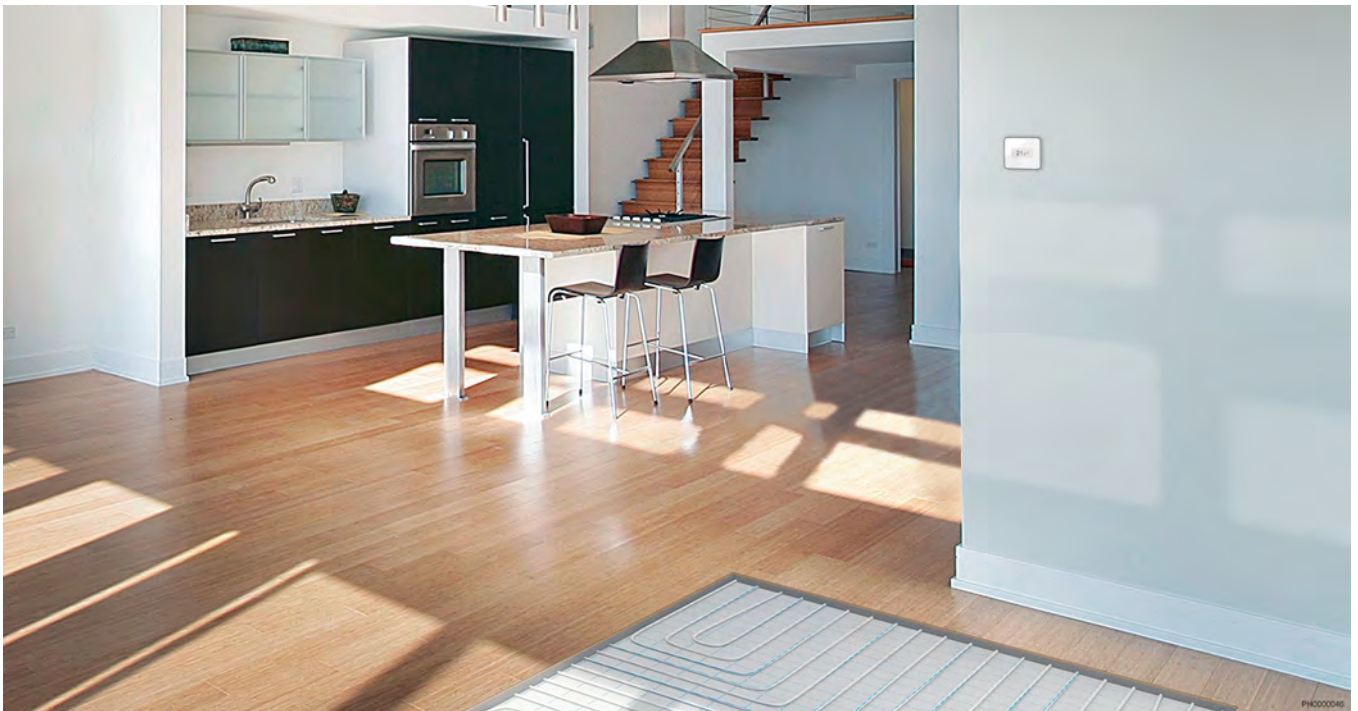

Uponor underfloor heating systems are available for installation in both wet and dry floor constructions.

Concrete screeded floors

In concrete screed floors or "wet installations", the screed spreads the heat out across the surface and thereby provides an even floor surface temperature.

Wooden suspended floors

Wooden suspended floors or "dry installations" do not conduct heat as efficiently as concrete. Consequently heat diffusion plates are

required in this type of installation in order to achieve an even floor temperature.

Floating floors

On concrete floors it is possible to install underfloor heating using polystyrene panels provided with grooves for the heat diffusion plates and the pipes. This alternative can be used on all types of planed floors.

5.4 Surface heating



Uponor Surface heating is an adjustable application for different structures. It is especially designed for outdoor use in driveways, ramps, fire department or hospital approach roads, helicopter landing zones, side walks, football pitches, etc.

The pipes can be covered with asphalt, gravel, paving stones, sand or can be cast into concrete slab.

Wide variety of heat sources

The Uponor Surface system needs a minimum of +35 °C water temperature to function which means that a wide variety of heat sources can be used, including district heating return water, waste heat from various processes, heat pumps, etc. The heat from any suitable source can be transferred through a heat exchanger to the Uponor snow and ice melting system.

5.5 Industrial applications



Uponor Industrial Applications offer a diverse range of solutions satisfying specific requirements from customers in different industrial fields. The solutions are based on standard or tailor made products manufactured or designed by Uponor, such as pipes, fittings and components.

Pipes for industrial applications

Uponor Industrial Applications supply Uponor PEX pipes for a variety of applications. The pipes can be specified according to standard pipe sizes and in some instances according to specific pipe size requirements when it comes to outer diameter, inner diameter and wall thickness.

Other features available are non standard coil lengths, coating, colour, shape, etc. The pipes can be processed and shaped according to customer drawings and specifications.

Fittings and connection techniques

Uponor fittings are available for different applications e.g. Uponor Q&E and Wipex fittings. The material of the fittings include brass, PPSU or stainless steel depending on the application.

Other connection techniques are based on PEX flanges. A solution spanning from small pipe sizes to larger bore pipes within the Uponor PEX pipe range.

Applications

Uponor Industrial Applications deliver pipes and components used in environments with strict requirements for cleanliness, such as in the medical field.

The pipes are used in water cooling circuits for power electronics according to customer drawings.

Other applications take advantage of specific properties of the Uponor PEX pipes, such as flexibility, abrasion or scratch resistance.

6 Installation and operation

6.1 Installation process

Note
Installation must be performed by a competent person in accordance with local standards and regulations.

The installation process varies from country to country. Always follow the local standards and regulations whenever the Uponor systems should be installed.

As a guidance, always read and follow the instructions given in respective Uponor installation manual.

6.2 Pressure and tightness testing

For thermoplastic and multi-layer pipe in tap water and radiator heating installations, tests carried out in accordance with Method A of the Standard ENV 12108-02 will be considered to be valid.

- Once the aforementioned test has been carried out, the installation will be connected to the taps and consumption devices and subjected to the test again.
- The pressure gauge used in this test must detect pressure intervals of at least 0.1 bar.
- These pressures refer to street level.

Test method

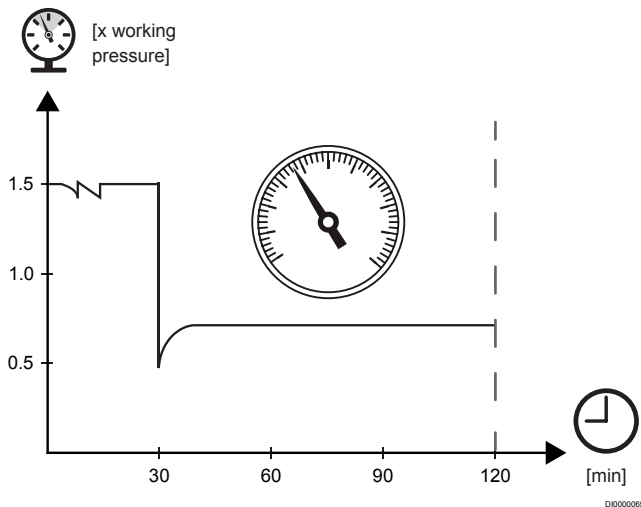

The test consists of the following steps:

1. Vent and fill the system with potable drinking water.
2. Visually inspect the whole system for leaks.
3. Pressurise the installation to a test pressure of not less than 1.5 times the maximum working pressure.
4. Apply the test pressure by pumping for a period of 30 minutes. Inspect for leaks.
5. Reduce the pressure in the pipework by bleeding water from the system to 0.5 times the maximum working pressure.
6. Close the bleed valve.
7. Visually check for leakage and monitor for 90 minutes. If there is no reduction in pressure the system is regarded as leak tight.
8. Flush the system as required.

6.3 Forces of expansion and contraction

Forces of expansion and contraction can appear when a pipe has been installed at an ambient temperature of about 20 °C and is then suddenly exposed to a water temperature of 90 °C.

Forces can appear during both expansion and contraction. However if the temperature changes gradually, or if the pipe can give sideways, the strength of the forces will diminish. Naturally sideways movement can be influenced by pipe length and by clamping, but note that the length of the pipe has no bearing on the size of the force.

Pipe dimension, mm	Shrinking force, N
22x3.0	250
25x2.3	200
25x3.5	300
28x4.0	400
32x2.9	400
32x4.4	500
40x3.7	600
40x5.5	800
50x4.6	900
50x6.9	1300
63x5.8	1500
63x8.7	2100
75x6.8	2100
90x8.2	2900
110x10.0	4400

6.4 Shrinking

Permitted shrinking in lengths as per standards for PEX pipes, EN ISO 15875 is a maximum of 3 %.

Always consider the shrinking in length of the Uponor PEX pipes when planning the installation.

6.5 Bending radius

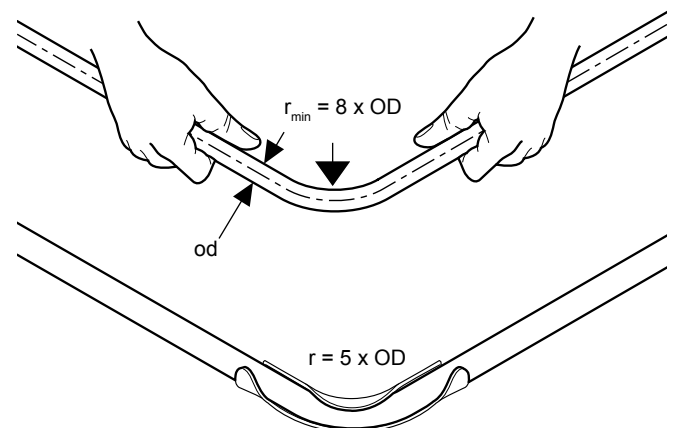



Minimum recommended bending radius in general pipes is 8 x outer diameter (OD).

Minimum recommended radius with hot bending is 5 x outer diameter (OD) when using a bending support.

Narrower bending radii occur when using bending supports as well as various other fittings, such as wall elbows. These have been tested for Uponor PEX pipes and do not have any negative effect on the long-term properties of the pipes.

6.6 Kinked pipes

	Caution! Do not use an open flame for heating. Use a hot-airgun.
---	--

	Caution! Do not heat Uponor pipes used in heating installations. They have an outer oxygen diffusion barrier which, if heated, will be damaged.
---	---

In the case of accidental kinking of a pipe during installation, the pipe should be heated gently and very carefully. The thermal memory in the material will be activated and the pipe reforms to original shape.

1 Straighten the damaged section

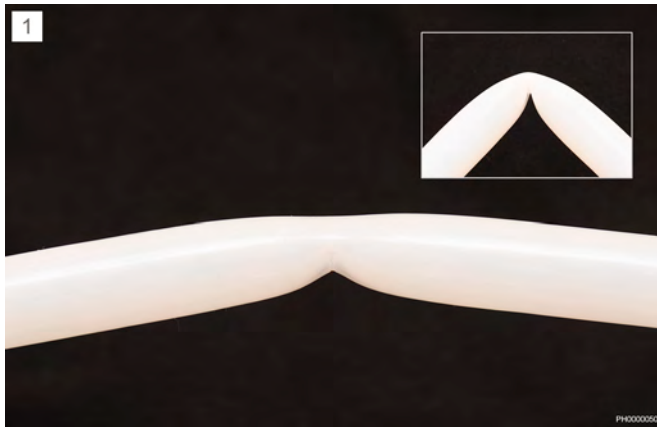

Straighten the damaged section by hand.

2 Carefully heat the damaged area



Carefully heat the damaged area with a hot-air gun, rotating the gun around the pipe throughout the process for an even application.

3 Heat until transparency



Heat until the pipe has returned to its original shape or until the material begins to become transparent round its whole circumference. This will happen at around 130 °C.

- Keep heating to a minimum. It is not always necessary to heat the pipe until it is transparent before it resumes its original shape.
- Note any change in the pipes surface. If heating has discoloured the pipe, this indicates that the material has been damaged and the pipe needs replacing

4 Cool to room temperature



Allow the pipe to cool to room temperature or by using a wet rag before use. Using cold water or blowing cold air on the repaired section will accelerate cooling.

5 Original appearance



Once cooled, the pipe will return to its original appearance and regain all of its strength.

7 Technical data

7.1 Technical specifications

Mechanical properties

Description	Value	Unit	Test norm
Density	0.938	g/cm ³	
Tensile strength (20 °C)	19-26	N/mm ²	DIN 53455
(100 °C)	9-13	N/mm ²	
E-module (20 °C)	800-900	N/mm ²	DIN 53457
(80 °C)	300-350	N/mm ²	
Ultimate elongation (20 °C)	350-550	%	DIN 53455
(100 °C)	500-700	%	
Impact strength (20 °C)	No rupture	kJ/m ²	DIN 53453
(-140 °C)	No rupture	kJ/m ²	
Moisture absorption (22 °C)	0.01	mg/4 d	DIN 53472
Friction coefficient against steel	0.08-0.1	—	
Surface energy	34x10 ⁻³	N/mm ²	
Oxygen permeability (20 °C)	0.8x10 ⁻⁹	g m/m ² s bar	DIN 4726
(55 °C)	3.0x10 ⁻⁹	g m/m ² s bar	

Thermal properties

Description	Value	Unit	Test norm
Temperature range	-100 to +100	°C	
Linear expansion coefficient (20 °C)	1.4x10 ⁻⁴	m/m°C	DIN 53752
(100 °C)	2.05x10 ⁻⁴	m/m°C	
Softening temperature	+130	°C	DIN 53460
Specific heat	2.3	kJ/kg°C	
Coefficient of thermal conductivity (20 °C)	0.35	W/m°C	DIN 52612

Electrical properties

Description	Value	Unit	Test norm
Specific internal resistance (20 °C)	10 ¹⁵	W m	
Dielectric constant (20 °C)	2.3	—	DIN 53483
Dielectric loss factor (20 °C/50 Hz)	1x10 ⁻³	—	DIN 53483
Disruptive voltage (0.5 mm foil) (20 °C)	2.3	kV/mm	DIN 53481, VDE 0303

Pipe properties

Description	Value	Unit	Test norm
Cross-linking level			
PE-Xa	>70	%	EN ISO 15875
PE-Xb	>65	%	EN ISO 15875
PE-Xc	>60	%	EN ISO 15875
Oxygen diffusion resistance			
Uponor Comfort Pipe PLUS, Uponor Radi Pipe	≥0.10	g/(m ³ d)	DIN 4726
Min. laying temperature			DIN 53460
Uponor Comfort Pipe PLUS, Uponor Radi Pipe	-15	°C	
Uponor Aqua Pipe	-20	°C	DIN 52612
Max. operating temperature			
Uponor Aqua Pipe insulated, Uponor Radi Pipe	+95	°C	
Uponor Comfort Pipe PLUS	+95	°C	

7.2 Service conditions and design pressure



Note

The derivation of $S_{\text{calc, max}}$ is provided in annex A. The method described takes account of the properties of PE-X under service conditions for the classes given in Table 1 of the EN ISO 15875-1:2003.

The maximum calculated pipe value, $S_{\text{calc, max}}$, for the applicable class of service conditions and design pressure, p_D , shall conform to the table below.

Maximum calculated pipe values, table 1

P_D bar	Application class			
	Class 1	Class 2	Class 4	Class 5
	$S_{\text{calc, max}}$ values ^a			
4	7.6 ^b	7.6 ^b	7.6 ^b	7.6 ^b
6	6.4	5.9	6.6	5.4
8	4.8	4.4	5.0	4.0
10	3.8	3.5	4.0	3.2

Source: EN ISO 15875-1:2003.

a) The values are rounded to the first place of decimals.

b) The 20 °C, 10 bar, 50 years, cold water requirement, being higher, determines this value (see clause 4 of EN ISO 15875-1:2003).

The values of outside diameter and/or wall thickness apply to the cross-linked polyethylene pipe and are exclusive of additional outside layers. For pipes with barrier layers (ISO 15875-1:2003, clause 3.1.4) the values of outside diameter and wall thickness may apply to the finished product, including the barrier layer, provided that the thickness of the outside barrier layer including any adhesive layer shall be ≤ 0.4 mm and the design calculation using the values of outside diameter and wall thickness of the base pipe (PE-X) meet the $S_{\text{calc, max}}$ -values in Table 1.

The manufacturer shall state the dimensions and tolerances of the base pipe in his documentation when different from Tables 2 to 6 of this standard.

Classification of function conditions as per EN ISO 15875

Application class	Operating temperature T_D (°C)	Time at T_D (years)	T_{max} (°C)	Time at T_{max} (years)	T_{mal} (°C)	Time at T_{mal} (hours)	Typical application	
1 ^a	60	49	80	1	95	100	Hot water distribution (60 °C)	
2 ^a	70	49	80	1	95	100	Hot water distribution (70 °C)	
4 ^b	20	2.5					Underfloor heating and low temperature radiators	
	Followed by							
	40	20						
	Followed by							
			70	2.5	100	100		
	60	25						
	Followed by (see next column)		Followed by (see next column)					
5 ^b	20	14					High temperature radiators	
	Followed by							
	60	25						
	Followed by							
			90	1	100	100		
	80	10						
	Followed by (see next column)		Followed by (see next column)					

Source: EN ISO 15875-1:2003.

Note

For values exceeding those in the table for T_D , T_{max} and T_{mal} , this standard is not applicable.

a) In order to comply with national regulations, a country may apply either class 1 or 2.

b) Where more than one operating temperature is shown for any class, the times must be added up, e.g. the operating temperature

profile for 50 years for class 5 is: 20 °C for 14 years followed by 60 °C for 25 years, 80 °C for 10 years, 90 °C for one year and 100 °C for 100 h.

All systems that fulfil the requirements as per the table above are also suitable for transporting cold water for a period of 50 years at a temperature of 20 °C and an operating pressure of 10 bar.

In heating installations, only water or treated water must be employed as a heat carrier.

7.3 Linear expansion diagram

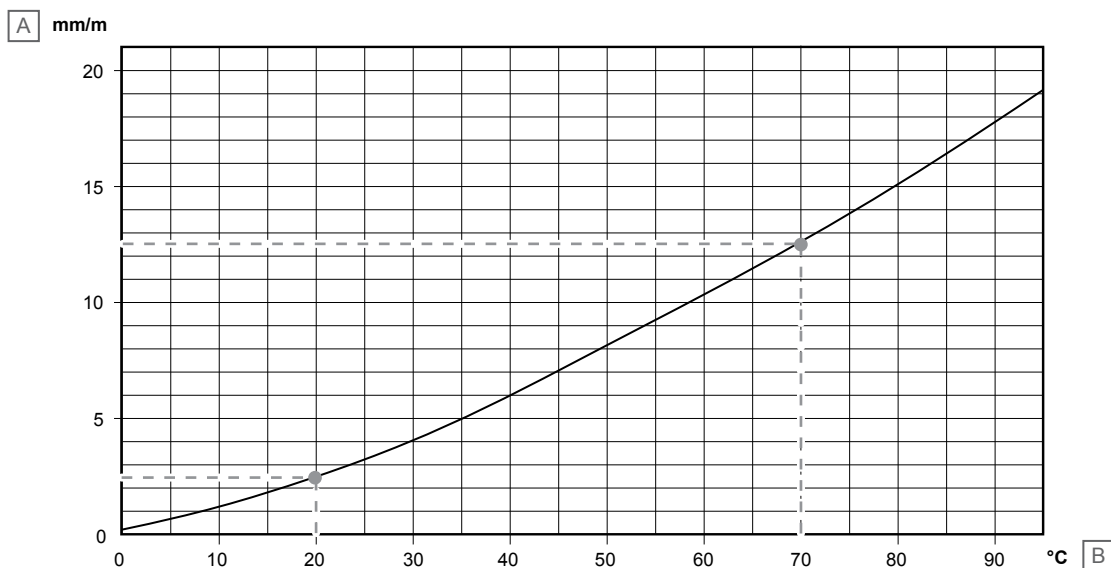

Item	Description
A	Linear expansion, mm/m
B	Temperature, °C

Uponor PEX pipes have great linear expansion and small expansive forces compared to metal pipes. With concealed installation, linear expansion takes place between pipe and conduit.

With visible installation, the expansive forces are transferred to expansion absorbing devices or to the building structure through fixing.

transported water has a temperature of 70 °C? According to the diagram, the thermal expansion is 2.5 mm/m at 20 °C. At 70 °C, the expansion is 12.5 mm/m.

The pipe expands $12.5 \text{ mm/m} - 2.5 \text{ mm/m} = 10 \text{ mm/m}$ when transporting the hot water.

Installation example

A riser pipe transporting hot water is installed at an ambient temperature of 20 °C. How much will the riser expand if the

7.4 Heat emission loss diagrams

Uponor PEX 1.0 MPa 90 °C

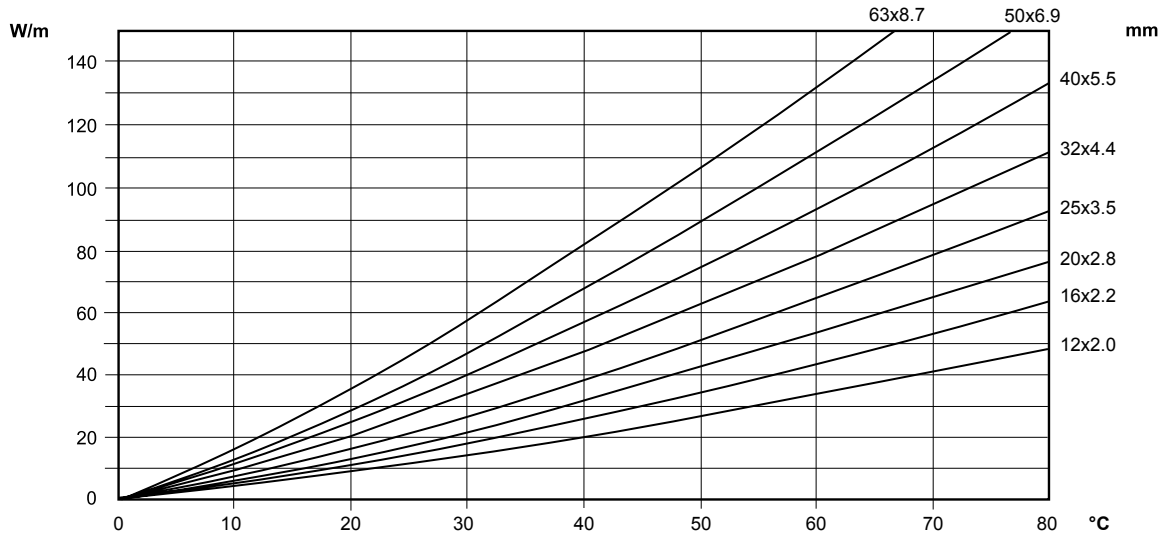

D10000053

Uponor PEX 0.6 MPa 90 °C

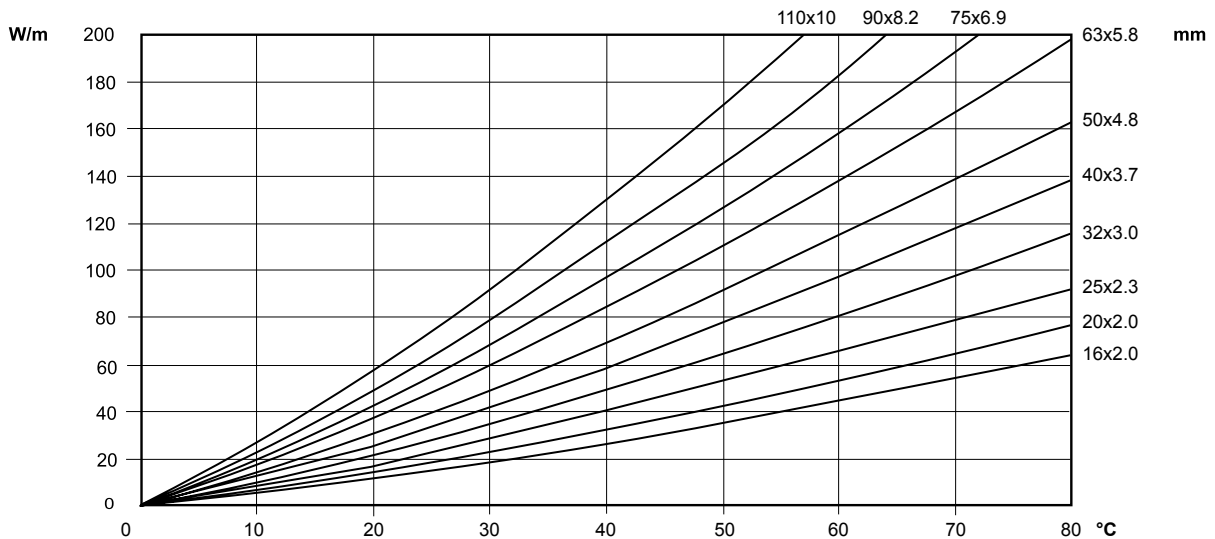

D10000054

7.5 Pressure drop nomogram

Uponor Aqua Pipe

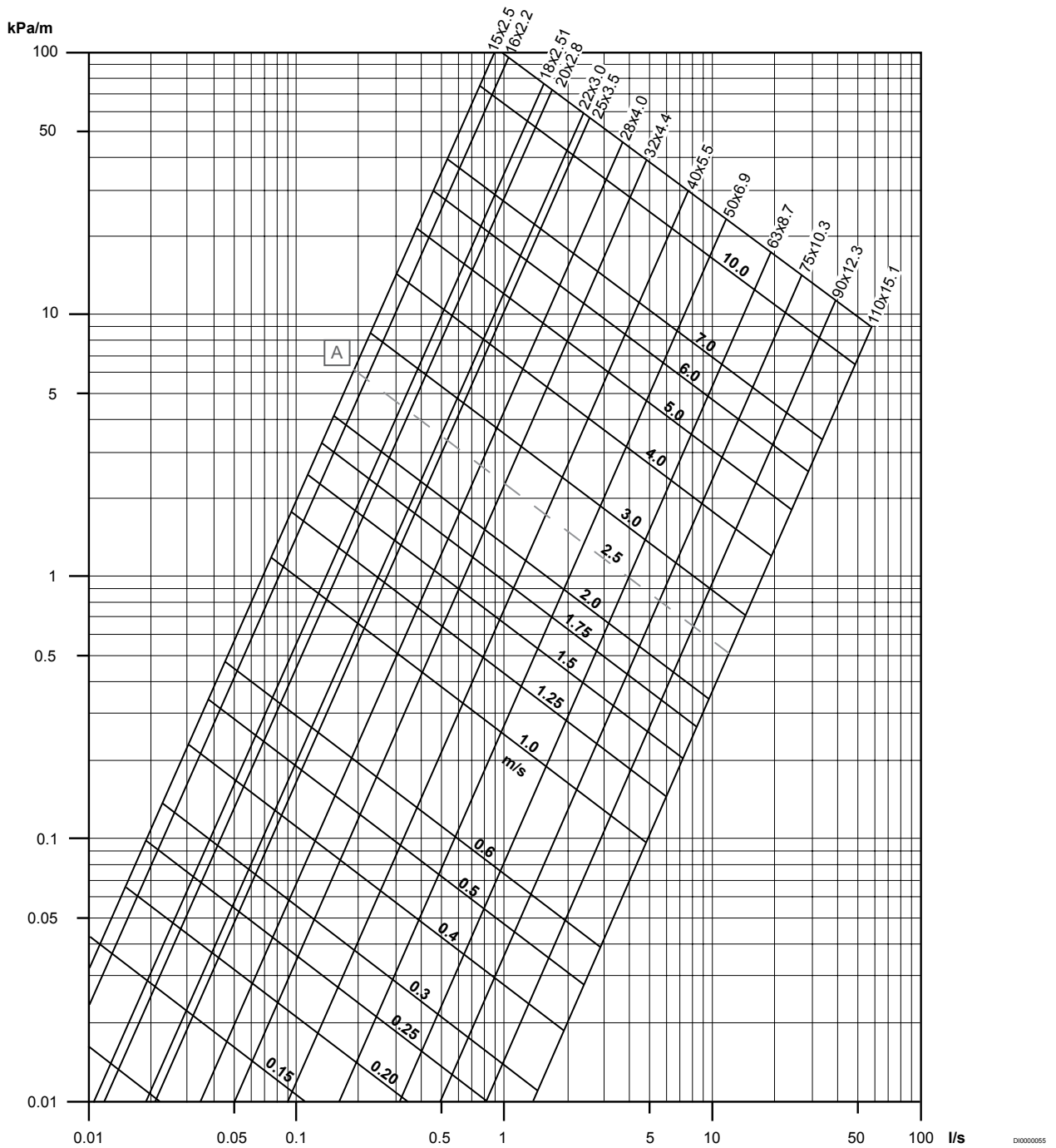

The nomogram is calculated at a water temperature of +70 °C.

Item	Description
A	Recommended max. water speed with continuous flow versus high pressure drops and sound levels

Temp. °C	90	80	70	60	50	40	30	20	10
Factor	0.95	0.98	1.00	1.02	1.05	1.10	1.14	1.20	1.25

Roughness factor 0.0005

Uponor Radi Pipe, Uponor Comfort Pipe PLUS

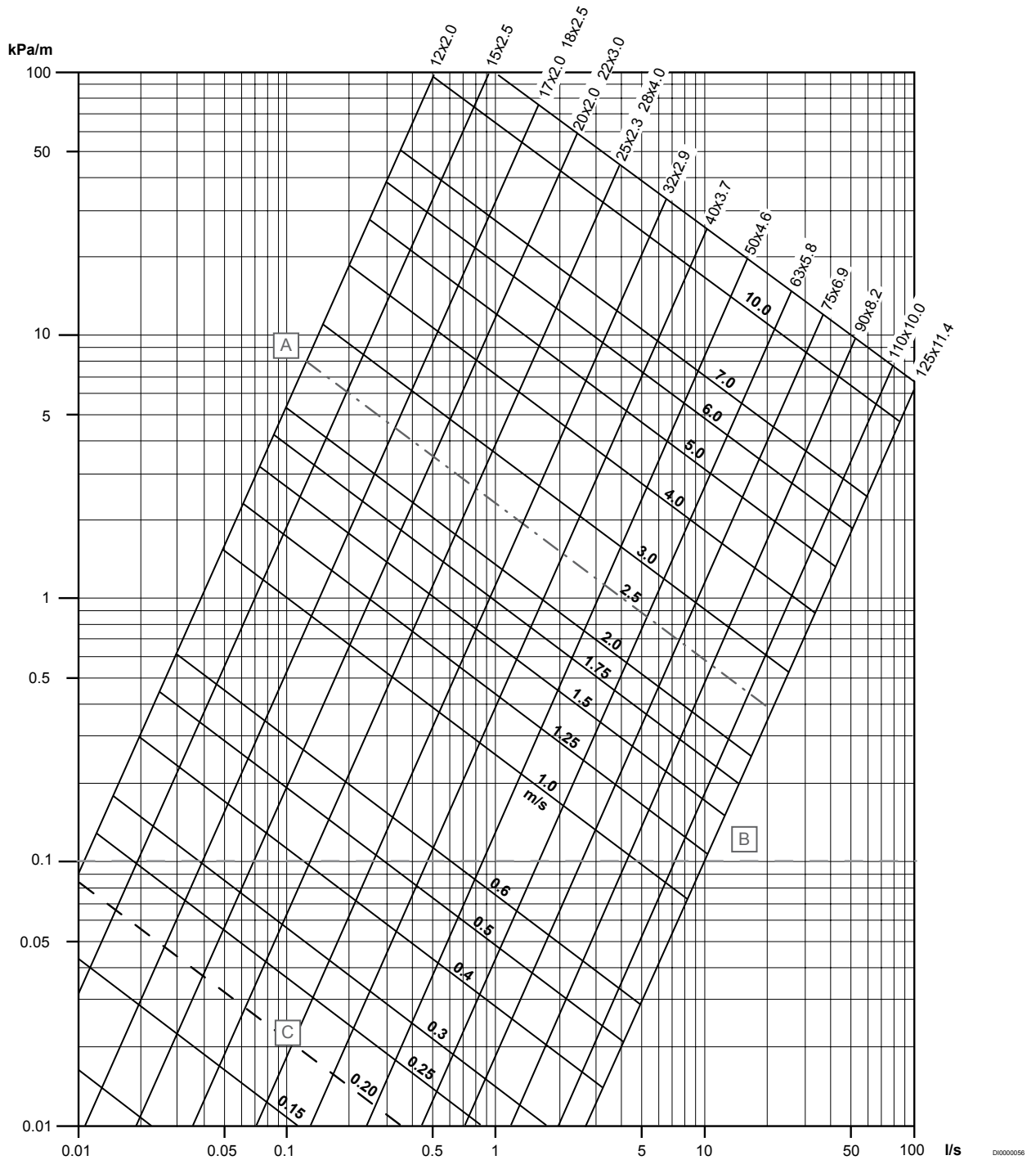

The nomogram is calculated at a water temperature of +70 °C.

Item	Description
A	Guideline for sizing (0.1 kPa)
B	Min. water speed
C	Recommended max. water speed with continuous flow versus high pressure drops and sound levels

Temp. °C	90	80	70	60	50	40	30	20	10
Factor	0.95	0.98	1.00	1.02	1.05	1.10	1.14	1.20	1.25

Roughness factor 0.0005

Uponor Meltaway PEX Pipe

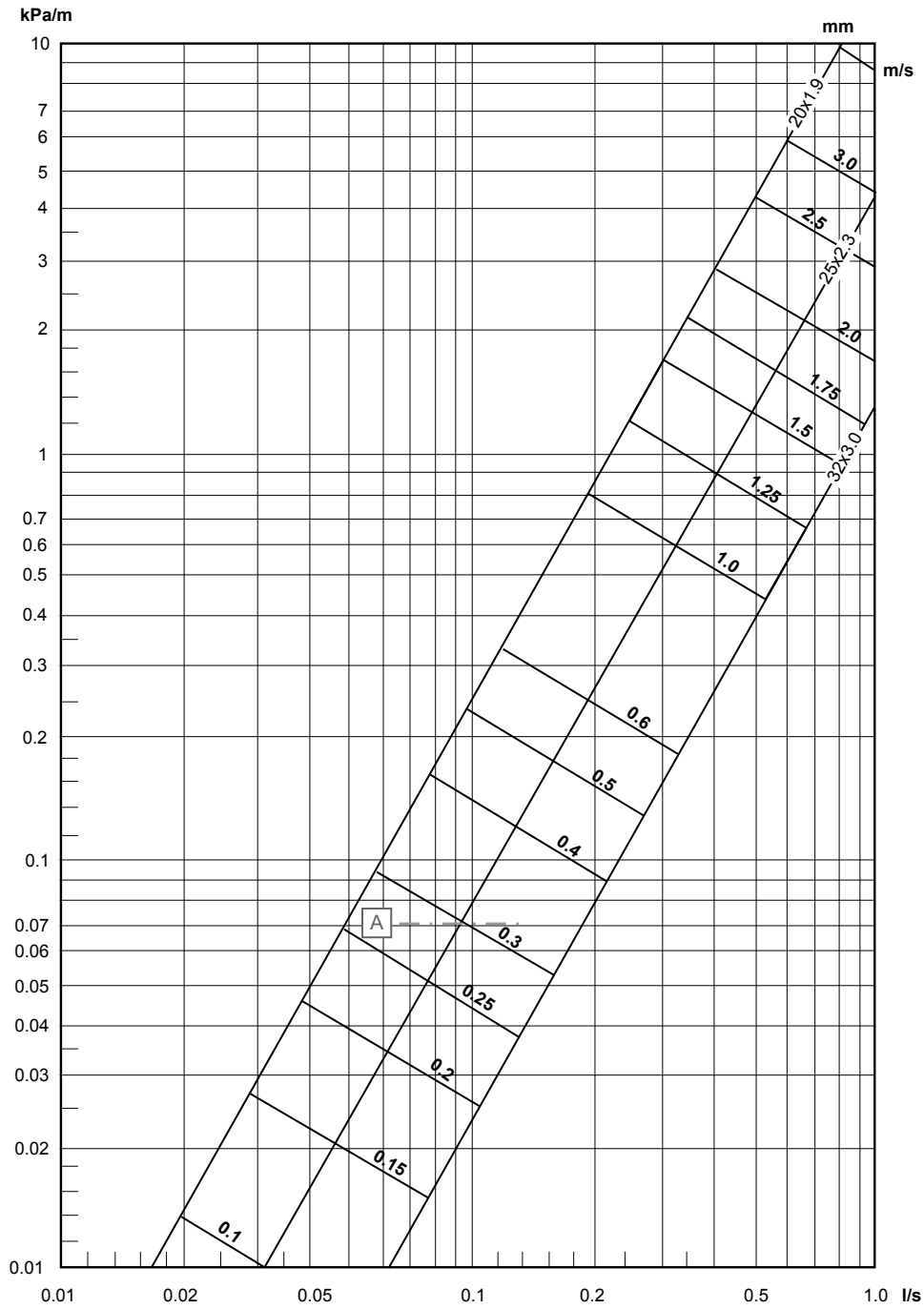

D16000057

The nomogram is calculated at a water temperature of +70 °C.

Item	Description
A	Minimum water speed to achieve self-ventilating function.

Manifold and distributing pipes for Uponor Surface Heating System

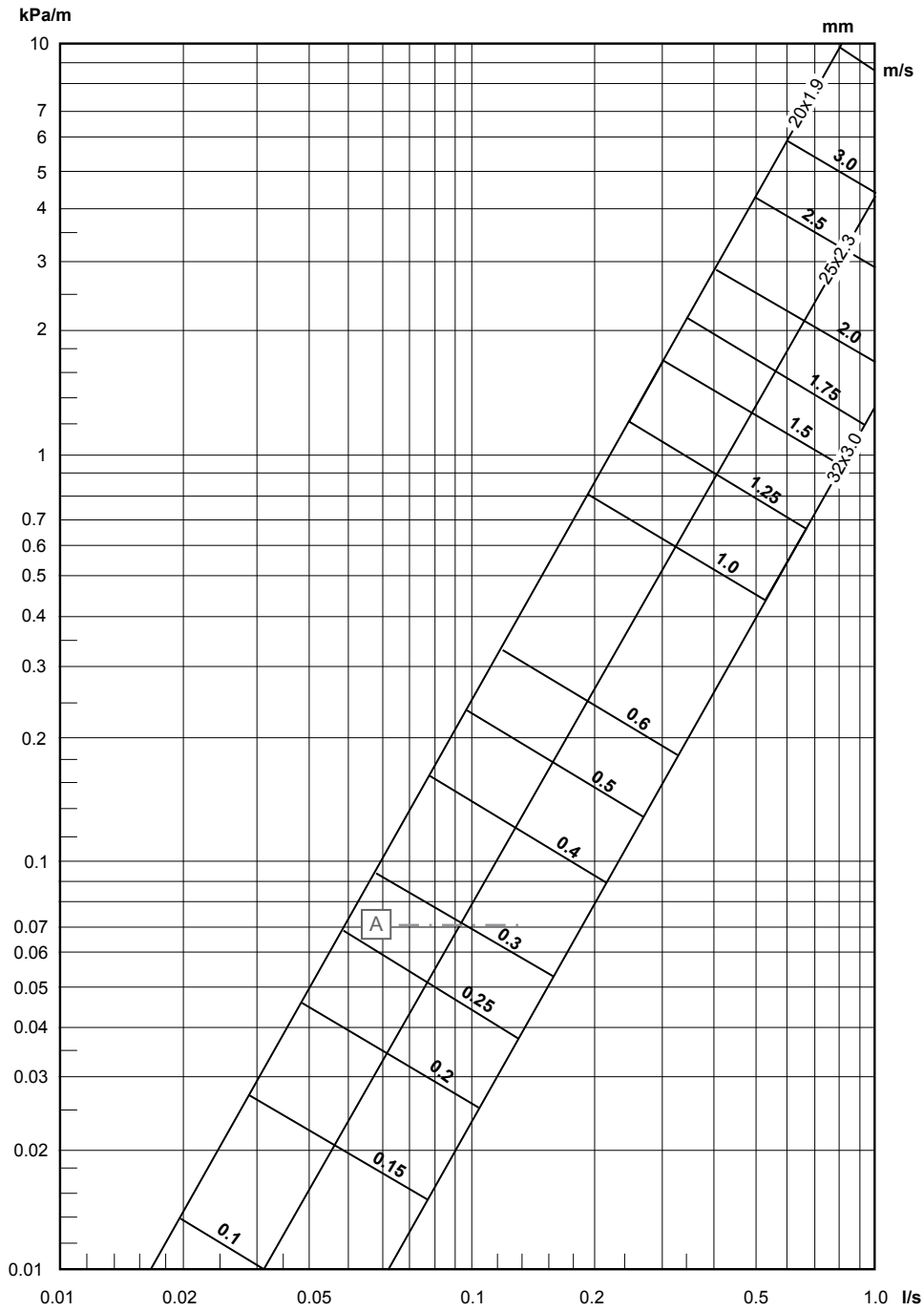

D16000057

The nomogram is calculated at a water temperature of +70 °C.

Uponor

Uponor Corporation

Äyritie 20

01510 Vantaa, Finland

1118689 v1_10_2020_EN
Production: Uponor/ELO

Uponor reserves the right to make changes, without prior notification, to the specification of incorporated components in line with its policy of continuous improvement and development.



www.uponor.com