

# MERKUR

## FOR FASTE TAK

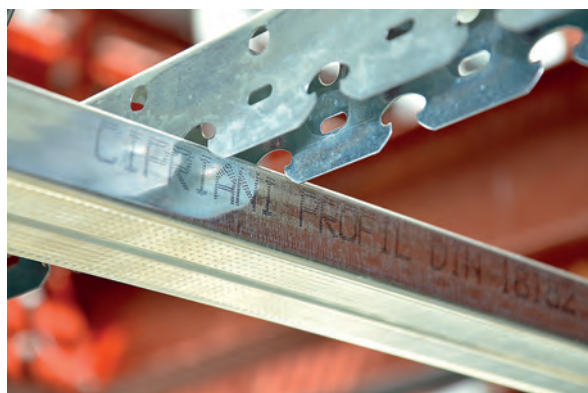

For norske forhold

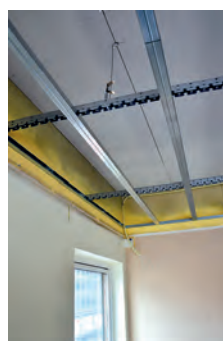
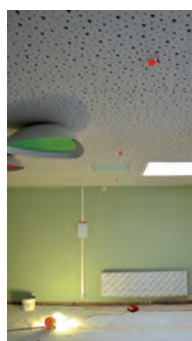
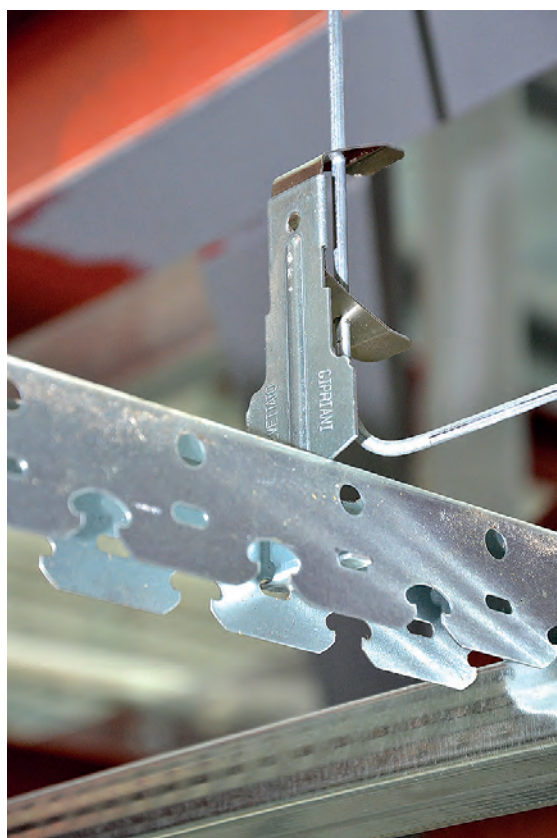

## Rask • Stabil • Stiv • Enkel • Skrue-fri

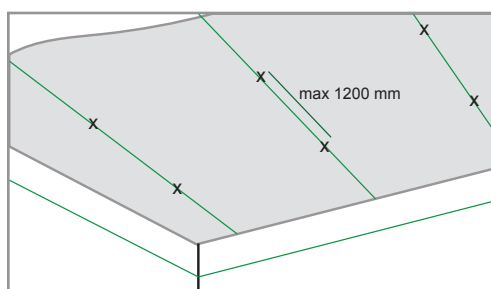

Mål og marker høyden for vegglisten. Marker Merkur profilens (bæreskinne) posisjon (max 1200 mm, se tabell) og posisjonen for innfesting (max 1200 mm, se tabell)

OBS! Første Merkur profil max 1/3 av henger avstand (G) se skisse

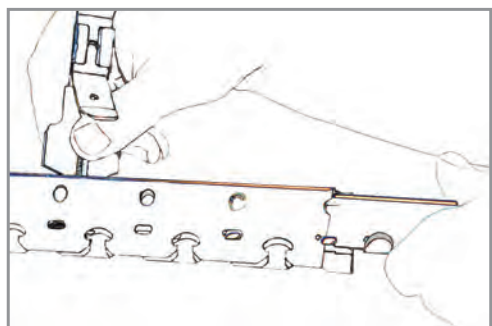

Monter festet (C.033) på hengeren (4 mm) og monter hengeren, mål høyden, enklest med laser. Klikk innfesting i Merkur profilen, skjøt Merkur profilen med skjøtestykke (C.125). For å tilpasse lengden kapp med plate saks.

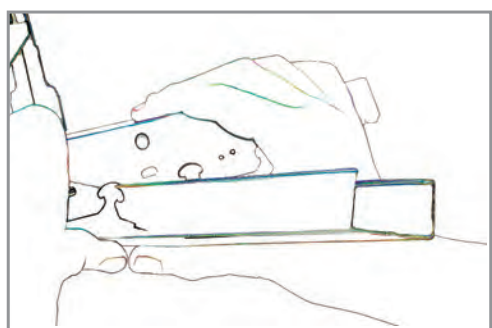

Klikk fast C-profilen med c/c ut fra plateprodusentens anvisning. Skjøt c-profilen minimum 100 mm fra Merkur profilen om mulig. Tilpass lengden kapp med plate saks.

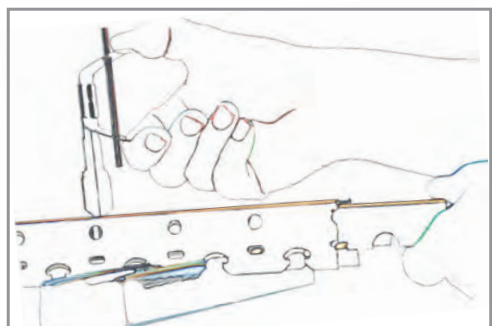

Finjuster høyden, enklest med laser. Start og skru fast plate materialet. Merkur er ett komplett system med flere ulike innfestinger. Se baksiden på dette bladet.

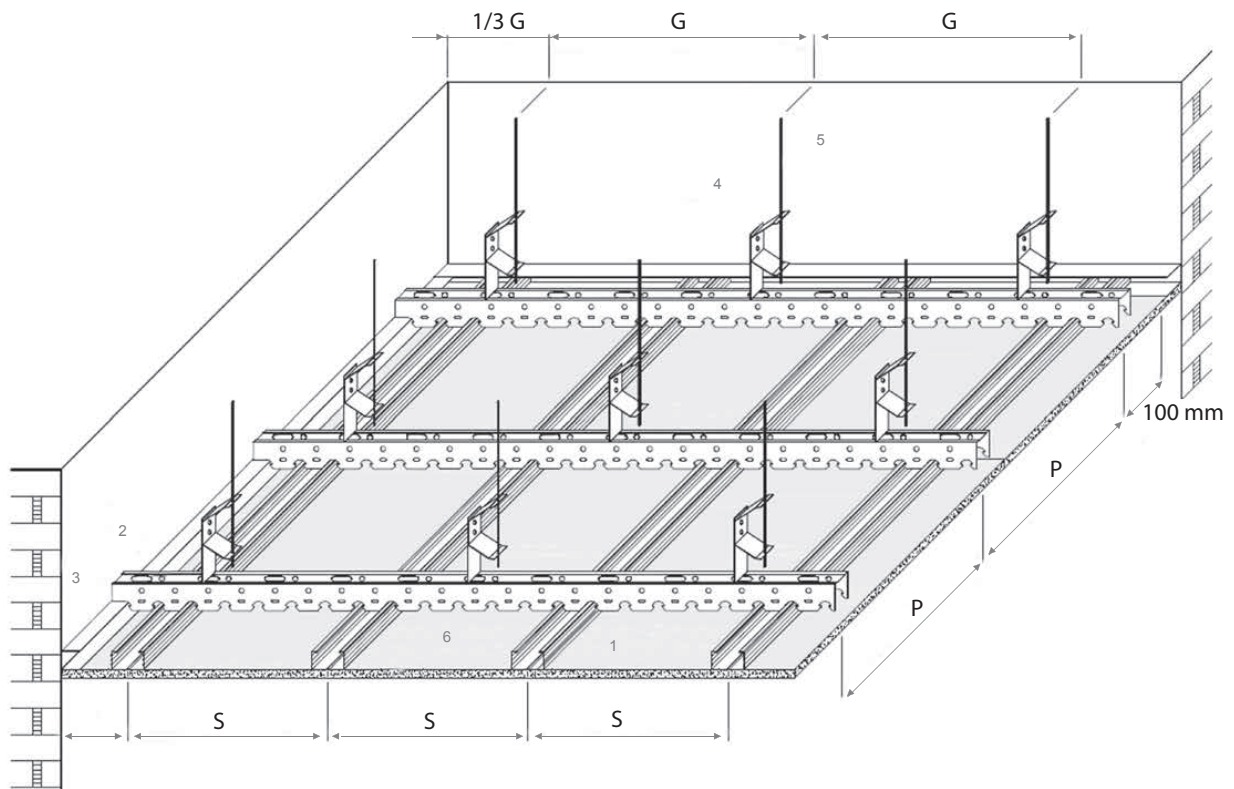

**HIMLINGENS  
TOTALE VEKT**  
(Kg/m<sup>2</sup>)

Mindre enn 10	1200
Mellom 10 og 15	900
Mellom 15 og 30	750
Mellom 30 og 50	600

**AVSTAND  
HENGERE - G**  
(mm)

1200
900
750
600

**HIMLINGENS  
TOTALE VEKT**  
(Kg/m<sup>2</sup>)

Mindre enn 15	1200
Mellom 15 og 30	1000
Mellom 30 og 50	750

**AVSTAND C/C  
PROFILER - P**  
(mm)





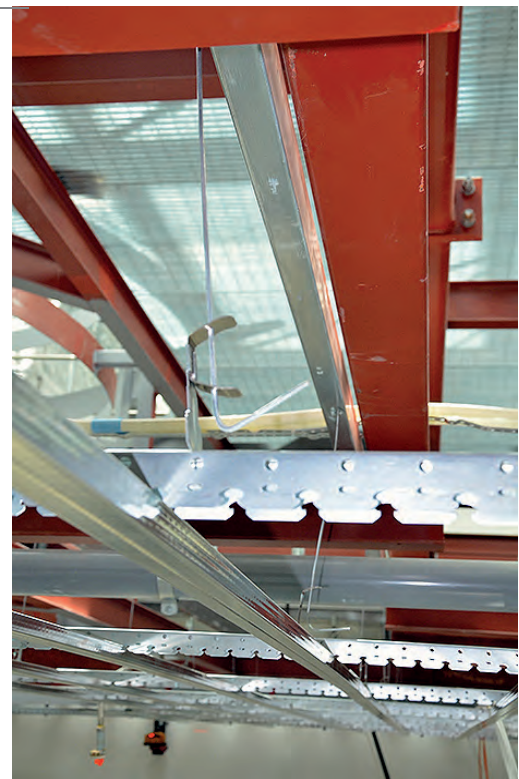

1200
1000
750

**c/c avstand på C-profil ut fra plateprodusentens anvisninger**

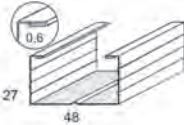
**Minste monteringshøyde till underkant profilen**

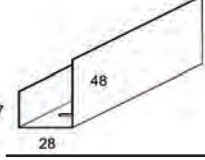
Med C.033 Justerbart feste	153 mm
Med direkte skrudd Merkur profil + C50	57 mm
KLIPSFESTE / C.056 klipsfeste monteres med hull for gjengestag M6	34 mm

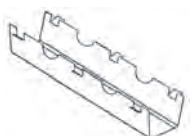
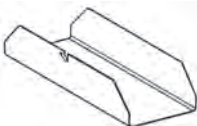
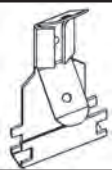
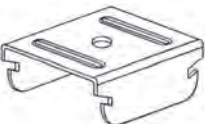

PROFIL	BENEVNELSE	BENEVNELSE	MÅL (mm)			CA MEDGÅR per kvm		
			Bredde	Høyde	Lengde	c/c avstand		
	Profil C 50 x 27 Ståltykkelse 0,6 mm Knekt kant Galvanisert	CD50276S	48	27	3000	c/c avstand		
	SORT	CD50276S NMAT				2,5	2,2	1,7 LM
	Merkur profil for profil C 50 x 27 CD50276S Ståltykkelse 0.7 mm	UD274007	27	40	3000	avhengig av vekt c/c 1200 10 kg 0,9 LM		
	Vegglist for profil C 50 x 27 Ståltykkelse 0.6 mm	UD284806	28	27/48	3000	utfra rommets omkrets		
	Justerbart feste for 4 mm pendel til Merkur UD274007	C.033	Antall pr kartong		100	ca 0,8 stk beror på c/c avstand bæreprofil		
	Skjøtestykke til Merkur UD274007	C.125	Antall pr kartong		100	ca 0,3 stk beror på c/c avstand bæreprofil		
	Skøtestykke til CD5027	C.009	Antall pr kartong		100	c/c avstand 400 450 600 0,8 0,7 0,5 stk		
	Justerbart feste for 4 mm pendel til CD5027	C.090	Antall pr kartong		100			
	Clipsfeste med gjenge hull MA6 til CD5027	C.056	Antall pr kartong		100			
	Pendel 4 mm Type 90 med krok	C.040 V	Lengde	HENGERE 125 MM	100	0,8 stk		
		C.017 V		HENGERE 250 MM	100			
		C.041 V		HENGERE 375 MM	100			
		C.018 V		HENGERE 500 MM	100			
		C.042.V		HENGERE 750 MM	100			
		C.019 V		HENGERE 1000 MM	100			
		C.043 V		HENGERE 1500 MM	100			
		C.044 V		HENGERE 2000 MM	100			
		C.140 V		HENGERE 2500 MM	50			
		C.138 V		HENGERE 3000 MM	50			
C.139 V		HENGERE 4000 MM	50					
	Justerbart direktefeste til C50 profil	C.131	Høyde	40 mm	100			
		C.130		60 mm	100			
		C.129		80 mm	100			
		C.126		120 mm	100			