

HUS3 Screw anchor

	Anchor version	Benefits
	HUS3-H 8 / 10 / 14 Carbon steel concrete screw with hexagonal head	<ul style="list-style-type: none"> - High productivity – less drilling and fewer operations than with conventional anchors - ETA approval for cracked and non-cracked concrete - ETA approval for adjustability (unscrew-rescrew) - Seismic approval ETA C1 - High loads - Small edge and spacing distances - abZ (DIBt) approval for reusability in fresh concrete ($f_{ck,cube}=10/15/20 \text{ Nmm}^2$) for temporary applications - Three embedment depths for maximum design flexibility - HUS3-HF with multilayer coatings for additional corrosion protection
	HUS3-C 8 / 10 Carbon steel concrete screw with countersunk head	
	HUS3-HF 10 / 14 Carbon steel concrete screw with multilayer coating ($\geq 14 \mu\text{m}$) and hexagonal head	



Concrete



Tensile zone



Solid brick



Autoclaved aerated concrete



Seismic
ETA-C1

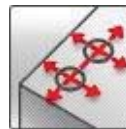

Small edge distance and spacing



Fire resistance



Sprinkler approved



European
Technical
Approval



CE
conformity



DIBt
Approval
Reusability



PROFIS
Anchor
design
software

Approvals / certificates

Description	Authority / Laboratory	No. / date of issue
European technical assessment ^{a)}	DIBt, Berlin	ETA-13/1038 / 2014-09-19
DIBt approval (Reusability)	DIBt, Berlin	Z-21.8-2018 / 2014-04-01

a) All data given in this section for HUS3-H and HUS3-C according ETA-13/1038, issue 2014-09-19.

Basic loading data (for a single anchor)

All data in this section applies to

- Correct setting (See setting instruction)
- No edge distance and spacing influence
- Steel failure
- Minimum base material thickness
- Cracked and non-cracked Concrete C 20/25, $f_{ck,cube} = 25 \text{ N/mm}^2$
- Adjustment allowed during the installation for size 8 and 10, types H, C and h_{nom2} only.

For details see Simplified design method

Mean ultimate resistance

		Data according ETA-13/1038, issue 2014-09-19.								
Anchor size		8			10			14		
Type	HUS3	H, C			H, C			H		
Nominal embedment depth	h_{nom} [mm]	50	60	70	55	75	85	65	85	115
Non-cracked concrete										
Tensile $N_{Ru,m}$	[kN]	11,9	15,9	21,2	15,9	26,6	36,8	23,2	36,2	59,0
Shear $V_{Ru,m}$	[kN]	17,0	17,9	17,9	18,0	29,4	29,4	46,4	47,3	47,3
Cracked concrete										
Tensile $N_{Ru,m}$	[kN]	8,0	11,9	15,9	12,8	21,4	26,3	16,5	25,8	42,0
Shear $V_{Ru,m}$	[kN]	12,1	17,9	17,9	12,8	29,4	29,4	33,1	47,3	47,3
		Hilti Tech. Data								
Anchor size		10			14					
Type	HUS3	HF			HF					
Nominal embedment depth	h_{nom} [mm]	55	75	85	65	85				
Non-cracked concrete										
Tensile $N_{Ru,m}$	[kN]	15,9	26,6	36,8	23,2	36,2				
Shear $V_{Ru,m}$	[kN]	18,0	25,7	25,7	46,4	47,3				
Cracked concrete										
Tensile $N_{Ru,m}$	[kN]	12,8	21,4	26,3	16,5	25,8				
Shear $V_{Ru,m}$	[kN]	12,8	25,7	25,7	33,1	47,3				

Characteristic resistance

		Data according ETA-13/1038, issue 2014-09-19.								
Anchor size		8			10			14		
Type	HUS3	H, C			H, C			H		
Nominal embedment depth	h_{nom} [mm]	50	60	70	55	75	85	65	85	115
Non-cracked concrete										
Tensile N_{Rk}	[kN]	9,0	12,0	16,0	12,0	20,0	27,8	17,5	27,3	44,4
Shear V_{Rk}	[kN]	12,8	17,0	17,0	13,5	28,0	28,0	35,0	45,0	45,0
Cracked concrete										
Tensile N_{Rk}	[kN]	6,0	9,0	12,0	9,7	16,1	19,8	12,5	19,4	31,7
Shear V_{Rk}	[kN]	9,1	17,0	17,0	9,7	28,0	28,0	24,9	38,9	45,0
		Hilti Tech. Data								
Anchor size		10			14					
Type	HUS3	HF			HF					
Nominal embedment depth	h_{nom} [mm]	55	75	85	65	85				
Non-cracked concrete										
Tensile N_{Rk}	[kN]	12,0	20,0	27,8	17,5	27,3				
Shear V_{Rk}	[kN]	13,5	24,5	24,5	35,0	45,0				
Cracked concrete										
Tensile N_{Rk}	[kN]	9,7	16,1	19,8	12,5	19,4				
Shear V_{Rk}	[kN]	9,7	24,5	24,5	24,9	38,9				

Design resistance

		Data according ETA-13/1038, issue 2014-09-19.								
Anchor size		8			10			14		
Type	HUS3	H, C			H, C			H		
Nominal embedment depth	h_{nom} [mm]	50	60	70	55	75	85	65	85	115
Non-cracked concrete										
Tensile N_{Rd}	[kN]	6,0	8,0	10,7	8,0	13,3	18,5	11,7	18,2	29,6
Shear V_{Rd}	[kN]	8,5	11,3	11,3	9,0	18,7	18,7	23,3	30,0	30,0
Cracked concrete										
Tensile N_{Rd}	[kN]	4,0	6,0	8,0	6,4	10,8	13,2	8,3	13,0	21,1
Shear V_{Rd}	[kN]	6,1	11,3	11,3	6,4	18,7	18,7	16,6	25,9	30,0
Hilti Tech. Data										
Anchor size		10			14					
Type	HUS3	HF			HF					
Nominal embedment depth	h_{nom} [mm]	55	75	85	65	85				
Non-cracked concrete										
Tensile N_{Rd}	[kN]	8,0	13,3	18,5	11,7	18,2				
Shear V_{Rd}	[kN]	9,0	16,3	16,3	23,3	30,0				
Cracked concrete										
Tensile N_{Rd}	[kN]	6,4	10,8	13,2	8,3	13,0				
Shear V_{Rd}	[kN]	6,4	16,3	16,3	16,6	25,9				

Recommended load

		Data according ETA-13/1038, 2014-09-19.								
Anchor size		8			10			14		
Type	HUS3	H, C			H, C			H		
Nominal embedment depth	h_{nom} [mm]	50	60	70	55	75	85	65	85	115
Non-cracked concrete										
Tensile N_{Rec}	[kN]	4,3	5,7	7,6	5,7	9,5	13,2	8,3	13,0	21,2
Shear V_{Rec}	[kN]	6,1	8,1	8,1	6,5	13,3	13,3	16,6	21,4	21,4
Cracked concrete										
Tensile N_{Rec}	[kN]	2,9	4,3	5,7	4,6	7,7	9,4	5,9	9,3	15,1
Shear V_{Rec}	[kN]	4,3	8,1	8,1	4,6	13,3	13,3	11,9	18,5	21,4
Hilti Tech. Data										
Anchor size		10			14					
Type	HUS3	HF			HF					
Nominal embedment depth	h_{nom} [mm]	55	75	85	65	85				
Non-cracked concrete										
Tensile N_{Rec}	[kN]	5,7	9,5	13,2	8,3	13,0				
Shear V_{Rec}	[kN]	6,5	11,7	11,7	16,6	21,4				
Cracked concrete										
Tensile N_{Rec}	[kN]	4,6	7,7	9,4	5,9	9,3				
Shear V_{Rec}	[kN]	4,6	11,7	11,7	11,9	18,5				

a) With overall partial safety factor for action $\gamma = 1,4$. The partial safety factors for action depend on the type of loading and shall be taken from national regulations.

Materials

Mechanical properties

Anchor size		8	10	10	14
Type	HUS3	H, C	H, C	HF	H, HF
Nominal tensile strength f_{uk}	[N/mm ²]	810	805	705	730
Yield strength f_{yk}	[N/mm ²]	695	690	605	630
Stressed cross-section A_s	[mm ²]	48,4	77,0	77,0	131,7
Moment of resistance W	[mm ³]	47	95	95	213
Char, bending resistance $M_{RK,S}^0$	[Nm]	46	92	81	187

Material quality

Type	Material	Coating
HUS3-H / HUS3-C	Carbon-steel	Galvanized ($\geq 5 \mu\text{m}$)
HUS3-HF	Carbon-steel	Multilayer coating ($\geq 14 \mu\text{m}$)

Anchor dimensions

Dimensions

Anchor size			8	10	14
Type			H, C	H, C, HF	H, HF
Threaded outer diameter	d_t	[mm]	10,30	12,40	16,85
Core diameter	d_k	[mm]	7,85	9,90	12,95
Shaft diameter	d_s	[mm]	8,45	10,55	13,80
Stressed section	A_s	[mm ²]	48,4	77,0	131,7

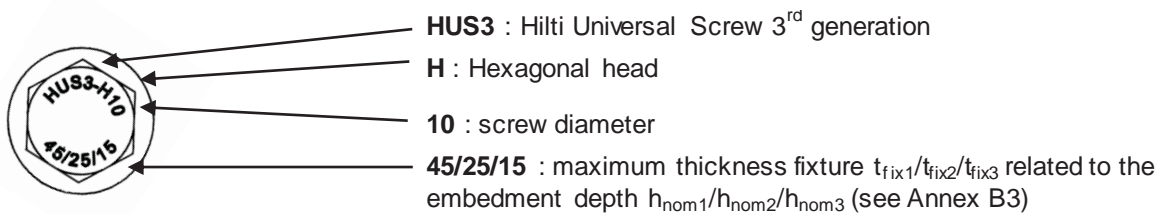
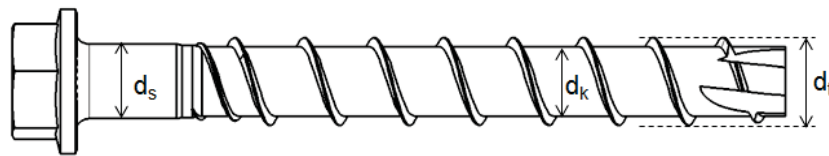

Screw length and thickness of fixture for HUS3-H (hex head, galvanized)

Anchor size	HUS3-H	8			10			14		
		h_{nom1} 50	h_{nom2} 60	h_{nom3} 70	h_{nom1} 55	h_{nom2} 75	h_{nom3} 85	h_{nom1} 65	h_{nom2} 85	h_{nom3} 115
Nominal anchorage depth [mm]	Length of anchor [mm]	Thickness of fixture [mm]								
		t_{fix1}	t_{fix2}	t_{fix3}	t_{fix1}	t_{fix2}	t_{fix3}	t_{fix1}	t_{fix2}	t_{fix3}
55	55	5	-	-	-	-	-	-	-	-
60	60	-	-	-	5	-	-	-	-	-
65	65	15	5	-	-	-	-	-	-	-
70	70	-	-	-	15	-	-	-	-	-
75	75	25	15	5	-	-	-	10	-	-
80	80	-	-	-	25	5	-	-	-	-
85	85	35	25	15	-	-	-	-	-	-
90	90	-	-	-	35	15	5	-	-	-
100	100	50	40	30	45	25	15	35	15	-
110	110	-	-	-	55	35	25	-	-	-
120	120	70	60	50	-	-	-	-	-	-
130	130	-	-	-	75	55	45	65	45	15
150	150	100	90	80	95	75	65	85	65	35

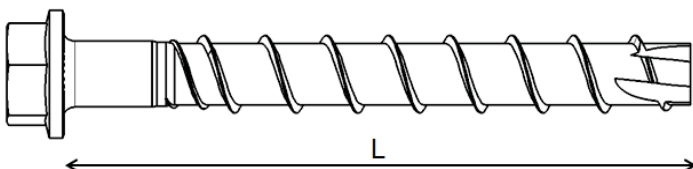

Screw length and thickness of fixture for HUS3-HF (hex head, multilayer coating)

Anchor size	HUS3-HF	10			14	
		h_{nom1}	h_{nom2}	h_{nom3}	h_{nom1}	h_{nom2}
Nominal anchorage depth [mm]		55	75	85	65	85
Length of anchor [mm]		Thickness of fixture [mm]				
		t_{fix1}	t_{fix2}	t_{fix3}	t_{fix1}	t_{fix2}
60		5	-	-	-	-
75		-	-	-	10	-
80		25	5	-	-	-
100		45	25	15	35	15
110		55	35	25	-	-

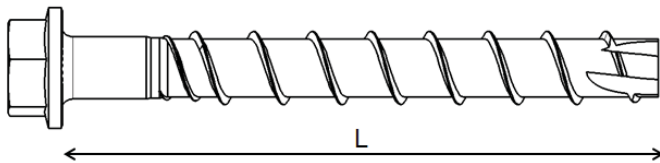

Screw length and thickness of fixture for HUS3-C (countersunk head, galvanized)

Anchor size	HUS3-C	8			10		
		h_{nom1}	h_{nom2}	h_{nom3}	h_{nom1}	h_{nom2}	h_{nom3}
Nominal anchorage depth [mm]		50	60	70	55	75	85
Length of anchor [mm]		Thickness of fixture [mm]					
		t_{fix1}	t_{fix2}	t_{fix3}	t_{fix1}	t_{fix2}	t_{fix3}
65		15	5	-	-	-	-
70		-	-	-	15	-	-
75		25	15	-	-	-	-
85		35	25	15	-	-	-
90		-	-	-	35	15	-
100		-	-	-	45	25	15

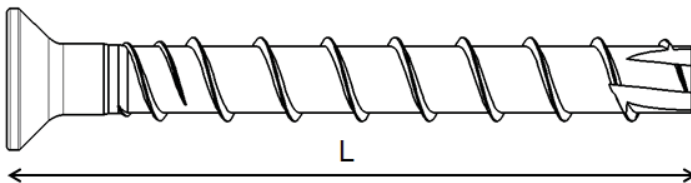

Setting

Installation equipment

Anchor size		8	10	14
Type	HUS3	H, C	H, C, HF	H, HF
Rotary hammer		TE 2 – TE 30	TE 2 – TE 30	TE 2 – TE 30
Drill bit for concrete, solid clay brick and solid sand-lime brick		CX 8	CX 10	CX 14
Drill bit for aerated concrete		CX 6	CX 8	-
Socket wrench insert		S-NSD 13 1/2	S-NSD 15 1/2	S-NSD 21 1/2
Torx		S-SY TX45	S-SY TX50	-
Tube for temporary application (only for H type)		HRG 8	HRG 10	HRG 14
Setting tool for concrete C12/15 to C50/60		SIW 22T-A		
Setting tool for solid brick and aerated concrete		SFH 22A		
Setting tool for hollow core slab		SIW 22 A		

Setting details for concrete

Anchor size		8			10			14		
Type	HUS3	H, C			H, C, HF			H, HF		H
Nominal anchorage depth	h_{nom} [mm]	50	60	70	55	75	85	65	85	115
Nominal diameter of drill bit	d_o [mm]	8			10			14		
Cutting diameter of drill bit	$d_{cut} \leq$ [mm]	8,45			10,45			14,50		
Depth of drill hole	$h_1 \geq$ [mm]	60	70	80	65	85	95	75	95	125
Diameter of clearance hole in the fixture	$d_f \leq$ [mm]	12			14			18		
Diameter of countersunk head	d_h [mm]	18			21			-		
Width across (H, HF types)	SW [mm]	13			15			21		
Torx (C type)	TX [-]	45			50			-		
Impact screw driver		Hilti SIW 22 T-A								

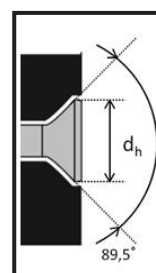
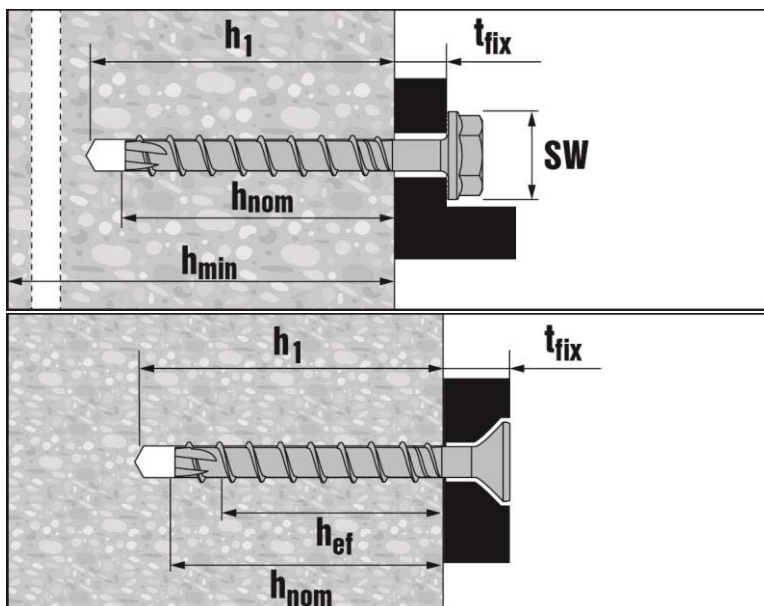

Setting instruction

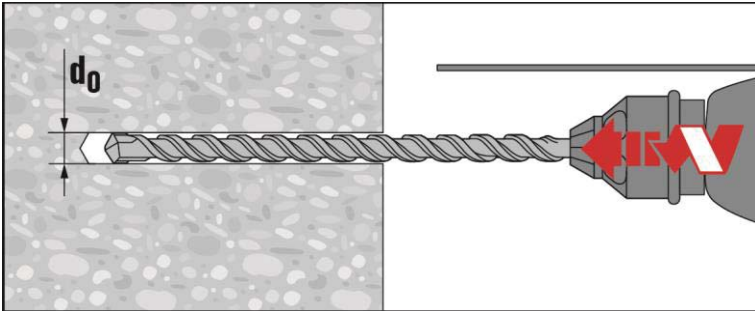

Make a cylindrical hole

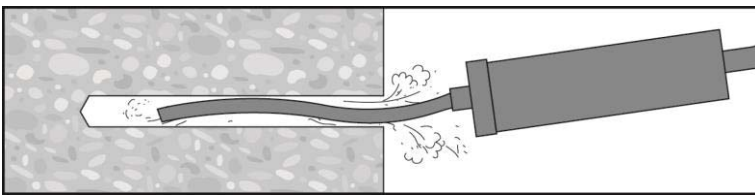

Clean the borehole

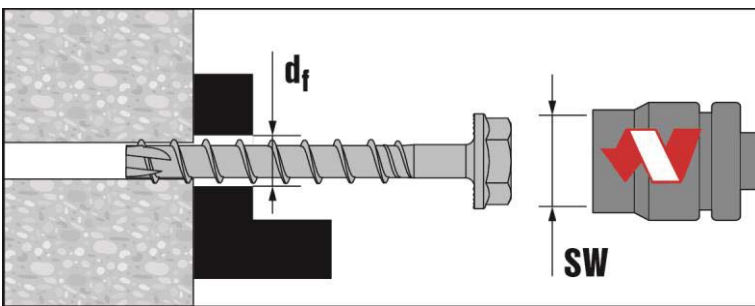

Install the screw anchor by impact screw driver Hilti SIW 22T-A

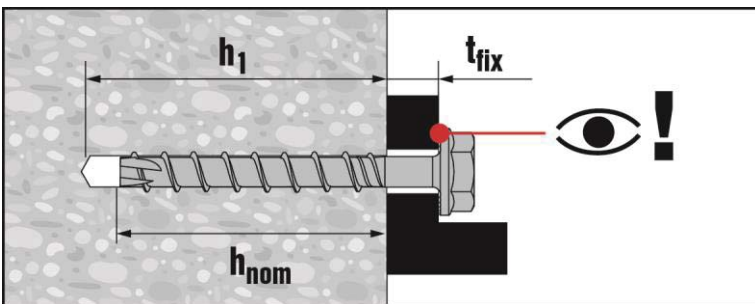

Ensure that the fixture is caught

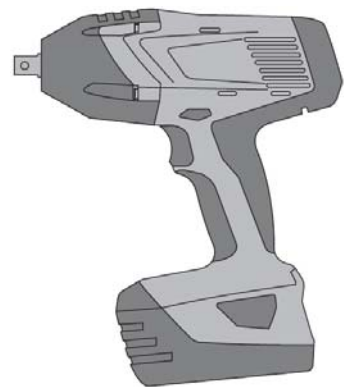

For detailed information on installation see instruction for use given with the package of the product.

**Setting instruction in case of adjustment process
(recommended for HUS3-H,C size 8 and 10 for standard embedment depth h_{nom2} only)**

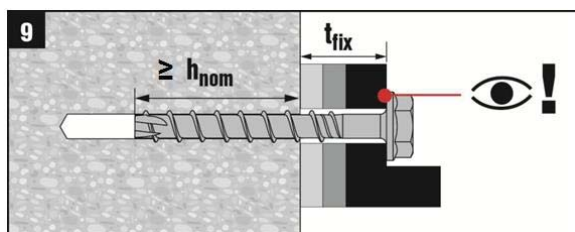
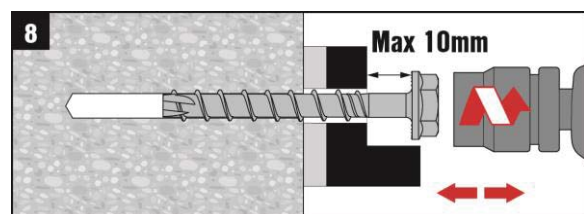
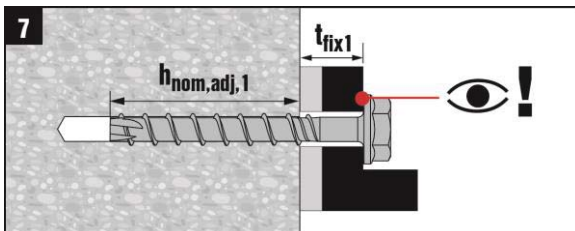
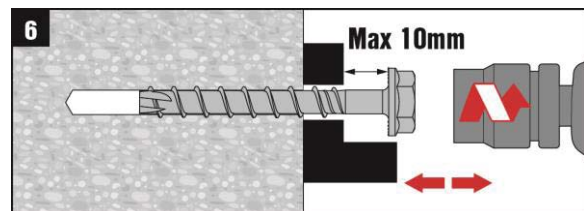
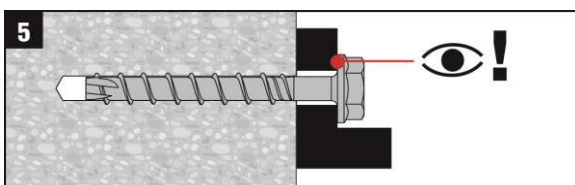
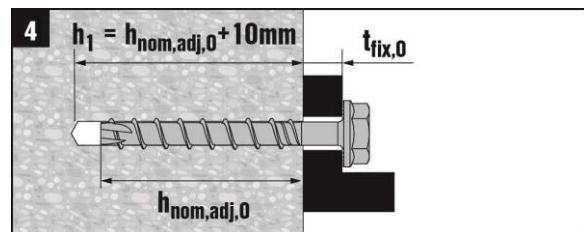
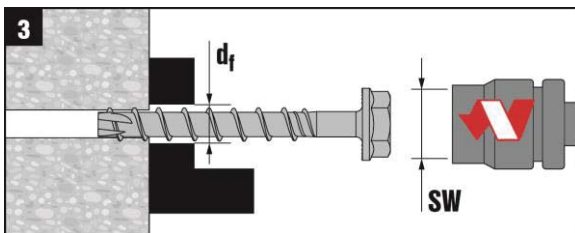
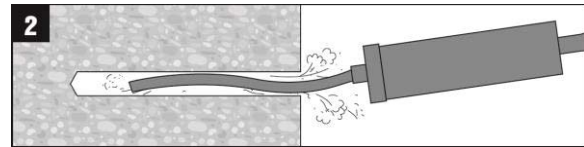
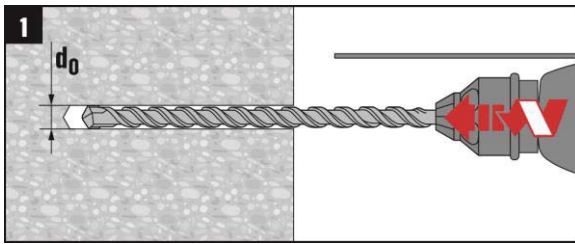

For setting HUS3-H,C 8 ($h_{nom2}=60\text{mm}$) and HUS3-H,C 10 ($h_{nom2}=75\text{mm}$) it is allowed to adjust (loosening max. 10mm and re-tightening) the screw. The adjustment can be done maximum two times, $n_a=2$. The final embedment depth after adjustment process must be larger or equal than h_{nom2} . The total allowed thickness of shims added during the adjustment process $t_{adj}=10\text{mm}$.

Design parameters

Anchor size		8			10			14		
Type	HUS3	H, C			H, C, HF			H, HF		H
Nominal anchorage depth	h_{nom} [mm]	50	60	70	55	75	85	65	85	115
Effective anchorage depth	h_{ef} [mm]	40	46,4	54,9	41,6	58,6	67,1	49,3	66,3	91,8
Minimum base material thickness	h_{min} [mm]	100	100	120	100	130	140	120	160	200
Minimum spacing	s_{min} [mm]	40	50	50	50	50	60	60	75	75
Minimum edge distance	c_{min} [mm]	50	50	50	50	50	60	60	75	75
Critical spacing for splitting failure	$s_{cr,sp}$ [mm]	120	140	170	130	180	220	170	200	280
Critical edge distance for splitting failure	$c_{cr,sp}$ [mm]	60	70	85	65	90	110	85	100	140
Critical spacing for concrete cone failure	$s_{cr,N}$ [mm]	120	140	170	130	180	202	150	200	280
Critical edge distance for concrete cone failure	$c_{cr,N}$ [mm]	60	70	85	65	90	101	75	100	140

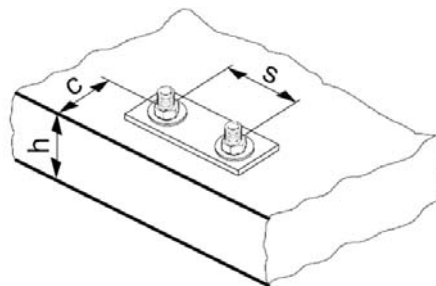

For spacing (edge distance) smaller than critical spacing (critical edge distance) the design loads have to be reduced.

Simplified design method

Simplified version of the design method according ETAG 001, Annex C. Design resistance according ETA-13/1038, issue 2014-03-26 (HUS3-H and C types only).

- Influence of concrete strength
- Influence of edge distance
- Influence of spacing
- Valid for a group of two anchors. (The method may also be applied for anchor groups with more than two anchors or more than one edge. The influencing factors must then be considered for each edge distance and spacing. The calculated design loads are then conservative: They will be lower than the exact values according ETAG 001, Annex C. To avoid this, it is recommended to use the anchor design software PROFIS anchor).

The design method is based on the following simplification:

- No different loads are acting on individual anchors (no eccentricity)

The values are valid for one anchor.

For more complex fastening applications please use the anchor design software PROFIS Anchor.

Tension loading

The design tensile resistance is the lower value of

- Steel resistance: $N_{Rd,s}$
- Concrete pull-out resistance: $N_{Rd,p} = N_{Rd,p}^0 \cdot f_B$
- Concrete cone resistance: $N_{Rd,c} = N_{Rd,c}^0 \cdot f_B \cdot f_{1,N} \cdot f_{2,N} \cdot f_{3,N} \cdot f_{re,N}$
- Concrete splitting resistance (only non-cracked concrete):
 $N_{Rd,sp} = N_{Rd,c}^0 \cdot f_B \cdot f_{1,sp} \cdot f_{2,sp} \cdot f_{3,sp} \cdot f_{h,sp} \cdot f_{re,N}$

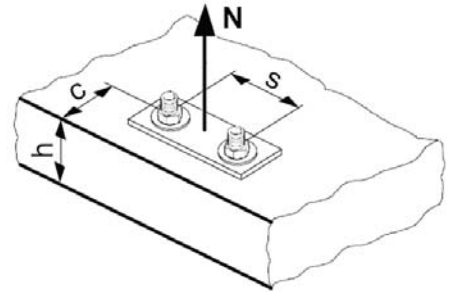

Basic design tensile resistance

Design steel resistance $N_{Rd,s}$

		Data according ETA-13/1038, 2014-09-19.		
Anchor size		8	10	14
Type	HUS3	H, C	H, C	H
$N_{Rd,s}$	[kN]	28,0	44,4	69,0
		Hilti Tech. Data		
Anchor size		10	14	
Type	HUS3	HF	HF	
$N_{Rd,s}$	[kN]	38,7	69,0	

Design pull-out resistance $N_{Rd,p} = N_{Rd,p}^0 \cdot f_B$

		Data according ETA-13/1038, 2014-09-19.								
Anchor size		8			10			14		
Type HUS3		H, C			H, C			H		
Nominal anchorage depth	h_{nom} [mm]	50	60	70	55	75	85	65	85	115
Non-cracked concrete										
$N_{Rd,p}^0$	[kN]	6,0	8,0	10,7	8,0	13,3	No pull-out	No pull-out		
Cracked concrete										
$N_{Rd,p}^0$	[kN]	4,0	6,0	8,0	No pull-out			No pull-out		
		Hilti Tech. Data								
Anchor size		10			14					
Type HUS3		HF			HF					
Nominal anchorage depth	h_{nom} [mm]	55	75	85	65	85				
Non-cracked concrete										
$N_{Rd,p}^0$	[kN]	8,0	13,3	No pull-out	No pull out					
Cracked concrete										
$N_{Rd,p}^0$	[kN]	No pull-out				No pull-out				

Design concrete cone resistance $N_{Rd,c} = N_{Rd,c}^0 \cdot f_B \cdot f_{1,N} \cdot f_{2,N} \cdot f_{3,N} \cdot f_{re,N}$

Design splitting resistance ^{a)} $N_{Rd,sp} = N_{Rd,c}^0 \cdot f_B \cdot f_{1,sp} \cdot f_{2,sp} \cdot f_{3,sp} \cdot f_{h,sp} \cdot f_{re,N}$

		Data according ETA-13/1038, 2014-09-19.								
Anchor size		8			10			14		
Type	HUS3	H, C			H, C			H		
Nominal anchorage depth	h_{nom} [mm]	50	60	70	55	75	85	65	85	115
Non-cracked concrete										
$N_{Rd,c}^0$	[kN]	8,5	10,6	13,7	9,0	15,1	18,5	11,7	18,2	29,6
Cracked concrete										
$N_{Rd,c}^0$	[kN]	6,1	7,6	9,8	6,4	10,8	13,2	8,3	13,0	21,1
		Hilti Tech. Data								
Anchor size		10			14					
Type	HUS3	HF			HF					
Nominal anchorage depth	h_{nom} [mm]	55	75	85	65	85				
Non-cracked concrete										
$N_{Rd,p}^0$	[kN]	9,0	15,1	18,5	11,7	18,2				
Cracked concrete										
$N_{Rd,p}^0$	[kN]	6,4	10,8	13,2	8,3	13,0				

Influencing factors

Influence of concrete strength

Concrete strength designation (ENV 206)	C 20/25	C 25/30	C 30/37	C 35/45	C 40/50	C 45/55	C 50/60
Pull-out , concrete cone and splitting resistance							
$f_B = (f_{ck,cube}/25N/mm^2)^{1/2}$ ^{a)}	1	1,1	1,22	1,34	1,41	1,48	1,55

a) $f_{ck,cube}$ = concrete compressive strength, measured on cubes with 150 mm side length.

Influence of edge distance ^{a)}

$c/c_{cr,N}$	0,1	0,2	0,3	0,4	0,5	0,6	0,7	0,8	0,9	1
$c/c_{cr,sp}$										
$f_{1,N} = 0,7 + 0,3 \cdot c/c_{cr,N} \leq 1$	0,73	0,76	0,79	0,82	0,85	0,88	0,91	0,94	0,97	1
$f_{1,sp} = 0,7 + 0,3 \cdot c/c_{cr,sp} \leq 1$										
$f_{2,N} = 0,5 \cdot (1 + c/c_{cr,N}) \leq 1$	0,55	0,60	0,65	0,70	0,75	0,80	0,85	0,90	0,95	1
$f_{2,sp} = 0,5 \cdot (1 + c/c_{cr,sp}) \leq 1$										

a) The edge distance shall not be smaller than the minimum edge distance c_{min} given in the table with the setting details, These influencing factors must be considered for every edge distance.

Influence of anchor spacing ^{a)}

$s/s_{cr,N}$	0,1	0,2	0,3	0,4	0,5	0,6	0,7	0,8	0,9	1
$s/s_{cr,sp}$										
$f_{3,N} = 0,5 \cdot (1 + s/s_{cr,N}) \leq 1$										
$f_{3,sp} = 0,5 \cdot (1 + s/s_{cr,sp}) \leq 1$	0,55	0,60	0,65	0,70	0,75	0,80	0,85	0,90	0,95	1

a) The anchor spacing shall not be smaller than the minimum anchor spacing s_{min} given in the table with the setting details. This influencing factor must be considered for every anchor spacing.

Influence of base material thickness

h/h_{min}	1,0	1,1	1,2	1,3	1,4	1,5	1,6	1,7	1,8	$\geq 1,84$
$f_{h,sp} = [h/(h_{min})]^{2/3}$	1	1,07	1,13	1,19	1,25	1,31	1,37	1,42	1,48	1,5

Influence of reinforcement ^{a)}

Anchor size		8			10			14		
Type	HUS3	H, C, HF			H, C, HF			H, HF		
Nominal anchorage depth	h_{nom} [mm]	50	60	70	55	75	85	65	85	115
$f_{re,N} = 0,5 + h_{ef}/200mm \leq 1$		0,70	0,73	0,77	0,71	0,79	0,84	0,75	0,83	0,96

d) This factor applies only for dense reinforcement, If in the area of anchorage there is reinforcement with a spacing ≥ 150 mm (any diameter) or with a diameter ≤ 10 mm and a spacing ≥ 100 mm, then a factor $f_{re,N} = 1$ may be applied.

Shear loading

The design shear resistance is the lower value of

- Steel resistance: $V_{Rd,s}$
- Concrete pryout resistance: $V_{Rd,cp} = k \cdot N_{Rd,c}$
- Concrete edge resistance: $V_{Rd,c} = V_{Rd,c}^0 \cdot f_B \cdot f_{\beta} \cdot f_h \cdot f_4 \cdot f_{hef} \cdot f_c$

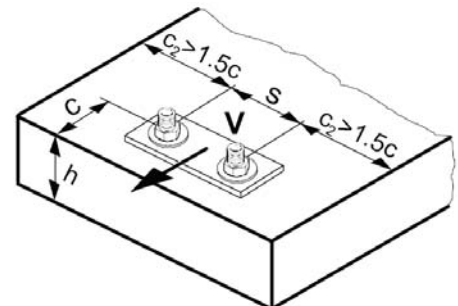

Basic design shear resistance

Design steel resistance $V_{Rd,s}$

		Data according ETA-13/1038, issue 2014-09-19.		
Anchor size		8	10	14
Type	HUS3	H, C	H, C	H,
$V_{Rd,s}$	[kN]	11,3	18,7	30,0
		Hilti Tech. Data		
Anchor size		10	14	
Type	HUS3	HF	HF	
$V_{Rd,s}$	[kN]	16,3	30,0	

Design concrete pry-out resistance $V_{Rd,cp} = k \cdot N_{Rd,c}$ ^{a)}

		Data according ETA-13/1038, issue 2014-09-19.								
Anchor size		8			10			14		
Type		H, C			H, C, HF			H, HF		H
Nominal anchorage depth	h_{nom} [mm]	50	60	70	55	75	85	65	85	115
k		1,0	2,0	2,0	1,0	2,0	2,0	2,0	2,0	2,0
		Hilti Tech. Data								
Anchor size		10			14					
Type	HUS3	HF			HF					
Nominal anchorage depth	h_{nom} [mm]	55	75	85	65	85				
k	[kN]	1,0	2,0	2,0	2,0	2,0				

a) $N_{Rd,c}$: Design concrete cone resistance

Design concrete edge resistance $a) V_{Rd,c} = V_{Rd,c}^0 \cdot f_B \cdot f_{\beta} \cdot f_h \cdot f_4 \cdot f_{hef} \cdot f_c$

Data according ETA-13/1038, issue 2014-09-19.										
Anchor size	8			10			14			
Type	H, C			H, C			H			
Nominal anchorage depth h_{nom} [mm]	50	60	70	55	75	85	65	85	115	
Non-cracked concrete										
$V_{Rd,c}^0$ [kN]	6,0	6,0	6,0	8,6	8,6	8,6	15,0	15,1	15,2	
Cracked concrete										
$V_{Rd,c}^0$ [kN]	4,2	4,2	4,2	6,1	6,1	6,1	10,6	10,7	10,7	
Hilti Tech. Data										
Anchor size	10			14						
Type	HF			HF						
Nominal anchorage depth h_{nom} [mm]	55	75	85	65	85					
Non-cracked concrete										
$V_{Rd,c}^0$ [kN]	8,6	8,6	8,6	15,0	15,1					
Cracked concrete										
$V_{Rd,c}^0$ [kN]	6,1	6,1	6,1	10,6	10,7					

c) For anchor groups only the anchors close to the edge must be considered.

Influencing factors

Influence of concrete strength

Concrete strength designation (ENV 206)	C 20/25	C 25/30	C 30/37	C 35/45	C 40/50	C 45/55	C 50/60
$f_B = (f_{ck,cube}/25N/mm^2)^{1/2}$ a)	1	1,1	1,22	1,34	1,41	1,48	1,55

a) $f_{ck,cube}$ = concrete compressive strength, measured on cubes with 150 mm side length.

Influence of angle between load applied and the direction perpendicular to the free edge

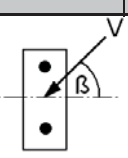
Angle β	0°	10°	20°	30°	40°	50°	60°	70°	80°	≥ 90°
$f_{\beta} = \sqrt{\frac{1}{(\cos \alpha_V)^2 + \left(\frac{\sin \alpha_V}{2,5}\right)^2}}$ 	1	1,01	1,05	1,13	1,24	1,40	1,64	1,97	2,32	2,50

Influence of base material thickness

h/c	0,15	0,3	0,45	0,6	0,75	0,9	1,05	1,2	1,35	≥ 1,5
$f_h = \{h/(1,5 \cdot c)\}^{1/2} \leq 1$	0,32	0,45	0,55	0,63	0,71	0,77	0,84	0,89	0,95	1,00

Influence of anchor spacing and edge distance ^{a)} for concrete edge resistance: f_4
 $f_4 = (c/h_{ef})^{1,5} \cdot (1 + s / [3 \cdot c]) \cdot 0,5$

c/h _{ef}	Single anchor	Group of two anchors s/h _{ef}														
		0,75	1,50	2,25	3,00	3,75	4,50	5,25	6,00	6,75	7,50	8,25	9,00	9,75	10,50	11,25
0,50	0,35	0,27	0,35	0,35	0,35	0,35	0,35	0,35	0,35	0,35	0,35	0,35	0,35	0,35	0,35	0,35
0,75	0,65	0,43	0,54	0,65	0,65	0,65	0,65	0,65	0,65	0,65	0,65	0,65	0,65	0,65	0,65	0,65
1,00	1,00	0,63	0,75	0,88	1,00	1,00	1,00	1,00	1,00	1,00	1,00	1,00	1,00	1,00	1,00	1,00
1,25	1,40	0,84	0,98	1,12	1,26	1,40	1,40	1,40	1,40	1,40	1,40	1,40	1,40	1,40	1,40	1,40
1,50	1,84	1,07	1,22	1,38	1,53	1,68	1,84	1,84	1,84	1,84	1,84	1,84	1,84	1,84	1,84	1,84
1,75	2,32	1,32	1,49	1,65	1,82	1,98	2,15	2,32	2,32	2,32	2,32	2,32	2,32	2,32	2,32	2,32
2,00	2,83	1,59	1,77	1,94	2,12	2,30	2,47	2,65	2,83	2,83	2,83	2,83	2,83	2,83	2,83	2,83
2,25	3,38	1,88	2,06	2,25	2,44	2,63	2,81	3,00	3,19	3,38	3,38	3,38	3,38	3,38	3,38	3,38
2,50	3,95	2,17	2,37	2,57	2,77	2,96	3,16	3,36	3,56	3,76	3,95	3,95	3,95	3,95	3,95	3,95
2,75	4,56	2,49	2,69	2,90	3,11	3,32	3,52	3,73	3,94	4,15	4,35	4,56	4,56	4,56	4,56	4,56
3,00	5,20	2,81	3,03	3,25	3,46	3,68	3,90	4,11	4,33	4,55	4,76	4,98	5,20	5,20	5,20	5,20
3,25	5,86	3,15	3,38	3,61	3,83	4,06	4,28	4,51	4,73	4,96	5,18	5,41	5,63	5,86	5,86	5,86
3,50	6,55	3,51	3,74	3,98	4,21	4,44	4,68	4,91	5,14	5,38	5,61	5,85	6,08	6,31	6,55	6,55
3,75	7,26	3,87	4,12	4,36	4,60	4,84	5,08	5,33	5,57	5,81	6,05	6,29	6,54	6,78	7,02	7,26
4,00	8,00	4,25	4,50	4,75	5,00	5,25	5,50	5,75	6,00	6,25	6,50	6,75	7,00	7,25	7,50	7,75
4,25	8,76	4,64	4,90	5,15	5,41	5,67	5,93	6,18	6,44	6,70	6,96	7,22	7,47	7,73	7,99	8,25
4,50	9,55	5,04	5,30	5,57	5,83	6,10	6,36	6,63	6,89	7,16	7,42	7,69	7,95	8,22	8,49	8,75
4,75	10,35	5,45	5,72	5,99	6,27	6,54	6,81	7,08	7,36	7,63	7,90	8,17	8,45	8,72	8,99	9,26
5,00	11,18	5,87	6,15	6,43	6,71	6,99	7,27	7,55	7,83	8,11	8,39	8,66	8,94	9,22	9,50	9,78
5,25	12,03	6,30	6,59	6,87	7,16	7,45	7,73	8,02	8,31	8,59	8,88	9,17	9,45	9,74	10,02	10,31
5,50	12,90	6,74	7,04	7,33	7,62	7,92	8,21	8,50	8,79	9,09	9,38	9,67	9,97	10,26	10,55	10,85

a) The anchor spacing and the edge distance shall not be smaller than the minimum anchor spacing s_{min} and the minimum edge distance c_{min} .

Influence of embedment depth

Anchor size		8			10			14		
Type	HUS3	H, C			H, C, HF			H, HF		H
Nominal anchorage depth	h_{nom} [mm]	50	60	70	55	75	85	65	85	115
$f_{hef} = 0,05 \cdot (h_{ef} / d)^{1,68}$		0,75	0,96	1,27	0,55	0,98	1,22	0,41	0,68	1,18

Influence of edge distance ^{a)}

c/d	4	6	8	10	15	20	30	40
$f_c = (d / c)^{0,19}$	0,77	0,71	0,67	0,65	0,60	0,57	0,52	0,50

a) The edge distance shall not be smaller than the minimum edge distance c_{min} .

Precalculated values

Design resistance calculated according ETAG 001, Annex C and data given in ETA-13/1038 issue 2014-09-19.
All data applies to concrete C 20/25 – $f_{ck,cube} = 25 \text{ N/mm}^2$.

Design resistance

Single anchor, no edge effects

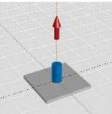
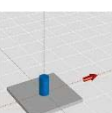
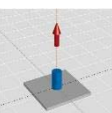
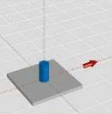
		Data according ETA-13/1038, issue 2014-03-26.								
Anchor size		8			10			14		
Type		H, C			H, C			H		
Nominal anchorage depth	h_{nom} [mm]	50	60	70	55	75	85	65	85	115
Min, base material thickness	h_{min} [mm]	100	100	120	100	130	140	120	160	200
	Tensile N_{Rd}									
	Non-cracked concrete									
	[kN]	6,0	8,0	10,7	8,0	13,3	18,5	11,7	18,2	29,6
	Cracked concrete									
	[kN]	4,0	6,0	8,0	6,4	10,8	13,2	8,3	13,0	21,1
	Shear V_{Rd}, without lever arm									
Non-cracked concrete										
[kN]	8,5	11,3	11,3	9,0	18,7	18,7	23,3	30,0	30,0	
Cracked concrete										
[kN]	6,1	11,3	11,3	6,4	18,7	18,7	16,6	25,9	30,0	
		Hilti Tech. Data								
Anchor size		10			14					
Type		HF			HF					
Nominal anchorage depth	h_{nom} [mm]	55	75	85	65	85				
Min, base material thickness	h_{min} [mm]	100	100	100	130	140				
	Tensile N_{Rd}									
	Non-cracked concrete									
	[kN]	8,0	13,3	18,5	11,7	18,2				
Cracked concrete										
[kN]	6,4	10,8	13,2	8,3	13,0					
	Shear V_{Rd}, without lever arm									
	Non-cracked concrete									
	[kN]	9,0	16,3	16,3	23,3	30,0				
Cracked concrete										
[kN]	6,4	16,3	16,3	16,6	25,9					

Single anchor, min. edge distance ($c = c_{min}$)

		Data according ETA-13/1038, issue 2014-09-19.								
Anchor size		8			10			14		
Type	HUS3	H, C			H, C			H		
Nominal anchorage depth	h_{nom} [mm]	50	60	70	55	75	85	65	85	115
Min. base material thickness	h_{min} [mm]	100	100	120	100	130	140	120	160	200
Min. edge distance	c_{min} [mm]	50	50	50	50	50	60	60	75	75
	Tensile N_{Rd}									
	Non-cracked concrete									
	[kN]	6,0	8,0	9,5	7,4	10,2	12,3	9,1	14,7	19,6
	Cracked concrete									
[kN]	4,0	5,9	6,8	5,3	7,3	8,8	6,5	10,5	14,0	
	Shear V_{Rd}, without lever arm									
	Non-cracked concrete									
	[kN]	4,4	4,5	4,6	4,6	4,9	6,4	6,3	9,0	9,6
	Cracked concrete									
[kN]	3,1	3,2	3,3	3,2	3,5	4,5	4,5	6,4	6,8	
		Hilti Tech. Data								
Anchor size		10			14					
Type	HUS3	HF			HF					
Nominal anchorage depth	h_{nom} [mm]	55	75	85	65	85				
Min. base material thickness	h_{min} [mm]	100	100	100	130	140				
Min. edge distance	c_{min} [mm]	50	50	60	60	75				
	Tensile N_{Rd}									
	Non-cracked concrete									
	[kN]	7,4	10,2	12,3	9,1	14,7				
	Cracked concrete									
[kN]	5,3	7,3	8,8	6,5	10,5					
	Shear V_{Rd}, without lever arm									
	Non-cracked concrete									
	[kN]	4,6	4,9	6,4	6,3	9,0				
	Cracked concrete									
[kN]	3,2	3,5	4,5	4,5	6,4					

Double anchor, no edge effects, min. spacing ($s = s_{min}$),
(load values are valid for one anchor)

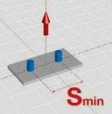
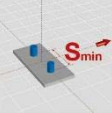
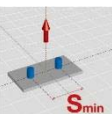
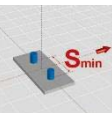
		Data according ETA-13/1038, issue 2014-09-19.								
Anchor size		8			10			14		
Type HUS3		H, C			H, C			H		
Nominal anchorage depth	h_{nom} [mm]	50	60	70	55	75	85	65	85	115
Min. base material thickness	h_{min} [mm]	100	100	120	100	130	140	120	160	200
Min. spacing	s_{min} [mm]	40	50	50	50	50	60	60	75	75
		Tensile N_{Rd}								
		Non-cracked concrete								
	[kN]	5,7	7,2	8,9	6,3	9,6	11,8	7,9	12,5	18,8
		Cracked concrete								
	[kN]	4,0	5,1	6,3	4,5	6,9	8,4	5,6	8,9	13,4
		Shear V_{Rd}, without lever arm								
		Non-cracked concrete								
	[kN]	5,7	11,3	11,3	6,3	18,7	18,7	16,4	25,0	30,0
		Cracked concrete								
	[kN]	4,0	10,3	11,3	4,5	13,8	17,1	11,7	17,8	26,9
		Hilti Tech. Data								
Anchor size		10			14					
Type HUS3		HF			HF					
Nominal anchorage depth	h_{nom} [mm]	55	75	85	65	85				
Min. base material thickness	h_{min} [mm]	100	100	100	130	140				
Min. spacing	s_{min} [mm]	50	50	60	60	75				
		Tensile N_{Rd}								
		Non-cracked concrete								
	[kN]	6,3	9,6	11,8	7,9	12,5				
		Cracked concrete								
	[kN]	4,5	6,9	8,4	5,6	8,9				
		Shear V_{Rd}, without lever arm								
		Non-cracked concrete								
	[kN]	6,3	16,3	16,3	16,4	25,0				
		Cracked concrete								
	[kN]	4,5	13,8	16,3	11,7	17,8				

Fire resistance

Basic loading data for concrete C20/25 – C50/60

All data in this section applies to:

- Correct setting (see setting instruction)
- No edge distance and spacing influence
- Minimum base material thickness
- HUS3-H only.

The following technical data are based on: ETA-13/1038 issue 2014-09-19.

Recommended loads under fire exposure

Anchor size	HUS3 H	8			10			14		
		h_{nom1}	h_{nom2}	h_{nom3}	h_{nom1}	h_{nom2}	h_{nom3}	h_{nom1}	h_{nom2}	h_{nom3}
Nominal embedment depth	h_{nom} [mm]	50	60	70	55	75	85	65	85	115
Steel failure for tension and shear load ($F_{Rec,s,fi} = N_{Rec,s,fi} = V_{Rec,s,fi}$)										
Recommended tensile and shear load	R30 $F_{Rec,s,fi}$ [kN]	2,3	2,5	2,7	4,4	4,4	7,4	7,6		
	R60 $F_{Rec,s,fi}$ [kN]	1,7	1,9	2,0	3,3	3,4	5,6	5,8		
	R90 $F_{Rec,s,fi}$ [kN]	1,1	1,1	1,4	2,2	2,3	3,8	3,9		
	R120 $F_{Rec,s,fi}$ [kN]	0,9	0,9	1,1	1,7	1,8	2,9	3,1		
	R30 $M^0_{Rec,s,fi}$ [Nm]	10,4	11,4	12,3	25,1	25,4	56,4	57,0		
	R60 $M^0_{Rec,s,fi}$ [Nm]	7,9	8,4	9,3	19,0	19,4	42,6	43,4		
	R90 $M^0_{Rec,s,fi}$ [Nm]	5,3	5,3	6,3	12,9	13,3	28,7	29,8		
	R120 $M^0_{Rec,s,fi}$ [Nm]	4,1	3,8	4,9	9,8	10,3	21,9	22,9		
Pull-out failure										
Recommended resistance	R30 R60 R90 $N_{Rec,p,fi}$ [kN]	1,1	1,6	2,1	1,7	2,9	3,5	2,2	3,4	5,6
	R120 $N_{Rec,p,fi}$ [kN]	0,9	1,3	1,7	1,4	2,3	2,8	1,8	2,7	4,5
Concrete cone failure										
Characteristic resistance	R30 R60 R90 $N^0_{Rec,c,fi}$ [kN]	1,3	1,9	2,9	1,4	3,4	4,7	2,1	4,6	10,3
	R120 $N^0_{Rec,c,fi}$ [kN]	1,0	1,5	2,3	1,1	2,7	3,8	1,7	3,6	8,2
Edge distance										
R30 to R120	$c_{Cr,N}$ [mm]	2 h_{ef}								
Anchor spacing										
R30 to R120	$s_{Cr,N}$ [mm]	4 h_{ef}								
Concrete pry-out failure										
R30 to R120	k [-]	1,0	2,0	1,0	2,0					

a) The recommended loads under fire exposure include a safety factor for resistance under fire exposure $\gamma_{M,fi} = 1,0$ and the partial safety factor for action $\gamma_{F,fi} = 1,0$. The partial safety factors for action shall be taken from national regulations.

Seismic design

Basic loading data for concrete C20/25 – C50/60

All data in this section applies to:

- Seismic design according to TR045
- HUS3-H and HUS3-C only

The following technical data are based on: ETA-13/1038 issue 2014-09-19.

Anchorage depth range

Anchor size		8	10	14
Type	HUS3	H, C	H, C	H
Nominal anchorage depth range	h_{nom} [mm]	70	85	115

Tension resistance in case of seismic performance category C1

Anchor size		8	10	14
Type	HUS3	H, C	H, C	H
Characteristic tension resistance to steel failure				
	$N_{Rk,s,seis}$ [kN]	39,2	62,2	96,6
Partial safety factor	$\gamma_{Ms,seis}$ [-]	1,4		
Characteristic pull-out resistance in cracked concrete C20/25 to C50/60				
	$N_{Rk,p,seis}$ [kN]	12	19,8	31,7
Partial safety factor	$\gamma_{Mp,seis}$ [-]	1,5		
Concrete cone resistance and splitting resistance				
Partial safety factor	$\gamma_{Mc,seis} = \gamma_{Msp,seis}$ [-]	1,5		

Displacement under tension load in case of seismic performance category C1 ¹⁾

Anchor size		8	10	14
Type	HUS3	H, C	H, C	H
Displacement	$\delta_{N,seis}$ [mm]	0,6	0,9	1,3

1) Maximum displacement during cycling (seismic event).

Shear resistance in case of seismic performance category C1 ¹⁾

Anchor size		8	10	14
Type	HUS3	H, C	H, C	H
Characteristic shear resistance to steel failure				
	$V_{Rk,s,seis}$ [kN]	11,9	16,8	22,5
Partial safety factor	$\gamma_{Ms,seis}$ [-]	1,5		
Concrete pryout resistance and concrete edge resistance				
Partial safety factor	$\gamma_{Mc,seis}$ [-]	1,5		

1) Reduction factor $\alpha_{gap} = 1,0$ when using the Hilti Dynamic Set

Displacement under tension load in case of seismic performance category C1 ¹⁾

Anchor size		8	10	14
Type	HUS3	H, C	H, C	H
Displacement	$\delta_{V,seis}$ [mm]	5,3	4,3	5,5

1) Maximum displacement during cycling (seismic event)

Basic loading data for temporary application in standard and fresh concrete < 28 days old, $f_{ck,cube} \geq 10 \text{ N/mm}^2$:

All data in this section applies to the following conditions:

- Strength class, $f_{ck,cube} \geq 10 \text{ N/mm}^2$
- Only temporary use
- Screw is reusable, before each usage it must be checked according Hilti instruction for use with the suited tube Hilti HRG
- Design resistance and recommended load are valid for single anchor only
- Design resistance as well as the recommended load are valid for all load direction and valid for both cracked and non-cracked concrete
- Minimum base material thickness
- No edge distance and spacing influence
- Valid for HUS3-H only.

a) All data given in this section for HUS3-H sizes 10 and 14 according DIBt approval Z-21.8-2018 issue 2014-04-01

Design resistance

		Hilti Tech. Data			DIBt approval Z-21.8-2018					
Anchor size	HUS3-H	8			10			14		
Nominal embedment depth	h_{nom} [mm]	50	60	70	55	75	85	65	85	115
Cracked and non-cracked concrete										
Tensile $N_{Rd} = \text{Shear } V_{Rd}$										
	$f_{ck,cube} \geq 10 \text{ N/mm}^2$ [kN]	2,5	3,2	4,7	3,3	5,3	6,3	4,4	7,0	12,3
	$f_{ck,cube} \geq 15 \text{ N/mm}^2$ [kN]	3,1	4,0	5,7	4,0	6,4	7,8	5,4	8,5	15,0
	$f_{ck,cube} \geq 20 \text{ N/mm}^2$ [kN]	3,6	4,6	6,6	4,7	7,4	9,0	6,2	9,9	17,3

Recommended load

		Hilti Tech. Data			DIBt approval Z-21.8-2018					
Anchor size	HUS3-H	8			10			14		
Nominal embedment depth	h_{nom} [mm]	50	60	70	55	75	85	65	85	115
Tensile $N_{rec} = \text{Shear } V_{rec}$										
	$f_{ck,cube} \geq 10 \text{ N/mm}^2$ [kN]	1,8	2,3	3,4	2,4	3,8	4,5	3,1	5,0	8,8
	$f_{ck,cube} \geq 15 \text{ N/mm}^2$ [kN]	2,2	2,9	4,1	2,9	4,6	5,5	3,8	6,1	10,7
	$f_{ck,cube} \geq 20 \text{ N/mm}^2$ [kN]	2,6	3,3	4,7	3,3	5,3	6,4	4,4	7,1	12,4

a) With overall partial safety factor for action $\gamma = 1,4$. The partial safety factors for action depend on the type of loading and shall be taken from national regulations.

Setting details

			Hilti			DIBt approval Z-21.8-2018					
Anchor size		HUS3-H	8			10			14		
Nominal anchorage depth	h_{nom}	[mm]	50	60	70	55	75	85	65	85	115
Minimum base material thickness	h_{min}	[mm]	100	115	145	115	150	175	130	175	255
Minimum spacing	s_{min}	[mm]	180	225	285	225	300	345	255	345	510
Minimum edge distance direction 1	c_1	[mm]	60	75	95	75	100	115	85	115	170
Minimum edge distance direction 2	c_2	[mm]	95	115	145	115	150	175	130	180	260

Setting details

			Hilti			DIBt approval Z-21.8-2018					
Anchor size		HUS3-H	8			10			14		
Nominal anchorage depth	h_{nom}	[mm]	50	60	70	55	75	85	65	85	115
Nominal diameter of drill bit	d_o	[mm]	8			10			14		
Cutting diameter of drill bit	$d_{cut} \leq$	[mm]	8,45			10,45			14,50		
Depth of drill bit	$h_1 \leq$	[mm]	60	70	80	65	85	95	75	95	125
Diameter of clearance hole in the fixture	$d_f \leq$	[mm]	12			14			18		
Width across	SW	[mm]	13			15			21		
Impact screw driver	Hilti SIW 22 T-A										
Suited tube	Hilti HRG 8			Hilti HRG 10			Hilti HRG 14				

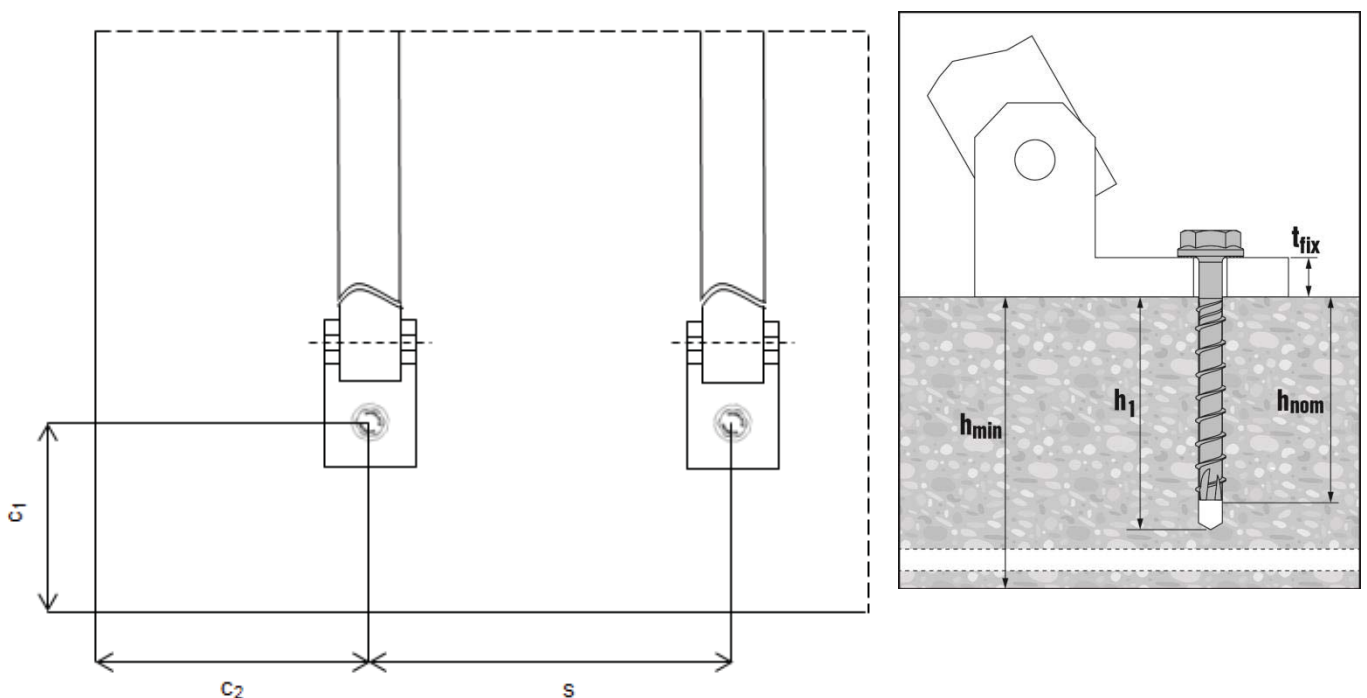

Tube specification

Anchor size / tube		8 / HRG 8	10 / HRG 10	14 / HRG 14
Inner tube diameter	\varnothing_i [mm]	9,7	11,7	16,0
Outer tube diameter	\varnothing_e [mm]	15,0	17,0	22,0
Tube length	Lt [mm]	23,0	28,0	40,3

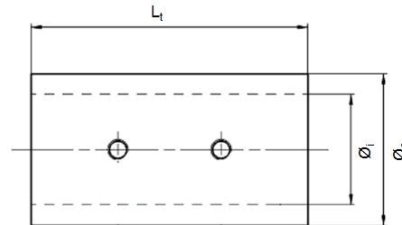

Instruction for use – re-use of screw

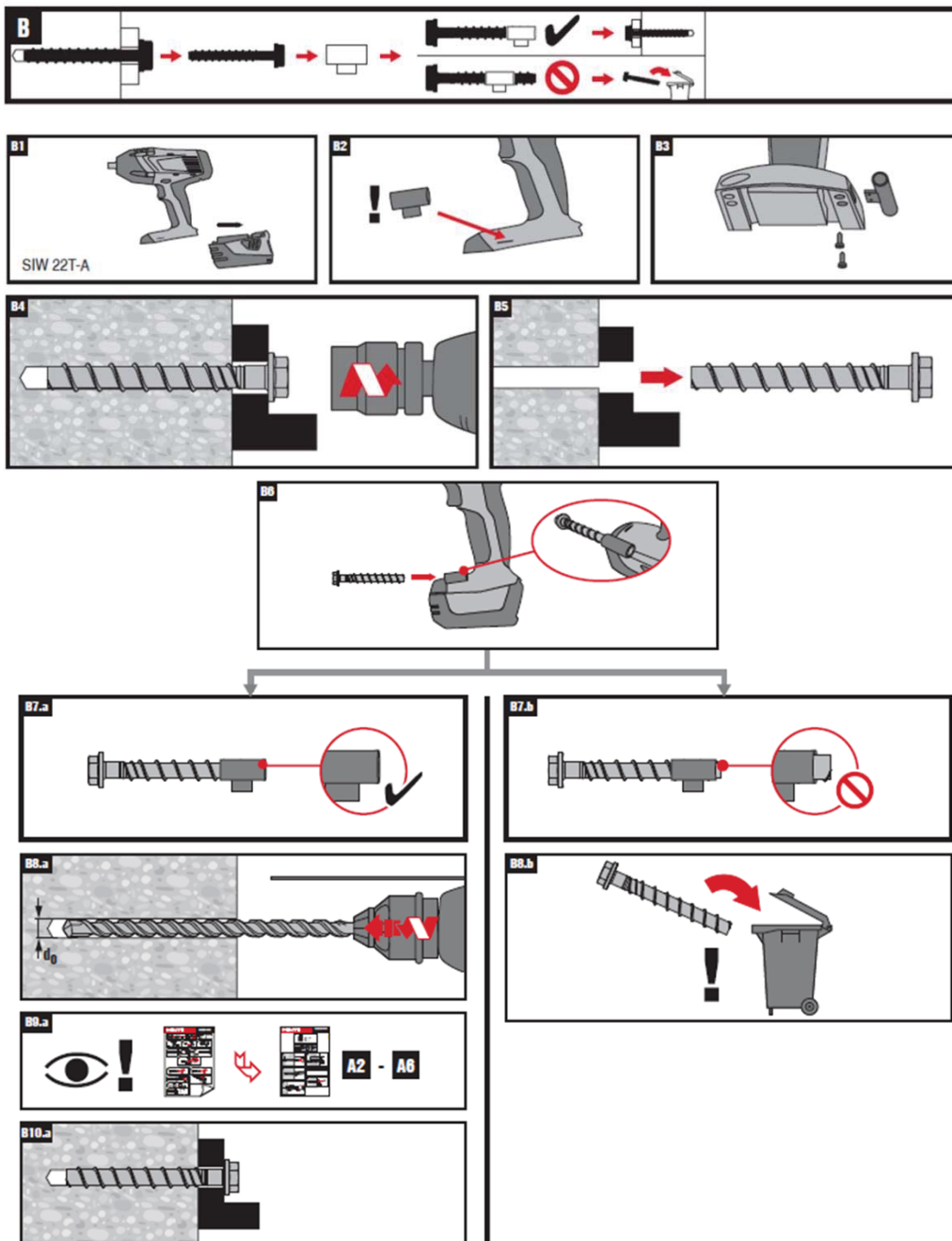

Basic loading data for single anchor in solid masonry units:

All data in this section applies to the following conditions:

Solid bricks: a reduction of the cross section area by a vertical perforation perpendicular to the bed joint area must not be greater than 15%

Drilling:

- Holes in Mz and KS drilled with TE rotary hammers drilled with hammering mode
- Holes in PPW drilled with TE rotary hammers drilled without hammering mode

Installation:

- The anchor is correct mounted, if there is neither a turn-through or spinning of the screw in the drill hole nor that an easy turning of the screw is possible after the installation procedure when the head of the screw has touched the fixture
- The recommended setting tool is Hilti SFH 22A

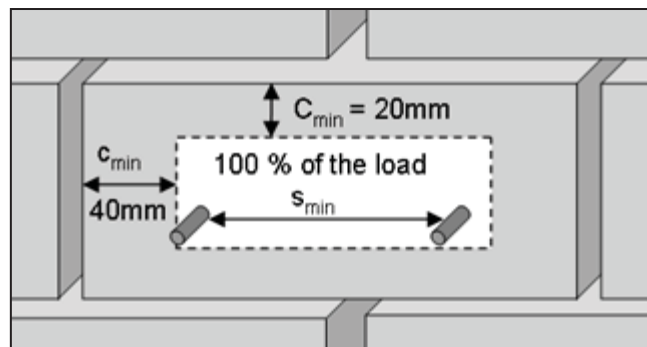

Edge distance and spacing influences:

- Distance to free edge free edge to solid masonry (Mz and KS) units $c_{min,free} \geq 200$ mm
- Distance to free edge free edge to solid masonry (autoclaved aerated gas concrete) units $c_{min,free} \geq 170$ mm
- The minimum distance to horizontal and vertical mortar joint $c_{min,h}$ and $c_{min,v}$ is stated in drawing below
- Minimum anchor spacing in one brick/block is $s_{min} = 80$ mm



The minimum edge distance to vertical mortar join for aerated gas concrete is 100mm,

Recommended loads

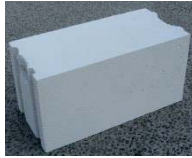
		Hilti		
Base material	Anchor size		8	10
	Type	HUS3	H, C	H, C, HF
	h_{nom}	[mm]	60	75
	Compressive strength class	[N/mm ²]	$F_{rec}^{a)}$ [kN] Tensile and Shear	
 Solid clay brick Mz 2,0-2DF DIN V 105-100 / EN 771-1 l [mm]: 240x115x113 h_{min} [mm]: 115	≥ 12		1,1	1,4
	≥ 20		1,6	2,0
 Solid sand-lime brick KS 2,0-2DF DIN V 106-100 / EN 771-2 LxWxH [mm]: 240x115x113 h_{min} [mm]: 115	≥ 12		1,3	1,4
	≥ 20		1,7	2,1
 Aerated concrete PPW 6-0,4 DIN 4165 / EN 771-4 LxWxH [mm]: 499x240x249 h_{min} [mm]: 240	≥ 6		0,7	0,9

- a) Characteristic resistance for tension, shear or combined tension and shear loading.
 The characteristic resistance is valid for single anchor or for a group of two or four anchors with spacing equal or larger than the minimum spacing s_{min} according to specification.

Load values:

- The technical data for the HUS3 anchors are reference loads for MZ 12 2,0-2DF, KS 12 2,0-2DF and PPW 6-0,4.
- The load Values are valid for non-structural applications.
- Due to the natural variation of stone solid bricks, on site anchor testing is recommended to validate technical data.
- The HUS3 anchor was installed and tested in the center area of solid bricks as shown considering minimal edge and space distances.
- The HUS3 anchor was not tested in the mortar joint between solid bricks or in hollow bricks; however a load reduction is expected.
- For brick walls where anchor position in brick cannot be determined, 100% anchor testing is recommended.

Limitations of loads:

- All data is for redundant fastening for not structural applications
- Plaster, graveling, lining or leveling courses are regarded as non-bearing and may not be taken into account for the calculation of embedment depth,
- The decisive resistance to tension loads is the lower value of N_{rec} (brick breakout, pull out) and $N_{max,pb}$ (pull out of one brick),

Pull out of one brick:

The allowable load of an anchor or a group of anchors in case of single brick pull out, $N_{max,pb}$ [kN], is given in the following tables:

Clay bricks:

$N_{max,pb}$ [kN]		brick breadth b_{brick} [mm]					
		80	120	200	240	300	360
brick length l_{brick} [mm]	240	1,1	1,6	2,7	3,3	4,1	4,9
	300	1,4	2,1	3,4	4,1	5,1	6,2
	500	2,3	3,4	5,7	6,9	8,6	10,3

All other brick types:

$N_{max,pb}$ [kN]		brick breadth b_{brick} [mm]					
		80	120	200	240	300	360
brick length l_{brick} [mm]	240	0,8	1,2	2,1	2,5	3,1	3,7
	300	1,0	1,5	2,6	3,1	3,9	4,6
	500	1,7	2,6	4,3	5,1	6,4	7,7

$N_{max,pb}$ = resistance for pull out of one brick

l_{brick} = length of the brick

b_{brick} = breadth of the brick

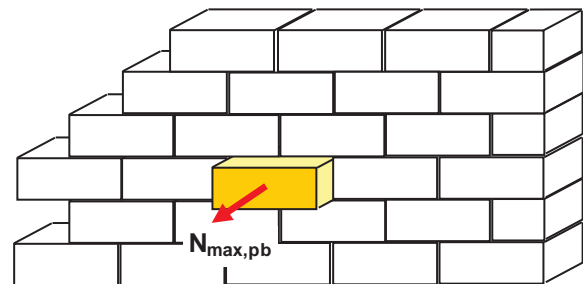
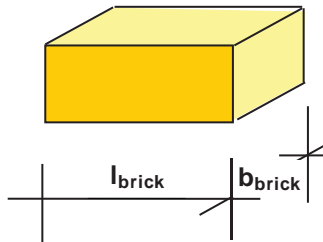

Basic loading data for single anchor in Hollow core slab:

Basic loading data

All data in this section applies to

- Correct setting (See setting instruction)
- No edge distance and spacing influence
- Ratio core width / web thickness $w/e \leq 4,2$
- Concrete C 30/37 to C 50/60

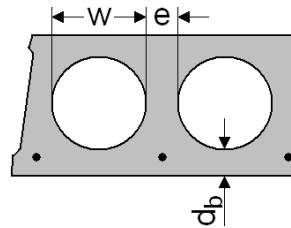

Characteristic resistance

Anchor size			8	10
Type	HUS3		C, H	C, H, HF
Bottom flange thickness	$d_b \geq$	[mm]	30	30
All load directions	F_{Rk}	[kN]	2,0	2,0

Design resistance

Anchor size			8	10
Type	HUS3		C, H	C, H, HF
Bottom flange thickness	$d_b \geq$	[mm]	30	30
All load directions	F_{Rd}	[kN]	1,3	1,3

Recommended loads

Anchor size			8	10
Type	HUS3		C, H	C, H, HF
Bottom flange thickness	$d_b \geq$	[mm]	30	30
All load directions ^{a)}	F_{rec}	[kN]	0,95	0,95

a) With overall partial safety factor for action $\gamma = 1,4$. The partial safety factors for action depend on the type of loading and shall be taken from national regulations.

Requirements for redundant fastening

The definition of redundant fastening according to Member States is given in the ETAG 001 Part six, Annex 1, In Absence of a definition by a Member State the following default values may be taken

Minimum number of fixing points	Minimum number of anchors per fixing point	Maximum design load of action N_{Sd} per fixing point ^{a)}
3	1	2 kN
4	1	3 kN

a) The value for maximum design load of actions per fastening point N_{Sd} is valid in general that means all fastening points are considered in the design of the redundant structural system. The value N_{Sd} may be increased if the failure of one (= most unfavourable) fixing point is taken into account in the design (serviceability and ultimate limit state) of the structural system e.g. suspended ceiling.

Setting

Anchor size		8	10
Type	HUS3	C, H	C, H, HF
Rotary hammer		Hilti TE 6 / TE 7	
drill bit		TE-CX 4	
Impact screw driver		SIW 22 A, 1 st or 2 nd gear	

Setting instruction

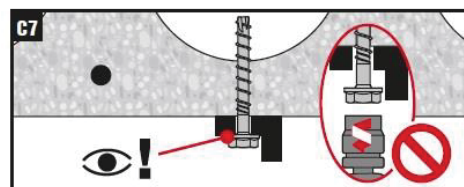
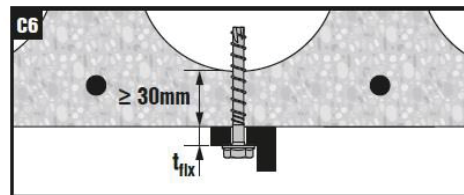
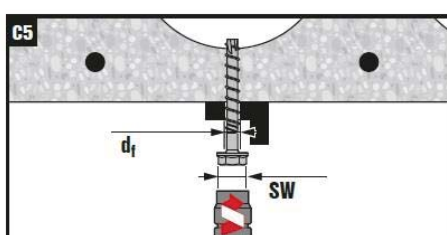
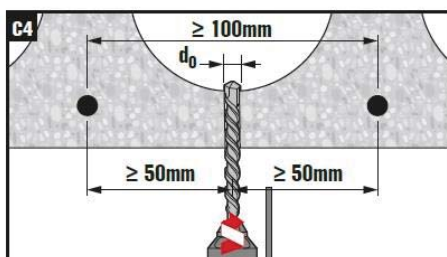
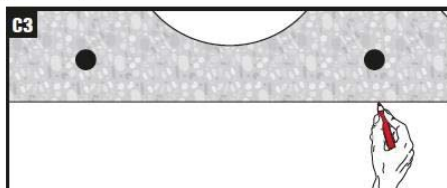
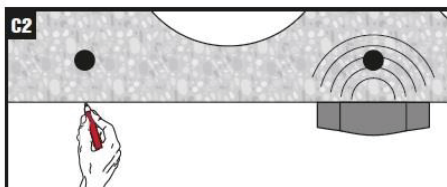
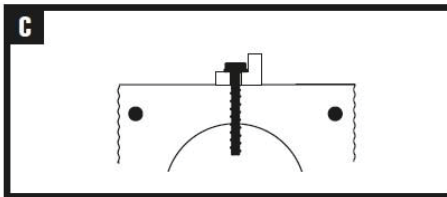

Setting details

Anchor size			8	10
Type	HUS3		C, H	C, H, HF
Nominal embedment depth	$h_{nom} \geq$	[mm]	40	45
Bottom flange thickness	$d_b \geq$	[mm]	30	30
Nominal diameter of drill bit	d_o	[mm]	8	10
Cutting diameter of drill bit	$d_{cut} \leq$	[mm]	8,45	10,45
Nominal depth of drill hole ^{a)}	$h_1 \geq$	[mm]	40	40
Diameter of clearance hole in the fixture	$d_f \leq$	[mm]	12	14
Nominal effective anchorage depth	h_{ef}	[mm]	30	30
Distance between anchor position and prestressing steel	$a_p \geq$	[mm]	50	50

a) Nominal depth of drill hole may be deeper than bottom flange thickness

Type	Size [mm]	Length [mm]	$d_b=30$ [mm]		$d_b=35$ [mm]		$d_b=40$ [mm]		$d_b=50$ [mm]	
			$t_{fix,min}$ [mm]	$t_{fix,max}$ [mm]	$t_{fix,min}$ [mm]	$t_{fix,max}$ [mm]	$t_{fix,min}$ [mm]	$t_{fix,max}$ [mm]	$t_{fix,min}$ [mm]	$t_{fix,max}$ [mm]
HUS3-H	8	55	5	15	5	10	5	5	5	5
		65	5	25	5	20	5	15	5	5
		75	5	35	5	30	5	25	5	15
		85	15	45	15	40	15	35	15	25
		100	30	60	30	55	30	50	30	40
		120	50	80	50	75	50	70	50	60
		150	80	110	80	105	80	100	80	90
HUS3-C	8	65	15	25	15	20	15	15	15	5
		75	15	35	15	30	15	25	15	15
		85	15	45	15	40	15	35	15	25
HUS3-H	10	60	5	15	5	10	5	5	5	5
		70	15	25	15	20	15	15	15	5
		80	5	35	5	30	5	25	5	15
		90	5	45	5	40	5	35	5	25
		100	15	55	15	50	15	45	15	35
		110	25	65	25	60	25	55	25	45
		130	45	85	45	80	45	75	45	65
HUS3-HF	10	150	65	105	65	100	65	95	65	85
		60	5	15	5	10	5	5	5	5
		80	5	35	5	30	5	25	5	15
		100	15	55	15	50	15	45	15	35
HUS3-C	10	110	25	65	25	60	25	55	25	45
		70	15	25	15	20	15	15	15	10
		90	15	45	15	40	15	35	15	25
		100	15	55	15	50	15	45	15	35

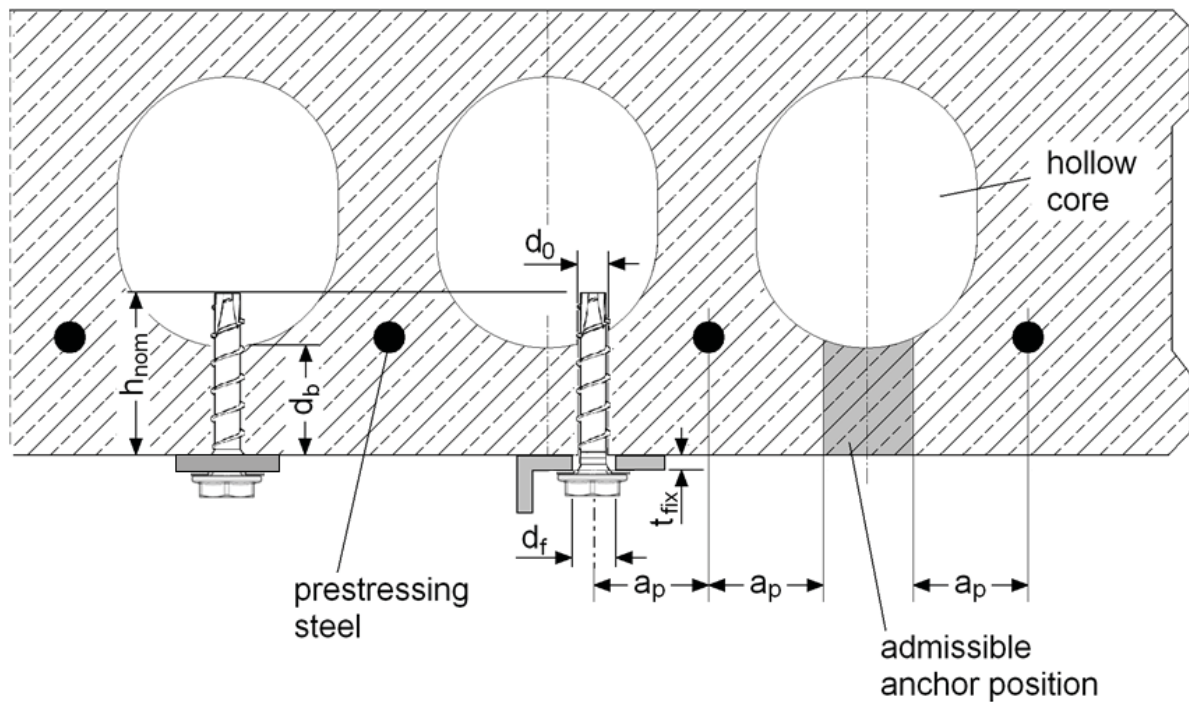

Anchor spacing and edge distance

Anchor size			8	10
Type	HUS3		C, H	C, H, HF
Minimum edge distance	$c_{min} \geq$	[mm]	100	
Minimum anchor spacing	$s_{min} \geq$	[mm]	100	
Minimum distance between anchor groups	$a_{min} \geq$	[mm]	100	

