

CONTENT

1	Introduction	4
1.1	Definition	4
1.2	The S-BT system	4
1.2.1	S-BT fastener and designation	4
1.2.2	Drilling tool	5
1.2.3	Stepped drill bit	5
1.2.4	Installation tool	5
1.2.5	S-DG depth gauge with a S-CC calibration card	6
1.3	Fastening mechanism	6
1.4	S-BT system features and benefits – simplified fastening to steel	7
2	Applications	8
2.1	Grating fastening system	8
2.2	S-BT with MM and MQ installation channel system	10
2.3	Fastening instrumentation, junction boxes and lighting	11
2.4	Fastening cable / conduit connectors	12
2.5	Fastening cable tray supports	12
3	Technical data	13
3.1	Product data	13
3.1.1	S-BT material specifications and dimensions	13
3.1.2	Drilling tool, setting tool, accessories and inserts	14
3.2	Load data	14
3.2.1	Recommended loads	14
3.2.2	Design resistance	14
3.2.3	Recommended interaction formula for combined loading – steel and aluminum base materials	15
3.2.4	Base material thickness t_{II} and type of bore hole	15
3.2.5	Thickness of fastened material t_I	16
3.2.6	Spacing and edge distances	16
3.2.7	Application limit and thickness of base material	16
3.2.8	Fastening quality assurance and fastening inspection	17
3.2.9	Fastener selection and system recommendation	17
3.2.10	Installation details	17
4	Method statement	19
4.1	Instructions for use – S-BT-MF M8/M10/W10 AN 6	19
4.2	Instructions for use – S-BT-MF M8/7 AN 6 and S-BT-MR M8/7 SN 6	20
4.3	Instructions for use – S-BT-GF M8/7 AN 6 and S-BT-GR M8/7 SN 6	21
5	Performance	22

5.1	Nomenclature and symbols	22
5.2	Design concepts	23
5.3	Static capacity of the S-BT threaded stud	24
5.3.1	Tensile load deformation behavior of S-BT threaded stud fastenings.....	24
5.3.2	Pull out strength of S-BT threaded stud fastenings	25
5.3.3	Shear strength of S-BT threaded stud fastenings	26
5.4	Vibration effects on S-BT threaded stud fastenings	27
5.5	Resistance of S-BT fastenings under dynamic tensile loading	28
5.6	Influence of the S-BT on the fatigue strength of structural steel	30
5.7	Influence of glue coatings on the loosening torque	31
5.8	Corrosion resistance.....	32
5.8.1	Selection of a suitable fastener.....	32
5.8.2	Galvanic (contact) corrosion	34
5.8.3	Carbon steel S-BT studs.....	35
5.8.4	Stainless steel S-BT studs.....	36
5.9	Volume swelling of SN 12 sealing washer (stainless steel S-BT studs).....	38
5.10	Material safety data sheet acc. to ISO/DIS 11014 for EPDM sealing ring of AN10 and SN12 sealing washer 39	
5.10.1	Identification of substance	39
5.10.2	Composition/data on components	39
5.10.3	Hazards identification	39
5.10.4	First aid measures	39
5.10.5	Fire fighting measures	40
5.10.6	Accidental release measures.....	40
5.10.7	Handling and storage.....	40
5.10.8	Exposure controls and personal protection	40
5.10.9	Physical and chemical properties	41
5.10.10	Stability and reactivity	41
5.10.11	Toxicological information	41
5.10.12	Ecological information.....	42
5.10.13	Disposal considerations	42
5.10.14	Transport information.....	42
5.10.15	Regulations	42
5.10.16	Other information	43
6	Fastener program	44
7	Approvals	45
7.1	Bureau Veritas	45

1 Introduction

1.1 Definition

The S-BT fasteners are threaded studs manufactured from hardened carbon steel 1038 and austenitic-ferritic (Duplex) stainless steel 1.4462 acc. DIN-EN 10088-1 (AISI 316 SS equivalent). The S-BT threaded studs are fasteners with male threads (metric M8 and M10 or inch W10) for attachment on one end and a threaded tip on the other end for embedment into the structural steel or aluminum. Carbon steel studs are supplied with an aluminum sealing washer Ø 10 mm, stainless steel studs are supplied with a stainless steel sealing washer Ø 12 mm, both with an EPDM sealing ring.

The S-BT technology can be used as an alternative to the welds and bolts used to attach materials to structural steel and for fastening applications in shipbuilding environment and offshore structures.

The S-BT fastener will be screwed in into a pre-drilled hole. The screw is tapping its own internal mating threads when installed into base material. A special stepped drill bit is needed to guarantee an accurately defined pre-drilled hole in terms of borehole depth and diameter. With this system reliable fastenings can be made in steel with a thickness $3\text{mm} [0.12"] \leq t < 6\text{mm} [0.24"]$ and in aluminum with a thickness $5\text{mm} [0.20"] \leq t < 6\text{mm} [0.24"]$ in pre-drilled through holes. For base materials steel and aluminum $t \geq 6\text{mm} [0.24"]$ the fastener is intended to be set in a pre-drilled pilot hole. The benefit of pilot holes is no through penetration of the base material therefore no rework of the protective surface coating on the back side is needed.

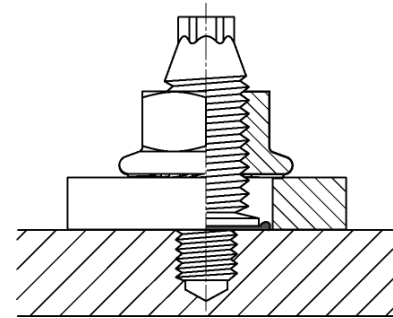

Section of S-BT fastener installed in a pilot hole

1.2 The S-BT system

1.2.1 S-BT fastener and designation

	Stainless steel	Carbon steel
Multipurpose fastening	S-BT-MR M8/7 SN 6	S-BT-MF M8/7 AN 6
	S-BT-MR M8/7 SN 6 AL	S-BT-MF M8/15 AN 6
	S-BT-MR M8/15 SN 6	S-BT-MF M10/15 AN 6
	S-BT-MR M8/15 SN 6 AL	S-BT-MF W10/15 AN 6
	S-BT-MR M10/15 SN 6	
	S-BT-MR M10/15 SN 6 AL	
	S-BT-MR W10/15 SN 6	
	S-BT-MR W10/15 SN 6 AL	
Grating fastening	S-BT-GR M8/7 SN 6	S-BT-GF M8/7 AN 6
	S-BT-GR M8/7 SN 6 AL	

S	Indication of Product of Hilti Business Area S crew F astening
BT	B lunt T ip
M, G	Indication of application. M ultipurpose fastening, G rating fastening
R, F	Indication of material. R (Rostfrei = Stainless), F (Feuerverzinkt = Hot Dip Galvanized)
M8, M10, W10	Thread type and size
15, 7	Fastening material thickness [mm]
SN, AN	Washer type, SN S tainless steel N eoprene, AN A luminum N eoprene
6	Minimum base material thickness for installation in a pilot hole
AL	Indication of type of base material (AL = A luminum)

1.2.2 Drilling tool

Designation	Item Description	Application
SF BT 22-A (B22/2.6 or 5.2Ah)	Drilling tool for Europe, Asia	Drilling
SF BT 18-A (B18/2.6 or 5.2Ah)	Drilling tool for HNA	Drilling

Regarding the drilling time and the bore hole quality, a special tool with optimized revolutions per minute (~4000 rpm) is needed. The cordless drilling machines SF BT 22-A and SF BT 18-A are optimized for the drilling process in this application.



SF BT 22-A drilling tool

1.2.3 Stepped drill bit

Designation	Item Description	Application
TS-BT 5.5-74 S	Stepped drill bit for ≥ 3 mm [0.12"] base material thickness	Drilling in steel
TS-BT 5.5-74 AL	Stepped drill bit for ≥ 5 mm [0.20"] base material thickness	Drilling in aluminum



TS-BT 5.5-74 S stepped drill bit

A stepped drill prevents the perforation of the base material ($t \geq 6$ mm [0.24"] and ensures a proper drilling depth and an accurate bore hole in terms of diameter. The front part generates the pilot hole in the base material in which the self-tapping thread will be set. The step (increased diameter) prevents the drill bit from further movement and through-penetration. Furthermore, the step will create a "shiny-ring" around the hole which allows the installer to recognize the end of the drilling process.

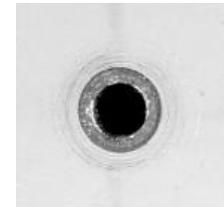

Shiny ring around the bore hole

Each S-BT sales box includes the corresponding TS-BT stepped drill bit. The stepped drill bit typically resists at least 100 bore holes with a constant geometry.

Hilti recommends disposing of the used TS-BT stepped drill bit once the complete sales packaging S-BT studs are consumed. Hilti then advises using the new stepped drill bit out of the new sales packaging.



1.2.4 Installation tool

Designation	Item Description	Application
SFC 22-A (B22/2.6 or 5.2Ah)	UCD tool for Europe, Asia	Setting
SFC 18-A (B18/2.6 or 5.2Ah)	UCD tool for HNA	Setting

For the installation process, a recommended torque up to 13 Nm is needed. The cordless drill drivers SFC 22-A and S-FC 18-A fulfill the requirements for the installation process.



Hilti UCD SFC 22-A (cordless)

1.2.5 S-DG depth gauge with a S-CC calibration card

Designation	Item Description	Application
S-DG BT M8/7 Short 6	Depth gauge for S-BT M8/7 _N 6	Setting
S-DG BT M8/15 Long 6	Depth gauge for S-BT M8/15 _N 6	Setting
S-DG BT M10-W10/15 Long 6	Depth gauge for S-BT M10/W10 _N 6	Setting
S-CC BT 6	Calibration card for calibration of the depth gauge (short/long studs)	Calibration
S-CG BT /7 Short 6	Check gauge for verification of the stand-off for short studs (7 mm)	Verification
S-CG BT /15 Long 6	Check gauge for verification of the stand-off for long studs (15 mm)	Verification



S-DG BT mechanical depth gauge

In order to verify the exact screw-in depth and a proper compressed sealing washer, the S-BT studs have to be installed with the appropriate depth gauge. With this tool the screw-in depth can be adjusted in a range of 0 - 1.5 mm (3 steps, 0.5mm per step).

The S-CC BT calibration card is needed to check the stand-off of the S-BT stud (ensure the proper screw-in depth) and to adjust/calibrate the S-DG depth gauge. After finding the right adjustment level for the S-DG depth gauge, the gauge can be adjusted and the studs can be installed without additional check. The depth gauge has to be re-adjusted (calibrated) at following times:

- Start of the installation process
- Change of the working position (upwards, downwards, horizontal)
- Installer change

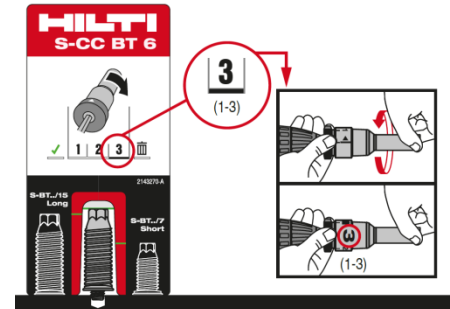

Design and functionality of the mechanical calibration card S-CC BT

Section 4 comprises the instructions for use (IFU) of the S-BT studs with a detailed illustration how to use the S-DG depth gauge and the S-CC calibration card.

The lifetime of the S-DG BT depth gauge is ≥ 1000 settings.



1.3 Fastening mechanism

The S-BT fastener will be screwed in into a pre-drilled hole. The threaded stud is tapping its own internal mating threads when installed into base material. The S-BT fasteners are anchored in the base material by way of a keying effect, i.e. self-tapping screws form a thread in the base material. The ground cross-sections of an S-BT fastener in steel shows the thread of the fastener engaged with the base material.



Fastening mechanism of the S-BT stud in steel

1.4 S-BT system features and benefits – simplified fastening to steel

No rework:

Stud welding or through-bolting, for example, may require reworking of the protective surface coating. With the S-BT system, the stud is set into a small pre-drilled hole and the drill entry point is then completely sealed by the stud washer during setting.



Rework

Simple and fast:

A minimal amount of training is all that is required for a user to be able to install up to 100 studs per hour.

High corrosion resistance:

The stainless steel S-BT fasteners are made from the duplex stainless steel type 1.4462, which is equivalent to AISI 316 (A4) steel grade and suitable for aggressive environments like in coastal and offshore applications. The coating of the carbon steel S-BT fasteners consists of an electroplated Zn-alloy for cathodic protection and a top coat for chemical resistance (Duplex-coating). The use of this coating is limited to indoor environments and outdoor (no coastal) environments with low pollution. Refer to section 5.8 for selection of the suitable fastener in terms of corrosion.



Corrosion

High tension and shear load values:

S-BT delivers performance comparable to methods such as stud welding. See load data tables in section 3.2 for details.

Fasten to all steel shapes:

Unlike clamps, which are limited by the configuration of the base steel, the S-BT is ideal for use on hollow sections, channel sections, wide flanges and angles.



Loosening

Fasten to thin steel and aluminum:

In addition to fastening to standard construction steel $t \geq 6\text{mm}$ [0.24"] (pilot hole), the S-BT can also be used to fasten to aluminum $t \geq 6\text{mm}$ [0.24"] (pilot hole) and 5mm [0.20"] $\leq t < 6\text{mm}$ [0.24"] (drill through hole). Furthermore fastening in thin steel 3mm [0.12"] $\leq t < 6\text{mm}$ [0.24"] (drill through hole) is possible.

Cordless and Portable:

The cordless drilling and installation tools eliminate the need for electrical cords and heavy welding equipment.

No through-penetration for base material $\geq 6\text{mm}$ [0.24"]:

The special process of drilling and installation results in secure fastening of the fastener without through-penetration of the base material. Therefore no rework of the protective surface coating on the back side is needed.

2 Applications

2.1 Grating fastening system

X-FCM-M grating disc for use with S-BT-GF M8/7 or S-BT-GR M8/7

X-FCM-R grating disc for use with S-BT-GR M8/7

A fastening system designed for attaching metal or fiber-glass grating to coated steel.

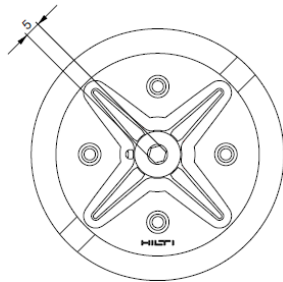
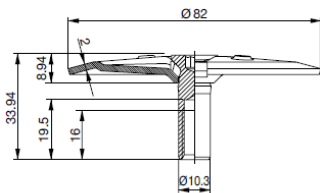
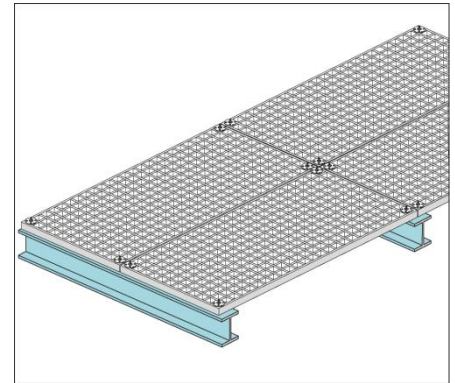
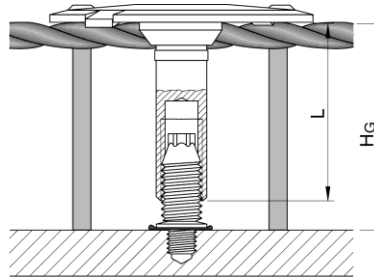

X-FCM-M grating disc

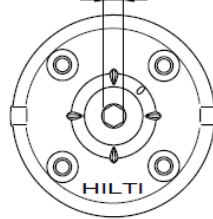
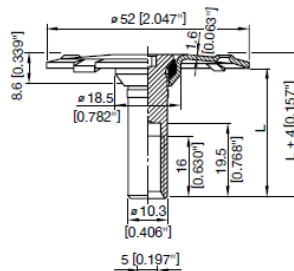

X-FCM-R grating disc



Important: The X-FCM-R and X-FCM-M system are not designed or intended to resist shear loads.

X-SEA-R 30 M8 extension adaptor

For use with X-FCM-R grating fasteners for fastening of grating with a height in excess of 50 mm [1.97"].

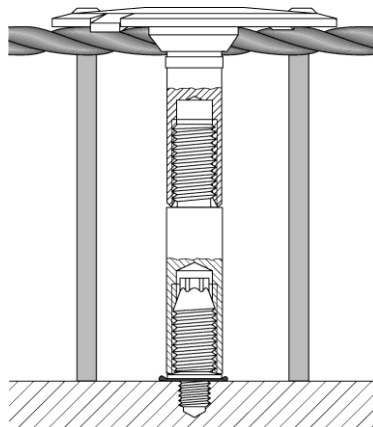

X-SEA-R 30 M8 extension adaptor

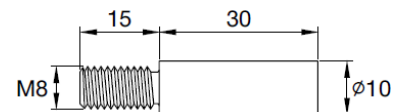

Fastener Selection

Designation	L [mm/in.]	Grating height HG, range [mm/in.]	Grating height with X-SEA-R 30 M8
X-FCM-R 25/30	23/0.91	25-30/0.98-1.18	55-60/2.16-2.36
X-FCM-R 1"-1¼"	27/1.06	29-34/1.14-1.34	59-64/2.32-2.52
X-FCM-R 35/40	33/1.30	35-40/1.38-1.57	65-70/2.56-2.75
X-FCM-R 45/50	43/1.69	45-50/1.77-1.97	75-80/2.91-3.15
X-FCM-M 25/30	23/0.91	25-30/0.98-1.18	
X-FCM-M 1"-1¼"	27/1.06	29-34/1.14-1.34	
X-FCM-M 35/40	33/1.30	35-40/1.38-1.57	
X-FCM-M 45/50	43/1.69	45-50/1.77-1.97	

Installation instructions

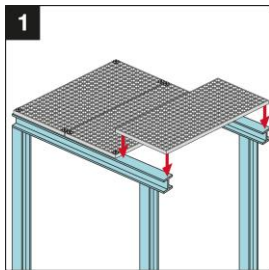

1 Lay grating section in final position.

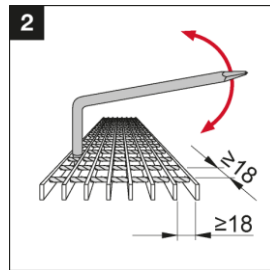

2 Expand grating openings if necessary.

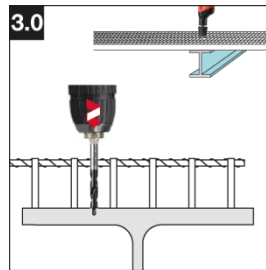

3.0 Pre-drill with **TS-BT** stepped drill bit.

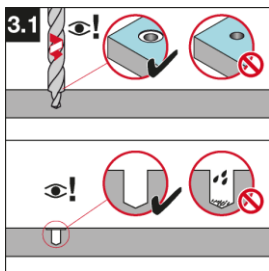
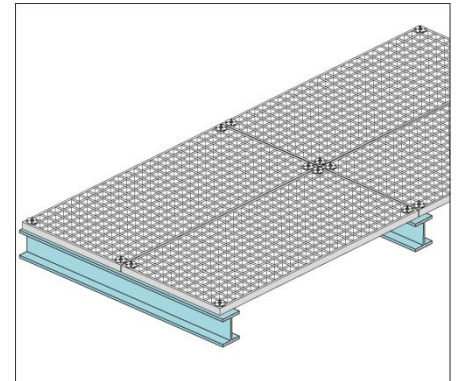

3.1 Pre-drill until shoulder grinds a shiny ring. The drilled hole and the area around drilled hole must be clean and free from liquids and debris.

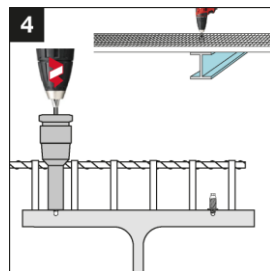

4 Screw-in **S-BT** studs into drilled hole.

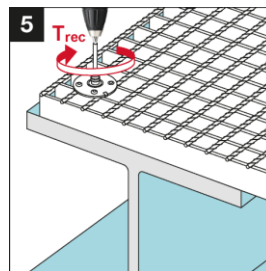

5 Tighten **X-FCM** discs with 5mm Allen-type bit with the suited installation torque.

Important notes:

These are abbreviated instructions which may vary by application. ALWAYS review / follow the instructions for use (IFU) accompanying the product. In case of a **drill through hole**, rework of the coating on the back side of the plate / profile may be needed.

2.2 S-BT with MM and MQ installation channel system

MM channel system for use with S-BT-MF

MQ channel system for use with S-BT-MF or S-BT-MR

Installation instructions

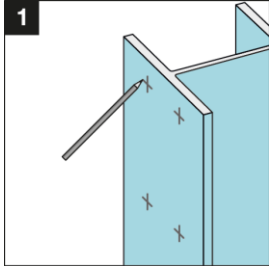

1
Mark location of each fastening.

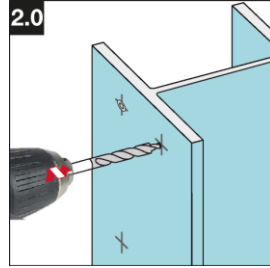

2.0
Pre-drill with **TS-BT** stepped drill bit.

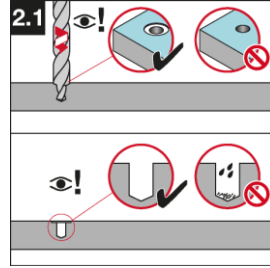

2.1
Pre-drill until shoulder grinds a shiny ring. The drilled hole and the area around drilled hole must be clean and free from liquids and debris.

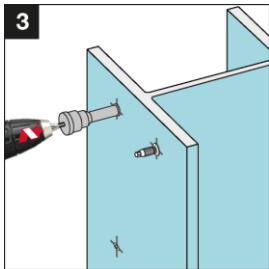

3
Screw-in S-BT studs into drilled hole.

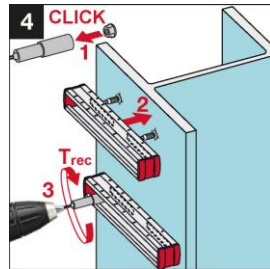

4 **CLICK**
Position channel on S-BT studs and hold in place. Tighten the nuts with the suited installation torque.

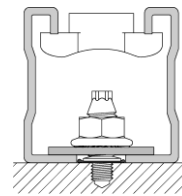
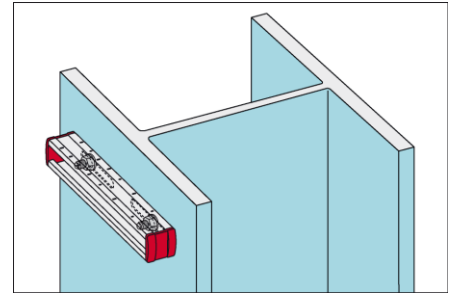

Note: In case of applied shear load, the S-BT should be placed according to illustration (end of slotted hole)

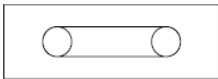

Two **S-BT** studs in one slotted hole



One **S-BT** stud in each slotted hole

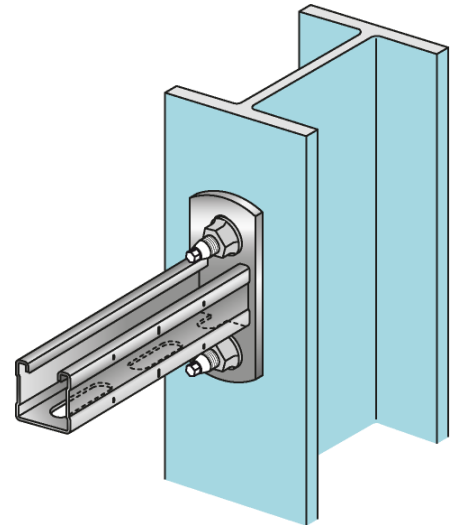

2.3 Fastening instrumentation, junction boxes and lighting

S-BT screw-in threaded studs for attaching instrumentation, junction boxes and lighting to coated steel and high-strength steel

Installation instructions

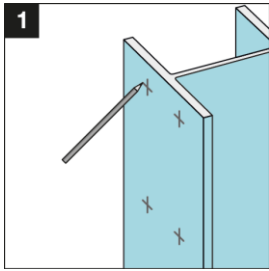

1
Mark location of each fastening.

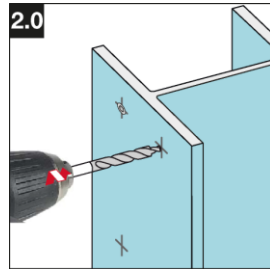

2.0
Pre-drill with **TS-BT** stepped drill bit.

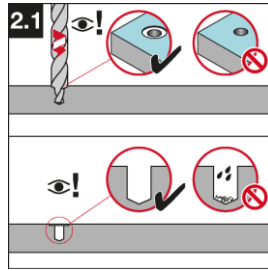

2.1
Pre-drill until shoulder grinds a shiny ring. The drilled hole and the area around drilled hole must be clean and free from liquids and debris.

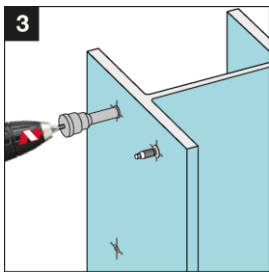

3
Screw-in S-BT studs into drilled hole.

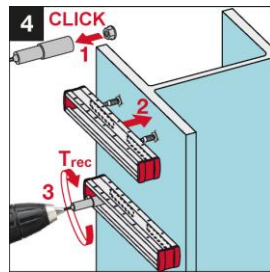

4 **CLICK**
Position channel on S-BT studs and hold in place. Tighten the nuts with the suited installation torque.

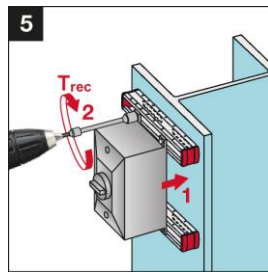

5
Fasten the accessory on the channel with the suited installation torque.

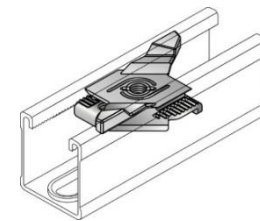
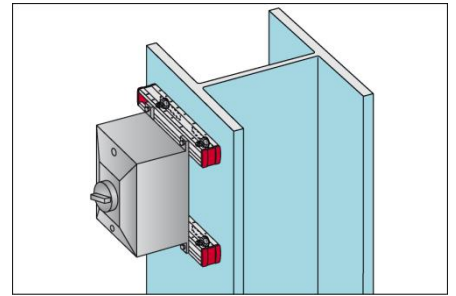

MM Channel System with wing nut
M6, M8, M10

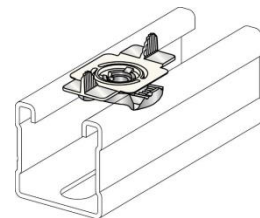

MQ Channel System with wing nut
M6, M8, M10, M12, 1/4", 3/8"

For fastening the accessory on the Hilti channel or bracket always use the suitable Hilti wing nut in combination with a proper bolt. The instruction for use (IFU) accompanying the sales packaging of the Hilti wing nuts comprises detailed information about the installation of the wing nut and the tightening torque T_{rec} .

Important notes:

These are abbreviated instructions which may vary by application. ALWAYS review / follow the instructions for use (IFU) accompanying the product. In case of a **drill through hole**, rework of the coating on the back side of the plate / profile may be needed.

2.4 Fastening cable / conduit connectors

Stainless steel and carbon steel S-BT screw-in threaded studs for fastening cable and conduit connectors (T-bars) to coated steel.

Installation instructions

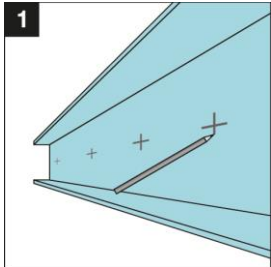

1
Mark location of each fastening.

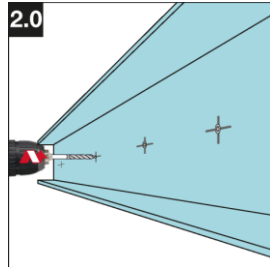

2.0
Pre-drill with **TS-BT** stepped drill bit.

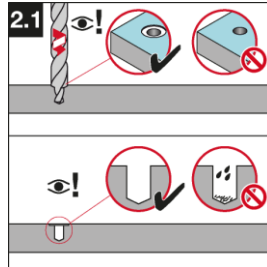

2.1
Pre-drill until shoulder grinds a shiny ring. The drilled hole and the area around drilled hole must be clean and free from liquids and debris.

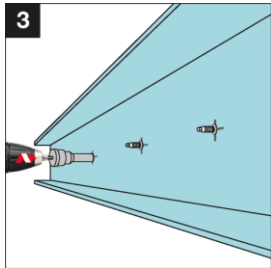

3
Screw-in S-BT studs into drilled hole.

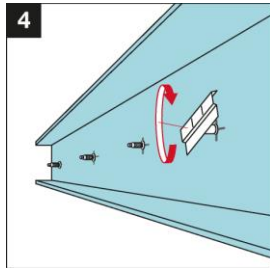

4
Screw on the connector and hand tighten.

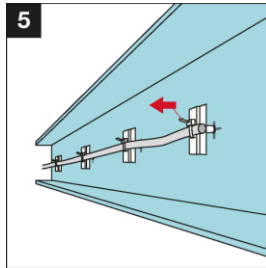

5
Align connectors. Fasten the cable / conduit on the connector.

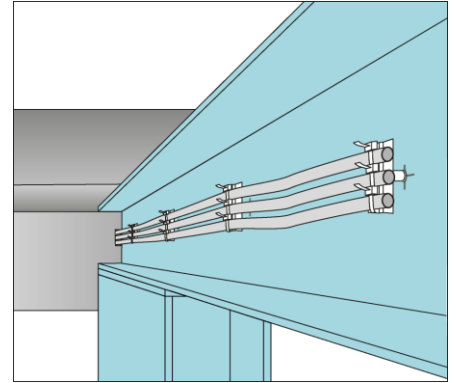

2.5 Fastening cable tray supports

Stainless steel and carbon steel threaded studs for fastening cable trays to coated steel.

Installation instructions

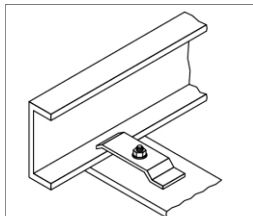

Hold down clamp

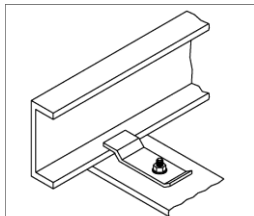

Expansion guide clip

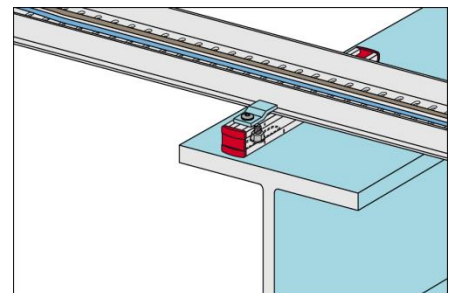
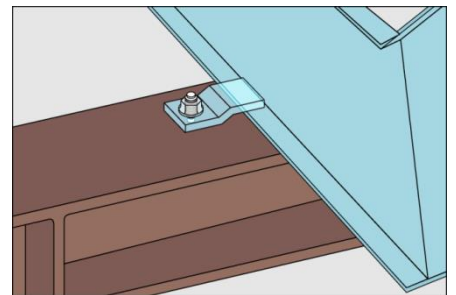
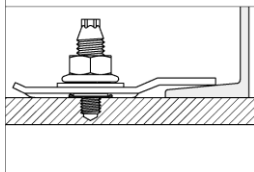
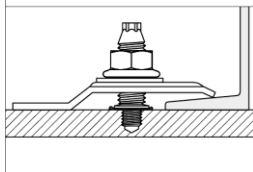

Important notes:

These are abbreviated instructions which may vary by application. ALWAYS review / follow the instructions for use (IFU) accompanying the product. In case of a **drill through hole**, rework of the coating on the back side of the plate / profile may be needed.

3 Technical data

3.1 Product data

3.1.1 S-BT material specifications and dimensions

	Stainless steel S-BT-MR S-BT-GR	Carbon steel S-BT-MF S-BT-GF
Threaded shank	① Stainless steel (CrNiMo alloy) S31803 (1.4462)	② Carbon steel 1038 / duplex-coated
Washer	③ SN 12-R Ø 12mm [0.47"] Stainless steel (X2CrNiMo 17-12-2) S31635 (1.4404)	④ AN 10-F Ø 10mm [0.39"] Aluminum
Serrated flange nut	⑤ Stainless steel grade A4 - 70/80	⑥ Carbon steel HDG, grade 8
Sealing washer	③ or ④ Elastomer, black, resistant to UV, salt water, water, ozone, oils, etc.	

S-BT-MR M10/15 SN 6
 S-BT-MR M10/15 SN 6 AL^{*)}
 S-BT-MR W10/15 SN 6
 S-BT-MR W10/15 SN 6 AL^{*)}
 S-BT-MF M10/15 AN 6
 S-BT-MF W10/15 AN 6

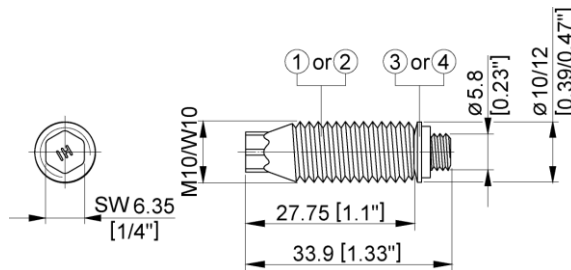

S-BT-MR M8/7 SN 6
 S-BT-MR M8/7 SN 6 AL^{*)}
 S-BT-GR M8/7 SN 6^{*)}
 S-BT-GR M8/7 SN 6 AL^{*)}
 S-BT-MF M8/7 AN 6
 S-BT-GF M8/7 AN 6^{*)}

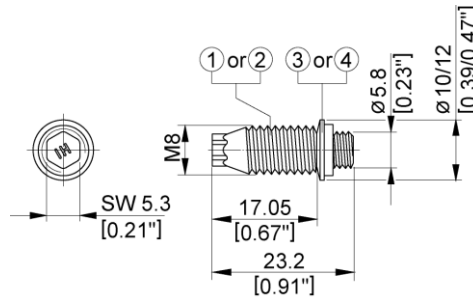

S-BT-MR M8/15 SN 6
 S-BT-MR M8/15 SN 6 AL^{*)}
 S-BT-MF M8/15 AN 6

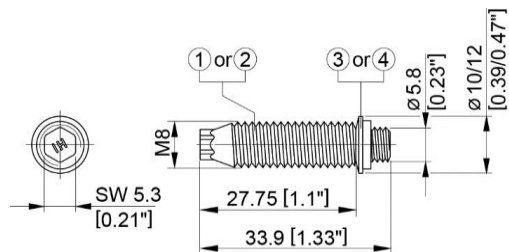

^{*)} S-BT-GR and S-BT-GF for grating fastening. Package does not include serrated flange nuts

^{*)} for use in aluminum base material

Serrated flange nut

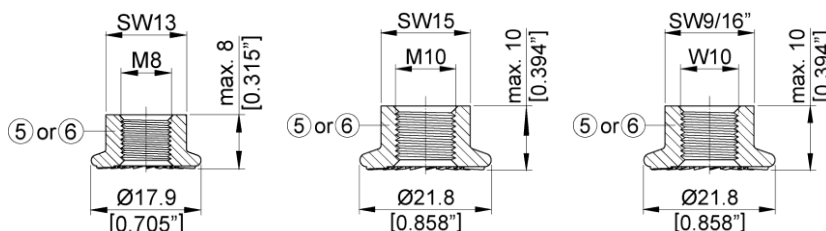

3.1.2 Drilling tool, setting tool, accessories and inserts

For more details refer to section 3.2.9 “Fastener selection and system recommendation”

3.2 Load data

3.2.1 Recommended loads

	S-BT-			6	
	Steel	Steel	Aluminum	Steel	Steel
Drill hole type and base material thickness	Pilot hole, $t_{II} \geq 6 \text{ mm [0.24"]}$ Drill through hole, $5 \text{ mm [0.20]} \leq t_{II} < 6 \text{ mm [0.24"]}$			Drill through hole $3 \text{ mm} \leq t_{II} < 5 \text{ mm}$	
Base material	S235 A36	S355 Grade 50	$R_m \geq 270$ N/mm ²	S235 A36	S355 Grade 50
Tension, N_{rec} [kN/lb]	1.8 / 405	2.3 / 520	1.0 / 225	1.0 / 225	1.3 / 290
Shear, V_{rec} [kN/lb]	2.6 / 585	3.2 / 720	1.5 / 340	1.5 / 340	1.9 / 430
Moment, M_{rec} [Nm/lbft]	7.0 / 5.2	7.0 / 5.2	4.8 / 3.5	7.0 / 5.2	7.0 / 5.2

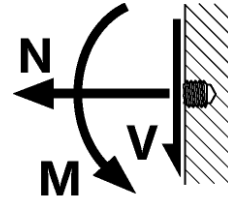

Conditions for recommended loads:

- Use S-BT-MR and S-BT-MF (multipurpose fastening) only with the attached Hilti serrated flange nuts M8, M10, W10 (⊙ or ⊗ refer to section 3.1.1)
- Global factor of safety Ω for static pull-out and static shear ≥ 3 (based on mean ultimate test value).
- Minimum edge distance = 6 mm [0.24"], spacing $\geq 15 \text{ mm [0.59"]}$
- Effect of base metal vibration and stress (e.g. areas with tensile stress) considered.
- Redundancy (multiple fastening) must be provided.
- If eccentric loading exists (e.g. use of an angle clip), moments caused by off-center loading must be considered.

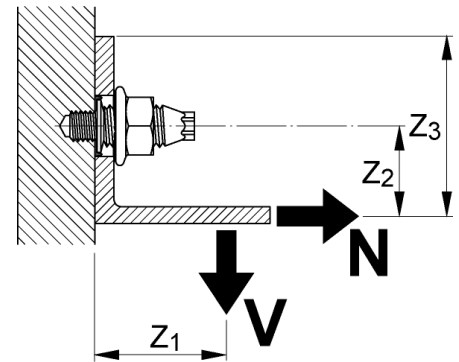

3.2.2 Design resistance

	S-BT-			6	
	Steel	Steel	Aluminum	Steel	Steel
Drill hole type and base material thickness	Pilot hole, $t_{II} \geq 6 \text{ mm [0.24"]}$ Drill through hole, $5 \text{ mm [0.20]} \leq t_{II} < 6 \text{ mm [0.24"]}$			Drill through hole $3 \text{ mm} \leq t_{II} < 5 \text{ mm}$	
Base material	S235 A36	S355 Grade 50	$R_m \geq 270$ N/mm ²	S235 A36	S355 Grade 50
Tension, N_{Rd} [kN/lb]	2.5 / 560	3.2 / 720	1.4 / 315	1.4 / 315	1.8 / 405
Shear, V_{Rd} [kN/lb]	3.6 / 810	4.5 / 1010	2.1 / 470	2.1 / 470	2.7 / 610
Moment, M_{Rd} [Nm/lbft]	9.8 / 7.2	9.8 / 7.2	6.7 / 4.9	9.8 / 7.2	9.8 / 7.2

Conditions for design resistance:

- Use S-BT-MR and S-BT-MF (multipurpose fastening) only with the attached Hilti serrated flange nuts M8, M10, W10 (⊙ or ⊗ refer to section 3.1.1)
- The design resistance can be used for the design according the partial safety concept, e.g. EN 1993-1-1 (Eurocode 3).
- Minimum edge distance = 6 mm [0.24"], spacing $\geq 15 \text{ mm [0.59"]}$
- Effect of base metal vibration and stress (e.g. areas with tensile stress) considered.
- Redundancy (multiple fastening) must be provided.
- If eccentric loading exists (e.g. use of an angle clip), moments caused by off-center loading must be considered.

Cyclic loading:

S-BT threaded studs are only to be used for fastenings subject to static or quasi-static loading.
Inquire at Hilti for test data if cyclic loading has to be considered in the design.

3.2.3 Recommended interaction formula for combined loading – steel and aluminum base materials

V-N (shear and tension) $\frac{V}{V_{rec}} + \frac{N}{N_{rec}} \leq 1.2$ with $\frac{V}{V_{rec}} \leq 1.0$ and $\frac{N}{N_{rec}} \leq 1.0$

V-M (shear and bending) $\frac{V}{V_{rec}} + \frac{M}{M_{rec}} \leq 1.2$ with $\frac{V}{V_{rec}} \leq 1.0$ and $\frac{M}{M_{rec}} \leq 1.0$

N-M (tension and bending) $\frac{N}{N_{rec}} + \frac{M}{M_{rec}} \leq 1.0$

V-N-M (shear, tension and bending) $\frac{V}{V_{rec}} + \frac{N}{N_{rec}} + \frac{M}{M_{rec}} \leq 1.0$

3.2.4 Base material thickness t_{II} and type of bore hole

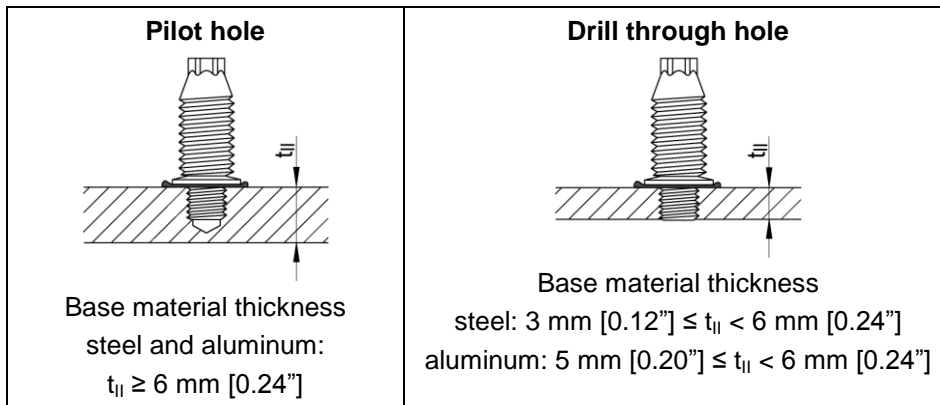

Thickness of base material corrosion protection layer $\leq 0.8 \text{ mm [0.0315"]}$.
For thicker coatings, please contact Hilti.

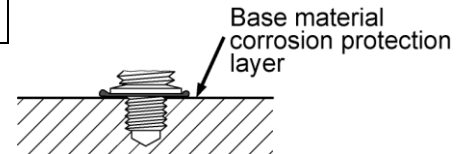

Corrosion information:

The S-BT stainless steel fasteners are made from the duplex stainless steel type 1.4462, which is equivalent to AISI 316 (A4) steel grade. This grade of stainless steel is classified in the corrosion resistance class IV according to DIN EN 1993-1-4:2015, which makes the material suitable for aggressive environments like in coastal and offshore applications.

The coating of the carbon steel S-BT fasteners consists of an electroplated Zn-alloy for cathodic protection and a top coat for chemical resistance (Duplex-coating). The maximum thickness of the coating is $35 \mu\text{m}$. The use of this coating is limited to the corrosion category C1, C2 and C3 according to the standard EN ISO 9223. For higher corrosion categories stainless steel fasteners should be used

In case of a **drill through hole**, rework of the coating on the back side of the plate / profile may be needed.

3.2.5 Thickness of fastened material t_f

S-BT-_____/7_____	$1.6 \text{ mm [0.063"]} \leq t_f \leq 7.0 \text{ mm [0.28"]}$
S-BT-_____/15_____	$1.6 \text{ mm [0.063"]} \leq t_f \leq 15.0 \text{ mm [0.59"]}$

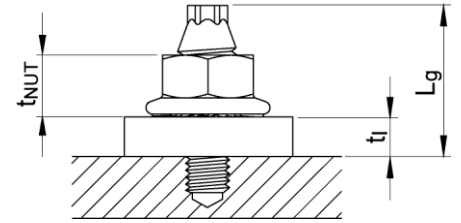

3.2.6 Spacing and edge distances

Edge distance: $\geq 6 \text{ mm [0.24"]}$ Spacing: $\geq 15 \text{ mm [0.59"]}$

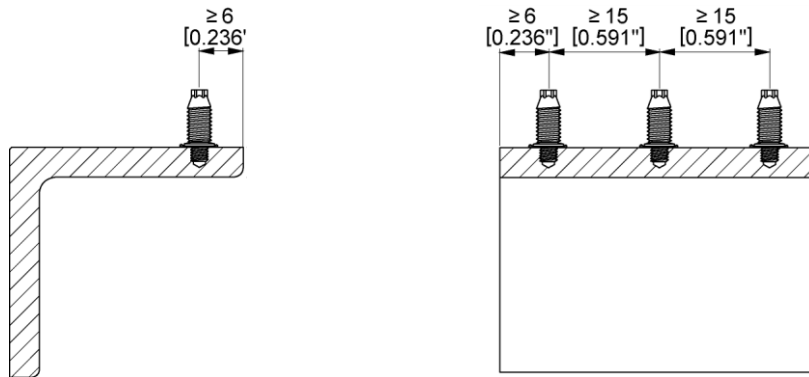

3.2.7 Application limit and thickness of base material

The base material is limited to steel grade with a maximum tensile strength $f_u = 630 \text{ MPa [91 ksi]}$.

The minimum tensile strength of steel is $f_u \geq 340 \text{ MPa [49 ksi]}$.

The minimum tensile strength of aluminum is $f_u \geq 270 \text{ MPa [39 ksi]}$.

Minimum thickness of base material t_{f1} : refer to section 3.2.4

Maximum thickness of base material t_{f1} : no limits

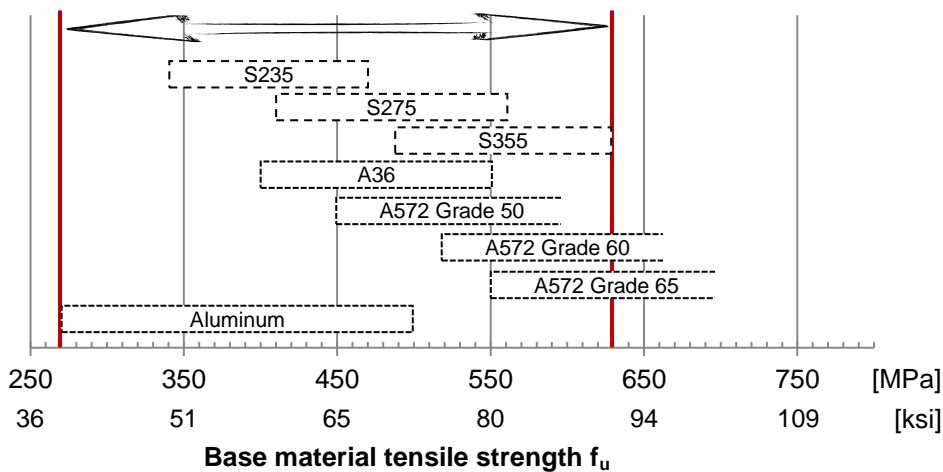

3.2.8 Fastening quality assurance and fastening inspection

Verify stud stand-off h_{NVS} with calibration card S-CG BT

S-BT-___/7___ 6 $h_{NVS} = 18.6 \text{ mm to } 19.1\text{mm [0.732" to 0.752"]}$

S-BT-___/15___ 6 $h_{NVS} = 29.3 \text{ mm to } 29.8\text{mm [1.153" to 1.173"]}$

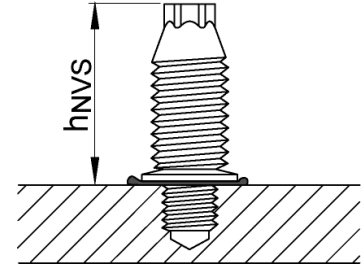

3.2.9 Fastener selection and system recommendation

	Fastener	Drilling Tool	Setting Tool	Drill bit	Depth gauge
Stainless Steel	S-BT-MR M8/7 SN 6	SF BT 18-A or SF BT 22-A	SFC 18-A or SFC 22-A	TS-BT 5.5-74 S	S-DG BT M8/7 Short 6
	S-BT-MR M8/7 SN 6 AL			TS-BT 5.5-74 AL	
	S-BT-MR M8/15 SN 6			TS-BT 5.5-74 S	S-DG BT M8/15 Long 6
	S-BT-MR M8/15 SN 6 AL			TS-BT 5.5-74 AL	
	S-BT-GR M8/7 SN 6			TS-BT 5.5-74 S	S-DG BT M8/7 Short 6
	S-BT-GR M8/7 SN 6 AL			TS-BT 5.5-74 AL	
	S-BT-MR M10/15 SN 6			TS-BT 5.5-74 S	S-DG BT M10-W10 Long 6
	S-BT-MR M10/15 SN 6 AL			TS-BT 5.5-74 AL	
	S-BT-MR W10/15 SN 6			TS-BT 5.5-74 S	
	S-BT-MR W10/15 SN 6 AL			TS-BT 5.5-74 AL	
Carbon Steel	S-BT-GF M8/7 AN 6			TS-BT 5.5-74 S	S-DG BT M8/7 Short 6
	S-BT-MF M8/7 AN 6				S-DG BT M8/15 Long 6
	S-BT-MF M8/15 AN 6				S-DG BT M10-W10 Long 6
	S-BT-MF M10/15 AN 6				
	S-BT-MF W10/15 AN 6				

3.2.10 Installation details

S-BT fastener made of stainless steel with washer-Ø 12mm (S-BT-_R)

Fastened material hole $\varnothing \geq 13 \text{ mm [0.51"]}$

S-BT fastener made of carbon steel with washer-Ø 10mm (S-BT-_F)

Fastened material hole $\varnothing \geq 11 \text{ mm [0.43"]}$

Remark: for group fastenings subjected to shear loading the fastened material hole diameter should not exceed 14 mm [0.55"] (S-BT-_R) and 12 mm [0.47"] (S-BT-_F) respectively.

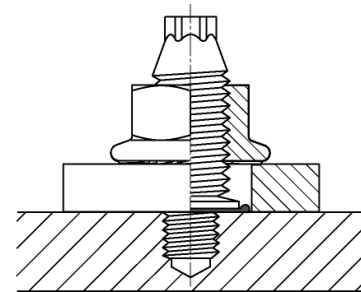

① **Mark location for each fastening**

② **Pre-drill with TS-BT stepped drill bit**

Usage of SF BT18-A or SF BT22-A. Pre-drill until the shoulder grinds a shiny ring to assure proper drilling depth.

Before fastener installation:

The drilled hole and the area around the drilled hole must be clear of liquids and debris.

③ **Screw-in S-BT studs into drilled hole**

Usage of SFC 18-A or SFC 22-A in combination with depth gauge S-DG BT.

Verify stud stand-off h_{NVS} with calibration card S-CG BT

Sealing washer must be properly compressed!



Shiny ring around the bore hole

- ④ **Hang channel or accessory on studs**
Tighten nuts by hand
- ⑤ **Tighten the nuts with the suited tightening torque T_{rec}**
 T_{rec} refer to table below.
 Tighten the serrated flange nuts using
 - SFC 18-A / 22-A with socket S-NS
 - torque tool X-BT 1/4" (8 Nm) or S-BT 1/4" (5 Nm)
 - torque wrench

	T_{rec}	
	5 Nm	8 Nm
Hilti screw driver:	Torque setting:	
SFC 18-A	4	5
SFC 22-A	4	5

Tightening torque serrated flange nut

	S-BT-_____6				
	Pilot hole, $t_{II} \geq 6 \text{ mm [0.24"]}$ Drill through hole, $5 \text{ mm [0.20]} \leq t_{II} < 6 \text{ mm [0.24"]}$			Drill through hole $3 \text{ mm} \leq t_{II} < 5 \text{ mm}$	
Base material	Steel S235 A36	Steel S355 Grade 50	Aluminum $R_m \geq 270$ N/mm ²	Steel S235 A36	Steel S355 Grade 50
Tightening torque serrated flange nut T_{rec} [Nm/lbft]	8 / 5.9	8 / 5.9	5 / 3.6	5 / 3.6	5 / 3.6

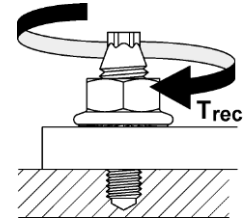

Important notes:

The tightening torque (T_{rec}) for the serrated flange nut is dependent on the stud type, the base material type and thickness, and the drill hole type. Exceeding the tightening torque (T_{rec}) leads to damage of the S-BT stud's anchorage with negative impact on the load values and the sealing function.

These are abbreviated instructions which may vary by application.
 ALWAYS review / follow the instructions for use (IFU) accompanying the product.
 In case of a **drill through hole**, rework of the coating on the back side of the plate / profile may be needed.

4 Method statement

4.1 Instructions for use – S-BT-MF M8/M10/W10 AN 6

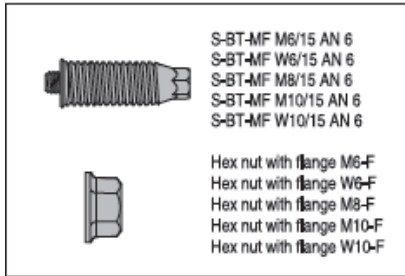
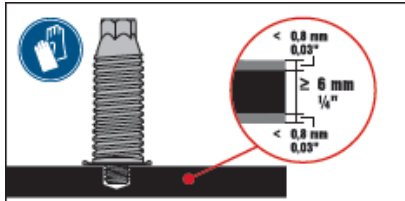

	SF BT 18 / 22-A
	TS-BT 5,5-74 S
	SFC 18 / 22-A
	S-DG BT M6 - W6 / 15 Long 6
	S-DG BT M8 / 15 Long 6
	S-DG BT M10 - W10 / 15 Long 6
	S-CC BT 6

	Torque tool X-BT 1/4 8 Nm / 5,9 ft.lb
--	--

	S-NS 10 C 95/3 3/4 (M6)
	S-NS 9/16 C 95/3 3/4 (W6)
	S-NS 13 C 95/3 3/4 (M8)
	S-NS 15 C 95/3 3/4 (M10)
	S-NS 9/16 C 95/3 3/4 (W10)

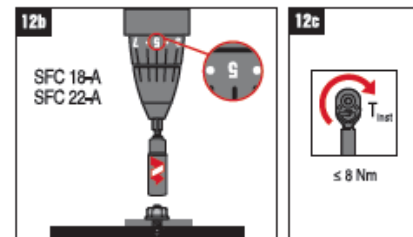
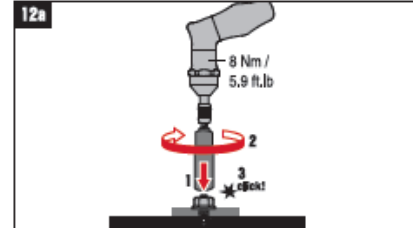
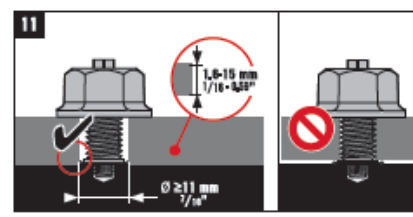
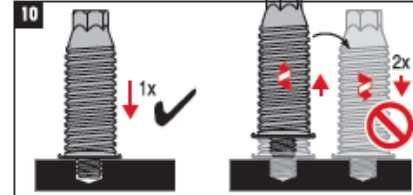
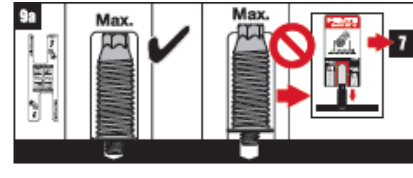
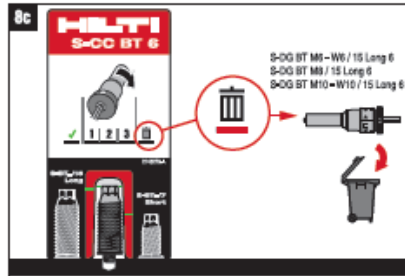
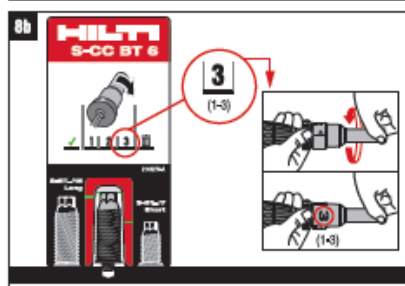
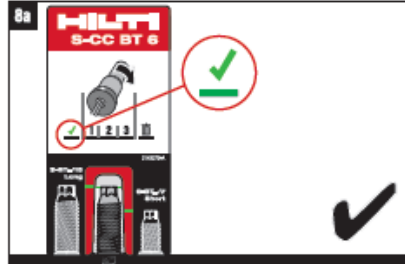
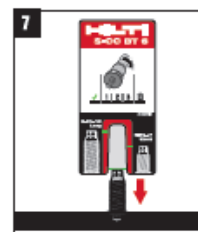
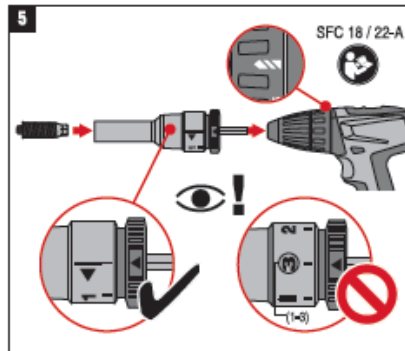
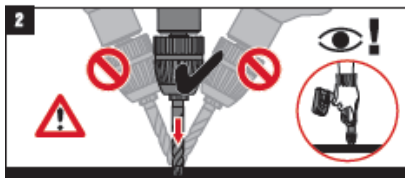
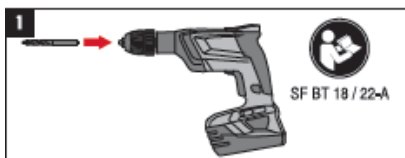

4.2 Instructions for use – S-BT-MF M8/7 AN 6 and S-BT-MR M8/7 SN 6

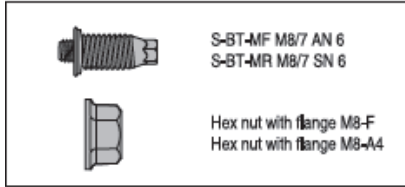
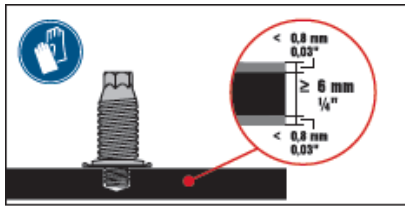

	SF BT 18 / 22-A
	TS-BT 5,5-74 S
	SFC 18 / 22-A
	S-DG BT M8/7 Short 6
	S-CC BT 6

Torque tool X-BT 1/4"
8 Nm / 5.9 ft.lb

S-NS 13 C 95/3 1/4"

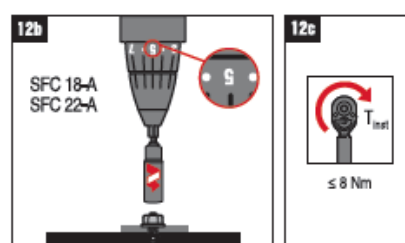
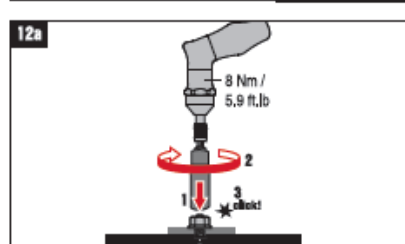
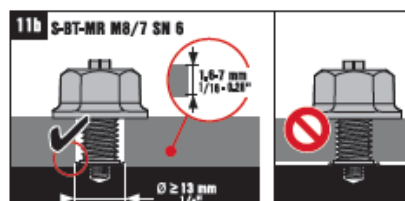
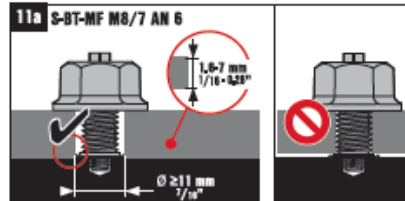
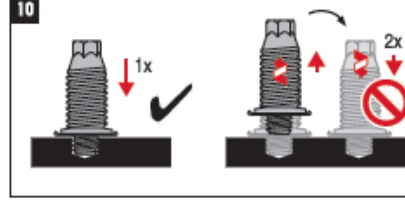
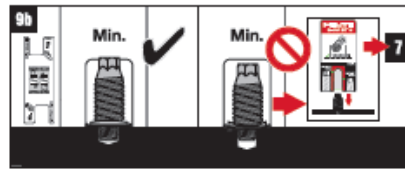
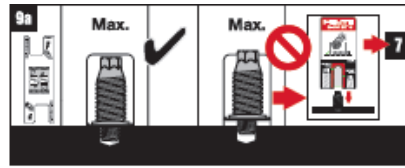
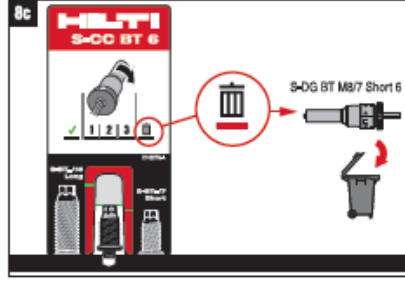
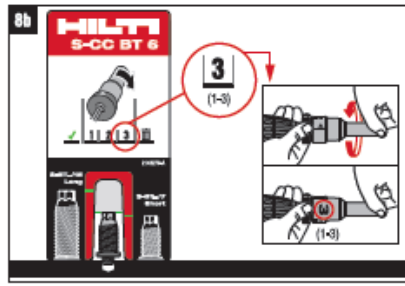
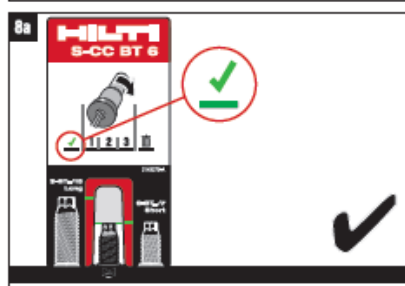
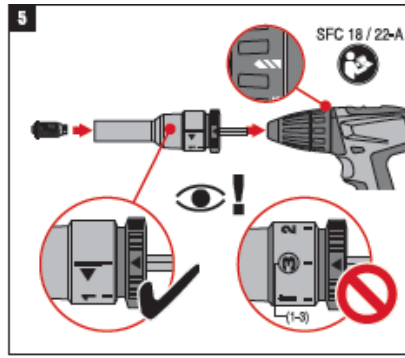
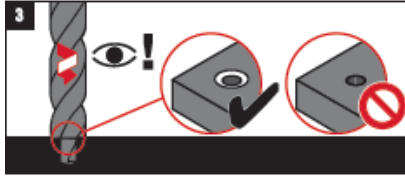
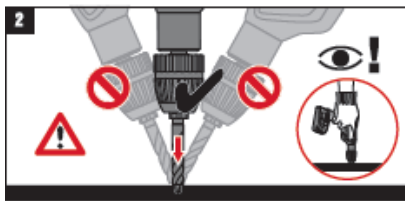

4.3 Instructions for use – S-BT-GF M8/7 AN 6 and S-BT-GR M8/7 SN 6

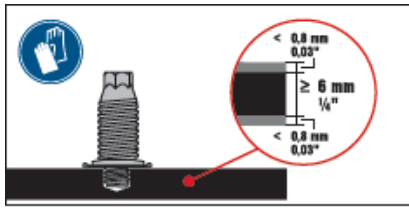

S-BT-GF M8/7 AN 6
S-BT-GR M8/7 SN 6

	SF BT 18 / 22-A
	TS-BT 5,5-74 S
	SFC 18 / 22-A
	S-DG BT M8/7 Short 6
	S-CC BT 6

Torque tool X-BT ¼"
8 Nm / 5,9 ft.lb

S-NS 13 C 95/3 ¼"

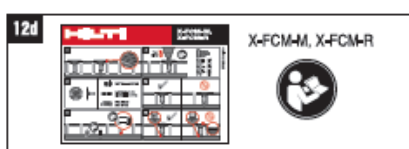
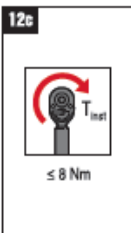
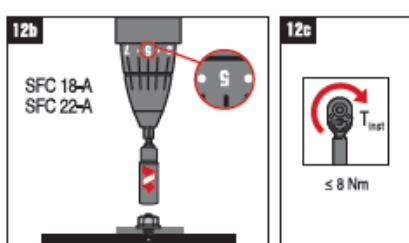
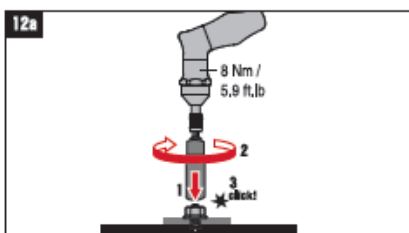
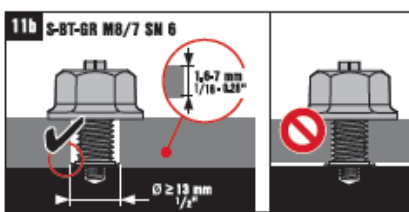
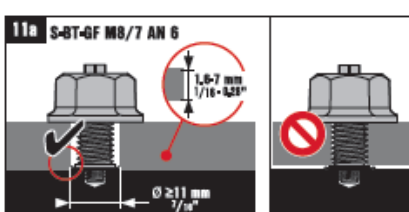
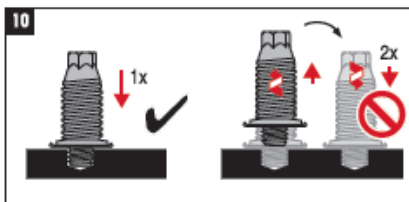
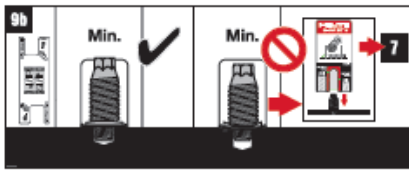
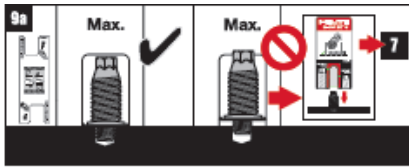
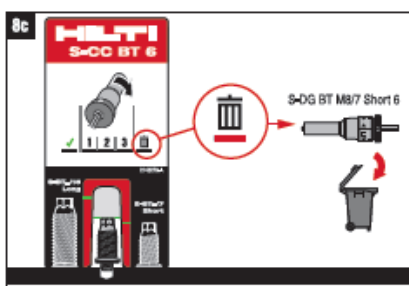
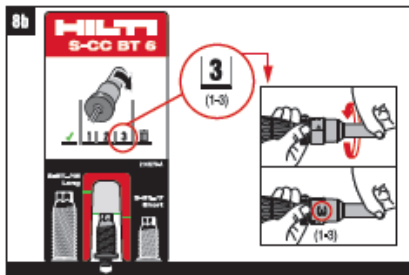
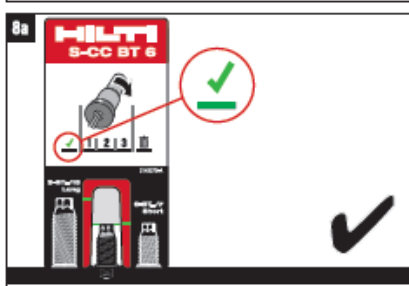
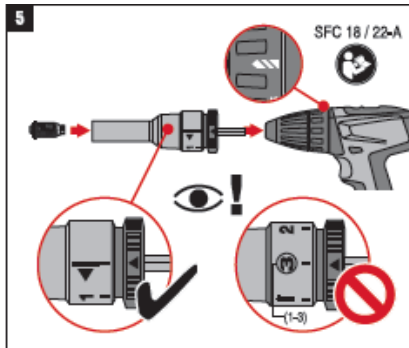
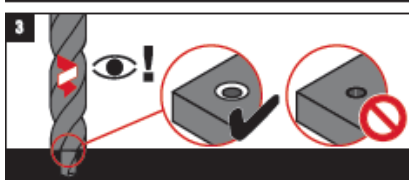
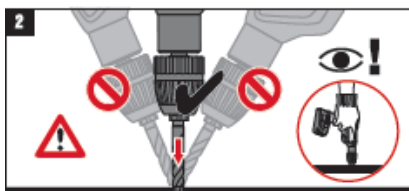

5 Performance

5.1 Nomenclature and symbols

The symbols and nomenclature used in the technical data are listed below.

Fastener test data and performance

N and V	Tensile and shear forces in a general sense
F	Combined force (resulting from N and V) in a general sense
N_S and V_S	Tensile and shear forces in a design calculation
F_S	Combined force (resulting from N_S and V_S) in a design calculation
N_u and V_u	Ultimate tensile and shear forces that cause failure of the fastening, statistically, the reading for one specimen
N_{u,m} and V_{u,m}	Mean ultimate tensile and shear forces that cause failure of the fastening, statistically, the average for a sample of several specimens
S	The standard deviation of the sample
N_{R,k} and V_{R,k}	Characteristic tensile and shear resistance of the fastening, statistically, the 5% fractile. For example, the characteristic strength of a fastening whose ultimate strength can be described by a standard Gauss type distribution is calculated by $N_{R,k} = N_{u,m} - k \times S$ where k is a function of the sample size, n and desired confidence interval.
N_{rec} and V_{rec}	Recommended maximum tensile and shear loads of the threaded fastener tip: $N_{rec} = \frac{N_{R,k}}{\Omega}$ and $V_{rec} = \frac{V_{R,k}}{\Omega}$ where Ω is the overall factor of safety
M_{rec}	Recommended elastic moment for the fastener shank $M_{rec} = \frac{M_{R,k}}{\Omega}$ where M_{R,k} is the characteristic elastic moment resistance of the threaded fastener tip and Ω is an overall factor of safety. Unless otherwise stated on the product data sheets, the M_{rec} values in this manual include a safety factor of "1.9" for static loading.
N_{R,d} and V_{R,d}	Design tensile and shear resistance of the fastening $N_{R,d} = \frac{N_{R,k}}{\gamma_m}$ and $V_{R,d} = \frac{V_{R,k}}{\gamma_m}$ where γ_m is the partial factor of safety
T_{rec}	Recommended tightening torque [Nm or lbf·ft]

Fastening details

h_{ef}	Screw-in depth of the threaded fastener tip below the surface of the base material
h_{NVS}	S-BT stud head stand-off above the surface of the base material
t_i	Thickness of the fastened material
t_{II}	Thickness of the base material
Σ t_i	Total thickness of the fastened material (where more than one layer is fastened)
t_{Nut}	Thickness of the serrated flange nut

Characteristics of steel and other metals

f_y	Yield strength of metals [N/mm ² or MPa]
f_u	Ultimate tensile strength of metals [N/mm ² or MPa]

5.2 Design concepts

The recommended working loads N_{rec} and V_{rec} are generally suitable for use in typical working load designs.

Working load concept

$$N_S \leq N_{rec} = \frac{N_{R,k}}{\Omega}$$

where Ω is an overall factor of safety including allowance for:

- errors in estimation of load
- deviations in material and workmanship

and N_S is, in general, a characteristic acting load.

$$N_S \approx N_{S,k}$$

Partial safety concept

$$N_{S,d} \leq N_{R,d}$$

$$N_{S,d} = N_{S,k} \times \gamma_F$$

$$N_{R,d} = \frac{N_{R,k}}{\gamma_M}$$

where γ_F is a partial factor of safety to allow for errors in estimation on the acting load.

γ_M is a partial factor of safety to allow for deviations in material and workmanship.

Working load concept

Partial safety concept

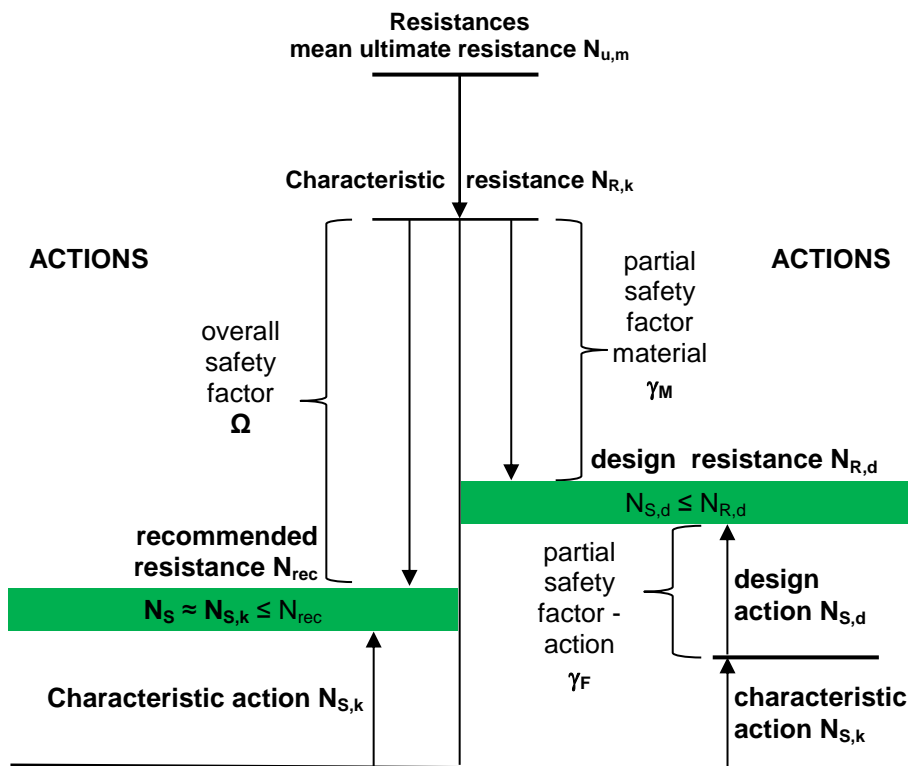

5.3 Static capacity of the S-BT threaded stud

5.3.1 Tensile load deformation behavior of S-BT threaded stud fastenings

Tension, shear and bending tests with S-BT screw-in threaded studs,
Report No. 279/15 HTL Rankweil, Bautechnische Versuchsanstalt, Febr. 2016

Base material	Steel, 6mm thick, S235 ($f_u \approx 360$ MPa)
	S355 ($f_u \approx 470$ MPa)
	Steel, 5mm thick, S235 ($f_u \approx 360$ MPa)
	S355 ($f_u \approx 470$ MPa)
	Steel, 3mm thick, S235 ($f_u \approx 360$ MPa)
	S235 ($f_u \approx 360$ MPa)
Aluminum, 6mm thick, EN AW 5754 ($f_u \approx 270$ MPa)	

Number of fastenings in test	90
	50 in steel S235
	30 in steel S355
	10 in Aluminum

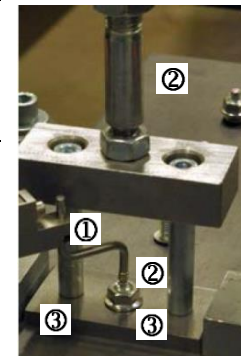
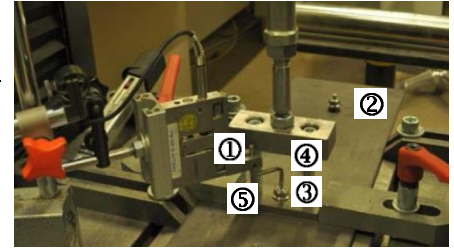

- ① Displacement gauge
- ② Base material
- ③ S-BT stud
- ④ Nut
- ⑤ Loading plate

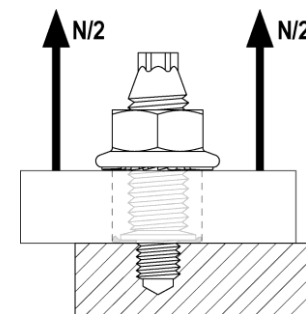
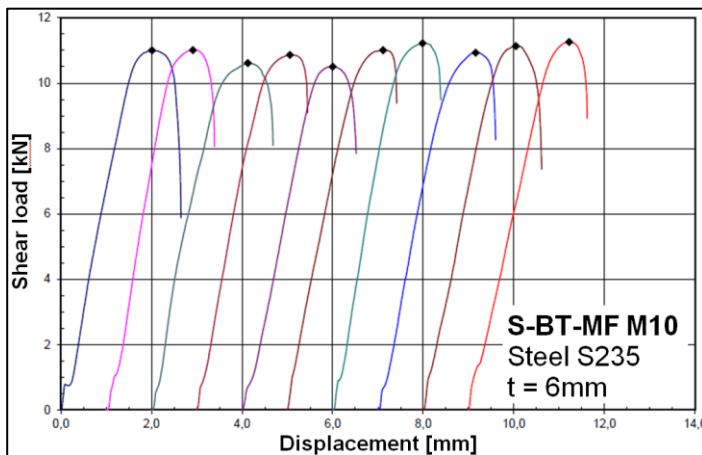
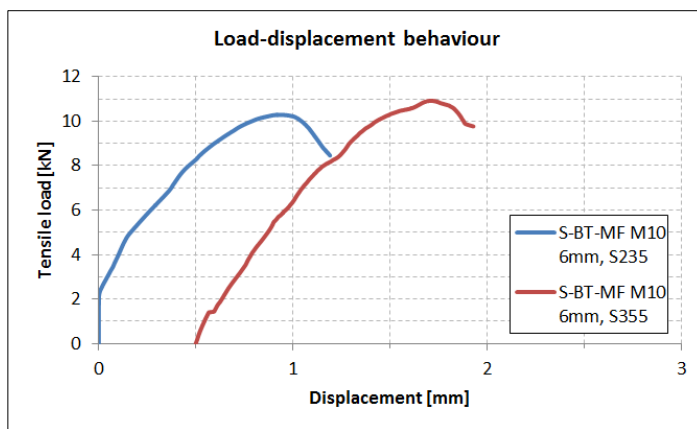

Conclusions

- Pull out strength increases with increasing base material strength and screw-in depth
- The fasteners show a well-tempered elastic behavior with a maximum displacement from 1 – 2.8 mm until the maximum load value is reached.
- Elastic stiffness is independent from the base material strength. It depends on the fastener material and base material thickness. Carbon steel fasteners behave a little stiffer than stainless steel fasteners.
- After the maximum loading capacity of the fastener is reached, no remaining load value is left due to the pull out of the tapped thread of the base material.

5.3.2 Pull out strength of S-BT threaded stud fastenings

Tension, shear and bending tests with S-BT screw-in threaded studs,
Report No. 279/15 HTL Rankweil, Bautechnische Versuchsanstalt, Febr. 2016

Base material ref. to 5.3.1

Number of fastenings in test ref. to 5.3.1

Ultimate pull-out load

The effect of the base material type, strength and base material thickness (screw-in depth) can be observed.

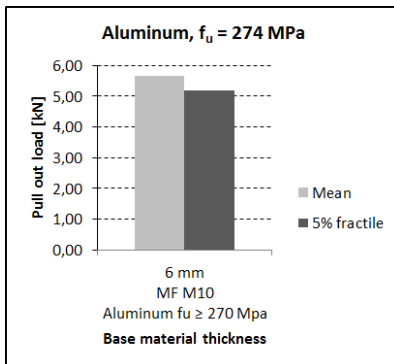
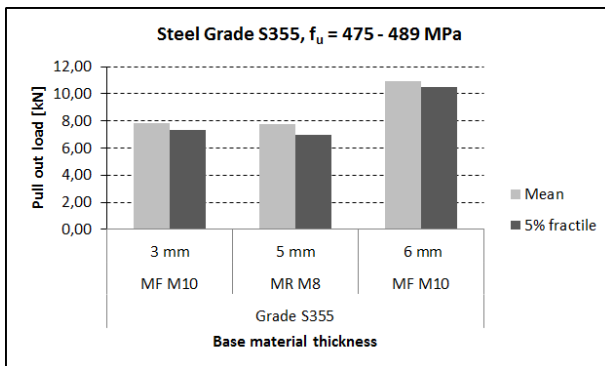
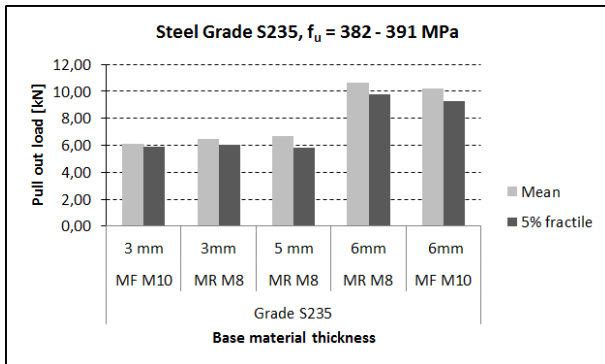
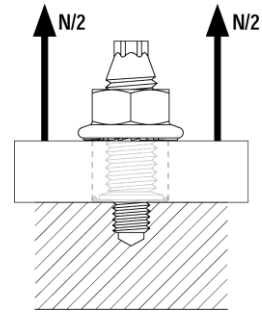

Test set up for tension tests

Conclusions

- The failure mode for all tensile tests was pull out of the fastener from the bore hole.
- The effect of the base material strength is given for all tested base metal thickness.
- The most important parameter affecting the pull out strength is the screw-in depth and the type of the base material (steel vs. aluminum).
- The thread size of the upper part of the fastener doesn't affect the pull out load value because the geometry of the tapping thread is identical for all studs made of the same material.

5.3.3 Shear strength of S-BT threaded stud fastenings

Tension, shear and bending tests with S-BT screw-in threaded studs,
Report No. 279/15 HTL Rankweil, Bautechnische Versuchsanstalt, Febr. 2016

Base material ref. to 5.3.1

Number of fastenings in test ref. to 5.3.1

Ultimate shear load

The shear failure occurs through breakage of the stud in the cross section of the tap thread or through plastic deformation of the hole in the base material which leads to tilting and pull-out of fastener.

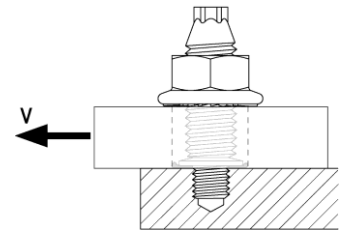

Test set up for shear load testing

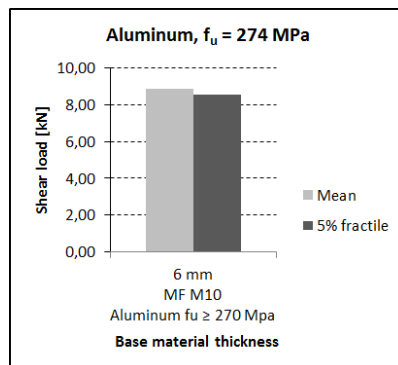
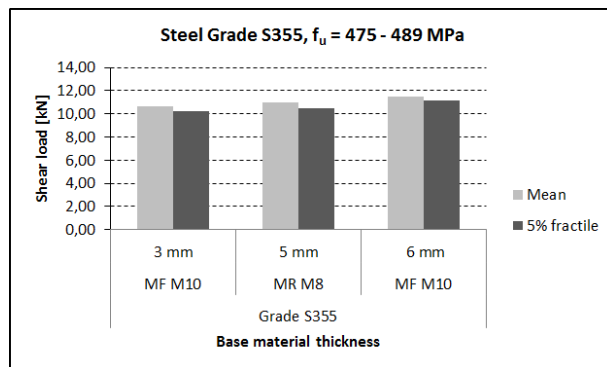
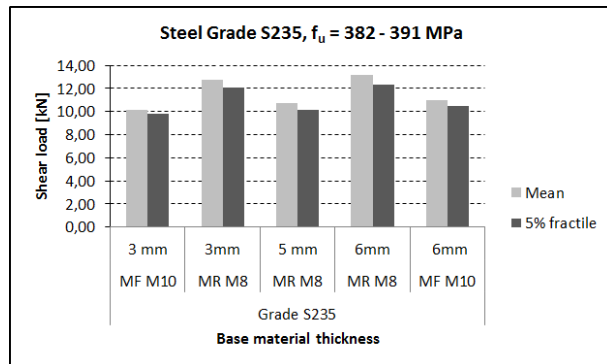

Conclusions

- Failure mode of the tested S-BT studs:
85% failed due to shear fracture in the cross section of the tap thread
15 % failed due to plastic deformation of the bore hole \Rightarrow tilting \Rightarrow pull-out
- The effect of the steel base material strength is rather low.
- The most important parameters affecting the shear load capacity is the screw-in depth, the type of the base material (steel vs. aluminum) and the material of the S-BT stud.
- The thread size of the upper part of the fastener doesn't affect the shear load capacity because the geometry of the tapping thread is identical for all studs made of the same material.

5.4 Vibration effects on S-BT threaded stud fastenings

Experimental investigations on the effect of base metal vibrations on the ultimate pull-out

Report No. XSEhac-01-15_07; Hilti AG; Schaan 2015

Base material:	Steel, S235
Beam section:	HEA 100, 8 mm flange, 5 mm web
Beam span:	720 mm
Test procedure:	Beam loaded in center with F_{max} / F_{min} Step 1: $F_{max} = 59 \text{ kN}$, $F_{min} = 22 \text{ kN}$ Frequency = 6 Hz, 2 Million cycles Step 2: $F_{max} = 59 \text{ kN}$, $F_{min} = 7 \text{ kN}$ Frequency = 6 Hz, 0.5 Million cycles Step 3: $F_{max} = 10 \text{ kN}$, $F_{min} = -10 \text{ kN}$ Frequency = 30 Hz, 1.5 Million cycles Step 4: $F_{max} = 2.5 \text{ kN}$, $F_{min} = -2.5 \text{ kN}$ Frequency = 60 Hz, 5 Million cycles
Number of fastenings:	32 S-BT M8 in with FCM-disc "Grating" 32 S-BT M10 in with MQ-Channel "Multipurpose"

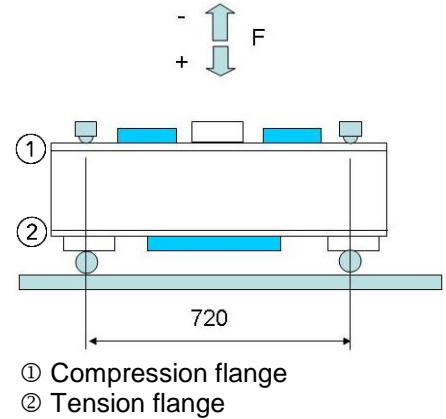

Ultimate pull-out loads of S-BT fasteners before and after cyclic loading of the steel beam

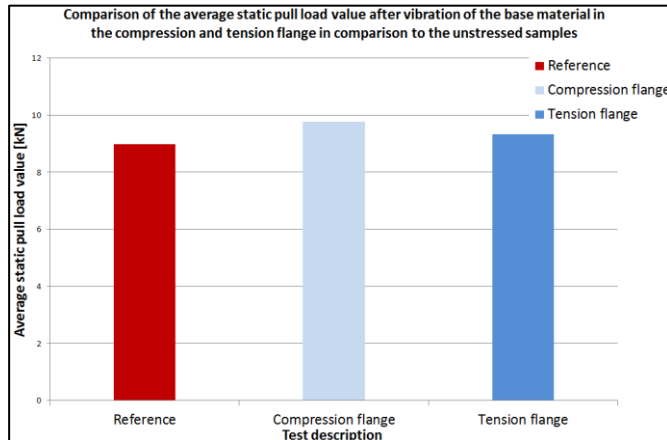

Conclusions

- Tension flange: The ultimate pull load value after the vibration test is on the same level compared to the unstressed value. No negative influence visible.
- Compression flange: The ultimate pull load value in the compressed flange is slightly higher compared to the tension flange. This could be an indicator for solidification of the thread in the compression.
- Cyclic loading applied to steel beams, which causes vibration on the fastener, as tested above did not result in loosening of grating X-FCM grating discs or loosening of S-BT studs.

Notes

- The specific test parameters and range, as detailed above, were chosen to be representative of most common vibration cases as they may occur at installation sites.
- This summary is not a complete representation of the wide range of possible vibration conditions as they may occur at specific sites. Once vibration conditions are outside this range, further verifications will be required before a clear statement can be given.

This summary is intended to be representative of the test(s) carried out. It is not intended to be a full and complete test report.



Multipurpose application



Grating application



Markings to measure disc rotation

5.5 Resistance of S-BT fastenings under dynamic tensile loading

Report No. XSEhac-01-15_06; Hilti AG; Schaan 2015

General comments

The tests were performed to investigate the effect of repeated tensile loads on the anchorage of the S-BT fastenings. Therefore Wöhler charts for S-BT fastenings have been evaluated in view of the resistance of vibrations in axial direction (repeated tensile loads).

Test concept

The S-BT fasteners were subjected to a harmonic pulsating tensile loading. The minimal load of the harmonic loading was 0.2 kN in all tests. Tests were performed at 4 different load levels. The applied maximal loads were 1.8, 3.6, 4.5 and 5.4 kN. Tests were stopped if no failure occurred within 10 million load cycles. As a testing frequency 50 Hz were chosen.

The tests were performed on the upper application limit for the base material strength (European Grade S355 with an ultimate tensile strength $f_u = 630$ MPa) in combination with a minimum thread intersection of 0.2 mm. Minimum thread intersection is defined as the lowest tolerance field of the stud thread engagement with the base material, ref. to figure in section 5.7.

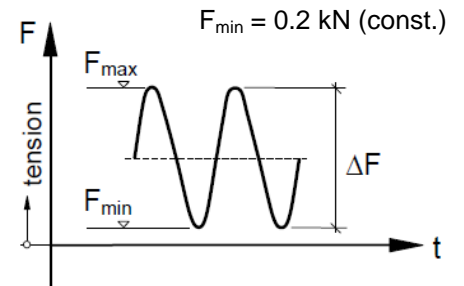
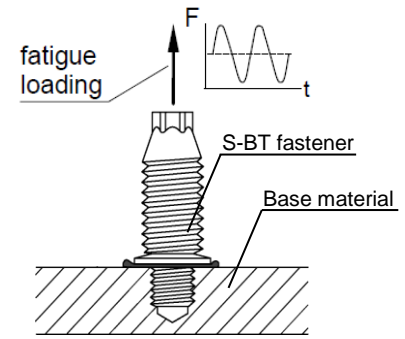

Test results

	Level	# tests	F_{max} [kN]	F_{min} [kN]	σ_{max} [N/mm ²]	σ_{min} [N/mm ²]	σ_{mean} [N/mm ²]	σ_a [N/mm ²]	$\Delta\sigma$ [N/mm ²]	Ratio R	Cycles N	Fail	Pass
Stainless steel 1.4462	1	5	1.8	0.2	115	12.8	63.9	51.1	102.2	0.11	12'000'000		✓
											16'000'000		✓
											12'000'000		✓
											12'000'000		✓
											11'000'000		✓
	2	5	3.6	0.2	230	12.8	121.4	108.6	217.2	0.06	2'246'724	Rupture	
											11'706'502		✓
											12'675'924		✓
											10'000'000		✓
											10'000'000		✓
	3	5	4.5	0.2	288	12.8	150.4	137.6	275.2	0.04	294'040	Pull out	
											918'680	Pull out	
											4'655'463	Rupture	
											5'617'125	Pull out	
											9'38'2038	Rupture	
	4	5	5.4	0.2	346	12.8	179.4	166.6	333.2	0.04	1'775'555	Rupture	
788'133											Rupture		
620'386											Rupture		
10'000'000												✓	
3'141'580											Rupture		

Principle sketch of cyclic tension tests

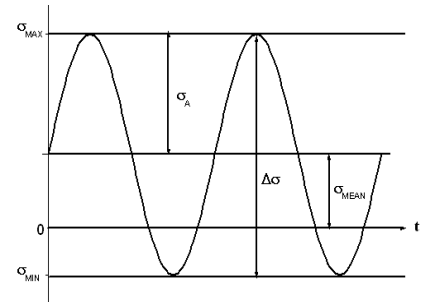

Test results of fatigue tests with S-BT fasteners (1.4462) loaded with harmonic pulsating tensile loads

The intended maximum recommended tensile load of S-BT fasteners in steel S355 amounts to 2.3 kN ($\sigma_{max} = 147$ N/mm²). Therefore, tests were performed around this load to assess the fatigue resistance under service load conditions. At level 1 all samples passed the load level of 1.8 kN. At the second level 4 out of 5 samples passed the load level of 3.6 kN. Consequently, higher maximal loads were applied to increase the probability of failure. At level 3 and 4 the majority of the samples failed.

In all tests the governing failure mode was fatigue fracture of the S-BT stud or pull out from the base material.

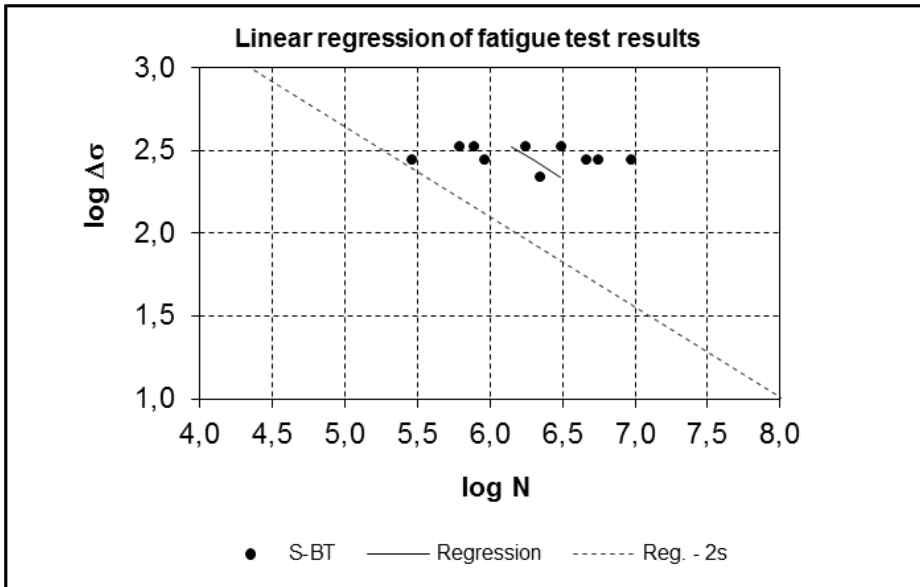

Test setup for cyclic tension tests

Linear regression of fatigue test results

As often done in fatigue design, the characteristic resistance $\Delta\sigma_k$ (= 5%-fractile or 95% probability of survival) is assessed by reducing the linear regression with the double of the standard deviation “s” of the test data. “s” corresponds to the standard deviation of the difference between the test results and the mean trend.

Applying this procedure, the characteristic fatigue strength determines to:

$$\log N_k = 9.8626 - 1.8396 \cdot \log \Delta\sigma_k$$

Load N_{rec} [kN]	Cycles N_k [-]	$\Delta\sigma$ [N/mm ²]	log $\Delta\sigma$ [-]	log N_k [-]	Comment
1.8	1'175'000	115	2.062	6.070	
2.3	748'000	147	2.168	5.874	$N_{rec} = 2.3$ kN for S355 / Grade 50 steel

Characteristic cycle life N_k at tension service load level N_{rec}

Conclusions

- The values given in the table can be used for fatigue design of the stainless steel S-BT fasteners in steel grade S355 / Grade 50.
- In case fatigue design with higher load cycles beyond 1'175'000 cycles is required, the characteristic fatigue design curve (Reg. – 2s) can be conservatively used.
- The results presented allow the use of S-BT-fasteners in applications, where wind suction is involved or to cover many typical "dynamic" parts of in principle static working loads.
- If high cycle fatigue design is necessary, the corresponding characteristics can be used to assess the principle suitability of S-BT fasteners for the specific purpose. Nevertheless, high cycle fatigue design is beyond the scope of the S-BT fasteners.

Note:

- In case of static loading, sufficient redundancy of the entire fastening must be provided.
- The values stated apply for axial tensile loading. The constructive detail has to be checked with regards to this condition. If bending stresses – for example due to imperfections – might occur, these have to be considered in fatigue design. Imperfections will lead to a reduction of the characteristic cycle lives.

- The partial safety factors for fatigue actions as well as fatigue resistance have to be considered according to fatigue design provisions (for example: Eurocode 4 or AISC-LRFD) in agreement with the statistical evaluation of N_k .
- If global safety concepts are applied, the global factors of safety have to be taken in agreement with the statistical evaluation of N_k meeting the conditions of the used design standard.

This summary is intended to be representative of the test(s) carried out. It is not intended to be a full and complete test report.

5.6 Influence of the S-BT on the fatigue strength of structural steel

When using Hilti S-BT fasteners in combination with structural steel elements that are subjected to cyclic loading, the effect of the fastener on the fatigue strength of the steel base material has to be considered. It is therefore necessary to define a proper fatigue strength classification for the corresponding structural detail shown aside. Beginning of 2016 Hilti defined a test program to investigate how the presence of S-BT fasteners affects the fatigue strength of the base material. At the moment the tests are running at the Swiss Federal Laboratories for Material Testing and Research (EMPA) in Dübendorf. The assessment of the tests results will be done by MPA Stuttgart, Otto-Graf-Institut.

Based on these experimental investigations, Hilti will provide a recommendation for a fatigue classification of the corresponding detail in compliance with the provisions given in Eurocode 3 (EN 1993-1-9:2005) by evaluation of the performed fatigue tests and through comparison with existing fatigue tests on other similar Hilti fastening systems.

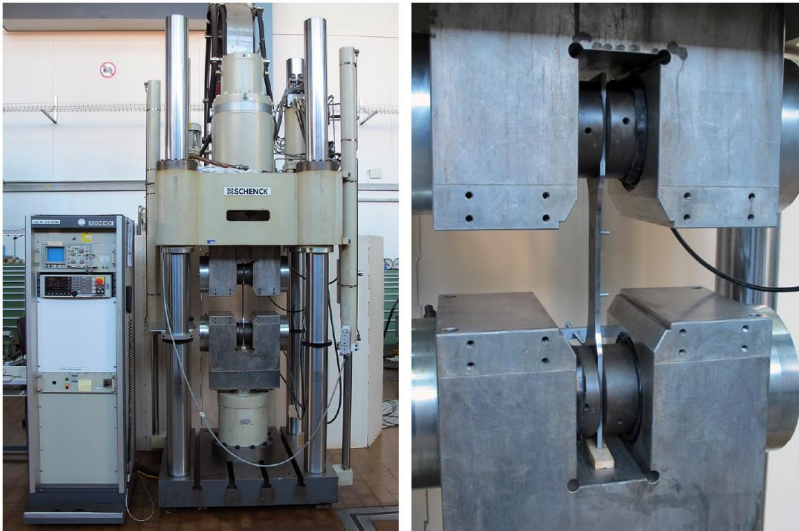
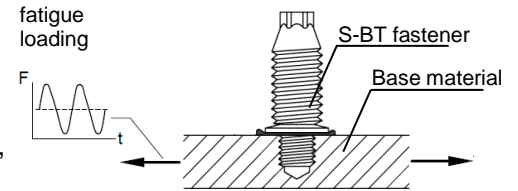

Test facility for fatigue test

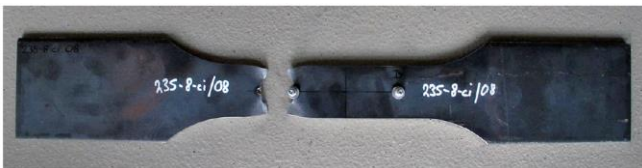

Specimen for fatigue test

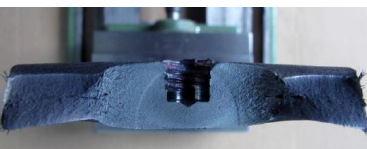

Fracture surface

5.7 Influence of glue coatings on the loosening torque

Experimental investigations on the influence of glue coatings on the loosening torque

Report No. XSEhac-01-15_15; Hilti AG; Schaan 2015

General comments

The design intent is that the nut can be removed without the S-BT stud unscrewing from the base material. To increase the loosening torque of the stud from the base material, the stainless steel and carbon steel S-BT fasteners are equipped with a “micro encapsulation” Pre-cote 80-8 on the tapping thread. This helps to increase the loosening torque compared to uncoated fasteners.

Test concept

The test program included in summary 100 specimen for 20 test series. Various coating types have been tested in combination with variable thread intersections. The influence of the screw-in depth was tested for the complete screw-in depth range of the S-BT fastener. As a final parameter, the influence of the maximum and minimum base material strength was tested.

Test results

Thread intersection: For all tested thread intersections an increase of the loosening torque was visible due to the coating.

Screw-in depth: Based on the test results, the effect of the glue coating decreased with lower screw-in depth.

Base material strength: No significant influence could be found.

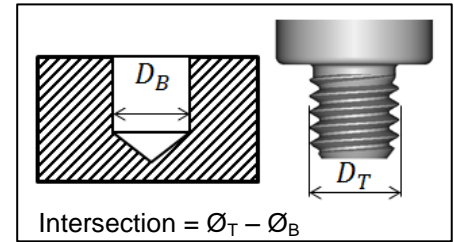

Definition of the thread intersection

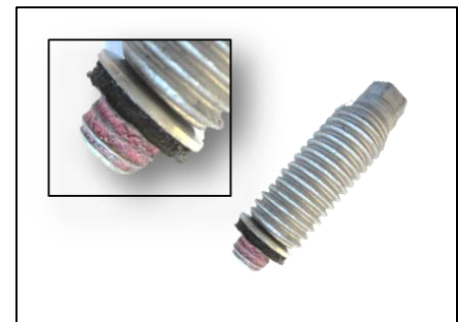

Micro encapsulation on the tapping thread of the S-BT fastener

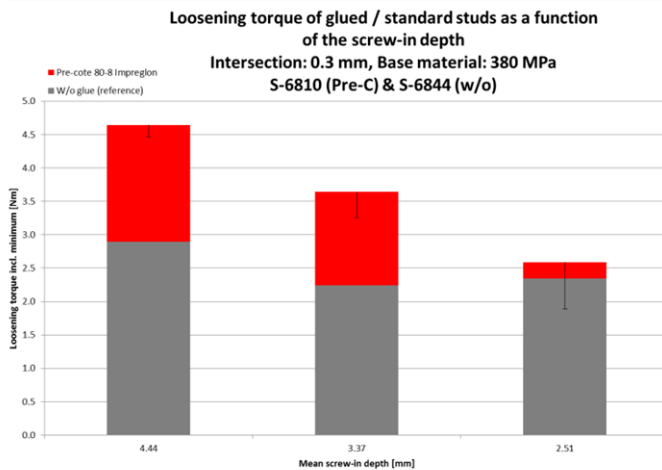

Micro encapsulation on the tapping thread of the S-BT fastener

Conclusions

For 6 mm base material, a loosening torque of 3.6 to 4.6 Nm can be achieved. For 5 mm base material, a loosening torque of 2.5 to 3.6 Nm can be achieved. Reusing the stud is prohibited due to the wear of “micro encapsulation” pre-cote 80-8, and potential thread wear.

Note: The “micro encapsulation” has no impact on the pull out load capacity of the S-BT fastener. The application temperature range for pre-cote 80-8 is -60°C up to +170°C.

The installation temperature of the base material must be > -20°C (for the curing process of the glue coating).

5.8 Corrosion resistance

5.8.1 Selection of a suitable fastener

If a fastening has to be perfectly satisfactory and reliable for its entire service life, all surrounding conditions must be ascertained before a suitable fastener can be selected.

Therefore, it is necessary to take into account where the parts are installed, indoor or outdoor. For outdoor applications, a distinction is made between rural, urban, industrial and marine atmospheres. Nevertheless, there are special applications like waste water treatment plants, industrial installations, road tunnels and swimming pools. In view of this, each application must be evaluated separately and the findings must be considered when selecting a material with the required corrosion behavior or a system that provides adequate corrosion protection.

When material combinations are used, an evaluation of their electrochemical behavior has to be performed to avoid contact corrosion.

Note: The information in the following section may be of assistance as it provides some important points that aid selection. The table, however, cannot cover all individual aspects for each application.

The ultimate decision on the required corrosion protection must be made by the customer. Hilti accepts no responsibility regarding the suitability of a product for a specific application, even if informed of the application conditions. The tables are based on an average service life for typical applications. For metallic coatings, e.g. zinc layer systems, the end of lifetime is the point at which red rust is visible over a large fraction of the product and widespread structural deterioration can occur – the initial onset of rust may occur sooner.

		Fastener	
		Carbon steel S-BT-MF S-BT-GF	Stainless steel S-BT-MR S-BT-GR
	Coating / material	Duplex-coated carbon steel	A4 AISI 316
Environmental conditions	Fastened part		
Dry indoor	Steel (zinc-coated, painted), aluminum, stainless steel	■	■
Indoor with temporary condensation	Steel (zinc-coated, painted), aluminum stainless steel	■ -	■
Outdoor with low pollution	Steel (zinc-coated, painted), aluminum stainless steel	□ ¹⁾ -	■
Outdoor with moderate concentration of pollutants	Steel (zinc-coated, painted), aluminum stainless steel	□ ¹⁾ -	■
Coastal areas	Steel (zinc-coated, painted), aluminum, stainless steel	-	■
Outdoor, areas with heavy industrial pollution	Steel (zinc-coated, painted), aluminum, stainless steel	-	■
Close proximity to roads	Steel (zinc-coated, painted), aluminum, stainless steel	-	■
Special applications	Consult experts		

- = expected lifetime of S-BT fasteners made from this material is typically satisfactory in the specified environment based on the typically expected lifetime of a building.
 - = a decrease in the expected lifetime of non-stainless fasteners in these atmospheres must be taken into account (≤ 25 years). Higher expected lifetime needs a specific assessment.
 - = S-BT fasteners made from this material are not suitable in the specified environment. Exceptions need a specific assessment.
- ¹⁾ From a technical point of view, duplex coatings are suitable for outdoor environments with certain lifetime and application restrictions. This is based on long-term experience with these materials as reflected e.g. in the corrosion rates for Zn given in the ISO 9224:2012 (corrosivity categories, C-classes).

Important notes:

National or international codes, standards or regulations, customer and/or industry specific guidelines must be independently considered and evaluated. These guidelines apply to atmospheric corrosion only. Special types of corrosion, such as crevice corrosion must be independently evaluated. The tables published in this brochure describe only a general guideline for commonly accepted applications in typical atmospheric environments.

Suitability for a specific application can be significantly affected by localized conditions, including but not limited to:

- Elevated temperatures and humidity
- High levels of airborne pollutants
- Direct contact with corrosive products, such as found in some types of chemically-treated wood, waste water, concrete additives, cleaning agents, etc.
- Direct contact to soil, stagnant water
- Direct contact to fresh/young concrete (less than 28 days old)
- Electrical current
- Contact with dissimilar metals
- Confined areas, e.g. crevices
- Physical damage or wear
- Extreme corrosivity due to combined effects of different influencing factors
- Enrichment of pollutants on the product
- Nature of fastening part: fastener must be made of a more noble material or the same material than the fastened part

5.8.2 Galvanic (contact) corrosion

Galvanic corrosion refers to corrosion damage where two dissimilar metals have an electrically conducting connection and are in contact with a common corrosive electrolyte.

Generally, the less noble metal will be dissolved (anodic metal dissolution), whereas the more noble part is not attacked by corrosion (serves only as the cathode for oxygen reduction). Where galvanic corrosion takes place, the rate of corrosion of the less noble metal is higher than it would be in a free corroding environment without contact to another metal.

Galvanic corrosion can be avoided by the right choice of material combinations. To minimize galvanic corrosion, the difference in free corrosion potential between the materials should be as low as possible, and/or the surface ratio of less noble metal to nobler metal should be very high. The free corrosion potential depends on the standard potential, a given thermodynamic value for each metal and the corrosive environment.

As a general rule of thumb, a fastener should always be made of the same or a more noble metal than the part to be fastened in order to prevent failure of the fastener. The fastener typically has the smaller surface area.

The following table shows the impact of galvanic corrosion under atmospheric **outdoor conditions** for various material combinations.

In **dry indoor applications** contact corrosion can be neglected and usually there are no susceptible material combinations.

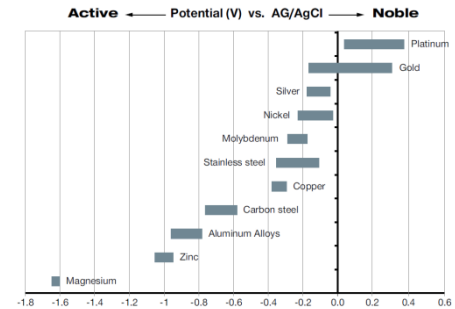
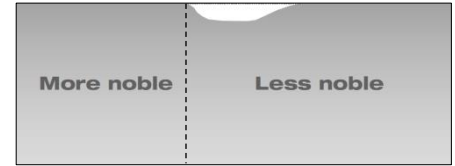

Corrosion potential of various metals in sea water

Fastened part (large area)	Fastener (small area)	
	Carbon steel (Duplex-coated) S-BT-MF S-BT-GF	Stainless steel S-BT-MR S-BT-GR
Electrogalvanized	□	□
Hot-dip galvanized	□	□
Aluminum	■	□
Structural or cast steel	■	□
Stainless steel (CrNi or CrNiMo)	■	□
Tin	■	□
Copper	■	□
Brass	■	□

- No impact on lifetime
- moderate impact on lifetime, technically accepted in many cases
- strong impact on lifetime

Impact on lifetime of the S-BT fastener by galvanic (contact) corrosion



This is a typical case of contact corrosion. Zinc-plated carbon steel (washer) and stainless steel (screw and part) were used together. The surface area of the more noble metal – the stainless steel – is larger, causing strong corrosion of the washer.

5.8.3 Carbon steel S-BT studs

General comments

The coating of the carbon steel S-BT fasteners consists of an electroplated Zn-alloy for cathodic protection and a top coat for chemical resistance (Duplex-coating). The maximum thickness of the coating is 35 µm. The use of this coating is limited to the corrosion category C1, C2 and C3 according the standard EN ISO 9223. For higher corrosion categories stainless steel fasteners should be used.

Thanks to extensive research in close cooperation with renowned universities and laboratories, designers can trust and rely on the multilayer coating for S-BT.

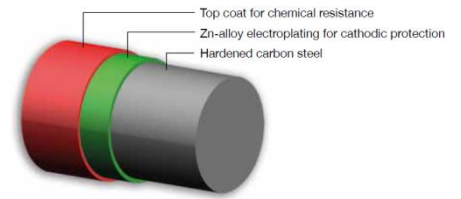

Duplex-coating on carbon steel S-BT fasteners

Indoor applications	
	Dry indoor environments (heated or air-conditioned areas) without condensation, e.g. office buildings, schools
	Indoor environments with temporary condensation (unheated areas without pollutants), e.g. storage sheds
Outdoor applications	
	Outdoor, rural or urban environment with low pollution Large distance (> 10 km) from the sea
	Outdoor, rural or urban environment with moderate concentration of pollutants and/or salt from sea water Distance from the sea 1-10 km

Environmental conditions for usage of coated carbon steel S-BT studs

Test concept

Laboratory and field tests are performed to assess the expected lifetime and technical safety aspects for fasteners. The duplex coating on the S-BT was tested in neutral salt spray according to DIN EN ISO 9227, which is the most commonly used accelerated corrosion test for corrosion assessment. This test is suitable for quality assessment but does not reflect real environmental conditions. In contrast, cyclic corrosion tests like ISO 16701 reproduce and accelerate corrosion mechanisms that occur under real environmental conditions. This test is well adapted for lifetime assessment under moderate atmospheric conditions. The fasteners are subjected through cycled climate conditions such as temperature variations, humidity and dry periods as well as corrosion attack through salt. Results of laboratory tests are verified by mid- and long term field tests in natural climatic conditions.

During the setting process, the fastener is subjected to strong impacts. To ensure that the corrosion resistance of the S-BT remains intact, Hilti performs all corrosion tests on S-BT in mounted condition and the fasteners are installed in steel plates with the necessary tools.

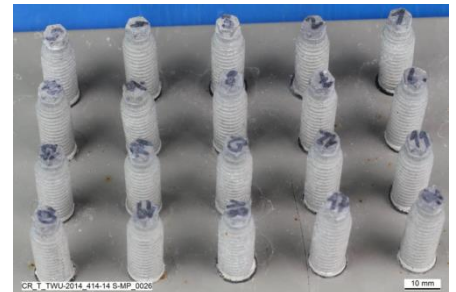

Prepared S-BT fastenings



Removed S-BT fasteners after 12 weeks EN ISO 16701 cyclic corrosion test. No visible corrosion.

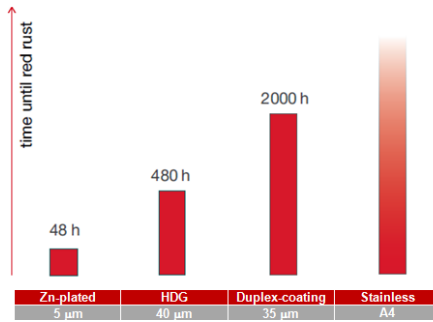

Neutral salt spray test

S-BT studs with duplex-coating are subjected to a neutral salt spray test according to DIN EN ISO 9227. Under this test, the corrosion resistance of S-BT studs with duplex-coating is significantly higher as compared to hot dip galvanized (HDG) systems with at least 40µm coating thickness.

Grade A4 stainless steel S-BT studs remain stable under this test and withstand corrosion due to passive surface.

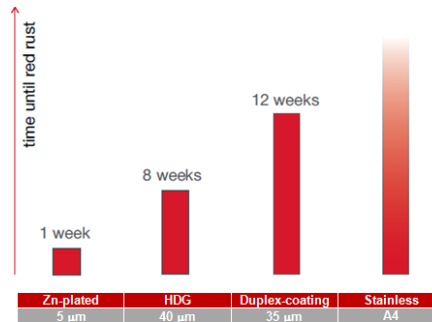

Cyclic corrosion test

The cyclic corrosion test gives a more realistic assessment of corrosion resistance under natural environments. Under this test, the corrosion resistance of S-BT studs with duplex-coating is comparable and even higher than HDG systems. Grade A4 stainless steel S-BT studs also remain stable under this cyclic corrosion test.

Test results

On the S-BT studs with aluminum sealing washer no corrosion was found after 12 weeks in the cyclic corrosion test. All aluminum sealing washers have adequately sealed the drilled holes over the test period of time. There was no visible corrosion in the bore holes.

Conclusions

- In the ISO 16701 test, the material combination of aluminum sealing washer and the duplex-coating of the carbon steel S-BT studs has been found to be optimal.
- After 12 weeks in the cyclic climate chamber the coating system of the carbon steel S-BT studs showed no tendencies to contact corrosion. The combination is suitable for use in C1, C2 and C3 environment acc. DIN EN ISO 9223:2012
- No corrosion was found in the drilled holes. This is strong evidence that the sealing washer provides an effective seal.

5.8.4 Stainless steel S-BT studs

General comments

The S-BT stainless studs are made from the duplex stainless steel type 1.4462. This grade of stainless steel is classified as corrosion resistance class IV according to DIN EN 1993-1-4:2015, which makes the material suitable for aggressive environments like in coastal and offshore applications.

The Hilti X-BT system was developed by Hilti Corporation especially for applications on steel structures that form part of oil and gas production facilities, in shipbuilding and in general steel construction. Therefore comprehensive corrosion tests (electrochemical tests, field test) have been performed on the X-BT stud. The stainless steel S-BT studs are intended to be used for the same applications and the studs are made of the same material as the shank of the X-BT fastener, duplex steel type 1.4462.

Outdoor applications



Outdoor, rural or urban environment with low pollution
Large distance (> 10 km) from the sea



Outdoor, rural or urban environment with moderate concentration of pollutants and/or salt from sea water
Distance from the sea 1-10 km



Coastal areas
Distance from the sea < 1 km



Outdoor, areas with heavy industrial pollution
Atmospheric SO₂ concentration > 10 µg/m³ as yearly average (e.g. close to polluting plants)



Close proximity to roadways treated with de-icing salts,
Distance from roadways < 10 m

Environmental conditions for usage of stainless steel S-BT studs.

Test concept

The corrosion behavior of the X-BT fastener was assessed by MPA Stuttgart in 2009. Based on these investigations, MPA Stuttgart assessed the corrosion behavior of the stainless steel S-BT fasteners.

The MPA report evaluates and assesses the S-BT stainless studs in terms of the following corrosion topics:

- Evaluation and assessment of atmospheric corrosion
 - Pitting or crevice corrosion
 - Stress corrosion cracking
 - Bimetallic corrosion
- Corrosion resistance of stainless steels on the basis of their composition
- Long-term exposure tests in maritime atmospheres
- Electrochemical tests

Test results

- On the basis of the investigations mentioned above, MPA Stuttgart assumed that the stainless S-BT studs have very good resistance to corrosion, even in atmospheres containing chlorides and are comparable to that of the X-BT.
- Tests at MPA Stuttgart confirmed high resistance to pitting or crevice corrosion.
- Tests carried out at the University of Leoben showed that the material also has good resistance to stress corrosion cracking even in highly aggressive media.

Conclusions

Hilti S-BT stainless fasteners made from stainless steel offer excellent corrosion resistance in atmospheres containing chloride ions, i.e. coastal areas and areas near roads treated with de-icing salts.

Based on the examinations from MPA Stuttgart, the estimated life time in typical atmospheres, from a corrosion-specific point of view, is at least 40 years.

5.9 Volume swelling of SN 12 sealing washer (stainless steel S-BT studs)

(Refer to section 3.1.1 material No. ③)

Chemicals	Volume swell				
	< 20%	20-40%	> 40-60%	> 60-80%	> 80-100%
1. Water at 80°C	■				
2. Sea water	■				
3. Zinc chloride 10%	■				
4. Sodium chloride 15%	■				
5. Hydrochloric acid 10%	■				
6. Acetic acid	■				
7. Acrylonitrile				■	
8. Aniline				■	
9. n-Butyl acetate					■
10. Diethylether		■			
11. Ethanol	■				
12. Glycerol	■				
13. n-Hexane	■				
14. Methanol	■				
15. Methyl ethyl ketone				■	
16. Nitrobenzene				■	
17. 1-Propanol	■				
18. Oil (ASTM-1) at 80°C	■				
19. Oil (ASTM-2) at 80°C		■			
20. Oil (ASTM-3) at 80°C		■			
21. Reference fuel B (isooctane/toluene, 70/30)				■	
22. Reference fuel C (isooctane/toluene, 50/50)					■
23. Hydraulic brake fluid	■				
24. Hydraulic brake fluid at 100°C		■			
25. Antifreeze (ethylene glycol/water 50/50) at 125°C		■			

Material: 3.1107 Elastomer: CR ozone and UV resistance Temperature range: -40°C to +100°C

Volume swelling is a reaction of the material of the washer when it's in contact with the different substances. It's used as a parameter to describe the chemical reaction.

The swelling factor gives an indication of the behavior of the material, but swelling does not lead directly to loss of the sealing property. With an installed stainless steel S-BT stud, the washer is compressed against the base steel. Without any specific requirement a general guideline is that the washer material is resistant to all substances where the volume swelling value is $\leq 40\%$.

The table above is valid only for stainless steel S-BT studs.

5.10 Material safety data sheet acc. to ISO/DIS 11014 for EPDM sealing ring of AN10 and SN12 sealing washer

5.10.1 Identification of substance

Product details

Trade name: Plate 2.0x650x50.000 mm OE 3.1107

Application of the substance / the preparation: Rubber compound

Manufacturer/supplier:

PHOENIX CBS GmbH, Hannoversche Straße 88, D-21079 Hamburg

Information department:

Conseo GmbH Abteilung Umweltschutz
Hannoversche Straße 88
D-21079 Hamburg, 0049(0)40 32809 2794

Emergency information:

0049(0)40 7667 2233

5.10.2 Composition/data on components

Chemical characterization

Description: Mixture of the substances listed below with non-hazardous additions

Dangerous components

117-81-7	bis(2-ethylhexyl) phthalate	T; R 60-61	2.5-10%
1309-48-4	magnesium oxide		2.5-10%
1314-13-2	zinc oxide		2.5-10%
68953-84-4	N,N'-Diaryl-p-phenyldiamine	Xi, N; R 43-50/53	≤ 1.0%
97-39-2	1,3-di-o-tolylguanidine	T; R 25	≤ 1.0%

5.10.3 Hazards identification

Hazard description U

Information pertaining to particular dangers for man and environment:

The product has been classified in accordance with EU directives / national laws respectively. In the version marketed, it presents no risk to the environment or to health. Following directive 67 / 54 8 EC, annex VI, point 9.3 it is not necessary to be labelled.

Classification system

The classification was made according to the latest editions of international substances lists and expanded upon from company and literature data.

NFPA ratings (scale 0 - 4)

Health = 0, Fire = 0, Reactivity = 0



HMIS-ratings (scale 0-4)

Health = 0, Fire = 0, Reactivity = 0

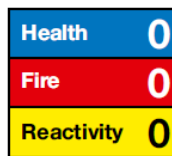

5.10.4 First aid measures

General information: No special measures required.

After inhalation: Supply fresh air; consult doctor in case of complaints.

After skin contact: Generally the product does not irritate the skin.

After eye contact: Rinse opened eye for several minutes under running water.

After swallowing: If symptoms persist consult doctor.

5.10.5 Fire fighting measures

Suitable extinguishing agents:

CO₂, extinguishing powder or water spray. Fight larger fires with water spray or alcohol resistant foam.

Special hazards caused by the material, its products of combustion or resulting gases:

Formation of toxic gases is possible during heating or in case of fire.

In case of fire, the following can be released:

Carbon monoxide (CO), Sulphur dioxide (SO₂), Hydrogen chloride (HCl)

Protective equipment: No special measures required.

5.10.6 Accidental release measures

Person-related safety precautions: Not required.

Measures for environmental protection: No special measures required.

Measures for cleaning/collecting: Pick up mechanically.

Additional information: No dangerous substances are released.

5.10.7 Handling and storage

Handling

Information for safe handling: No special measures required.

Information about protection against explosions and fires:

No special measures required.

Storage

Requirements to be met by storerooms and receptacles:

No special requirements.

Information about storage in one common storage facility: Not required.

Further information about storage conditions: None.

5.10.8 Exposure controls and personal protection

Additional information about design of technical systems:

No further data.

Components with limit values that require monitoring at the workplace:

When working with the product N-nitrosamines can be liberated

117-81-7 bis(2-ethylhexyl) phthalate

PEL	5 mg/m ³
REL	Short-term value: 10 mg/m ³ Long-term value: 5 mg/m ³
TLV	5 mg/m ³

1309-48-4 magnesium oxide

PEL	15* mg/m ³ fume
TLV	10 mg/m ³ fume

1314-13-2 zinc oxide

PEL	15*; 5** mg/m ³ Dust only *Total dust **Respirable dust
REL	Short-term value: C 15*; 10** mg/m ³ Long-term value: 5, 5** mg/m ³ Zinc oxide, Dust only; *15-min Dust only; **Zinc
TLV	Short-term value: 10** mg/m ³

Long-term value: 10* 5** mg/m³
 *dust **fume; *NIC-2 R; *10 R; *((e))

Additional information

The lists that were valid during formulation were used as a basis.

Personal protective equipment

General protective and hygienic measures:

The usual precautionary measures for handling chemicals should be followed.

Protection of hands

The glove material must be impermeable and resistant to the product / the substance / the preparation.

As no test information is available, no recommendation about glove material can be given for the product/ the preparation/ the chemical mixture.

Selection of the glove material on consideration of the penetration times, rates of diffusion and the degradation.

Glove material

Selection of suitable gloves does not only depend on the material, but also on further marks of quality and varies from manufacturer to manufacturer. As the product is a preparation of several substances, the resistance of the glove material can't be calculated in advance and must therefore be checked prior to the application.

Penetration time of glove material

The exact breakthrough time must be stated by the manufacturer of the protective gloves and must be observed.

Eye protection

Not required.

5.10.9 Physical and chemical properties**General Information**

Form:	Solid
Color:	According to product specification
Odor:	Characteristic
Change in condition	
Melting point/melting range:	Undetermined.
Boiling point/boiling range:	Undetermined.
Flash point:	Not applicable.
Ignition temperature:	370.0°C (698°F)
Auto igniting:	Product is not self-igniting.
Danger of explosion:	Product does not present an explosion hazard.
Density at 20°C (68°F):	1.380 g/cm ³
Solubility in / miscibility with water:	Insoluble.
Solvent content:	
Organic solvents:	0.0 %
Solids content:	94.5 %

5.10.10 Stability and reactivity**Thermal decomposition / conditions to be avoided**

No decomposition if used according to specifications.

Dangerous reactions

No dangerous reactions known.

Dangerous products of decomposition

Hydrogen chloride (HCl)

Toxic pyrolysis products.

5.10.11 Toxicological information**Acute toxicity****LD/LC50 values that are relevant for classification**

117-81-7 bis(2-ethylhexyl) phthalate

Oral	LD50	30600 mg/kg (rat)
Dermal	LD50	25000 mg/kg (rbt)

Primary irritant effect**On the skin:** No irritant effect.**On the eye:** No irritating effect.**Sensitization:** No sensitizing effects known.**Additional toxicological information**

The product is not subject to classification according to internally approved calculation methods for preparations. When used and handled according to specifications, the product does not have any harmful effects according to our experience and the information provided to us.

5.10.12 Ecological information**General notes**

Generally not hazardous to water

5.10.13 Disposal considerations**Product****Recommendation**

Smaller quantities can be disposed of with household waste.

Can be disposed of under observance of the technical instructions after consultation with the local authorities and waste disposers.

Uncleaned packagings**Recommendation:** Disposal must be according to official regulations.**5.10.14 Transport information****DOT regulations:****Hazard class:** -**Land transport ADR/RID (cross-border):****ADR/RID class:** -**Maritime transport IMDG:****IMDG Class:** -**Marine pollutant:** No**Air transport ICAO-TI and IATA-DGR:****ICAO/IATA Class:** -**Transport/additional information:**

Not hazardous according to the above specifications.

5.10.15 Regulations**Sara****Section 355 (extremely hazardous substances):**

None of the constituents are listed.

Section 313 (Specific toxic chemical listings):

117-81-7 bis(2-ethylhexyl) phthalate

TSCA (Toxic Substances Control Act):

9010-98-4 Polychloropren CR

117-81-7 bis(2-ethylhexyl) phthalate

1309-48-4 magnesium oxide

1314-13-2 zinc oxide

97-39-2 1,3-di-o-tolylguanidine

101-67-7 bis(4-octylphenyl)amine

97-74-5 tetramethylthiuram monosulphide

Proposition 65**Chemicals known to cause cancer:**

117-81-7	bis(2-ethylhexyl) phthalate
Chemicals known to cause reproductive toxicity:	
None of the constituents are listed.	
Carcinogen categories	
EPA (Environmental Protection Agency)	
117-81-7	bis(2-ethylhexyl) phthalate B2
1314-13-2	zinc oxide D
IARC (International Agency for Research on Cancer)	
117-81-7	bis(2-ethylhexyl) phthalate 2B
NTP (National Toxicology Program)	
117-81-7	bis(2-ethylhexyl) phthalate R
TLV (Threshold Limit Value established by ACGIH)	
117-81-7	bis(2-ethylhexyl) phthalate A3
MAK (German Maximum Workplace Concentration)	
None of constituents are listed.	
NIOSH-Ca (National Institute for Occupational Safety and Health)	
117-81-7	bis(2-ethylhexyl) phthalate
OSHA-Ca (Occupational Safety & Health Administration)	
None of the constituents are listed.	

Product-related hazard information

Observe the general safety regulations when handling chemicals.
 The product has been classified in accordance with EU directives / national laws respectively.
 In the version marketed, it presents no risk to the environment or to health.
 Following directive 67 / 548 EC, annex VI, point 9.3 it is not necessary to be labelled.

Hazard symbols

U

National regulations

Technical instructions (air)

Class	Share in %
I	0.4
NK	5.5

Water hazard class: Generally not hazardous to water.

Other regulations, limitations and prohibitive regulations

Subject to the regulations for N-Nitrosamines.

5.10.16 Other information

This information is based on our present knowledge. However, this shall not constitute a guarantee for any specific product features and shall not establish a legally valid contractual relationship.

Department issuing MSDS: Conseo GmbH Abteilung Umweltschutz

Contact: Hr. Dr. Kräßig / Hr. Dr. Laugwitz

6 Fastener program

Designation	Item no.	Product name	Comment	Application
S-BT-GF M8/7 AN 6	2140527	Threaded stud		Grating
S-BT-MF M8/7 AN 6	2139174	Threaded stud	with serrated flange nut	Multipurpose
S-BT-MF M8/15 AN 6	2148618	Threaded stud	with serrated flange nut	Multipurpose
S-BT-MF M10/15 AN 6	2140528	Threaded stud	with serrated flange nut	Multipurpose
S-BT-MF W10/15 AN 6	2139173	Threaded stud	with serrated flange nut	Multipurpose
S-BT-GR M8/7 SN 5	2149240	Threaded stud		Grating
S-BT-GR M8/7 SN 6	2140529	Threaded stud		Grating
S-BT-GR M8/7 SN 6 AL	2140742	Threaded stud		Grating
S-BT-MR M8/7 SN 5	2139171	Threaded stud	with serrated flange nut	Multipurpose
S-BT-MR M8/7 SN 6	2139172	Threaded stud	with serrated flange nut	Multipurpose
S-BT-MR M8/7 SN 6 AL	2140743	Threaded stud	with serrated flange nut	Multipurpose
S-BT-MR M8/15 SN 5	2148622	Threaded stud	with serrated flange nut	Multipurpose
S-BT-MR M8/15 SN 6	2148612	Threaded stud	with serrated flange nut	Multipurpose
S-BT-MR M8/15 SN 6 AL	2148614	Threaded stud	with serrated flange nut	Multipurpose
S-BT-MR M10/15 SN 5	2148623	Threaded stud	with serrated flange nut	Multipurpose
S-BT-MR M10/15 SN 6	2140740	Threaded stud	with serrated flange nut	Multipurpose
S-BT-MR M10/15 SN 6 AL	2140744	Threaded stud	with serrated flange nut	Multipurpose
S-BT-MR W10/15 SN 5	2148624	Threaded stud	with serrated flange nut	Multipurpose
S-BT-MR W10/15 SN 6	2140741	Threaded stud	with serrated flange nut	Multipurpose
S-BT-MR W10/15 SN 6 AL	2140745	Threaded stud	with serrated flange nut	Multipurpose
TS-BT 5.5-74 S	2143137	Stepped drill bit	steel	
TS-BT 5.5-74 AL	2143138	Stepped drill bit	aluminum	
TS-BT 4.3-74 S	2143139	Stepped drill bit	steel	
S-DG BT M8/7 Short 6	2143260	Depth gauge		
S-DG BT M10-W10/15 Long 6	2143261	Depth gauge		
S-DG BT M8/15 Long 6	2148575	Depth gauge		
S-DG BT M8/7 Short 5	2149241	Depth gauge		
S-DG BT M10-W10/15 Long 5	2149242	Depth gauge		
S-DG BT M8/15 Long 5	2149243	Depth gauge		
S-CC BT 6	2143270	Calibration card		
S-CC BT 5	on hold	Calibration card		
S-BT 1/4" – 5 Nm	2143271	Torque tool	manual torque tool (5 Nm)	
X-BT 1/4" – 8 Nm	2119272	Torque tool	manual torque tool (8 Nm)	
S-NS 13 C 95/3 3/4"	2149244	Nut setter	for nut M8	
S-NS 15 C 95/3 3/4"	2149245	Nut setter	for nut M10	
S-NS 9/16" C 95/3 3/4"	2149246	Nut setter	for nut W10	

7 Approvals

7.1 Bureau Veritas



Marine & Offshore
Division

Certificate number: 45116/A0 BV

File number: ACM 139/1905/2

Product code: 0226H

This certificate is not valid when presented without the full attached schedule composed of 7 sections

www.veristar.com

TYPE APPROVAL CERTIFICATE

This certificate is issued to
Hilti Aktiengesellschaft
SCHAAN - LIECHTENSTEIN

for the type of product
MECHANICAL FASTENING SYSTEM
HILTI S-BT MECHANICAL FASTENING SYSTEM

- Requirements:**
BUREAU VERITAS Rules for the Classification of Steel Ships
BUREAU VERITAS Rules for the Classification of Offshore Units
BUREAU VERITAS Rules for the Classification of Naval Ships
BUREAU VERITAS Rules for the Classification of Yachts

This certificate is issued to attest that BUREAU VERITAS did undertake the relevant approval procedures for the product identified above which was found to comply with the relevant requirements mentioned above.

This certificate will expire on: 20 Apr 2021

For BUREAU VERITAS,
At BV HAMBURG, on 20 Apr 2016,
Udo Storm



This certificate remains valid until the date stated above, unless cancelled or revoked, provided the conditions indicated in the subsequent page(s) are complied with and the product remains satisfactory in service. This certificate will not be valid if the applicant makes any changes or modifications to the approved product, which have not been notified to, and agreed in writing with BUREAU VERITAS. Should the specified regulations or standards be amended during the validity of this certificate, the product(s) is/are to be re-approved prior to it/they being placed on board vessels to which the amended regulations or standards apply. This certificate is issued within the scope of the General Conditions of BUREAU VERITAS Marine & Offshore Division available on the internet site www.veristar.com. Any Person not a party to the contract pursuant to which this document is delivered may not assert a claim against BUREAU VERITAS for any liability arising out of errors or omissions which may be contained in said document, or for errors of judgement, fault or negligence committed by personnel of the Society or of its Agents in establishment or issuance of this document, and in connection with any activities for which it may provide.

The electronic version is available at: <http://www.veristamb.com/veristamb/jsp/viewPublicPdfType.jsp?id=z050ffikdi>
BV Mod. Ad.E 530 October 2014 This certificate consists of 4 page(s)

THE SCHEDULE OF APPROVAL

1. PRODUCT DESCRIPTION :

The Hilti S-BT fasteners are threaded studs manufactured from hardened carbon steel 1038 and austenitic-ferritic (Duplex) stainless steel 1.4462. The S-BT threaded studs are fasteners with male threads (metric M8 and M10 or inch W10) for attachment on one end and a threaded tip on the other end for embedment into the structural steel or aluminium. Carbon steel studs are supplied with an aluminium sealing washer Ø 10 mm, stainless steel studs are supplied with a stainless steel sealing washer Ø 12 mm, both with an EPDM sealing ring. Fastenings are made by screwing in the S-BT stud in a predrilled pilot hole (without penetration of the base material) or a drill through hole. The Hilti S-BT mechanical fastening system comprises the Hilti drilling tool, Hilti step drill bit, setting tool, depth gauge, screw-in stainless steel and carbon steel threaded studs S-BT and accessories.

Identification of Components:

Component Name	Designation
S-BT-MR M10/15 SN 6	Stainless steel threaded stud M10 with sealing washer
S-BT-MR M10/15 SN 6 AL	Stainless steel threaded stud M10 with sealing washer
S-BT-MR W10/15 SN 6	Stainless steel threaded stud W10 with sealing washer
S-BT-MR W10/15 SN 6 AL	Stainless steel threaded stud W10 with sealing washer
S-BT-MF M10/15 AN 6	Carbon steel threaded stud M10 with sealing washer
S-BT-MF W10/15 AN 6	Carbon steel threaded stud W10 with sealing washer
S-BT-MR M10/15 SN 5	Stainless steel threaded stud M10 with sealing washer
S-BT-MR W10/15 SN 5	Stainless steel threaded stud W10 with sealing washer
S-BT-MR M8/15 SN 6	Stainless steel threaded stud M8 with sealing washer
S-BT-MR M8/15 SN 6 AL	Stainless steel threaded stud M8 with sealing washer
S-BT-MR M8/7 SN 6	Stainless steel threaded stud M8 with sealing washer
S-BT-MR M8/7 SN 6 AL	Stainless steel threaded stud M8 with sealing washer
S-BT-MR M8/7 SN 5	Stainless steel threaded stud M8 with sealing washer
S-BT-MR M8/7 SN 5 AL	Stainless steel threaded stud M8 with sealing washer
S-BT-MF M8/15 AN 6	Carbon steel threaded stud M8 with sealing washer
S-BT-MF M8/7 AN 6	Carbon steel threaded stud M8 with sealing washer
S-BT-MF M8/7 AN 6 AL	Carbon steel threaded stud M8 with sealing washer
S-BT-MR M8/15 SN 5	Stainless steel threaded stud M8 with sealing washer
S-BT-MR M8/7 SN 5	Stainless steel threaded stud M8 with sealing washer
S-BT-MR M8/7 SN 5 AL	Stainless steel threaded stud M8 with sealing washer
X-FCM	Grating fastener, carbon steel, zinc plated
X-FCM-M	Grating fastener, carbon steel, duplex coated
X-FCM-R	Grating fastener, stainless steel

2. DOCUMENTS AND DRAWINGS :

Designation	Revision / Date
Hilti S-BT Technical Data Sheet	04/2016

3. TEST REPORTS :

According to the following tests:

- Test Report No. 279/15 at HTL Rankweil, Bautechnische Versuchsanstalt /AUSTRIA on February 12th, 2016
- Report No. TM-414/14_2 at Hilti AG / Liechtenstein on 01.07.2015
- Investigation Report 903 0160 000/Bf at MPA University of Stuttgart / GERMANY on 14.09.2015

4. APPLICATION / LIMITATION :

- 4.1 The mechanical fastening system is intended for fastening applications in shipbuilding and offshore structures as far as the BUREAU VERITAS Rules are complied with:
- Metal and fiberglass grating
 - Cable, conduit and tubing connectors
 - Trays, channels and struts for cable, conduit and tubing runs
 - Instrumentation, Junction Boxes, Lighting
 - Pipe hangers
 - Signage
 - Door frames
 - Mounting cabinets, securing furniture, utensils, etc.
- 4.2 The thickness of the base material is $3 \text{ mm} \leq t < 6 \text{ mm}$ for drill through holes and $t \geq 5 \text{ mm}$ for fasteners intended to be set in predrilled pilot holes.
- 4.3 The thickness of the fastened material is for the S-BT M8 studs $\leq 7 \text{ mm}$ and for the S-BT M10 / S-BT W10 $\leq 15 \text{ mm}$. The minimum thickness of the fastened material is 1.6 mm.
- 4.4 The minimum distance to the edge of a flange or cutout is not to be less than 6 mm and the minimum spacing between fasteners is not to be less than 15 mm.
- 4.5 The minimum tensile strength of the steel base material is not to be less than 340 N/mm^2 and not to be less than 270 N/mm^2 for aluminium base material. The maximum tensile strength of the steel base material is not to be more than 630 N/mm^2 .
- 4.6 No limits with regards to the thickness of the base material.
- 4.7 The S-BT fastening system may be used in areas where drilling into the base material is permissible.
- 4.8 The maximum tightening torque of grating disc or nut fitted to the threaded fastener is not to be more than 5 Nm (steel base material thickness $3 \text{ mm} \leq t < 6 \text{ mm}$ and aluminium) and not to be more than 8 Nm for steel base material thickness $t \geq 6 \text{ mm}$.
- 4.9 The fasteners are not to be used on structural members requiring fatigue verification.
- 4.10 The manufacturer's assembly instructions and recommendations are to be complied with.

5. PRODUCTION SURVEY REQUIREMENTS :

- 5.1 The mechanical fastening systems are to be supplied by the manufacturer in compliance with the type described in this certificate.
- 5.2 This type of product is within the category HBV of BUREAU VERITAS Rule Note NR320.
- 5.3 Hilti Aktiengesellschaft has to make the necessary arrangements to have its works recognised by BUREAU VERITAS in compliance with the requirements of NR320 for HBV products :

Hilti Plant 1
 Feldkircherstrasse 100
 PO Box 333
 FL-9494 Schaan
 Liechtenstein
 and
 Precistec s.r.o.
 Pod Stadionem 7
 74221 Koprivnice
 Czech Republic

The accessory, the grating fastener X-FCM, X-FCM-M and X-FCM-R, are manufactured at the following production site:
 WP-Wörgartner Produktions GmbH
 Bahnhofstraße 21
 A-6372 Oberndorf
 Austria

6. MARKING OF PRODUCT :

The mechanical fastening system should be clearly identified with:

- Manufacturer's name or logo
- Type designation

7. OTHERS :

- 7.1 The mechanical fastening systems will be delivered with the relevant documentation / user's guide.

- 7.2 This approval is given on the understanding that the Society reserves the right to require check tests to be carried out on the units at any time and that Hilti Aktiengesellschaft, Schaan – Liechtenstein will accept full responsibility for informing shipbuilders, ship owners or their subcontractors of the proper methods of use and general maintenance of the units and the conditions of this approval.

*** END OF CERTIFICATE ***