

European Technical Approval ETA-11/0374

English translation prepared by DIBt - Original version in German language

Handelsbezeichnung <i>Trade name</i>	Hilti Bolzenanker HSA <i>Hilti stud anchor HSA</i>
Zulassungsinhaber <i>Holder of approval</i>	Hilti Aktiengesellschaft Business Unit Anchors 9494 Schaan FÜRSTENTUM LIECHTENSTEIN
Zulassungsgegenstand und Verwendungszweck <i>Generic type and use of construction product</i>	Kraftkontrolliert spreizender Dübel in den Größen M6, M8, M10, M12, M16 und M20 zur Verankerung in ungerissenem Beton <i>Torque controlled expansion anchor of sizes M6, M8, M10, M12, M16 and M20 for use in non-cracked concrete</i>
Geltungsdauer: <i>Validity:</i>	vom <i>from</i> 19 July 2012 bis <i>to</i> 19 July 2017
Herstellwerk <i>Manufacturing plant</i>	Hilti Werke

Diese Zulassung umfasst
This Approval contains

19 Seiten einschließlich 12 Anhänge
19 pages including 12 annexes

I LEGAL BASES AND GENERAL CONDITIONS

- 1 This European technical approval is issued by Deutsches Institut für Bautechnik in accordance with:
 - Council Directive 89/106/EEC of 21 December 1988 on the approximation of laws, regulations and administrative provisions of Member States relating to construction products¹, modified by Council Directive 93/68/EEC² and Regulation (EC) N° 1882/2003 of the European Parliament and of the Council³;
 - Gesetz über das In-Verkehr-Bringen von und den freien Warenverkehr mit Bauprodukten zur Umsetzung der Richtlinie 89/106/EWG des Rates vom 21. Dezember 1988 zur Angleichung der Rechts- und Verwaltungsvorschriften der Mitgliedstaaten über Bauprodukte und anderer Rechtsakte der Europäischen Gemeinschaften (Bauproduktengesetz - BauPG) vom 28. April 1998⁴, as amended by law of 31 October 2006⁵;
 - Common Procedural Rules for Requesting, Preparing and the Granting of European technical approvals set out in the Annex to Commission Decision 94/23/EC⁶;
 - Guideline for European technical approval of "Metal anchors for use in concrete - Part 2: Torque controlled expansion anchors ", ETAG 001-02.
- 2 Deutsches Institut für Bautechnik is authorized to check whether the provisions of this European technical approval are met. Checking may take place in the manufacturing plant. Nevertheless, the responsibility for the conformity of the products to the European technical approval and for their fitness for the intended use remains with the holder of the European technical approval.
- 3 This European technical approval is not to be transferred to manufacturers or agents of manufacturers other than those indicated on page 1, or manufacturing plants other than those indicated on page 1 of this European technical approval.
- 4 This European technical approval may be withdrawn by Deutsches Institut für Bautechnik, in particular pursuant to information by the Commission according to Article 5(1) of Council Directive 89/106/EEC.
- 5 Reproduction of this European technical approval including transmission by electronic means shall be in full. However, partial reproduction can be made with the written consent of Deutsches Institut für Bautechnik. In this case partial reproduction has to be designated as such. Texts and drawings of advertising brochures shall not contradict or misuse the European technical approval.
- 6 The European technical approval is issued by the approval body in its official language. This version corresponds fully to the version circulated within EOTA. Translations into other languages have to be designated as such.

¹ Official Journal of the European Communities L 40, 11 February 1989, p. 12
² Official Journal of the European Communities L 220, 30 August 1993, p. 1
³ Official Journal of the European Union L 284, 31 October 2003, p. 25
⁴ *Bundesgesetzblatt Teil I 1998*, p. 812
⁵ *Bundesgesetzblatt Teil I 2006*, p. 2407, 2416
⁶ Official Journal of the European Communities L 17, 20 January 1994, p. 34

II SPECIFIC CONDITIONS OF THE EUROPEAN TECHNICAL APPROVAL

1 Definition of product/ products and intended use

1.1 Definition of the construction product

The Hilti stud anchor HSA in the range of M6, M8, M10, M12, M16 and M20 is an anchor made of galvanised or stainless steel which is placed into a drilled hole and anchored by torque-controlled expansion.

An illustration of the product and intended use is given in Annex 1.

1.2 Intended use

The anchor is intended to be used for anchorages for which requirements for mechanical resistance and stability and safety in use in the sense of the Essential Requirements 1 and 4 of Council Directive 89/106 EEC shall be fulfilled and failure of anchorages made with these products would cause risk to human life and/or lead to considerable economic consequences. The anchor is to be used only for anchorages subject to static or quasi-static loading in reinforced or unreinforced normal weight concrete of strength classes C20/25 at minimum and C50/60 at most according to EN 206:2000-12.

The anchor may be anchored in non-cracked concrete only.

Hilti Stud Anchor HSA made of galvanized carbon steel HSA / HSA-BW or stainless steel grade A2 HSA-R2:

The anchor made of galvanized carbon steel or stainless steel grade A2 may only be used in structures subject to dry internal conditions.

Hilti Stud Anchor HSA-R made of stainless steel grade A4 HSA-R:

The anchor made of stainless steel grade A4 may be used in structures subject to dry internal conditions and also in structures subject to external atmospheric exposure (including industrial and marine environment), or exposure in permanently damp internal conditions, if no particular aggressive conditions exist. Such particular aggressive conditions are e.g. permanent, alternating immersion in seawater or the splash zone of seawater, chloride atmosphere of indoor swimming pools or atmosphere with extreme chemical pollution (e.g. in desulphurization plants or road tunnels where de-icing materials are used).

The provisions made in this European technical approval are based on an assumed working life of the anchor of 50 years. The indications given on the working life cannot be interpreted as a guarantee given by the producer, but are to be regarded only as a means for choosing the right products in relation to the expected economically reasonable working life of the works.

2 Characteristics of the product and methods of verification

2.1 Characteristics of the product

The anchor corresponds to the drawings and provisions given in Annexes 2, 3 and 4. The characteristic material values, dimensions and tolerances of the anchor not given in Annexes 2, 3 and 4 shall correspond to the respective values laid down in the technical documentation⁷ of this European technical approval.

The characteristic values for the design of the anchorages in accordance with the "Guideline for European technical approval of Metal Anchors for use in concrete", Annex C, Method A are given in Annex 8 and 9.

The characteristic values for the design of the anchorages in accordance with the design method A of CEN/TS 1992-4-4 are given in Annex 10 and 11.

Each anchor is marked with the identifying mark of the producer, the anchor identity, the size of thread and the maximum thickness of fixture for each anchorage depth according to Annex 1. In addition, the minimum and standard anchorage depth is indicated on the bolt. Each anchor made of stainless steel is marked according to Annex 3, Table 2.

For the minimum and the medium embedment depth, there are additional marks on the bolt according Annex 1.

The anchor shall only be packaged and supplied as a complete unit.

2.2 Methods of verification

The assessment of fitness of the anchor for the intended use in relation to the requirements for mechanical resistance and stability and safety in use in the sense of the Essential Requirements 1 and 4 has been made in accordance with the "Guideline for European technical approval of Metal Anchors for Use in Concrete", Part 1 "Anchors in general" and Part 2 "Torque-controlled expansion anchors", on the basis of Option 7.

In addition to the specific clauses relating to dangerous substances contained in this European technical approval, there may be other requirements applicable to the products falling within its scope (e.g. transposed European legislation and national laws, regulations and administrative provisions). In order to meet the provisions of the Construction Products Directive, these requirements need also to be complied with, when and where they apply.

3 Evaluation and attestation of conformity and CE marking

3.1 System of attestation of conformity

According to the Decision 96/582/EG of the European Commission⁸ system 2(i) (referred to as system 1) of the attestation of conformity applies.

This system of attestation of conformity is defined as follows:

System 1: Certification of the conformity of the product by an approved certification body on the basis of:

- (a) Tasks for the manufacturer:
 - (1) factory production control;

⁷ The technical documentation of this European technical approval is deposited at the Deutsches Institut für Bautechnik and, as far as relevant for the tasks of the approved bodies involved in the attestation of conformity procedure, is handed over to the approved bodies.

⁸ Official Journal of the European Communities L 254 of 08.10.1996

- (2) further testing of samples taken at the factory by the manufacturer in accordance with a prescribed control plan;
- (b) Tasks for the approved body:
 - (3) initial type-testing of the product;
 - (4) initial inspection of factory and of factory production control;
 - (5) continuous surveillance, assessment and approval of factory production control.

Note: Approved bodies are also referred to as "notified bodies".

3.2 Responsibilities

3.2.1 Tasks for the manufacturer

3.2.1.1 Factory production control

The manufacturer shall exercise permanent internal control of production. All the elements, requirements and provisions adopted by the manufacturer shall be documented in a systematic manner in the form of written policies and procedures, including records of results performed. This production control system shall insure that the product is in conformity with this European technical approval.

The manufacturer may only use initial / raw / constituent materials stated in the technical documentation of this European technical approval.

The factory production control shall be in accordance with the control plan which is part of the technical documentation of this European technical approval. The control plan is laid down in the context of the factory production control system operated by the manufacturer and deposited with Deutsches Institut für Bautechnik.⁹

The results of factory production control shall be recorded and evaluated in accordance with the provisions of the control plan.

3.2.1.2 Other tasks of manufacturer

The manufacturer shall, on the basis of a contract, involve a body which is approved for the tasks referred to in section 3.1 in the field of in order to undertake the actions laid down in section 3.2.2 For this purpose, the control plan referred to in sections 3.2.1.1 and 3.2.2 shall be handed over by the manufacturer to the approved body involved.

The manufacturer shall make a declaration of conformity, stating that the construction product is in conformity with the provisions of this European technical approval.

3.2.2 Tasks for the approved bodies

The approved body shall perform the

- initial type-testing of the product,
- initial inspection of factory and of factory production control,
- continuous surveillance, assessment and approval of factory production control,

in accordance with the provisions laid down in the control plan.

The approved body shall retain the essential points of its actions referred to above and state the results obtained and conclusions drawn in a written report.

The approved certification body involved by the manufacturer shall issue an EC certificate of conformity of the product stating the conformity with the provisions of this European technical approval.

⁹ The control plan is a confidential part of the European technical approval and only handed over to the approved body involved in the procedure of attestation of conformity. See section 3.2.2.

In cases where the provisions of the European technical approval and its control plan are no longer fulfilled the certification body shall withdraw the certificate of conformity and inform Deutsches Institut für Bautechnik without delay.

3.3 CE marking

The CE marking shall be affixed on each packaging of the anchor. The letters "CE" shall be followed by the identification number of the approved certification body, where relevant, and be accompanied by the following additional information:

- the name and address of the Producer (legal entity responsible for the manufacturer),
- the last two digits of the year in which the CE marking was affixed,
- the number of the EC certificate of conformity for the product,
- the number of the European technical approval,
- the number of the guideline for European technical approval,
- use category (ETAG 001-1 Option 7),
- size.

4 Assumptions under which the fitness of the product for the intended use was favourably assessed

4.1 Manufacturing

The European technical approval is issued for the product on the basis of agreed data/information, deposited with the Deutsches Institut für Bautechnik, which identifies the product that has been assessed and judged. Changes to the product or production process, which could result in this deposited data/information being incorrect, should be notified to the Deutsches Institut für Bautechnik before the changes are introduced. Deutsches Institut für Bautechnik will decide whether or not such changes affect the approval and consequently the validity of the CE marking on the basis of the approval and if so whether further assessment or alterations to the approval shall be necessary.

4.2 Design of anchorages

The fitness of the anchor for the intended use is given under the following conditions:

The anchorages are designed either in accordance with the

- "Guideline for European technical approval of Metal Anchors for use in concrete", Annex C, method A

or in accordance with the

- CEN/TS 1992-4-4 "Design of fastenings for use in concrete", Part 4-4: "Post-installed fasteners – Mechanical systems", design method A,

under the responsibility of an engineer experienced in anchorages and concrete work. A mixture of the design methods is not allowed.

Verifiable calculation notes and drawings are taking account of the loads to be anchored.

The position of the anchor is indicated on the design drawings (e.g. position of the anchor relative to reinforcement or to supports).

4.3 Installation of anchors

The fitness for use of the anchor can only be assumed if the anchor is installed as follows:

- Anchor installation carried out by appropriately qualified personnel and under the supervision of the person responsible for technical matters of the site,
- Use of the anchor only as supplied by the manufacturer without exchanging the components of an anchor,
- Anchor installation in accordance with the manufacturer's specifications and drawings and using the appropriate tools,
- Checks before placing the anchor to ensure that the strength class of the concrete in which the anchor is to be placed is in the range given and is not lower than that of the concrete to which the characteristic loads apply,
- Check of concrete being well compacted, e.g. without significant voids,
- Edge distances and spacing not less than the specified values without minus tolerances,
- Positioning of the drill holes without damaging the reinforcement,
- Drilling by hammer-drilling or diamond coring,
- In case of aborted hole: new drilling at a minimum distance away of twice the depth of the aborted hole or smaller distance if the aborted drill hole is filled with high strength mortar and if under shear or oblique tension load it is not in the direction of load application,
- Cleaning of the hole of drilling dust and water,
- Anchor installation such that the effective anchorage depth is complied with. This compliance is ensured, if the thickness of fixture is not greater than the maximum thickness of fixture marked on the anchor in accordance with Annex 2 and the hexagon nut is flush-mounted at the end of the thread of the bolt,
- Application of the torque moment given in Annex 5 using a calibrated torque wrench or tightening the anchor according to the impact screw driver, setting tool and the required setting time given in Annex 7.

5 Responsibility of the manufacturer

The manufacturer is responsible to ensure that the information on the specific conditions according to 1 and 2 including Annexes referred to as well as sections 4.2 and 4.3 is given to those who are concerned. This information may be made by reproduction of the respective parts of the European technical approval. In addition all installation data shall be shown clearly on the package and/or on an enclosed instruction sheet, preferably using illustration(s).

The minimum data required are:

- Diameter of drill bit,
- Thread diameter,
- Maximum thickness of the fixture,
- Minimum effective anchorage depth,
- Minimum hole depth,
- Torque moment,
- Information on the installation procedure, including cleaning of the hole, preferably by means of an illustration,
- Reference to any special installation equipment needed,
- Identification of the manufacturing batch.

All data shall be presented in a clear and explicit form.

Georg Feistel
Head of Department

beglaubigt:
Bürger

Hilti stud anchor HSA

HSA
HSA-R2
HSA-R

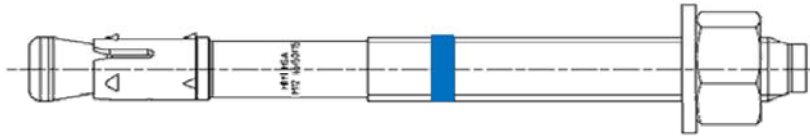

HSA-BW

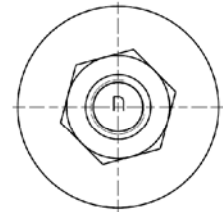
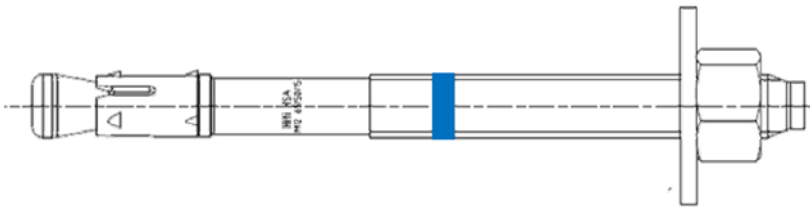

Product marking and identification of anchor

Beginning of thread: indicator for setting position ①

$h_{nom,1}$ is reached when the non-threaded part of the bolt is completely below the concrete surface.

Blue ring: indicator for setting position ②

$h_{nom,2}$ is reached when the blue ring is completely below the concrete surface.

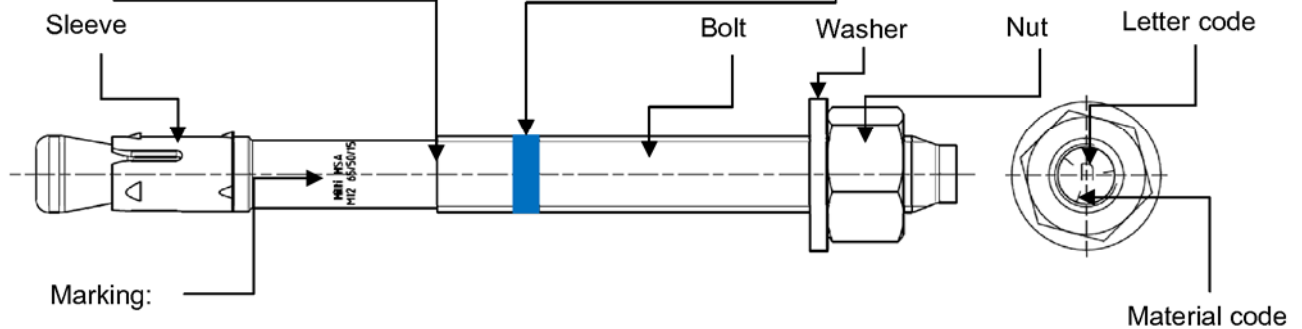

e.g.
Hilti HSA ... Brand and Anchor type
M12 65/50/15 ... Anchor size and the max. fixture thicknesses $t_{fix,1}/t_{fix,2}/t_{fix,3}$ for the corresponding min. anchorage depths $h_{nom,1}/h_{nom,2}/h_{nom,3}$

Setting position	①	②	③
max. t_{fix} [mm]	65	50	15
min. h_{nom} [mm]	64	79	114

Hilti Stud Anchor HSA

Annex 1

Product, Product marking and identification of anchor

Illustration of the anchor in use

a) One anchor length for different fixture thickness t_{fix} and the corresponding setting positions

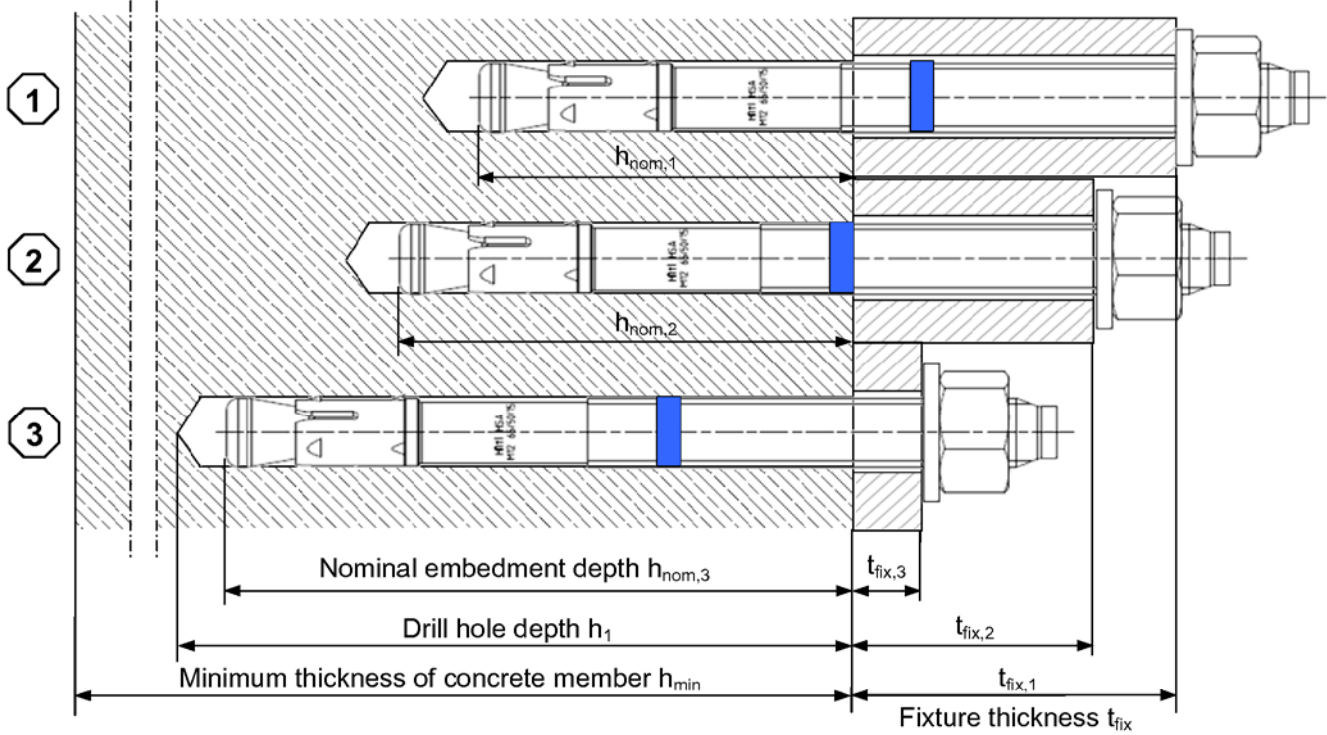

b) Different anchor length for different setting positions and the corresponding fixture thickness t_{fix}

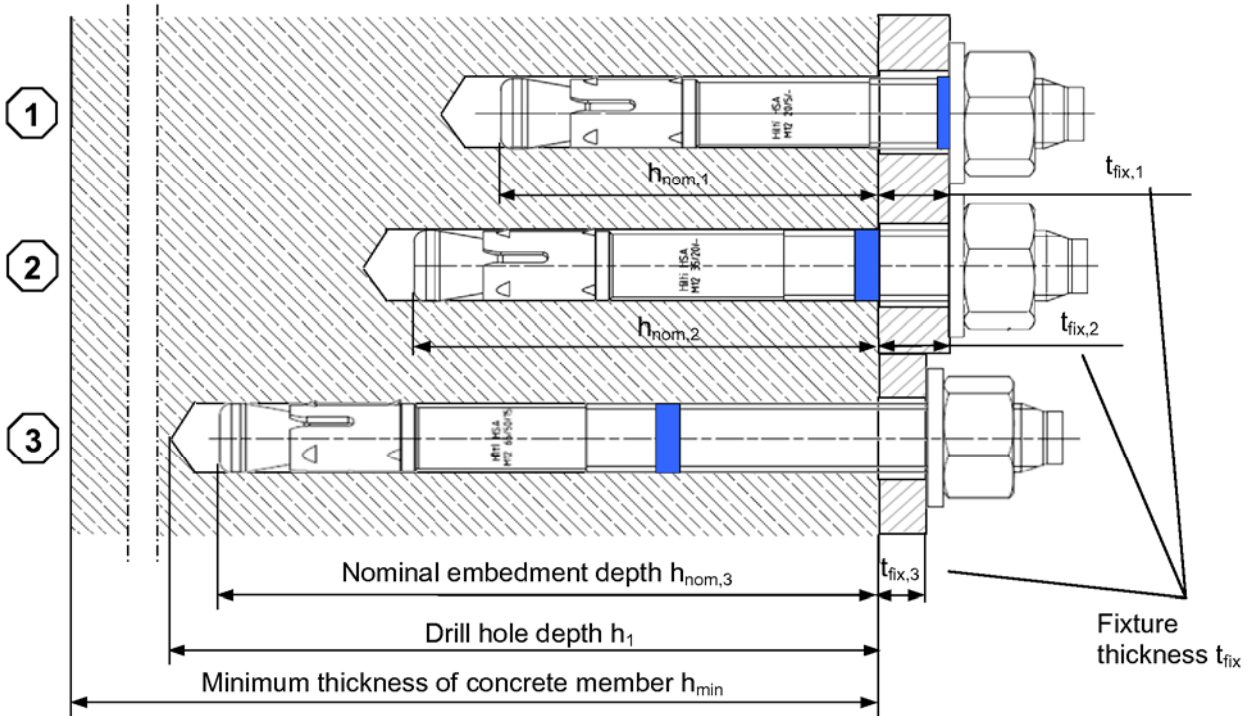

Hilti Stud Anchor HSA

Annex 2



Intended use

Table 1: Letter code of maximum fixture thickness for identification of anchor for available standard and special items¹⁾

Type Size Letter	HSA, HSA-BW, HSA-R2, HSA-R					
	M6 $t_{fix,1}/t_{fix,2}/t_{fix,3}$	M8 $t_{fix,1}/t_{fix,2}/t_{fix,3}$	M10 $t_{fix,1}/t_{fix,2}/t_{fix,3}$	M12 $t_{fix,1}/t_{fix,2}/t_{fix,3}$	M16 $t_{fix,1}/t_{fix,2}/t_{fix,3}$	M20 $t_{fix,1}/t_{fix,2}/t_{fix,3}$
z	5/-/-	5/-/-	5/-/-	5/-/-	5/-/-	5/-/-
y	10/-/-	10/-/-	10/-/-	10/-/-	10/-/-	10/-/-
x	15/5/-	15/5/-	15/5/-	15/-/-	15/-/-	15/-/-
w	20/10/-	20/10/-	20/10/-	20/5/-	20/5/-	20/-/-
v	25/15/-	25/15/-	25/15	25/10/-	25/10/-	25/-/-
u	30/20/-	30/20/-	30/20/-	30/15/-	30/15/-	30/5/-
t	35/25/5	35/25/-	35/25/-	35/20/-	35/20/-	35/10/-
s	40/30/10	40/30/-	40/30/-	40/25/-	40/25/-	40/15/-
r	45/35/15	45/35/5	45/35/5	45/30/-	45/30/-	45/20/5
q	50/40/20	50/40/10	50/40/10	50/35/-	50/35/-	50/25/10
p	55/45/25	55/45/15	55/45/15	55/40/5	55/40/-	55/30/15
o	60/50/30	60/50/20	60/50/20	60/45/10	60/45/5	60/35/20
n	65/55/35	65/55/25	65/55/25	65/50/15	65/50/10	65/40/25
m	70/60/40	70/60/30	70/60/30	70/55/20	70/55/15	70/45/30
l	75/65/45	75/65/35	75/65/35	75/60/25	75/60/20	75/50/35
k	80/70/50	80/70/40	80/70/40	80/65/30	80/65/25	80/55/40
j	85/75/55	85/75/45	85/75/45	85/70/35	85/70/30	85/60/45
i	90/80/60	90/80/50	90/80/50	90/75/40	90/75/35	90/65/50
h	95/85/65	95/85/55	95/85/55	95/80/45	95/80/40	95/70/55
g	100/90/70	100/90/60	100/90/60	100/85/50	100/85/45	100/75/60
f	105/95/75	105/95/65	105/95/65	105/90/55	105/90/50	105/80/65
e	110/100/80	110/100/70	110/100/70	110/95/60	110/95/55	110/85/70
d	115/105/85	115/105/75	115/105/75	115/100/65	115/100/60	115/90/75
c	120/110/90	120/110/80	120/110/80	125/110/75	120/105/65	120/95/80
b	125/115/95	125/115/85	125/115/85	135/120/85	125/110/70	125/100/85
a	130/120/100	130/120/90	130/120/90	145/130/95	135/120/80	130/105/90

¹⁾ Anchor length in bolt type and grey shaded are standard items. For selection of other anchor length, check availability of the items.

Table 2: Material code for identification of different materials

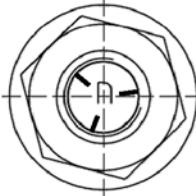
Type	HSA/ HSA-BW (carbon steel)	HSA-R2 (stainless steel grade A2)	HSA-R (stainless steel grade A4)
Material Code	 Letter code without mark	 Letter code with two marks	 Letter code with three marks

Hilti Stud Anchor HSA

Letter code and
Material code

Annex 3

Table 3: Materials

Type	Part	Material	Coating
HSA HSA-BW Carbon Steel	Bolt	Carbon steel, Rupture elongation $A_5 > 8\%$	galvanized ($\geq 5 \mu\text{m}$), EN ISO 4042
	Sleeve	M6: stainless steel A2, M8-M20: Carbon steel	
	Washer	HSA: carbon steel, according Table 4 HSA-BW: carbon steel, according Table 4	
	Hexagon nut	Steel, strength class 8, EN 20898-2	
HSA-R2 Stainless Steel Grade A2	Bolt	Stainless steel A2, 1.4301 or 1.4162 Rupture elongation $A_5 > 8\%$	M6 - M20 coated
	Sleeve	Stainless steel grade A2	-
	Washer	Stainless steel grade A2, EN 10 088	-
	Hexagon nut	Stainless steel grade A2, EN 10 088	M6 - M20 coated
HSA-R Stainless Steel Grade A4	Bolt	Stainless steel grade A4, 1.4401 or 1.4362 Rupture elongation $A_5 > 8\%$	M6 - M20 coated
	Sleeve	Stainless steel grade A2	-
	Washer	Stainless steel grade A4, EN 10 088	-
	Hexagon nut	Stainless steel grade A4, EN 10 088	M6 - M20 coated

Table 4: Geometry washer

Anchor Size		M6	M8	M10	M12	M16	M20
Inner diameter d_1							
HSA, HSA-R2/ R	d_1 [mm]	6,4	8,4	10,5	13,0	17,0	21
HSA-BW	d_1 [mm]	6,4	8,4	10,5	13,0	17,0	22
Outer diameter d_2							
HSA, HSA-R2/ R	d_2 [mm]	12,0	16,0	20,0	24,0	30,0	37,0
HSA-BW	d_2 [mm]	18,0	24,0	30,0	37,0	50,0	60,0
Thickness h							
HSA, HSA-R2/ R	h [mm]	1,6	1,6	2,0	2,5	3,0	3,0
HSA-BW	h [mm]	1,8	2,0	2,5	3,0	3,0	4,0

Diamond drilling



Diamond core bit DD-C TS
Diamond core bit DD-C TL

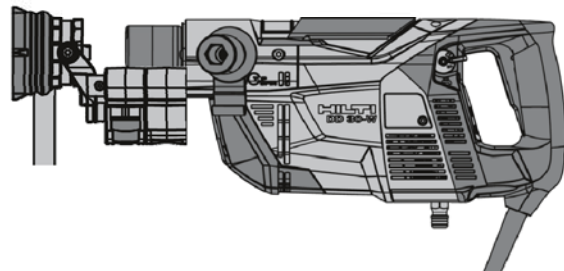



Diamond coring tool DD 30-W

Hilti Stud Anchor HSA

**Materials and
alternative drilling methods**

Annex 4

**Table 5: General installation data, minimum thickness of concrete member,
Minimum spacing and edge distance**

Type	HSA, HSA-BW, HSA-R2, HSA-R																	
Anchor Size	M6			M8			M10			M12			M16			M20		
Setting position	①	②	③	①	②	③	①	②	③	①	②	③	①	②	③	①	②	③
Nominal anchorage depth h_{nom} [mm]	37	47	67	39	49	79	50	60	90	64	79	114	77	92	132	90	115	130
Diameter of clearance hole in the fixture d_f [mm]	7			9			12			14			18			22		
Width across flats S_W [mm]	10			13			17			19			24			30		
Depth of drill hole h_1 [mm]	42	52	72	44	54	84	55	65	95	72	87	122	85	100	140	98	123	138
Min. thickness of concrete member h_{min} [mm]	100	100	120	100	100	120	100	120	160	100	140	180	140	160	180	160	220	220
Hammer drilling (HD) 																		
Nominal diameter of drill bit d_o [mm]	6			8			10			12			16			20		
Cutting diameter of drill bit d_{cut} [mm]	6,40			8,45			10,45			12,5			16,5			20,55		
Diamond drilling (DD) 																		
Diamond coring system	-			-			-			DD 30-W			DD 30-W			DD 30-W		
Core bit	-			-			-			DD-C 12 TS DD-C 12 TL			DD-C 16 TS DD-C 16 TL			DD-C 20 TS DD-C 20 TL		
Standard installation torque and the required minimum edge and space distance																		
Standard installation torque T_{inst} [Nm]	5			15 ¹⁾			25 ¹⁾			50 ¹⁾			80 ¹⁾			200		
Minimum spacing s_{min} [mm]	35	35	35	35	35	35	50	50	50	70	70	70	90	90	90	195	175	175
Minimum edge distance c_{min} [mm]	35	35	35	40	35	35	50	40	40	70	65	55	80	75	70	130	120	120
Maximum installation torque and the required minimum edge and space distance																		
Max. installation torque moment T_{max} [Nm]	-			20			35			80			150			250		
Required edge and spacing for maximum installation torque moment																		
Minimum spacing s_{min} [mm]	-			35			40			50			80			120		
Minimum edge distance c_{min} [mm]	-			100			150			190			200			225		

¹⁾ Alternatively, the anchor can be tightened with an impact screw driver in combination with a special socket with the required setting time (see Annex 7)

Hilti Stud Anchor HSA

Annex 5

**General installation data, minimum thickness of concrete member,
Minimum spacing and edge distance**

Setting instruction for HSA, HSA-BW, HSA-R2 and HSA-R M6 – M20

Drill and clean borehole

Standard drilling method

M6 – M20: Hammer drilling (HD)

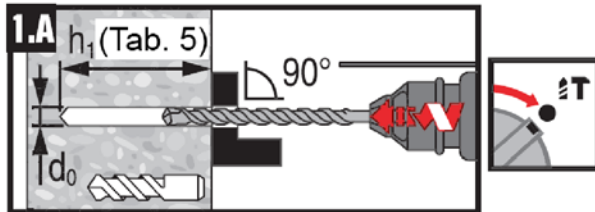

Alternative drilling method

M12 – M20: Diamond drilling (DD)

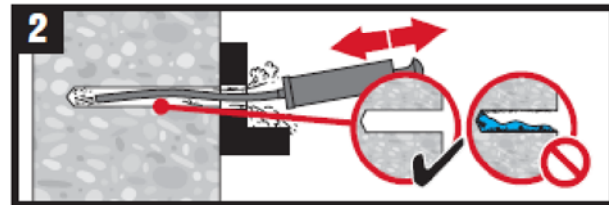
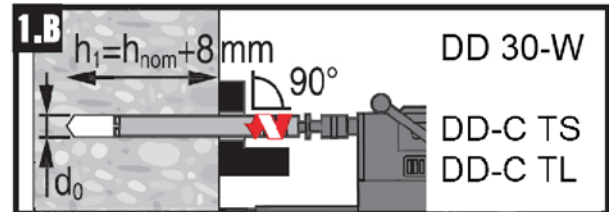

Install anchor with hammer or machine setting tool

Standard setting method

M6 – M20: Hammer setting

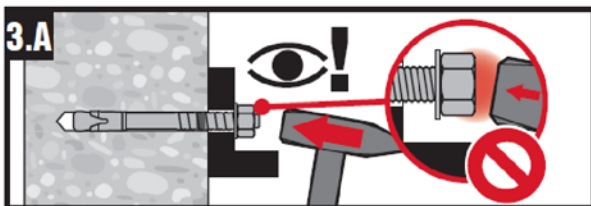

Alternative setting method

M8 – M16: Machine setting

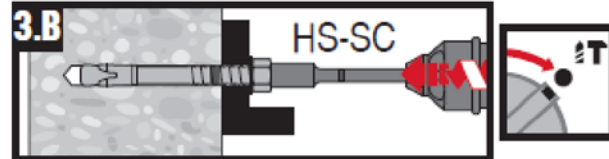

Check setting

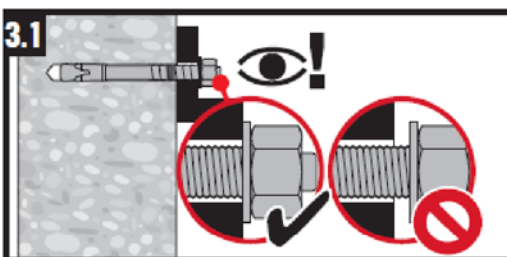

Tightening the anchor

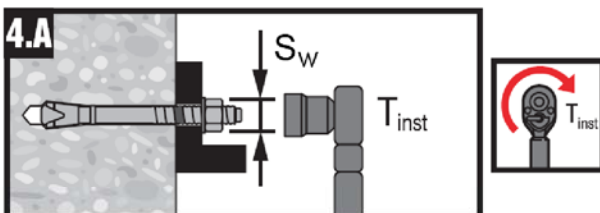

Hilti Stud Anchor HSA

Annex 6

Setting instruction

Table 6: Machine tightening of the anchor for standard installation torque

Type	HSA, HSA-BW, HSA-R2, HSA-R																	
	M6			M8			M10			M12			M16			M20		
Setting position	①	②	③	①	②	③	①	②	③	①	②	③	①	②	③	①	②	③
Nominal anchorage depth h_{nom} [mm]	37	47	67	39	49	79	50	60	90	64	79	114	77	92	132	90	115	130
Standard installation torque T_{inst} [Nm]	-			15			25			50			80			-		
Setting tool				S-TB HSA M8			S-TB HSA M10			S-TB HSA M12			S-TB HSA M16					
Impact screw driver	-			Hilti SIW 14-A Hilti SIW 22-A									Hilti SIW 22T-A			-		
Speed	HSA, HSA-BW			1			1			3			_1)					
	HSA-R2, HSA-R			3			3											
Setting time t_{set} [sec.]	4																	

¹⁾ The impact screw driver operates with a fixed speed.

Setting instruction for HSA, HSA-BW, HSA-R2 and HSA-R M8 – M16

Tightening the anchor - alternatively with impact screw driver and special socket

Selecting the impact screw driver, battery and special socket

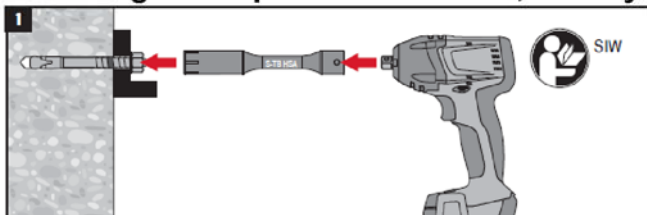

				S-TB HSA M8	S-TB HSA M10	S-TB HSA M12	S-TB HSA M16
SIW 14-A	14V	1.6Ah / 3.3Ah	✓	✓	✓	-	
SIW 22-A	22V	1.6Ah / 2.6Ah / 3.3Ah	✓	✓	✓	-	
SIW 22T-A	22V	2.6Ah / 3.3Ah	-	-	-	✓	

Selecting the speed setting and state of charge of the battery

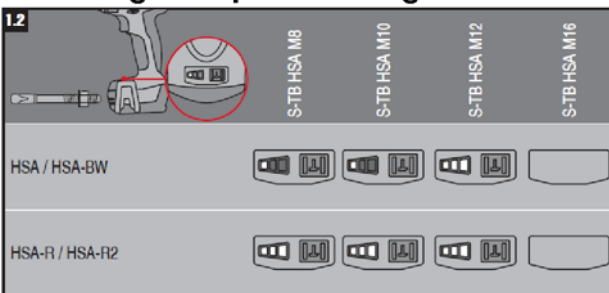

	$\leq 5^\circ$	$5^\circ \dots 10^\circ$	$> 10^\circ$
HSA / HSA-BW	-	-	-
HSA-R / HSA-R2	-	-	✓
	-	-	✓
	-	✓	✓

Tighten the anchor and check the installation

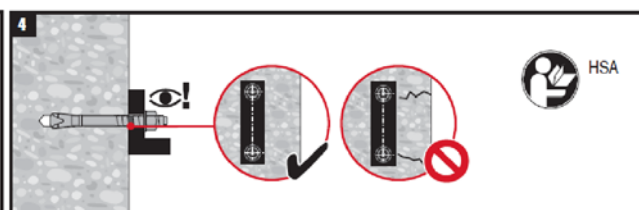
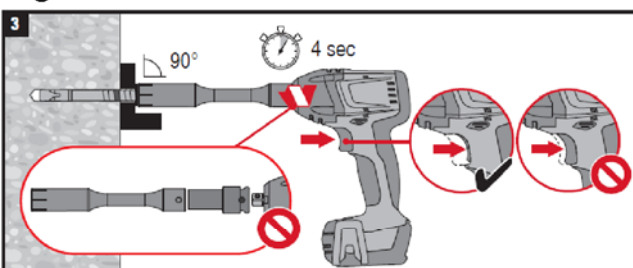

Hilti Stud Anchor HSA

Annex 7

Machine tightening of the anchor
General installation data and setting instruction

Table 7: Characteristic resistance for tension loads

Design method A according ETAG 001, Annex C

Type	HSA, HSA-BW, HSA-R2, HSA-R																		
Anchor Size	M6			M8			M10			M12			M16			M20			
Setting position	①	②	③	①	②	③	①	②	③	①	②	③	①	②	③	①	②	③	
Nominal anchorage depth h_{nom} [mm]	37 ¹⁾	47	67	39 ¹⁾	49	79	50	60	90	64	79	114	77	92	132	90	115	130	
Steel failure																			
Characteristic resistance HSA/ HSA-BW $N_{Rk,s}$ [kN]	9,0			16,5			28,0			41,4			82,6			123,9			
Characteristic resistance HSA-R2/ HSA-R $N_{Rk,s}$ [kN]	12,2			18,3			35,0			44,6			87,7			95,9			
Partial safety factor γ_{Ms} ²⁾ [-]	1,4																		
Pull out failure																			
Characteristic resistance in non-cracked concrete $N_{Rk,p}$ [kN]	6,0	7,5	9,0	- ³⁾	- ³⁾	16	- ³⁾	- ³⁾	25	- ³⁾	- ³⁾	35	- ³⁾	- ³⁾	50	- ³⁾	- ³⁾	- ³⁾	
Partial safety factor γ_{Mp} ²⁾ [-]	1,5 ⁴⁾																		
Increasing factor for $N_{Rk,p}$ Ψ_c ⁵⁾ [-]	$\Psi_c = \left(\frac{f_{ck,cube}}{25} \right)^{0,5}$																		
Concrete cone and splitting failure⁶⁾																			
Effective anchorage depth h_{ef} [mm]	30	40	60	30	40	70	40	50	80	50	65	100	65	80	120	75	100	115	
Partial safety factor γ_{Mc} ²⁾ / γ_{Msp} ²⁾ [-]	1,5 ⁴⁾																		
Spacing	$s_{cr,N}$ [mm]	90	120	180	90	120	210	120	150	240	150	195	300	195	240	360	225	300	345
	$s_{cr,sp}$ [mm]	100	120	130	130	180	200	190	210	290	200	250	310	230	280	380	260	370	400
Edge distance	$c_{cr,N}$ [mm]	45	60	90	45	60	105	60	75	120	75	97,5	150	97,5	120	180	113	150	173
	$c_{cr,sp}$ [mm]	50	60	65	65	90	100	95	105	145	100	125	155	115	140	190	130	185	200

¹⁾ Use is restricted to anchoring of structural components which are statically indeterminant.

²⁾ In absence of other national regulations.

³⁾ Pull-out failure is not decisive for design.

⁴⁾ The installation safety factor $\gamma_2 = 1,0$ is included.

⁵⁾ Use concrete strength class according EN 206-1, the maximum concrete strength is limited to $f_{ck,cube} = 60$ N/mm².

⁶⁾ To give proof of splitting failure due to loading use the smaller value of $N_{Rk,c}^0$ and $N_{Rk,p}$ in equation 5.3 according to ETAG 001 Annex C.

Hilti Stud Anchor HSA

Annex 8

**Characteristic resistance in tension loads
Design method A acc. ETAG 001, Annex C**

**Table 8: Characteristic resistance for shear loads for
Design method A according **ETAG 001, Annex C****

Type	HSA, HSA-BW, HSA-R2, HSA-R																	
	M6			M8			M10			M12			M16			M20		
Setting position	①	②	③	①	②	③	①	②	③	①	②	③	①	②	③	①	②	③
Nominal anchorage depth h_{nom} [mm]	37 ¹⁾	47	67	39 ¹⁾	49	79	50	60	90	64	79	114	77	92	132	90	115	130
Steel failure without lever arm																		
Characteristic resistance HSA/ HSA-BW $V_{Rk,s}$ [kN]	6,5			10,6			18,9			29,5			51,0			85,8		
Characteristic resistance HSA-R2/ HSA-R $V_{Rk,s}$ [kN]	7,2			12,3			22,6			29,3			56,5			91,9		
Steel failure with lever arm																		
Characteristic resistance HSA/ HSA-BW $M^0_{Rk,s}$ [Nm]	9,9			21,7			48,6			91,7			216,4			450,9		
Characteristic resistance HSA-R2/ HSA-R $M^0_{Rk,s}$ [Nm]	9,9			21,0			48,6			76,0			199,8			405,7		
Partial safety factor $\gamma_{Ms}^{2)}$ [-]	1,25																	
Concrete pry-out failure																		
k-Factor ³⁾ k [-]	1	1	2	1	1,5	2	2,4	2,4	2,4	2	2	2	2,9	2,9	2,9	2	3,5	3,5
Partial safety factor $\gamma_{Mc}^{2)}$ [-]	1,5 ⁴⁾																	
Concrete edge failure																		
Effective length of anchor l_f [mm]	30	40	60	30	40	70	40	50	80	50	65	100	65	80	120	75	100	115
Partial safety factor $\gamma_{Mc}^{2)}$ [-]	1,5 ⁴⁾																	
Outside diameter of the anchor d_{nom} [mm]	6			8			10			12			16			20		

¹⁾ Use is restricted to anchoring for multiple use for non-structural applications.

²⁾ In absence of other national regulations.

³⁾ Factor of equation (5.6), ETAG 001, Annex C § 5.2.3.3 Concrete pry-out failure.

⁴⁾ The installation safety factor $\gamma_2 = 1,0$ is included.

Hilti Stud Anchor HSA

Annex 9

Characteristic resistance for shear loads
Design method A acc. **ETAG 001, Annex C**

**Table 9: Characteristic values for tension loads
for design method A acc. CEN/TS 1992-4**

Type	HSA, HSA-BW, HSA-R2, HSA-R																		
Anchor Size	M6			M8			M10			M12			M16			M20			
Setting position	①	②	③	①	②	③	①	②	③	①	②	③	①	②	③	①	②	③	
Nominal anchorage depth h_{nom} [mm]	37 ¹⁾	47	67	39 ¹⁾	49	79	50	60	90	64	79	114	77	92	132	90	115	130	
Steel failure																			
Characteristic resistance HSA/ HSA-BW $N_{Rk,s}$ [kN]	9,0			16,5			28,0			41,4			82,6			123,9			
Characteristic resistance HSA-R2/ HSA-R $N_{Rk,s}$ [kN]	12,2			18,3			35,0			44,6			87,7			95,9			
Partial safety factor γ_{Ms} ²⁾ [-]	1,4																		
Pull out failure																			
Characteristic resistance in non-cracked concrete $N_{Rk,p}$ [kN]	6,0	7,5	9,0	- ³⁾	- ³⁾	16	- ³⁾	- ³⁾	25	- ³⁾	- ³⁾	35	- ³⁾	- ³⁾	50	- ³⁾	- ³⁾	- ³⁾	
Partial safety factor γ_{Mp} ²⁾ [-]	1,5 ⁵⁾																		
Increasing factor for $N_{Rk,p}$ Ψ_c ⁴⁾ [-]	$\Psi_c = \left(\frac{f_{ck,cube}}{25} \right)^{0,5}$																		
Concrete cone and splitting failure																			
Effective anchorage depth h_{ef} [mm]	30	40	60	30	40	70	40	50	80	50	65	100	65	80	120	75	100	115	
Factor for non-cracked concrete k_{ucr} [-]	10,1																		
Partial safety factor γ_{Mc} ²⁾ γ_{Msp} ²⁾ [-]	1,5 ⁵⁾																		
Spacing	$S_{cr,N}$ [mm]	90	120	180	90	120	210	120	150	240	150	195	300	195	240	360	225	300	345
	$S_{cr,sp}$ [mm]	100	120	130	130	180	200	190	210	290	200	250	310	230	280	380	260	370	400
Edge distance	$C_{cr,N}$ [mm]	45	60	90	45	60	105	60	75	120	75	97,5	150	97,5	120	180	113	150	173
	$C_{cr,sp}$ [mm]	50	60	65	65	90	100	95	105	145	100	125	155	115	140	190	130	185	200

¹⁾ Use is restricted to anchoring of structural components which are statically indeterminant

²⁾ In absence of other national regulations.

³⁾ Pull-out failure is not decisive for design

⁴⁾ Use concrete strength class according EN 206-1, the maximum concrete strength is limited to $f_{ck,cube} = 60$ N/mm²

⁵⁾ The installation safety factor $\gamma_2 = 1,0$ is included

Hilti Stud Anchor HSA

Annex 10

Characteristic resistance for tension loads
Design method A acc. CEN/TS 1992-4

**Table 10: Characteristic values for shear loads
for design method A acc. CEN/TS 1992-4**

Type	HSA, HSA-BW, HSA-R2, HSA-R																	
	M6			M8			M10			M12			M16			M20		
Setting position	①	②	③	①	②	③	①	②	③	①	②	③	①	②	③	①	②	③
Nominal anchorage depth h_{nom} [mm]	37 ¹⁾	47	67	39 ¹⁾	49	79	50	60	90	64	79	114	77	92	132	90	115	130
Steel failure without lever arm																		
Characteristic resistance HSA/ HSA-BW $V_{Rk,s}$ [kN]	6,5			10,6			18,9			29,5			51,0			85,8		
Characteristic resistance HSA-R2/ HSA-R $V_{Rk,s}$ [kN]	7,2			12,3			22,6			29,3			56,5			91,9		
Factor considering ductility k_2 [-]	1,0																	
Steel failure with lever arm																		
Characteristic resistance HSA/ HSA-BW $M^0_{Rk,s}$ [Nm]	9,9			21,7			48,6			91,7			216,4			450,9		
Characteristic resistance HSA-R2/ HSA-R $M^0_{Rk,s}$ [Nm]	9,9			21,0			48,6			76,0			199,8			405,7		
Partial safety factor $\gamma_{Ms}^{2)}$ [-]	1,25																	
Concrete pry-out failure																		
k-Factor ³⁾ k_3 [-]	1	1	2	1	1,5	2	2,4	2,4	2,4	2	2	2	2,9	2,9	2,9	2	3,5	3,5
Partial safety factor $\gamma_{Mc}^{2)}$ [-]	1,5 ⁴⁾																	
Concrete edge failure																		
Effective length of anchor l_f [mm]	30	40	60	30	40	70	40	50	80	50	65	100	65	80	120	75	100	115
Partial safety factor $\gamma_{Mc}^{2)}$ [-]	1,5 ⁴⁾																	
Outside diameter of the anchor d_{nom} [mm]	6			8			10			12			16			20		

¹⁾ Use is restricted to anchoring for multiple use for non-structural applications.

²⁾ In absence of other national regulations.

³⁾ Factor in equation (16), CEN/TS 1992-4-4, 6.2.2.3.

⁴⁾ The installation safety factor $\gamma_2 = 1,0$ is included.

Hilti Stud Anchor HSA

Annex 11

Characteristic resistance for shear loads
Design method A acc. CEN/TS 1992-4

Table 11: Displacements under tension loads

Type	HSA, HSA-BW, HSA-R2, HSA-R																		
Anchor Size	M6			M8			M10			M12			M16			M20			
Setting position	①	②	③	①	②	③	①	②	③	①	②	③	①	②	③	①	②	③	
Nominal anchorage depth h_{nom} [mm]	37	47	67	39	49	79	50	60	90	64	79	114	77	92	132	90	115	130	
Tension load for C20/25 to C50/50 N [kN]	2,9	3,6	4,3	4,0	6,1	7,6	6,1	8,5	11,9	8,5	12,6	16,7	12,6	17,2	23,8	16,6	25,1	30,8	
Displacement	δ_{N0} [mm]	0,2	0,6	1,0	0,2	1,2	1,8	0,4	1,1	2,0	0,3	1,4	2,3	0,4	1,3	2,1	0,1	0,8	1,9
	$\delta_{N\infty}$ [mm]	0,6	1,0	1,4	0,6	1,6	2,2	0,8	1,5	2,4	0,7	1,8	2,7	0,8	1,7	2,5	0,5	1,2	2,3

Table 12: Displacements under shear loads

Type	HSA, HSA-BW, HSA-R2, HSA-R																		
Anchor Size	M6			M8			M10			M12			M16			M20			
Setting position	①	②	③	①	②	③	①	②	③	①	②	③	①	②	③	①	②	③	
Nominal anchorage depth h_{nom} [mm]	37	47	67	39	49	79	50	60	90	64	79	114	77	92	132	90	115	130	
Shear load for C20/25 to C50/60 V [kN]	3,7			6,1			10,8			16,7			29,1			49,0			
Displacement	δ_{V0} [mm]	1,6			1,9			2,0			2,1			2,2			2,3		
	$\delta_{V\infty}$ [mm]	2,4			2,9			3,0			3,2			3,3			3,5		

Hilti Stud Anchor HSA

Annex 12

Displacements