

HT Metal frame anchor

	Anchor version	Benefits
	HT	<ul style="list-style-type: none"> - fastening door and window frames - no risk of distortion or forces of constraint - expansion cone can not be lost

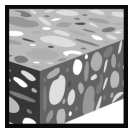

Concrete

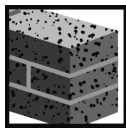

Solid brick

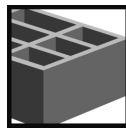

Hollow brick

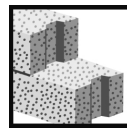
Autoclaved
aerated
concreteFire
resistance

Approvals / certificates

Description	Authority / Laboratory	No. / date of issue
Fire test report	IBMB, Braunschweig	UB 3016/1114-CM / 2006-03-13
Assessment report (fire)	warringtonfire	WF 166402 / 2007-10-26

Basic loading data (for a single anchor)

All data in this section applies to

- Correct setting (See setting instruction)
- No edge distance and spacing influence
- Base material as specified in the table
- Non-cracked concrete: $f_{cc} \geq 20 \text{ N/mm}^2$
- Minimum base material thickness

Characteristic resistance

		HT 8	HT10
Concrete, $f_{cc} = 30 \text{ N/mm}^2$	N_{Rk} [kN]	4,2	5,0
	V_{Rk} [kN]	6,6	7,0
Aerated Concrete PP2 ^{a)}	N_{Rk} [kN]	-	0,3
	V_{Rk} [kN]	-	0,5
Solid brick Mz 12	N_{Rk} [kN]	1,8	2,6
	V_{Rk} [kN]	-	5,0
Sand-lime solid brick, KS 12	N_{Rk} [kN]	1,8	2,6
	V_{Rk} [kN]	-	5,0
Sand-lime hollow brick, KSL	N_{Rk} [kN]	-	1,5
	V_{Rk} [kN]	-	0,5

a) Rotary drilling only

Recommended loads

		HT 8	HT10
Concrete, $f_{cc} = 30 \text{ N/mm}^2$	N_{rec} [kN]	1,4	1,7
	V_{rec} [kN]	0,5	0,5
Aerated Concrete PP2 ^{a)}	N_{rec} [kN]	-	0,1
	V_{rec} [kN]	-	0,15
Solid brick Mz 12	N_{rec} [kN]	0,6	0,8
	V_{rec} [kN]	-	0,5
Sand-lime solid brick, KS 12	N_{rec} [kN]	0,6	0,8
	V_{rec} [kN]	-	0,5
Sand-lime hollow brick, KSL	N_{rec} [kN]	-	0,5
	V_{rec} [kN]	-	0,15

a) Rotary drilling only

Materials

Material quality

Part	Material
Bolt	steel strength 4.8, zinc plated to 5 μm
Sleeve	steel 02 DIN 17162, sendzimir zinc plated to 20 μm

Setting

installation equipment

Anchor size	
Rotary hammer	TE1 – TE16
Other tools	hammer, screwdriver

Setting instruction

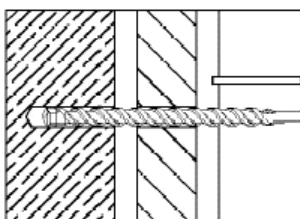

Drill hole with drill bit.

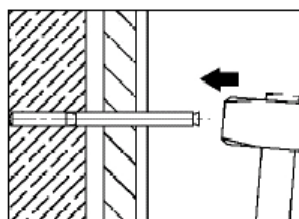

Install anchor.

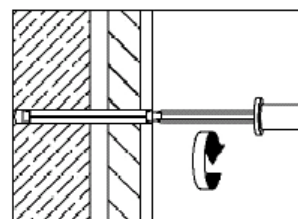

Drive screw into anchor.

For detailed information on installation see instruction for use given with the package of the product.

Setting details: anchor length L and anchorage depth h_{nom}

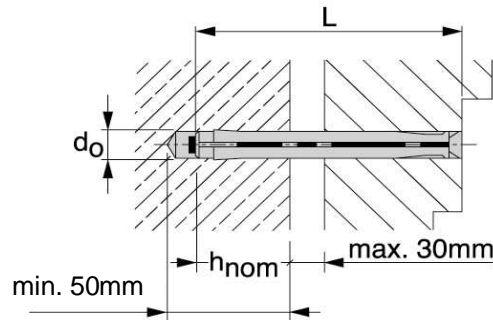

Setting details HT

		HT 8	8x72	8x92	8x112
Nominal diameter of drill bit	d_o	[mm]	8	8	8
Depth of drill hole	h_1	[mm]	50	50	50
Anchorage depth	h_{nom}	[mm]	30	30	30
Anchor length	L	[mm]	72	92	112
Torque moment	T_{inst}	[Nm]	4	4	4
Minimum base material thickness	h_{min}	[mm]	100	100	100
Drill bit			TE-CX-8/17		TE-CX-8/22

		HT 8	8x132	8x152	8x182
Nominal diameter of drill bit	d_o	[mm]	8	8	8
Depth of drill hole	h_1	[mm]	50	50	50
Anchorage depth	h_{nom}	[mm]	30	30	30
Anchor length	L	[mm]	132	152	182
Torque moment	T_{inst}	[Nm]	4	4	4
Minimum base material thickness	h_{min}	[mm]	100	100	100
Drill bit			TE-CX-8/22	TE-CX-8/27	

		HT 10	10x72	10x92	10x112
Nominal diameter of drill bit	d_o	[mm]	10	10	10
Depth of drill hole	h_1	[mm]	50	50	50
Anchorage depth	h_{nom}	[mm]	30	30	30
Anchor length	L	[mm]	72	92	112
Torque moment	$T_{inst}^{a)}$	[Nm]	8/4	8/4	8/4
Minimum base material thickness	h_{min}	[mm]	100	100	100
Drill bit			TE-C-10/17		TE-C-10/22

a) First value: solid base material, second value: hollow base material

		HT 10	10x132	10x152	10x182	10x202
Nominal diameter of drill bit	d_0	[mm]	10	10	10	10
Depth of drill hole	h_1	[mm]	50	50	50	50
Anchorage depth	h_0	[mm]	30	30	30	30
Anchor length	L	[mm]	132	152	182	202
Torque moment	$T_{inst}^{a)}$	[Nm]	8/4	8/4	8/4	8/4
Minimum base material thickness	h_{min}	[mm]	100	100	100	100
Drill bit			TE-C-10/22	TE-C-10/27		TE-C-10/37

a) First value: solid base material, second value: hollow base material