

Approval body for construction products  
and types of construction

Bautechnisches Prüfamt

An institution established by the Federal and  
Laender Governments



## European Technical Assessment

**ETA-11/0493**  
**of 28 July 2017**

English translation prepared by DIBt - Original version in German language

### General Part

Technical Assessment Body issuing the  
European Technical Assessment:

Deutsches Institut für Bautechnik

Trade name of the construction product

Injection system Hilti HIT-HY 200-A

Product family  
to which the construction product belongs

Bonded anchor for use in concrete

Manufacturer

Hilti Aktiengesellschaft  
9494 SCHAAN  
FÜRSTENTUM LIECHTENSTEIN

Manufacturing plant

Hilti Werke

This European Technical Assessment  
contains

39 pages including 3 annexes

This European Technical Assessment is  
issued in accordance with Regulation (EU)  
No 305/2011, on the basis of

Guideline for European technical approval of "Metal  
anchors for use in concrete", ETAG 001 Part 5: "Bonded  
anchors", April 2013,  
used as European Assessment Document (EAD)  
according to Article 66 Paragraph 3 of Regulation (EU)  
No 305/2011.

This version replaces

ETA-11/0493 issued on 3 February 2017

**European Technical Assessment**

**ETA-11/0493**

English translation prepared by DIBt

Page 2 of 39 | 28 July 2017

The European Technical Assessment is issued by the Technical Assessment Body in its official language. Translations of this European Technical Assessment in other languages shall fully correspond to the original issued document and shall be identified as such.

Communication of this European Technical Assessment, including transmission by electronic means, shall be in full. However, partial reproduction may only be made with the written consent of the issuing Technical Assessment Body. Any partial reproduction shall be identified as such.

This European Technical Assessment may be withdrawn by the issuing Technical Assessment Body, in particular pursuant to information by the Commission in accordance with Article 25(3) of Regulation (EU) No 305/2011.

**Specific Part**

**1 Technical description of the product**

The Injection system Hilti HIT-HY 200-A is a bonded anchor consisting of a foil pack with injection mortar Hilti HIT-HY 200-A and a steel element according to Annex A.

The steel element is placed into a drilled hole filled with injection mortar and is anchored via the bond between metal part, injection mortar and concrete.

The product description is given in Annex A.

**2 Specification of the intended use in accordance with the applicable European Assessment Document**

The performances given in Section 3 are only valid if the anchor is used in compliance with the specifications and conditions given in Annex B.

The verifications and assessment methods on which this European Technical Assessment is based lead to the assumption of a working life of the anchor of at least 50 years. The indications given on the working life cannot be interpreted as a guarantee given by the producer, but are to be regarded only as a means for choosing the right products in relation to the expected economically reasonable working life of the works.

**3 Performance of the product and references to the methods used for its assessment**

**3.1 Mechanical resistance and stability (BWR 1)**

Essential characteristic	Performance
Characteristic resistance under static and quasi-static action, displacements	See Annex C1 to C12
Characteristic resistance for seismic performance categories C1 and C2, displacements	See Annex C13 to C17

**3.2 Safety in case of fire (BWR 2)**

Essential characteristic	Performance
Reaction to fire	Anchorage satisfy requirements for Class A1
Resistance to fire	No performance determined (NPD)

**3.3 Hygiene, health and the environment (BWR 3)**

Regarding dangerous substances there may be requirements (e.g. transposed European legislation and national laws, regulations and administrative provisions) applicable to the products falling within the scope of this European Technical Assessment. In order to meet the provisions of Regulation (EU) No 305/2011, these requirements need also to be complied with, when and where they apply.

**3.4 Safety in use (BWR 4)**

The essential characteristics regarding Safety in use are included under the Basic Works Requirement Mechanical resistance and stability.

**4 Assessment and verification of constancy of performance (AVCP) system applied, with reference to its legal base**

In accordance with guideline for European technical approval ETAG 001, April 2013 used as European Assessment Document (EAD) according to Article 66 Paragraph 3 of Regulation (EU) No 305/2011 the applicable European legal act is: [96/582/EC].

The system to be applied is: 1

**5 Technical details necessary for the implementation of the AVCP system, as provided for in the applicable European Assessment Document**

Technical details necessary for the implementation of the AVCP system are laid down in the control plan deposited at Deutsches Institut für Bautechnik.

Issued in Berlin on 28 July 2017 by Deutsches Institut für Bautechnik

BD Dipl.-Ing. Andreas Kummerow  
Head of Department

*beglaubigt:*  
Lange

## Installed condition

**Figure A1:**  
Threaded rod and HIT-V-..., AM 8.8

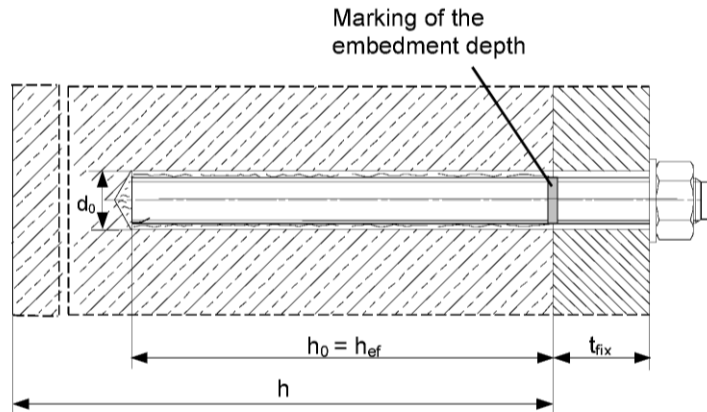

**Figure A2:**  
Threaded rod and HIT-V-..., AM 8.8, with Hilti Filling Set

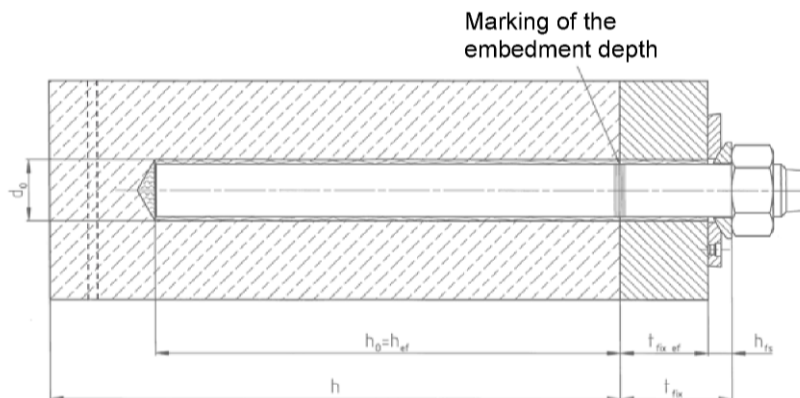

**Figure A3:**  
Internally threaded sleeve HIS-(R)N

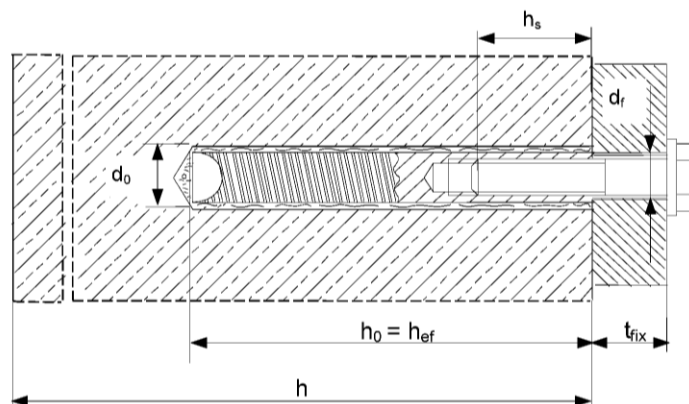

Injection System Hilti HIT-HY 200-A

Product description  
Installed condition

Annex A1

## Installed condition

**Figure A4:**  
**Reinforcing bar**

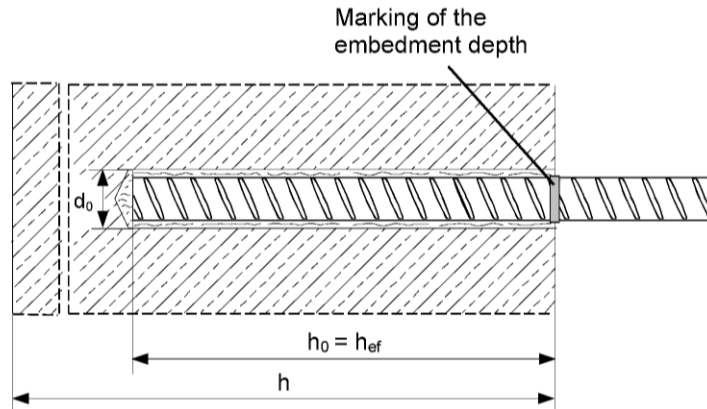

**Injection System Hilti HIT-HY 200-A**

**Product description**  
Installed condition

**Annex A2**

## Product description: Injection mortar and steel elements

**Injection mortar Hilti HIT-HY 200-A:** hybrid system with aggregate  
330 ml and 500 ml

Marking:  
HILTI-HIT  
Production number and  
production line  
Expiry date mm/yyyy



Product name: "Hilti HIT-HY 200-A"

### Static mixer Hilti HIT-RE-M



### Steel elements

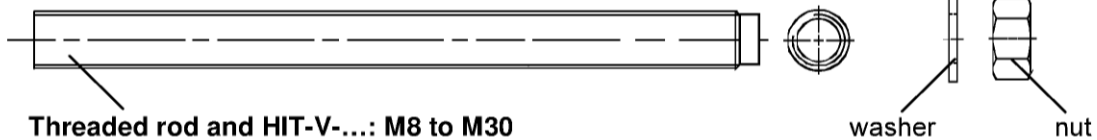

Threaded rod and HIT-V-...: M8 to M30

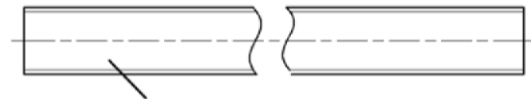

Hilti meter rod AM 8.8 electroplated zinc coated, AM HDG 8.8 hot dip galvanized  
M8 to M30, 1m to 3m

Commercial standard threaded rod:

- Materials and mechanical properties according to Table A1.
- Inspection certificate 3.1 according to EN 10204:2004. The document shall be stored.
- Marking of embedment depth.

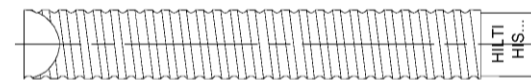

Internally threaded sleeve: HIS-(R)N M8 to M20

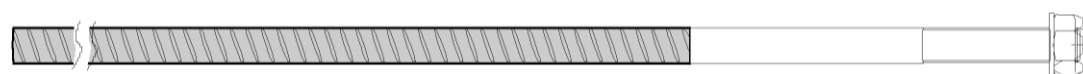

Hilti Tension Anchor: HZA M12 to M27 and HZA-R M12 to M24

**Injection System Hilti HIT-HY 200-A**

**Product description**  
Injection mortar / Static mixer / Steel elements

**Annex A3**

## Product description: Injection mortar and steel elements



### Reinforcing bar (rebar): $\phi$ 8 to $\phi$ 32

- Materials and mechanical properties according to Table A1
- Dimensions according to Annex B6

### Hilti Filling Set to fill the annular gap between anchor and fixture

#### Sealing washer

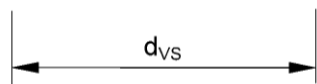
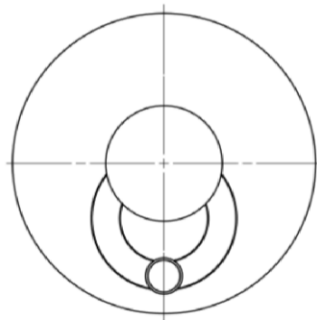

#### Spherical washer

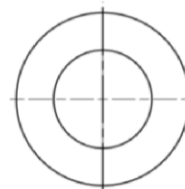

Filling Set		M16	M20	M24
Diameter of sealing washer	$d_{VS}$ [mm]	56	60	70
Thickness of sealing washer	$h_{VS}$ [mm]	6		

## Injection System Hilti HIT-HY 200-A

### Product description

Injection mortar / Static mixer / Steel elements

Annex A4



**Table A1: Materials**

Designation	Material
<b>Reinforcing bars</b>	
Rebar: EN 1992-1-1: 2004 and AC:2010, Annex C	Bars and de-coiled rods class B or C with $f_{yk}$ and $k$ according to NDP or NCL of EN 1992-1-1/NA:2013 $f_{uk} = f_{tk} = k \cdot f_{yk}$
<b>Metal parts made of zinc coated steel</b>	
Threaded rod, HIT-V-5.8(F)	Strength class 5.8, $f_{uk} = 500 \text{ N/mm}^2$ , $f_{yk} = 400 \text{ N/mm}^2$ , Elongation at fracture ( $l_0=5d$ ) > 8% ductile Electroplated zinc coated $\geq 5 \mu\text{m}$ , (F) hot dip galvanized $\geq 45 \mu\text{m}$
Threaded rod, HIT-V-8.8(F)	Strength class 8.8, $f_{uk} = 800 \text{ N/mm}^2$ , $f_{yk} = 640 \text{ N/mm}^2$ , Elongation at fracture ( $l_0=5d$ ) > 12% ductile Electroplated zinc coated $\geq 5 \mu\text{m}$ , (F) hot dip galvanized $\geq 45 \mu\text{m}$
Hilti Meter rod, AM 8.8 (HDG)	Strength class 8.8, $f_{uk} = 800 \text{ N/mm}^2$ , $f_{yk} = 640 \text{ N/mm}^2$ Elongation at fracture ( $l_0 = 5d$ ) > 12% ductile, Electroplated zinc coated $\geq 5 \mu\text{m}$ , (HDG) hot dip galvanized $\geq 45 \mu\text{m}$
Hilti tension anchor HZA	Round steel with threaded part: electroplated zinc coated $\geq 5 \mu\text{m}$ Rebar: Bars class B according to NDP or NCL of EN 1992-1-1/NA:2013
Internally threaded sleeve HIS-N	Electroplated zinc coated $\geq 5 \mu\text{m}$
Washer	Electroplated zinc coated $\geq 5 \mu\text{m}$ , hot dip galvanized $\geq 45 \mu\text{m}$
Nut	Strength class of nut adapted to strength class of threaded rod Electroplated zinc coated $\geq 5 \mu\text{m}$ , (F) hot dip galvanized $\geq 45 \mu\text{m}$
Hilti filling set (F)	Filling washer: Electroplated zinc coated $\geq 5 \mu\text{m}$ , (F) hot dip galvanized $\geq 45 \mu\text{m}$ Spherical washer: Electroplated zinc coated $\geq 5 \mu\text{m}$ , (F) hot dip galvanized $\geq 45 \mu\text{m}$ Lock nut: Electroplated zinc coated $\geq 5 \mu\text{m}$ , (F) hot dip galvanized $\geq 45 \mu\text{m}$
<b>Metal parts made of stainless steel</b>	
Threaded rod, HIT-V-R	For $\leq \text{M24}$ : strength class 70, $f_{uk} = 700 \text{ N/mm}^2$ , $f_{yk} = 450 \text{ N/mm}^2$ ; For $> \text{M24}$ : strength class 50, $f_{uk} = 500 \text{ N/mm}^2$ , $f_{yk} = 210 \text{ N/mm}^2$ ; Elongation at fracture ( $l_0=5d$ ) > 8% ductile Stainless steel 1.4401, 1.4404, 1.4578, 1.4571, 1.4439, 1.4362 EN 10088-1:2014
Hilti tension anchor HZA-R	Round steel with threaded part: Stainless steel 1.4404, 1.4362, 1.4571 EN 10088-1:2014 Rebar: Bars class B according to NDP or NCL of EN 1992-1-1/NA:2013
Internally threaded sleeve HIS-RN	Stainless steel 1.4401, 1.4571 EN 10088-1:2014
Washer	Stainless steel 1.4401, 1.4404, 1.4578, 1.4571, 1.4439, 1.4362 EN 10088-1:2014
Nut	Strength class of nut adapted to strength class of threaded rod Stainless steel 1.4401, 1.4404, 1.4578, 1.4571, 1.4439, 1.4362 EN 10088-1:2014

**Injection System Hilti HIT-HY 200-A**

**Product description**  
Materials

**Annex A5**

**Metal parts made of high corrosion resistant steel**

Threaded rod HIT-V-HCR	For $\leq$ M20: $f_{uk} = 800 \text{ N/mm}^2$ , $f_{yk} = 640 \text{ N/mm}^2$ , For $>$ M20: $f_{uk} = 700 \text{ N/mm}^2$ , $f_{yk} = 400 \text{ N/mm}^2$ , Elongation at fracture ( $l_0=5d$ ) $>$ 8% ductile High corrosion resistant steel 1.4529, 1.4565 EN 10088-1:2014
Washer	High corrosion resistant steel 1.4529, 1.4565 EN 10088-1:2014
Nut	Strength class of nut adapted to strength class of threaded rod High corrosion resistant steel 1.4529, 1.4565 EN 10088-1:2014

**Injection System Hilti HIT-HY 200-A**

**Product description**  
Materials

**Annex A6**

## Specifications of intended use

### Anchorage subject to:

- Static and quasi static loading.
- Seismic performance category C1 and C2 (see Table B1).







### Base material:-

- Reinforced or unreinforced normal weight concrete according to EN 206-1:2000.
- Strength classes C20/25 to C50/60 according to EN 206-1:2000.
- Cracked and non-cracked concrete.

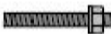
### Temperature in the base material:

- **at installation**  
-10 °C to +40 °C
- **in-service**  
Temperature range I: -40 °C to +40 °C  
(max. long term temperature +24 °C and max. short time temperature +40 °C)  
Temperature range II: -40 °C to +80 °C  
(max. long term temperature +50 °C and max. short time temperature +80 °C)  
Temperature range III: -40 °C to +120 °C  
(max. long term temperature +72 °C and max. short time temperature +120 °C)

**Table B1: Specifications of intended use**

Elements	HIT-HY 200-A with ...			
	HIT-V ... AM 8.8 	Rebar 	HZA(-R) 	HIS-(R)N 
Hammer drilling with hollow drill bit TE-CD or TE-YD 	✓	✓	✓	✓
Hammer drilling 	✓	✓	✓	✓
Static and quasi static loading in cracked and non-cracked concrete	M8 to M30	φ 8 to φ 32	M12 to M27	M8 to M20
Seismic performance category C1	M10 to M30	φ 10 to φ 32	M12 to M27	-
Seismic performance category C2	M16 to M24, HIT-V 8.8, AM 8.8 HIT-V-F 8.8, AM HDG 8.8 Commercial standard rod (electroplated zinc coated only)	-	-	-

**Injection System Hilti HIT-HY 200-A**

**Intended Use  
Specifications**

**Annex B1**

**Use conditions (Environmental conditions):**

- Structures subject to dry internal conditions (zinc coated steel, stainless steel or high corrosion resistant steel).
- Structures subject to external atmospheric exposure (including industrial and marine environment) and to permanently damp internal conditions, if no particular aggressive conditions exist (stainless steel or high corrosion resistant steel).
- Structures subject to external atmospheric exposure and to permanently damp internal conditions, if other particular aggressive conditions exist (high corrosion resistant steel).

Note: Particular aggressive conditions are e.g. permanent, alternating immersion in seawater or the splash zone of seawater, chloride atmosphere of indoor swimming pools or atmosphere with extreme chemical pollution (e.g. in desulphurization plants or road tunnels where de-icing products are used).

**Design:**

- Anchorages are designed under the responsibility of an engineer experienced in anchorages and concrete work.
- Verifiable calculation notes and drawings are prepared taking account of the loads to be anchored. The position of the anchor is indicated on the design drawings (e. g. position of the anchor relative to reinforcement or to supports, etc.).
- Anchorages under static or quasi-static loading are designed in accordance with:  
"EOTA Technical Report TR 029, Edition September 2010"
- Anchorages under seismic actions (cracked concrete) are designed in accordance with:  
"EOTA Technical Report TR 045, Edition February 2013"

Anchorages shall be positioned outside of critical regions (e.g. plastic hinges) of the concrete structure. Fastenings in stand-off installation or with a grout layer under seismic action are not covered in this European technical assessment (ETA).

**Installation:**

- Use category: dry or wet concrete (not in flooded holes)
- Overhead installation is admissible
- Anchor installation carried out by appropriately qualified personnel and under the supervision of the person responsible for technical matters of the site.

**Injection System Hilti HIT-HY 200-A**

**Intended Use  
Specifications**

**Annex B2**

**Table B2: Installation parameters of threaded rod and HIT-V-... and AM 8.8**

Threaded rod and HIT-V-... AM 8.8			M8	M10	M12	M16	M20	M24	M27	M30
Diameter of element	d	[mm]	8	10	12	16	20	24	27	30
Nominal diameter of drill bit	d <sub>0</sub>	[mm]	10	12	14	18	22	28	30	35
Effective embedment depth and drill hole depth	h <sub>ef</sub> = h <sub>0</sub>	[mm]	60 to 160	60 to 200	70 to 240	80 to 320	90 to 400	96 to 480	108 to 540	120 to 600
Maximum diameter of clearance hole in the fixture <sup>1)</sup>	d <sub>f</sub>	[mm]	9	12	14	18	22	26	30	33
Thickness of Hilti filling set	h <sub>fs</sub>	[mm]	-	-	-	11	13	15	-	-
Effective fixture thickness with Hilti filling set	t <sub>fix,eff</sub>	[mm]	t <sub>fix,eff</sub> = t <sub>fix</sub> - h <sub>fs</sub>							
Minimum thickness of concrete member	h <sub>min</sub>	[mm]	h <sub>ef</sub> + 30 ≥ 100 mm			h <sub>ef</sub> + 2 · d <sub>0</sub>				
Maximum torque moment	T <sub>max</sub>	[Nm]	10	20	40	80	150	200	270	300
Minimum spacing	s <sub>min</sub>	[mm]	40	50	60	75	90	115	120	140
Minimum edge distance	c <sub>min</sub>	[mm]	40	45	45	50	55	60	75	80

<sup>1)</sup> for larger clearance hole see "TR 029 section 1.1"

**HIT-V-...**

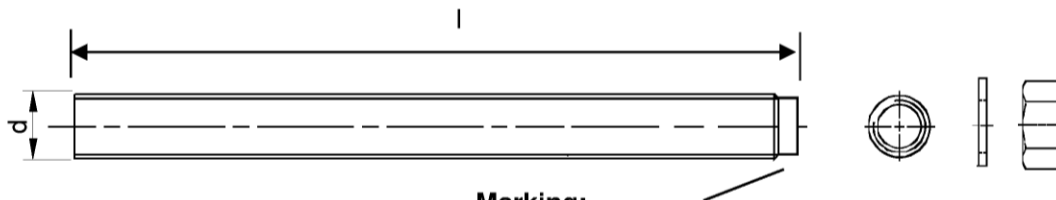

**Marking:**

- 5.8 - l = HIT-V-5.8 M...x l
- 5.8F - l = HIT-V-5.8F M...x l
- 8.8 - l = HIT-V-8.8 M...x l
- 8.8F - l = HIT-V-8.8F M...x l
- R - l = HIT-V-R M ...x l
- HCR - l = HIT-V-HCR M ...x l

**Hilti meter rod AM (HDG) 8.8**

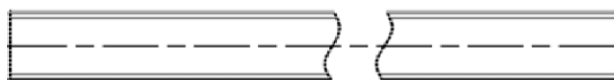

**Injection System Hilti HIT-HY 200-A**

**Intended Use**

Installation parameters of threaded rod, HIT-V-... and AM 8.8

**Annex B3**

**Table B3: Installation parameters of internally threaded sleeve HIS-(R)N**

Internally threaded sleeve HIS-(R)N...	M8	M10	M12	M16	M20
Outer diameter of sleeve d [mm]	12,5	16,5	20,5	25,4	27,6
Nominal diameter of drill bit $d_0$ [mm]	14	18	22	28	32
Effective embedment depth and drill hole depth $h_{ef} = h_0$ [mm]	90	110	125	170	205
Maximum diameter of clearance hole in the fixture <sup>1)</sup> $d_f$ [mm]	9	12	14	18	22
Minimum thickness of concrete member $h_{min}$ [mm]	120	150	170	230	270
Maximum torque moment $T_{max}$ [Nm]	10	20	40	80	150
Thread engagement length min-max $h_s$ [mm]	8-20	10-25	12-30	16-40	20-50
Minimum spacing $s_{min}$ [mm]	60	75	90	115	130
Minimum edge distance $c_{min}$ [mm]	40	45	55	65	90

<sup>1)</sup> for larger clearance hole see "TR 029 section 1.1"

**Internally threaded sleeve HIS-(R)N...**

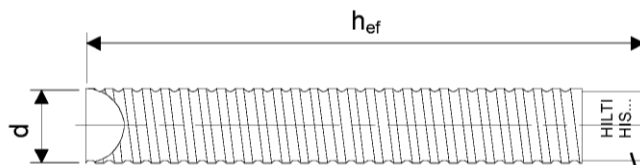

**Marking:**  
Identifying mark - HILTI and  
embossing "HIS-N" (for C-steel)  
embossing "HIS-RN" (for stainless steel)

**Injection System Hilti HIT-HY 200-A**

**Intended Use**

Installation parameters of internally threaded sleeve HIS-(R)N

**Annex B4**

**Table B4: Installation parameters of Hilti tension anchor HZA-R**

Hilti tension anchor HZA-R ...			M12	M16	M20	M24
Rebar diameter	$\phi$	[mm]	12	16	20	25
Nominal embedment depth and drill hole depth	$h_{nom} = h_0$	[mm]	170 to 240	180 to 320	190 to 400	200 to 500
Effective embedment depth ( $h_{ef} = h_{nom} - l_e$ )	$h_{ef}$	[mm]	$h_{nom} - 100$			
Length of smooth shaft	$l_e$	[mm]	100			
Nominal diameter of drill bit	$d_0$	[mm]	16	20	25	32
Maximum diameter of clearance hole in the fixture <sup>1)</sup>	$d_f$	[mm]	14	18	22	26
Maximum torque moment	$T_{max}$	[Nm]	40	80	150	200
Minimum thickness of concrete member	$h_{min}$	[mm]	$h_{nom} + 2 \cdot d_0$			
Minimum spacing	$s_{min}$	[mm]	65	80	100	130
Minimum edge distance	$c_{min}$	[mm]	45	50	55	60

<sup>1)</sup> for larger clearance hole see "TR 029 section 1.1"

**Table B5: Installation parameters of Hilti tension anchor HZA**

Hilti tension anchor HZA...			M12	M16	M20	M24	M27
Rebar diameter	$\phi$	[mm]	12	16	20	25	28
Nominal embedment depth and drill hole depth	$h_{nom} = h_0$	[mm]	90 to 240	100 to 320	110 to 400	120 to 500	140 to 560
Effective embedment depth ( $h_{ef} = h_{nom} - l_e$ )	$h_{ef}$	[mm]	$h_{nom} - 20$				
Length of smooth shaft	$l_e$	[mm]	20				
Nominal diameter of drill bit	$d_0$	[mm]	16	20	25	32	35
Maximum diameter of clearance hole in the fixture <sup>1)</sup>	$d_f$	[mm]	14	18	22	26	30
Maximum torque moment	$T_{max}$	[Nm]	40	80	150	200	270
Minimum thickness of concrete member	$h_{min}$	[mm]	$h_{nom} + 2 \cdot d_0$				
Minimum spacing	$s_{min}$	[mm]	65	80	100	130	140
Minimum edge distance	$c_{min}$	[mm]	45	50	55	60	75

<sup>1)</sup> for larger clearance hole see "TR 029 section 1.1"

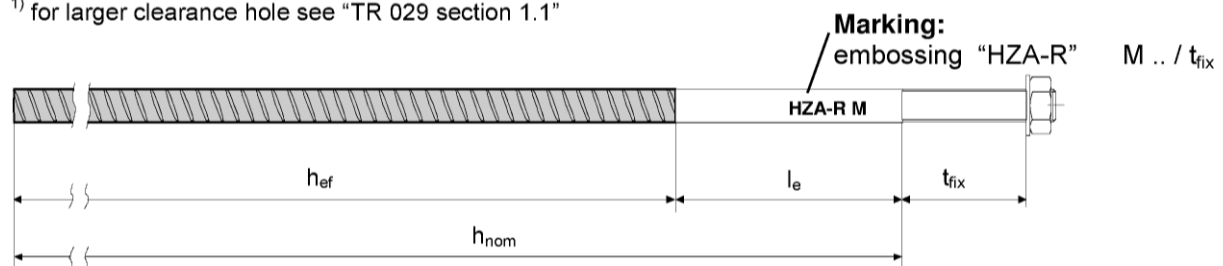

**Injection System Hilti HIT-HY 200-A**

**Intended Use**

Installation parameters of Hilti tension anchor HZA-(R)

**Annex B5**



**Table B6: Installation parameters of reinforcing bar**

Reinforcing bar (rebar)	$\phi$ 8	$\phi$ 10	$\phi$ 12	$\phi$ 14	$\phi$ 16	$\phi$ 20	$\phi$ 25	$\phi$ 26	$\phi$ 28	$\phi$ 30	$\phi$ 32
Diameter $\phi$ [mm]	8	10	12	14	16	20	25	26	28	30	32
Effective embedment depth and drill hole depth $h_{ef} = h_0$ [mm]	60 to 160	60 to 200	70 to 240	75 to 280	80 to 320	90 to 400	100 to 500	104 to 520	112 to 560	120 to 600	128 to 640
Nominal diameter of drill bit $d_0$ [mm]	10 / 12 <sup>1)</sup>	12 / 14 <sup>1)</sup>	14 <sup>1)</sup> / 16 <sup>1)</sup>	18	20	25	32	32	35	37	40
Minimum thickness of concrete member $h_{min}$ [mm]	$h_{ef} + 30 \geq 100$ mm			$h_{ef} + 2 \cdot d_0$							
Minimum spacing $s_{min}$ [mm]	40	50	60	70	80	100	125	130	140	150	160
Minimum edge distance $c_{min}$ [mm]	40	45	45	50	50	65	70	75	75	80	80

<sup>1)</sup> Each of the two given values can be used.

### Reinforcing bar



For rebar bolt

- Minimum value of related rip area  $f_{R,min}$  according to EN 1992-1-1:2004+AC:2010
- Rib height of the bar  $h_{rib}$  shall be in the range  $0,05 \cdot \phi \leq h_{rib} \leq 0,07 \cdot \phi$   
( $\phi$ : Nominal diameter of the bar;  $h_{rib}$ : Rib height of the bar)

**Injection System Hilti HIT-HY 200-A**

**Intended Use**  
Installation parameters of reinforcing bar (rebar)

**Annex B6**



**Table B7: Maximum working time and minimum curing time**









Temperature in the base material T	Maximum working time $t_{work}$	Minimum curing time $t_{cure}$
-10 °C to -5 °C	1,5 hours	7 hours
> -5 °C to 0 °C	50 min	4 hours
> 0 °C to 5 °C	25 min	2 hours
> 5 °C to 10 °C	15 min	75 min
> 10 °C to 20 °C	7 min	45 min
> 20 °C to 30 °C	4 min	30 min
> 30 °C to 40 °C	3 min	30 min

**Injection System Hilti HIT-HY 200-A**

**Intended Use**  
Maximum working time and minimum curing time

**Annex B7**

**Table B8: Parameters of cleaning and setting tools**

Elements				Drill and clean		Installation	
Threaded rod, HIT-V-... AM 8.8	HIS-(R)N	Rebar	HZA-(R)	Hammer drilling		Brush	Piston plug
					hollow drill bit		
							
size	size	size	size	d <sub>0</sub> [mm]	d <sub>0</sub> [mm]	HIT-RB	HIT-SZ
M8	-	φ8	-	10	-	10	-
M10	-	φ8 / φ10	-	12	12 <sup>1)</sup>	12	12
M12	M8	φ10 / φ12	-	14	14 <sup>1)</sup>	14	14
-	-	φ12	M12	16	16	16	16
M16	M10	φ14	-	18	18	18	18
-	-	φ16	M16	20	20	20	20
M20	M12	-	-	22	22	22	22
-	-	φ20	M20	25	25	25	25
M24	M16	-	-	28	28	28	28
M27	-	-	-	30	-	30	30
-	M20	φ25 / φ26	M24	32	32	32	32
M30	-	φ28	M27	35	35	35	35
-	-	φ30	-	37	-	37	37
-	-	φ32	-	40	-	40	40

<sup>1)</sup> To be used in combination with Hilti vacuum cleaner with suction volume ≥ 61 l/s (VC 20/40 –Y in corded mode only).

### Cleaning alternatives

#### Manual Cleaning (MC):

Hilti hand pump for blowing out drill holes with diameters  $d_0 \leq 20$  mm and drill hole depths  $h_0 \leq 10 \cdot d$



#### Compressed air cleaning (CAC):

Air nozzle with an orifice opening of minimum 3,5 mm in diameter.



#### Automatic Cleaning (AC):

Cleaning is performed during drilling with Hilti TE-CD and TE-YD drilling system including vacuum cleaner.



**Injection System Hilti HIT-HY 200-R**

**Intended Use**

Cleaning and setting tools

**Annex B8**

## Installation instruction

### Hole drilling

#### a) Hammer drilling

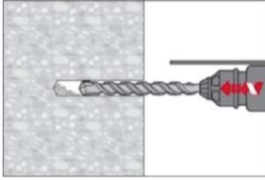

Drill hole to the required embedment depth with a hammer drill set in rotation-hammer mode using an appropriately sized carbide drill bit.

#### b) Hammer drilling with Hilti hollow drill bit

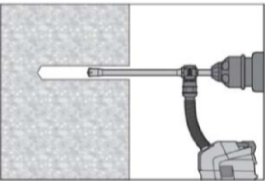

Drill hole to the required embedment depth with an appropriately sized Hilti TE-CD or TE-YD hollow drill bit attached to Hilti vacuum cleaner VC 20/40 (-Y) (suction volume  $\geq 57$  l/s) with automatic cleaning of the filter activated. This drilling system removes the dust and cleans the bore hole during drilling when used in accordance with the user's manual. When using TE-CD size 12 and 14 refer to Table B8.

After drilling is completed, proceed to the "injection preparation" step in the installation instruction.

### Drill hole cleaning

Just before setting an anchor, the drill hole must be free of dust and debris.

#### Manual Cleaning (MC)

##### non-cracked concrete only

for drill hole diameters  $d_0 \leq 20$  mm and drill hole depths  $h_0 \leq 10 \cdot d$

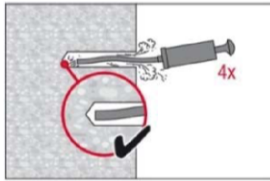

The Hilti hand pump may be used for blowing out drill holes up to diameters  $d_0 \leq 20$  mm and embedment depths up to  $h_{ef} \leq 10 \cdot d$ . Blow out at least 4 times from the back of the drill hole until return air stream is free of noticeable dust.

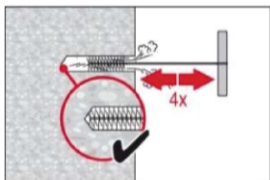

Brush 4 times with the specified brush (see Table B8) by inserting the steel brush Hilti HIT-RB to the back of the hole (if needed with extension) in a twisting motion and removing it. The brush must produce natural resistance as it enters the drill hole (brush  $\varnothing \geq$  drill hole  $\varnothing$ ) - if not the brush is too small and must be replaced with the proper brush diameter.

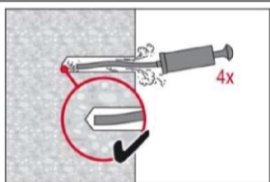

Blow out again with Hilti hand pump at least 4 times until return air stream is free of noticeable dust.

### Injection System Hilti HIT-HY 200-R

Intended Use  
Installation instructions

Annex B9

**Compressed air cleaning (CAC)** for all drill hole diameters  $d_0$  and all drill hole depths  $h_0$

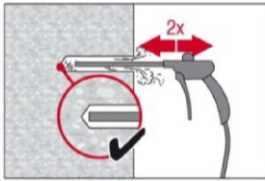

Blow 2 times from the back of the hole (if needed with nozzle extension) over the hole length with oil-free compressed air (min. 6 bar at 6 m<sup>3</sup>/h) until return air stream is free of noticeable dust.  
For drill hole diameters  $\geq 32$  mm the compressor has to supply a minimum air flow of 140 m<sup>3</sup>/h.

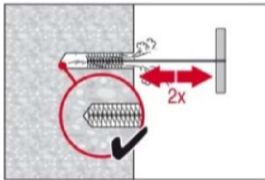

Brush 2 times with the specified brush (see Table B8) by inserting the steel brush Hilti HIT-RB to the back of the hole (if needed with extension) in a twisting motion and removing it.  
The brush must produce natural resistance as it enters the drill hole (brush  $\varnothing \geq$  drill hole  $\varnothing$ ) - if not the brush is too small and must be replaced with the proper brush diameter.

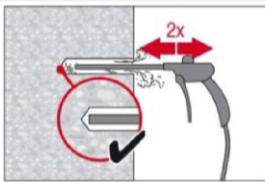

Blow again with compressed air 2 times until return air stream is free of noticeable dust.

**Injection preparation**

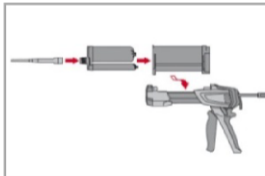

Tightly attach new Hilti mixing nozzle HIT-RE-M to foil pack manifold (snug fit). Do not modify the mixing nozzle.  
Observe the instruction for use of the dispenser.  
Check foil pack holder for proper function. Do not use damaged foil packs / holders.  
Insert foil pack into foil pack holder and put holder into the dispenser.

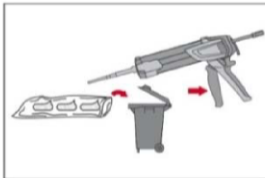

Discard initial adhesive. The foil pack opens automatically as dispensing is initiated. Depending on the size of the foil pack an initial amount of adhesive has to be discarded. Discarded quantities are

2 strokes	for 330 ml foil pack,
3 strokes	for 500 ml foil pack,
4 strokes	for 500 ml foil pack $\leq 5$ °C.

**Injection System Hilti HIT-HY 200-A**

**Intended Use**  
Installation instructions

**Annex B10**

**Inject adhesive** from the back of the drill hole without forming air voids.

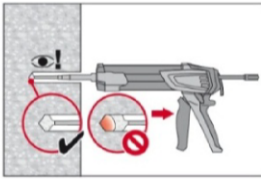

Inject the adhesive starting at the back of the hole, slowly withdrawing the mixer with each trigger pull.  
Fill holes approximately 2/3 full, to ensure that the annular gap between the anchor and the concrete is completely filled with adhesive along the embedment length.

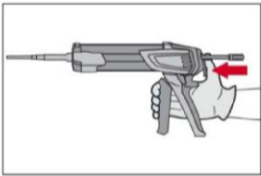

After injection is completed, depressurize the dispenser by pressing the release trigger. This will prevent further adhesive discharge from the mixer.

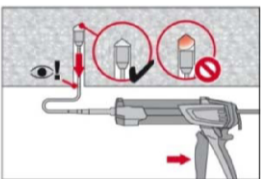

Overhead installation and/or installation with embedment depth  $h_{ef} > 250\text{mm}$ .  
For overhead installation the injection is only possible with the aid of extensions and piston plugs. Assemble HIT-RE-M mixer, extension(s) and appropriately sized piston plug (see Table B8). Insert piston plug to back of the hole and inject adhesive. During injection the piston plug will be naturally extruded out of the drill hole by the adhesive pressure

**Setting the element**

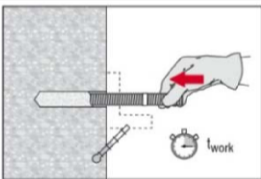

Before use, verify that the element is dry and free of oil and other contaminants.  
Mark and set element to the required embedment depth until working time  $t_{work}$  has elapsed. The working time  $t_{work}$  is given in Table B7.

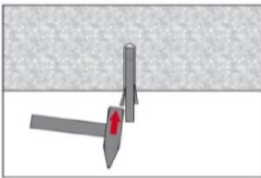

For overhead installation use piston plugs and fix embedded parts with e.g. wedges.

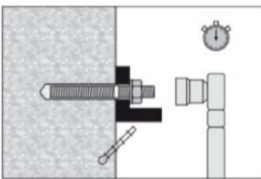

Loading the anchor: After required curing time  $t_{cure}$  (see Table B7) the anchor can be loaded.  
The applied installation torque shall not exceed the values  $T_{max}$  given in Table B2 to Table B5.

**Injection System Hilti HIT-HY 200-A**

**Annex B11**

### Installation of Filling Set

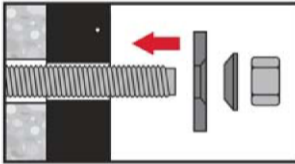

Use Hilti filling set with standard nut. Observe the correct orientation of filling washer and spherical washer.

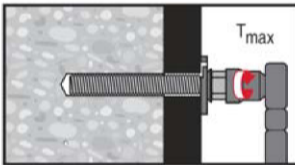

The applied installation torque shall not exceed the values  $T_{max}$  given in Table B2 to Table B5.

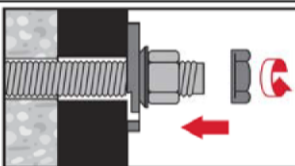

Optional:  
Installation of lock nut. Tighten with a  $\frac{1}{4}$  to  $\frac{1}{2}$  turn. (Not for size M24.)

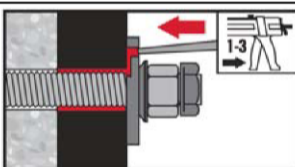

Fill the annular gap between the anchor rod and fixture with 1-3 strokes of Hilti injection mortar HIT-HY 200 A. Follow the installation instructions supplied with the HIT-HY 200 A foil pack. After required curing time  $t_{cure}$  the anchor can be loaded.

**Injection System Hilti HIT-HY 200-A**

**Intended Use**  
Installation instructions

**Annex B12**



**Table C1: Characteristic values of resistance for threaded rod, HIT-V-... and AM 8.8 under tension loads in concrete**

HIT-HY 200-A with threaded rod, HIT-V-..., AM 8.8			M8	M10	M12	M16	M20	M24	M27	M30	
Installation safety factor	$\gamma_2$	[-]	1,0								
<b>Steel failure</b>											
Characteristic steel resistance	$N_{Rk,s}$	[kN]	$A_s \cdot f_{uk}$								
Partial safety factor grade 5.8	$\gamma_{Ms,N}^{1)}$	[-]	1,5								
Partial safety factor grade 8.8	$\gamma_{Ms,N}^{1)}$	[-]	1,5								
Partial safety factor HIT-V-R	$\gamma_{Ms,N}^{1)}$	[-]	1,86						2,86		
Partial safety factor HIT-V-HCR	$\gamma_{Ms,N}^{1)}$	[-]	1,5				2,1				
<b>Combined pullout and concrete cone failure</b>											
Characteristic bond resistance in non-cracked concrete C20/25											
Temperature range I: 40 °C/24 °C	$\tau_{Rk,ucr}$	[N/mm <sup>2</sup> ]	18								
Temperature range II: 80 °C/50 °C	$\tau_{Rk,ucr}$	[N/mm <sup>2</sup> ]	15								
Temperature range III: 120 °C/72 °C	$\tau_{Rk,ucr}$	[N/mm <sup>2</sup> ]	13								
Characteristic bond resistance in cracked concrete C20/25											
Temperature range I: 40 °C/24 °C	$\tau_{Rk,cr}$	[N/mm <sup>2</sup> ]	7,5	8,5				9,0			
Temperature range II: 80 °C/50 °C	$\tau_{Rk,cr}$	[N/mm <sup>2</sup> ]	6,0	7,0				7,5			
Temperature range III: 120 °C/72 °C	$\tau_{Rk,cr}$	[N/mm <sup>2</sup> ]	5,5	6,0				6,5			
Increasing factors for $\tau_{Rk}$ in concrete	$\psi_c$	C30/37	1,04								
		C40/45	1,07								
		C50/60	1,1								
<b>Splitting failure</b>											
Edge distance $c_{cr,sp}$ [mm] for	$h / h_{ef} \geq 2,0$		$1,0 \cdot h_{ef}$								
	$2,0 > h / h_{ef} > 1,3$		$4,6 h_{ef} - 1,8 h$								
	$h / h_{ef} \leq 1,3$		$2,26 h_{ef}$								
Spacing	$s_{cr,sp}$	[mm]	$2 \cdot c_{cr,sp}$								

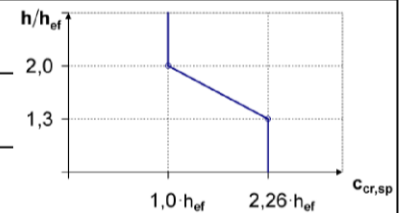

<sup>1)</sup> In absence of national regulations.

**Injection System Hilti HIT-HY 200-A**

**Performances**

Characteristic values of resistance under tension loads in concrete  
Design according to „EOTA Technical Report TR 029, Edition September 2010“

**Annex C1**

**Table C2: Characteristic values of resistance for threaded rod, HIT-V-... and AM 8.8 under shear loads**

HIT-HY 200-A with threaded rod, HIT-V-..., AM 8.8			M8	M10	M12	M16	M20	M24	M27	M30	
<b>Steel failure without lever arm</b>											
Characteristic steel resistance	$V_{Rk,s}$	[kN]	0,5 · $A_s$ · $f_{uk}$								
Partial safety factor grade 5.8	$\gamma_{Ms,V}^{1)}$	[-]	1,25								
Partial safety factor grade 8.8	$\gamma_{Ms,V}^{1)}$	[-]	1,25								
Partial safety factor HIT-V-R	$\gamma_{Ms,V}^{1)}$	[-]	1,56						2,38		
Partial safety factor HIT-V-HCR	$\gamma_{Ms,V}^{1)}$	[-]	1,25				1,75				
<b>Steel failure with lever arm</b>											
Characteristic bending moment	$M^0_{Rk,s}$	[Nm]	1,2 · $W_{el}$ · $f_{uk}$								
<b>Concrete pry-out failure</b>											
Factor in equation (5.7) of Technical Report TR 029 for the design of bonded anchors	k	[-]	2,0								
<b>Concrete edge failure</b>											
The value of $h_{ef}$ for calculation in equations (5.8a) and (5.8b) of Technical Report TR 029 is limited by:			min ( $h_{ef}$ ; 12 · $d_{nom}$ )								
Outside diameter of anchor	$d_{nom}$	[mm]	8	10	12	16	20	24	27	30	

<sup>1)</sup> In absence of national regulations.

**Injection System Hilti HIT-HY 200-A**

**Performances**

Characteristic values of resistance under shear loads in concrete  
Design according to „EOTA Technical Report TR 029, Edition September 2010“

**Annex C2**



**Table C3: Characteristic values of resistance for internally threaded sleeve HIS-(R)N under tension loads in concrete**

Hilti HIT-HY 200-A with HIS-(R)N			M8	M10	M12	M16	M20
Installation safety factor	$\gamma_2$	[-]	1,0				
<b>Steel failure threaded rods</b>							
Characteristic resistance HIS-N with screw grade 8.8	$N_{Rk,s}$	[kN]	25	46	67	125	116
Partial safety factor	$\gamma_{Ms,N}^{1)}$	[-]	1,50				
Characteristic resistance HIS-RN with screw grade 70	$N_{Rk,s}$	[kN]	26	41	59	110	166
Partial safety factor	$\gamma_{Ms,N}^{1)}$	[-]	1,87				
<b>Combined pull-out and Concrete cone failure</b>							
Effective anchorage depth	$h_{ef}$	[mm]	90	110	125	170	205
Effective anchor diameter	$d_1$	[mm]	12,5	16,5	20,5	25,4	27,6
Characteristic bond resistance in non-cracked concrete C20/25							
Temperature range I: 40 °C/24 °C	$\tau_{Rk,ucr}$	[N/mm <sup>2</sup> ]	13				
Temperature range II: 80 °C/50 °C	$\tau_{Rk,ucr}$	[N/mm <sup>2</sup> ]	11				
Temperature range III: 120 °C/72 °C	$\tau_{Rk,ucr}$	[N/mm <sup>2</sup> ]	9,5				
Characteristic bond resistance in cracked concrete C20/25							
Temperature range I: 40 °C/24 °C	$\tau_{Rk,cr}$	[N/mm <sup>2</sup> ]	7				
Temperature range II: 80 °C/50 °C	$\tau_{Rk,cr}$	[N/mm <sup>2</sup> ]	5,5				
Temperature range III: 120 °C/72 °C	$\tau_{Rk,cr}$	[N/mm <sup>2</sup> ]	5				
Increasing factor for $\tau_{Rk}$ in concrete	$\psi_c$	C30/37	1,04				
		C40/45	1,07				
		C50/60	1,1				
<b>Splitting failure relevant for non-cracked concrete</b>							
Edge distance $c_{cr,sp}$ [mm] for	$h / h_{ef} \geq 2,0$		$1,0 \cdot h_{ef}$				
	$2,0 > h / h_{ef} > 1,3$		$4,6 \cdot h_{ef} - 1,8 \cdot h$				
	$h / h_{ef} \leq 1,3$		$2,26 \cdot h_{ef}$				
Spacing	$s_{cr,sp}$	[mm]	$2 \cdot c_{cr,sp}$				

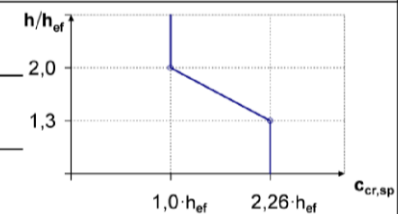

<sup>1)</sup> In absence of national regulations.

**Injection System Hilti HIT-HY 200-A**

**Performances**

Characteristic values of resistance under tension loads in concrete  
Design according to „EOTA Technical Report TR 029, Edition September 2010“

**Annex C3**

**Table C4: Characteristic values of resistance for internally threaded sleeve HIS-(R)N under shear loads in concrete**

Hilti HIT-HY 200-A with HIS-(R)N			M8	M10	M12	M16	M20
<b>Steel failure without lever arm</b>							
Characteristic resistance HIS-N with screw grade 8.8	$V_{Rk,s}$	[kN]	13	23	34	63	58
Partial safety factor	$\gamma_{Ms,V}^{1)}$	[-]	1,25				
Characteristic resistance HIS-RN with screw grade 70	$V_{Rk,s}$	[kN]	13	20	30	55	83
Partial safety factor	$\gamma_{Ms,V}^{1)}$	[-]	1,56				
<b>Steel failure with lever arm</b>							
Characteristic resistance HIS-N with screw grade 8.8	$M_{Rk,s}^o$	[Nm]	30	60	105	266	519
Partial safety factor	$\gamma_{Ms,V}^{1)}$	[-]	1,25				
Characteristic resistance HIS-RN with screw grade 70	$M_{Rk,s}^o$	[Nm]	26	52	92	233	454
Partial safety factor	$\gamma_{Ms,V}^{1)}$	[-]	1,56				
<b>Concrete pry-out failure</b>							
Factor in equation (5.7) of Technical Report TR 029 for the design of bonded anchors	k	[-]	2,0				
<b>Concrete edge failure</b>							
Outside diameter of anchor	$d_{nom}$	[mm]	12,5	16,5	20,5	25,4	27,6

<sup>1)</sup> In absence of national regulations.

**Injection System Hilti HIT-HY 200-A**

**Performances**

Characteristic values of resistance under shear loads in concrete  
Design according to „EOTA Technical Report TR 029, Edition September 2010“

**Annex C4**

**Table C5: Characteristic values of resistance for Hilti tension anchor HZA / HZA-R under tension loads in concrete**

Hilti HIT-HY 200-A with HZA, HZA-R			M12	M16	M20	M24	M27
Installation safety factor	$\gamma_2$	[-]	1,0				
<b>Steel failure</b>							
Characteristic resistance HZA	$N_{Rk,s}$	[kN]	46	86	135	194	253
Characteristic resistance HZA-R	$N_{Rk,s}$	[kN]	62	111	173	248	-
Partial safety factor	$\gamma_{Ms}^1$	[-]	1,4				
<b>Combined pull-out and concrete cone failure</b>							
Diameter of rebar	d	[mm]	12	16	20	25	28
Characteristic bond resistance in non-cracked concrete C20/25							
Temperature range I: 40 °C/24 °C	$\tau_{Rk,ucr}$	[N/mm <sup>2</sup> ]	12				
Temperature range II: 80 °C/50 °C	$\tau_{Rk,ucr}$	[N/mm <sup>2</sup> ]	10				
Temperature range III: 120 °C/72 °C	$\tau_{Rk,ucr}$	[N/mm <sup>2</sup> ]	8,5				
Characteristic bond resistance in cracked concrete C20/25							
Temperature range I: 40 °C/24 °C	$\tau_{Rk,cr}$	[N/mm <sup>2</sup> ]	7				
Temperature range II: 80 °C/50 °C	$\tau_{Rk,cr}$	[N/mm <sup>2</sup> ]	5,5				
Temperature range III: 120 °C/72 °C	$\tau_{Rk,cr}$	[N/mm <sup>2</sup> ]	5				
Increasing factor for $\tau_{Rk}$ in concrete	$\psi_c$	C30/37	1,04				
		C40/45	1,07				
		C50/60	1,1				
Effective anchorage depth for calculation of $N_{Rk,p}^0$ acc. Eq. 5.2a (TR 029, 5.2.2.3 Combined pull-out and concrete cone failure)	HZA	$h_{ef}$	[mm]	$h_{nom} - 20$			
	HZA-R	$h_{ef}$	[mm]	$h_{nom} - 100$			-
<b>Concrete cone failure</b>							
Effective anchorage depth for calculation of $N_{Rk,c}^0$ acc. Eq. 5.3a (TR 029, 5.2.2.4 Concrete cone failure)	HZA HZA-R	$h_{ef}$	[mm]	$h_{nom}$			
<b>Splitting failure relevant for non-cracked concrete</b>							
Edge distance $c_{cr,sp}$ [mm] for	$h / h_{ef} \geq 2,0$		$1,0 \cdot h_{ef}$				
	$2,0 > h / h_{ef} > 1,3$		$4,6 \cdot h_{ef} - 1,8 \cdot h$				
	$h / h_{ef} \leq 1,3$		$2,26 \cdot h_{ef}$				
Spacing	$s_{cr,sp}$	[mm]	$2 \cdot c_{cr,sp}$				

<sup>1)</sup> In absence of national regulations.

**Injection System Hilti HIT-HY 200-A**

**Performances**

Characteristic values of resistance under tension loads in concrete  
Design according to „EOTA Technical Report TR 029, Edition September 2010“

**Annex C5**

**Table C6: Characteristic values of resistance for Hilti tension anchor HZA, HZA-R under shear loads in concrete**

Hilti HIT-HY 200-A with HZA, HZA-R				M12	M16	M20	M24	M27
<b>Steel failure without lever arm</b>								
Characteristic resistance	HZA	$V_{Rk,s}$	[kN]	23	43	67	97	126
Characteristic resistance	HZA-R	$V_{Rk,s}$	[kN]	31	55	86	124	-
Partial safety factor		$\gamma_{Ms}^{1)}$	[-]	1,5				
<b>Steel failure with lever arm</b>								
Characteristic resistance	HZA	$M_{Rk,s}^0$	[Nm]	72	183	357	617	915
Characteristic resistance	HZA-R	$M_{Rk,s}^0$	[Nm]	97	234	457	790	-
Partial safety factor		$\gamma_{Ms}^{1)}$	[-]	1,5				
<b>Concrete pry-out failure</b>								
Factor in equation (5.7) of Technical Report TR 029 for the design of bonded anchors		k	[-]	2,0				
<b>Concrete edge failure</b>								
The value of $h_{ef}$ for calculation in equations (5.8a) and (5.8b) of Technical Report TR 029 is limited by:				min ( $h_{nom}$ ; $12 \cdot d_{nom}$ )				
Outside diameter of anchor		$d_{nom}$	[mm]	12	16	20	24	27

<sup>1)</sup> In absence of national regulations.

**Injection System Hilti HIT-HY 200-A**

**Performances**

Characteristic values of resistance under shear loads in concrete  
Design according to „EOTA Technical Report TR 029, Edition September 2010“

**Annex C6**

**Table C7: Characteristic values of resistance for rebar under tension loads in concrete**

HIT-HY 200-A with rebar		φ 8	φ 10	φ 12	φ 14	φ 16	φ 20	φ 25	φ 26	φ 28	φ 30	φ 32	
Installation safety factor	$\gamma_2$ [-]	1,0											
<b>Steel failure</b>													
Characteristic resistance for rebar B500B acc. to DIN 488:2009-08 <sup>2)</sup>	$N_{Rk,s}$ [kN]	28	43	62	85	111	173	270	292	339	388	442	
Partial safety factor <sup>3)</sup>	$\gamma_{Ms,N}$ <sup>1)</sup> [-]	1,4											
<b>Combined pull-out and Concrete cone failure</b>													
Diameter of rebar	d [mm]	8	10	12	14	16	20	25	26	28	30	32	
Characteristic bond resistance in non-cracked concrete C20/25													
Temperature range I: 40°C/24°C	$\tau_{Rk,ucr}$ [N/mm <sup>2</sup> ]	12											
Temperature range II: 80°C/50°C	$\tau_{Rk,ucr}$ [N/mm <sup>2</sup> ]	10											
Temperature range III: 120°C/72°C	$\tau_{Rk,ucr}$ [N/mm <sup>2</sup> ]	8,5											
Characteristic bond resistance in cracked concrete C20/25													
Temperature range I: 40°C/24°C	$\tau_{Rk,cr}$ [N/mm <sup>2</sup> ]	-	5						7				
Temperature range II: 80°C/50°C	$\tau_{Rk,cr}$ [N/mm <sup>2</sup> ]	-	4						5,5				
Temperature range III: 120°C/72°C	$\tau_{Rk,cr}$ [N/mm <sup>2</sup> ]	-	3,5						5				
Increasing factor for $\tau_{Rk}$ in concrete	$\psi_c$	C30/37					1,04						
		C40/45					1,07						
		C50/60					1,1						
<b>Splitting failure relevant for non-cracked concrete</b>													
Edge distance $c_{cr,sp}$ [mm] for	$h / h_{ef} \geq 2,0$	$1,0 \cdot h_{ef}$											
	$2,0 > h / h_{ef} > 1,3$	$4,6 \cdot h_{ef} - 1,8 \cdot h$											
	$h / h_{ef} \leq 1,3$	$2,26 \cdot h_{ef}$											
Spacing	$s_{cr,sp}$ [mm]	$2 c_{cr,sp}$											

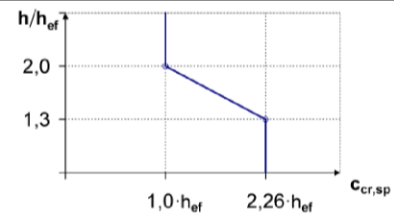

- 1) In absence of national regulations
- 2) The characteristic tension resistance  $N_{Rk,s}$  for rebars that do not fulfill the requirements acc. to DIN 488 shall be calculated acc. Technical Report TR 029, Equation (5.1).
- 3) The partial safety factor  $\gamma_{Ms,N}$  that do not fulfill the requirements acc. to DIN 488 shall be calculated acc. Technical Report TR 029, Equation (3.3a).

**Injection System Hilti HIT-HY 200-A**

**Performances**

Characteristic values of resistance under tension loads in concrete  
Design according to „EOTA Technical Report TR 029, Edition September 2010“

**Annex C7**

Table C8: Characteristic values of resistance for rebar under shear loads in concrete

HIT-HY 200-A with rebar	$\phi 8$	$\phi 10$	$\phi 12$	$\phi 14$	$\phi 16$	$\phi 20$	$\phi 25$	$\phi 26$	$\phi 28$	$\phi 30$	$\phi 32$
<b>Steel failure without lever arm</b>											
Characteristic resistance for rebar B500B acc. to DIN 488:2009-08 <sup>2)</sup> $V_{Rk,s}$ [kN]	14	22	31	42	55	86	135	146	169	194	221
Partial safety factor <sup>4)</sup> $\gamma_{Ms,V}$ <sup>1)</sup> [-]	1,5										
<b>Steel failure with lever arm</b>											
Characteristic resistance for rebar B500B acc. to DIN 488:2009-08 <sup>3)</sup> $M^o_{Rk,s}$ [Nm]	33	65	112	178	265	518	1012	1139	1422	1749	2123
<b>Concrete pry-out failure</b>											
Factor in equation (5.7) of Technical Report TR 029 for the design of bonded anchors k [-]	2,0										
<b>Concrete edge failure</b>											
The value of $h_{ef}$ for calculation in equations (5.8a) and (5.8b) of Technical Report TR 029 is limited by:	$\min(h_{ef}; 12 \cdot d_{nom})$										
Outside diameter of anchor $d_{nom}$ [mm]	8	10	12	14	16	20	25	26	28	30	32

<sup>1)</sup> In absence of national regulations.

<sup>2)</sup> The characteristic shear resistance  $V_{Rk,s}$  for rebars that do not fulfill the requirements acc. DIN 488 shall be calculated acc. Technical Report TR 029, Equation (5.5).

<sup>3)</sup> The characteristic bending resistance  $M^o_{Rk,s}$  for rebars that do not fulfil the requirements acc. DIN 488 shall be calculated acc. Technical Report TR 029, Equation (5.6b).

<sup>4)</sup> The partial safety factor  $\gamma_{Ms,V}$  for rebar that do not fulfill the requirements acc. to DIN 488 shall be calculated acc. Technical Report 029, Equation (3.3b) or (3.3c).

**Injection System Hilti HIT-HY 200-A**

**Performances**

Characteristic values of resistance under shear loads in concrete  
Design according to „EOTA Technical Report TR 029, Edition September 2010“

**Annex C8**

**Table C9: Displacements under tension load**

Hilti HIT-HY 200-A with threaded rod, HIT-V-..., AM 8.8		M8	M10	M12	M16	M20	M24	M27	M30	
Non-cracked concrete temperature range I : 40°C / 24°C										
Displacement	$\delta_{N0}$	[mm/(N/mm <sup>2</sup> )]	0,02	0,03	0,03	0,04	0,06	0,07	0,07	0,08
	$\delta_{N\infty}$	[mm/(N/mm <sup>2</sup> )]	0,04	0,05	0,06	0,08	0,10	0,13	0,14	0,16
Non-cracked concrete temperature range II : 80°C / 50°C										
Displacement	$\delta_{N0}$	[mm/(N/mm <sup>2</sup> )]	0,03	0,04	0,05	0,06	0,08	0,09	0,10	0,12
	$\delta_{N\infty}$	[mm/(N/mm <sup>2</sup> )]	0,04	0,05	0,06	0,09	0,11	0,13	0,15	0,16
Non-cracked concrete temperature range III : 120°C / 72°C										
Displacement	$\delta_{N0}$	[mm/(N/mm <sup>2</sup> )]	0,04	0,05	0,06	0,08	0,10	0,12	0,13	0,16
	$\delta_{N\infty}$	[mm/(N/mm <sup>2</sup> )]	0,04	0,05	0,07	0,09	0,11	0,13	0,15	0,17
Cracked concrete temperature range I : 40°C / 24°C										
Displacement	$\delta_{N0}$	[mm/(N/mm <sup>2</sup> )]	0,07							
	$\delta_{N\infty}$	[mm/(N/mm <sup>2</sup> )]	0,16							
Cracked concrete temperature range II : 80°C / 50°C										
Displacement	$\delta_{N0}$	[mm/(N/mm <sup>2</sup> )]	0,10							
	$\delta_{N\infty}$	[mm/(N/mm <sup>2</sup> )]	0,22							
Cracked concrete temperature range III : 120°C / 72°C										
Displacement	$\delta_{N0}$	[mm/(N/mm <sup>2</sup> )]	0,13							
	$\delta_{N\infty}$	[mm/(N/mm <sup>2</sup> )]	0,29							

**Table C10: Displacements under shear load**

Hilti HIT-HY 200-A with threaded rod, HIT-V-...		M8	M10	M12	M16	M20	M24	M27	M30	
Displacement	$\delta_{V0}$	[mm/kN]	0,06	0,06	0,05	0,04	0,04	0,03	0,03	0,03
	$\delta_{V\infty}$	[mm/kN]	0,09	0,08	0,08	0,06	0,06	0,05	0,05	0,05

**Injection System Hilti HIT-HY 200-A**

**Performances**  
Displacements with threaded rod, HIT-V-... and AM 8.8

**Annex C9**



**Table C11: Displacements under tension load**

Hilti HIT-HY 200-A with HIS-(R)N		M8	M10	M12	M16	M20
Non-cracked concrete temperature range I : 40°C / 24°C						
Displacement	$\delta_{N0}$ [mm/(N/mm <sup>2</sup> )]	0,03	0,05	0,06	0,07	0,08
	$\delta_{N\infty}$ [mm/(N/mm <sup>2</sup> )]	0,06	0,09	0,11	0,13	0,14
Non-cracked concrete temperature range II : 80°C / 50°C						
Displacement	$\delta_{N0}$ [mm/(N/mm <sup>2</sup> )]	0,05	0,06	0,08	0,10	0,11
	$\delta_{N\infty}$ [mm/(N/mm <sup>2</sup> )]	0,07	0,09	0,11	0,13	0,15
Non-cracked concrete temperature range III : 120°C / 72°C						
Displacement	$\delta_{N0}$ [mm/(N/mm <sup>2</sup> )]	0,06	0,08	0,10	0,13	0,14
	$\delta_{N\infty}$ [mm/(N/mm <sup>2</sup> )]	0,07	0,09	0,11	0,14	0,15
Cracked concrete temperature range I : 40°C / 24°C						
Displacement	$\delta_{N0}$ [mm/(N/mm <sup>2</sup> )]					0,11
	$\delta_{N\infty}$ [mm/(N/mm <sup>2</sup> )]					0,16
Cracked concrete temperature range II : 80°C / 50°C						
Displacement	$\delta_{N0}$ [mm/(N/mm <sup>2</sup> )]					0,15
	$\delta_{N\infty}$ [mm/(N/mm <sup>2</sup> )]					0,22
Cracked concrete temperature range III : 120°C / 72°C						
Displacement	$\delta_{N0}$ [mm/(N/mm <sup>2</sup> )]					0,20
	$\delta_{N\infty}$ [mm/(N/mm <sup>2</sup> )]					0,29

**Table C12: Displacements under shear load**

Hilti HIT-HY 200-A with HIS-(R)N		M8	M10	M12	M16	M20
Displacement	$\delta_{V0}$ [mm/kN]	0,06	0,06	0,05	0,04	0,04
	$\delta_{V\infty}$ [mm/kN]	0,09	0,08	0,08	0,06	0,06

**Injection System Hilti HIT-HY 200-A**

**Performances**  
Displacements with HIS-(R)N

**Annex C10**



**Table C13: Displacements under tension load**

Hilti HIT-HY 200-A with HZA, HZA-R			M12	M16	M20	M24	M27
Non-cracked concrete temperature range I : 40°C / 24°C							
Displacement	$\delta_{N0}$	[mm/(N/mm <sup>2</sup> )]	0,03	0,04	0,06	0,07	0,08
	$\delta_{N\infty}$	[mm/(N/mm <sup>2</sup> )]	0,06	0,08	0,13	0,13	0,15
Non-cracked concrete temperature range II : 80°C / 50°C							
Displacement	$\delta_{N0}$	[mm/(N/mm <sup>2</sup> )]	0,05	0,06	0,08	0,10	0,11
	$\delta_{N\infty}$	[mm/(N/mm <sup>2</sup> )]	0,06	0,09	0,14	0,14	0,15
Non-cracked concrete temperature range III : 120°C / 72°C							
Displacement	$\delta_{N0}$	[mm/(N/mm <sup>2</sup> )]	0,06	0,08	0,10	0,12	0,14
	$\delta_{N\infty}$	[mm/(N/mm <sup>2</sup> )]	0,07	0,09	0,14	0,14	0,16
Cracked concrete temperature range I : 40°C / 24°C							
Displacement	$\delta_{N0}$	[mm/(N/mm <sup>2</sup> )]	0,11				
	$\delta_{N\infty}$	[mm/(N/mm <sup>2</sup> )]	0,16				
Cracked concrete temperature range II : 80°C / 50°C							
Displacement	$\delta_{N0}$	[mm/(N/mm <sup>2</sup> )]	0,15				
	$\delta_{N\infty}$	[mm/(N/mm <sup>2</sup> )]	0,22				
Cracked concrete temperature range III : 120°C / 72°C							
Displacement	$\delta_{N0}$	[mm/(N/mm <sup>2</sup> )]	0,20				
	$\delta_{N\infty}$	[mm/(N/mm <sup>2</sup> )]	0,29				

**Table C14: Displacements under shear load**

Hilti HIT-HY 200-A with HZA, HZA-R			M12	M16	M20	M24	M27
Displacement	$\delta_{V0}$	[mm/kN]	0,05	0,04	0,04	0,03	0,03
	$\delta_{V\infty}$	[mm/kN]	0,08	0,06	0,06	0,05	0,05

**Injection System Hilti HIT-HY 200-A**

**Performances**  
Displacements with HZA and HZA-R

**Annex C11**

**Table C15: Displacements under tension load**

Hilti HIT-HY 200-A with rebar	Ø 8	Ø 10	Ø 12	Ø 14	Ø 16	Ø 20	Ø 25	Ø 26	Ø 28	Ø 30	Ø 32		
Non-cracked concrete temperature range I : 40°C / 24°C													
Displacement	$\delta_{N0}$ [mm/(N/mm <sup>2</sup> )]	0,02	0,03	0,03	0,04	0,04	0,06	0,07	0,08	0,08	0,09	0,09	
	$\delta_{N\infty}$ [mm/(N/mm <sup>2</sup> )]	0,04	0,05	0,06	0,07	0,08	0,10	0,13	0,14	0,15	0,16	0,17	
Non-cracked concrete temperature range II : 80°C / 50°C													
Displacement	$\delta_{N0}$ [mm/(N/mm <sup>2</sup> )]	0,03	0,04	0,05	0,05	0,06	0,08	0,10	0,11	0,11	0,12	0,12	
	$\delta_{N\infty}$ [mm/(N/mm <sup>2</sup> )]	0,04	0,05	0,06	0,07	0,09	0,11	0,14	0,15	0,15	0,16	0,17	
Non-cracked concrete temperature range III : 120°C / 72°C													
Displacement	$\delta_{N0}$ [mm/(N/mm <sup>2</sup> )]	0,04	0,05	0,06	0,07	0,08	0,10	0,12	0,13	0,14	0,15	0,16	
	$\delta_{N\infty}$ [mm/(N/mm <sup>2</sup> )]	0,04	0,05	0,07	0,08	0,09	0,11	0,14	0,15	0,16	0,17	0,18	
Cracked concrete temperature range I : 40°C / 24°C													
Displacement	$\delta_{N0}$ [mm/(N/mm <sup>2</sup> )]						0,11						
	$\delta_{N\infty}$ [mm/(N/mm <sup>2</sup> )]						0,16						
Cracked concrete temperature range II : 80°C / 50°C													
Displacement	$\delta_{N0}$ [mm/(N/mm <sup>2</sup> )]						0,15						
	$\delta_{N\infty}$ [mm/(N/mm <sup>2</sup> )]						0,22						
Cracked concrete temperature range III : 120°C / 72°C													
Displacement	$\delta_{N0}$ [mm/(N/mm <sup>2</sup> )]						0,20						
	$\delta_{N\infty}$ [mm/(N/mm <sup>2</sup> )]						0,29						

**Table C16: Displacements under shear load**

Hilti HIT-HY 200-A with rebar	Ø 8	Ø 10	Ø 12	Ø 14	Ø 16	Ø 20	Ø 25	Ø 26	Ø 28	Ø 30	Ø 32
Displacement	$\delta_{V0}$ [mm/kN]	0,06	0,05	0,05	0,04	0,04	0,04	0,03	0,03	0,03	0,03
	$\delta_{V\infty}$ [mm/kN]	0,09	0,08	0,07	0,06	0,06	0,05	0,05	0,05	0,04	0,04

**Injection System Hilti HIT-HY 200-A**

**Performances**  
Displacements with rebar

**Annex C12**

**Seismic design shall be carried out according to the TR 045 „Design of Metal Anchors Under Seismic Action“**

**Table C17: Characteristic values of resistance for threaded rod, HIT-V-... -..., AM 8.8 under tension loads for seismic performance category C1**

HIT-HY 200-A with threaded rod, HIT-V-..., AM 8.8				M8	M10	M12	M16	M20	M24	M27	M30
<b>Steel failure</b>											
HIT-V-5.8(F), threaded rod 5.8	$N_{Rk,s,seis}$	[kN]	-	29	42	79	123	177	230	281	
HIT-V-8.8(F), threaded rod 8.8	$N_{Rk,s,seis}$	[kN]	-	46	67	126	196	282	367	449	
HIT-V-R, threaded rod A4-70	$N_{Rk,s,seis}$	[kN]	-	41	59	110	172	247	230	281	
HIT-V-HCR, threaded rod HCR-80	$N_{Rk,s,seis}$	[kN]	-	46	67	126	196	247	321	393	
<b>Combined pullout and concrete cone failure</b>											
Characteristic bond resistance in cracked concrete C20/25											
Temperature range I: 40 °C/24 °C	$\tau_{Rk,s,seis}$	[N/mm <sup>2</sup> ]	-	5,2				7,0			
Temperature range II: 80 °C/50 °C	$\tau_{Rk,s,seis}$	[N/mm <sup>2</sup> ]	-	3,9				5,7			
Temperature range III: 120 °C/72 °C	$\tau_{Rk,s,seis}$	[N/mm <sup>2</sup> ]	-	3,5				4,8			

**Table C18: Characteristic values of resistance for threaded rod, HIT-V-... and AM 8.8 under shear loads for seismic performance category C1**

HIT-HY 200-A with threaded rod, HIT-V-..., AM 8.8				M8	M10	M12	M16	M20	M24	M27	M30
<b>Steel failure without lever arm</b>											
HIT-V 5.8(F), threaded rod 5.8	$V_{Rk,s,seis}$	[kN]	-	11	15	27	43	62	81	98	
HIT-V 8.8(F), threaded rod 8.8	$V_{Rk,s,seis}$	[kN]	-	16	24	44	69	99	129	157	
HIT-V R, threaded rod A4-70	$V_{Rk,s,seis}$	[kN]	-	14	21	39	60	87	81	98	
HIT-V HCR, threaded rod HCR-80	$V_{Rk,s,seis}$	[kN]	-	16	24	44	69	87	113	137	

**Table C19: Displacements under tension load for seismic performance category C1**

HIT-HY 200-A with threaded rod, HIT-V-..., AM 8.8				M8	M10	M12	M16	M20	M24	M27	M30
Displacement <sup>1)</sup>	$\delta_{N,seis}$	[mm]	-	0,8	0,8	0,8	0,8	0,8	0,8	0,8	0,8

<sup>1)</sup> Maximum displacement during cycling (seismic event).

**Table C20: Displacements under shear load for seismic performance category C1**

HIT-HY 200-A with threaded rod, HIT-V-..., AM 8.8				M8	M10	M12	M16	M20	M24	M27	M30
Displacement <sup>1)</sup>	$\delta_{V,seis}$	[mm]	-	3,5	3,8	4,4	5,0	5,6	6,1	6,5	

<sup>1)</sup> Maximum displacement during cycling (seismic event).

**Injection System Hilti HIT-HY 200-A**

**Performances**

Characteristic values for seismic performance category C1 and displacements  
Design according to „EOTA Technical Report TR045, Edition February 2013 “

**Annex C13**

**Table C21: Characteristic values of resistance for Hilti tension anchor HZA, HZA-R under tension loads for seismic performance category C1**

HIT-HY 200-A with Hilti tension anchor HZA, HZA-R			M12	M16	M20	M24	M27
<b>Steel failure</b>							
Characteristic resistance HZA	$N_{Rk,s,seis}$	[kN]	46	86	135	194	253
Characteristic resistance HZA-R	$N_{Rk,s,seis}$	[kN]	62	111	173	248	-
Partial safety factor	$\gamma_{Ms,N,seis}$ <sup>1)</sup>	[-]	1,4				
<b>Combined pull-out and concrete cone failure<sup>1)</sup></b>							
Diameter of rebar	d	[mm]	12	16	20	25	28
Characteristic bond resistance in cracked concrete C20/25							
Temperature range I:	40°C/24°C	$\tau_{Rk,cr}$	[N/mm <sup>2</sup> ]		6,1		
Temperature range II:	80°C/50°C	$\tau_{Rk,cr}$	[N/mm <sup>2</sup> ]		4,8		
Temperature range III:	120°C/72°C	$\tau_{Rk,cr}$	[N/mm <sup>2</sup> ]		4,4		

<sup>1)</sup> In absence of national regulations.

**Table C22: Characteristic values of resistance for Hilti tension anchor HZA, HZA-R under shear loads for seismic performance category C1**

HIT-HY 200-A with Hilti tension anchor HZA, HZA-R			M12	M16	M20	M24	M27
<b>Steel failure without lever arm</b>							
Characteristic resistance HZA	$V_{Rk,s,seis}$	[kN]	16	30	47	68	88
Characteristic resistance HZA-R	$V_{Rk,s,seis}$	[kN]	22	39	60	124	-
Partial safety factor	$\gamma_{Ms,V,seis}$ <sup>1)</sup>	[-]	1,5				

<sup>1)</sup> In absence of national regulations.

**Table C23: Displacements under tension load for seismic performance category C1**

HIT-HY 200-A with Hilti tension anchor HZA, HZA-R			M12	M16	M20	M24	M27
Displacement <sup>1)</sup>	$\delta_{N,seis}$	[mm]	1,3	1,3	1,3	1,3	1,3

<sup>1)</sup> Maximum displacement during cycling (seismic event).

**Table C24: Displacements under shear load for seismic performance category C1**

HIT-HY 200-A with Hilti tension anchor HZA, HZA-R			M12	M16	M20	M24	M27
Displacement <sup>1)</sup>	$\delta_{V,seis}$	[mm]	3,8	4,4	5,0	5,6	6,1

<sup>1)</sup> Maximum displacement during cycling (seismic event).

**Injection System Hilti HIT-HY 200-A**

**Performances**

Characteristic values for seismic performance category C1 and displacements  
Design according to „EOTA Technical Report TR 045, Edition February 2013“

**Annex C14**

**Table C25: Characteristic values of resistance for rebar under tension loads for seismic performance category C1**

HIT-HY 200-A with rebar	φ 8	φ 10	φ 12	φ 14	φ 16	φ 20	φ 25	φ 26	φ 28	φ 30	φ 32
<b>Steel failure</b>											
Characteristic resistance for rebar B500B acc. to DIN 488:2009-08 <sup>1)</sup> $N_{Rk,seis}$ [kN]	-	43	62	85	111	173	270	292	339	388	442
<b>Combined pull-out and Concrete cone failure</b>											
Diameter of rebar d [mm]	-	10	12	14	16	20	25	26	28	30	32
Characteristic bond resistance in cracked concrete C20/25											
Temperature range I: 40°C/24°C $\tau_{Rk,cr}$ [N/mm <sup>2</sup> ]	-	4,4	6,1								
Temperature range II: 80°C/50°C $\tau_{Rk,cr}$ [N/mm <sup>2</sup> ]	-	3,5	4,8								
Temperature range III: 120°C/72°C $\tau_{Rk,cr}$ [N/mm <sup>2</sup> ]	-	3	4,4								

<sup>1)</sup> The characteristic tension resistance  $N_{Rk,s,seis}$  for rebars that do not fulfil the requirements acc. DIN 488 shall be calculated acc. Technical Report TR 029, Equation (5.1),  $N_{Rk,s,seis} = N_{Rk,s}$ .

**Table C26: Characteristic values of resistance for rebar under shear loads for seismic performance category C1**

HIT-HY 200-A with rebar	φ 8	φ 10	φ 12	φ 14	φ 16	φ 20	φ 25	φ 26	φ 28	φ 30	φ 32
<b>Steel failure without lever arm</b>											
Characteristic resistance for rebar B500B acc. to DIN 488:2009-08 $V_{Rk,s,seis}$ [kN]	-	15	22	29	39	60	95	102	118	135	165

<sup>1)</sup> The characteristic shear resistance  $V_{Rk,s,seis}$  for rebars that do not fulfil the requirements acc. DIN 488 shall be calculated acc. Technical Report TR 029, Equation (5.5),  $V_{Rk,s,seis} = 0,7 \times V_{Rk,s}$ .

**Table C27: Displacements under tension load for seismic performance category C1**

Hilti HIT-HY 200-A with rebar	φ 8	φ 10	φ 12	φ 14	φ 16	φ 20	φ 25	φ 26	φ 28	φ 30	φ 32
Displacement <sup>1)</sup> $\delta_{N,seis}$ [mm]	-	1,3	1,3	1,3	1,3	1,3	1,3	1,3	1,3	1,3	1,3

<sup>1)</sup> Maximum displacement during cycling (seismic event).

**Table C28: Displacements under shear load for seismic performance category C1**

Hilti HIT-HY 200-A with rebar	φ 8	φ 10	φ 12	φ 14	φ 16	φ 20	φ 25	φ 26	φ 28	φ 30	φ 32
Displacement <sup>1)</sup> $\delta_{V,seis}$ [mm]	-	3,5	3,8	4,1	4,4	5,0	5,8	6,2	6,2	6,8	6,8

<sup>1)</sup> Maximum displacement during cycling (seismic event).

**Injection System Hilti HIT-HY 200-A**

**Performances**

Characteristic values for seismic performance category C1 and displacements Design according to „EOTA Technical Report TR 045, Edition February 2013“

**Annex C15**



**Tabelle C29: Charakteristische Werte der Zugtragfähigkeit für Gewindestangen, HIT-V-... und AM 8.8 bei Erdbebenbeanspruchung, Leistungskategorie C2**

HIT-HY 200-A mit Gewindestange, HIT-V-..., AM 8.8	M8	M10	M12	M16	M20	M24	M27	M30
<b>Stahlversagen</b>								
HIT-V (-F) 8.8, AM (HDG) 8.8 Handelsübliche Gewindestange 8.8 nur galvanisch verzinkt	$N_{Rk,s,seis}$ [kN]			-	126	196	282	-
<b>Kombiniertes Versagen durch Herausziehen und Betonausbruch</b>								
Charakteristische Verbundtragfähigkeit in gerissenem Beton C20/25, in hammergebohrten Bohrlöchern (TE-CD und TE-YD)								
Temperaturbereich I: 40 °C/24 °C	$\tau_{Rk,seis}$ [N/mm <sup>2</sup> ]	-	3,9	4,3	3,5	-		
Temperaturbereich II: 80 °C/50 °C	$\tau_{Rk,seis}$ [N/mm <sup>2</sup> ]	-	3,3	3,7	2,9	-		
Temperaturbereich III: 120 °C/72 °C	$\tau_{Rk,seis}$ [N/mm <sup>2</sup> ]	-	2,8	3,2	2,5	-		

**Tabelle C30: Charakteristische Werte der Quertragfähigkeit für Gewindestangen, HIT-V-... und AM 8.8 bei Erdbebenbeanspruchung, Leistungskategorie C2**

HIT-HY 200-A mit Gewindestange, HIT-V-..., AM 8.8	M8	M10	M12	M16	M20	M24	M27	M30
<b>Stahlversagen ohne Hebelarm, Montage mit Hilti Verfüll-Set</b>								
HIT-V 8.8, AM 8.8	$V_{Rk,s,seis}$ [kN]			-	46	77	103	-
<b>Stahlversagen ohne Hebelarm, Montage ohne Hilti Verfüll-Set</b>								
HIT-V 8.8, AM 8.8	$V_{Rk,s,seis}$ [kN]			-	40	71	90	-
HIT-V-F 8.8, AM HDG 8.8	$V_{Rk,s,seis}$ [kN]			-	30	46	66	-
Handelsübliche Gewindestange 8.8 galvanisch verzinkt	$V_{Rk,s,seis}$ [kN]			-	28	50	63	-

**Injektionssystem Hilti HIT-HY 200-A**

**Leistungsfähigkeit**

Charakteristische Werte bei Erdbebenbeanspruchung, Leistungskat. C2  
Bemessung nach „EOTA Technical Report TR045, Edition Februar 2013“

**Anhang C16**

**Table C31: Displacements under tension load for seismic performance category C2**

HIT-HY 200-A with threaded rod, HIT-V-..., AM 8.8	M8	M10	M12	M16	M20	M24	M27	M30
Displacement DLS, HIT-V (-F) 8.8, AM (HDG) 8.8 $\delta_{N,seis(DLS)}$ [mm]	-			0,2	0,5	0,4	-	
Displacement ULS, HIT-V (-F) 8.8, AM (HDG) 8.8 $\delta_{N,seis(ULS)}$ [mm]	-			0,6	0,8	1,0	-	

**Table C32: Displacements under shear load for seismic performance category C2**

HIT-HY 200-A with threaded rod, HIT-V-..., AM 8.8	M8	M10	M12	M16	M20	M24	M27	M30
<b>Installation with Hilti Filling Set</b>								
Displacement DLS, HIT-V 8.8, AM 8.8 $\delta_{V,seis(DLS)}$ [mm]	-			1,2	1,4	1,1	-	
Displacement ULS, HIT-V 8.8, AM 8.8 $\delta_{V,seis(ULS)}$ [mm]	-			3,2	3,8	2,6	-	
<b>Installation without Hilti Filling Set</b>								
Displacement DLS, HIT-V 8.8, AM 8.8 $\delta_{V,seis(DLS)}$ [mm]	-			3,2	2,5	3,5	-	
Displacement DLS, HIT-V-F 8.8, AM HDG 8.8 $\delta_{V,seis(DLS)}$ [mm]	-			2,3	3,8	3,7	-	
Displacement ULS, HIT-V, 8.8 AM 8.8 $\delta_{V,seis(ULS)}$ [mm]	-			9,2	7,1	10,2	-	
Displacement ULS, HIT-V-F 8.8, AM HDG 8.8 $\delta_{V,seis(ULS)}$ [mm]	-			4,3	9,1	8,4	-	

**Injection System Hilti HIT-HY 200-A**

**Performances**

Displacements for seismic performance category C2  
Design according to „EOTA Technical Report TR 045, Edition February 2013“

**Annex C17**