



HUD-L Universal anchor

	Anchor version	Benefits
	HUD-L 6 HUD-L 8	<ul style="list-style-type: none"> - universal plastic anchor for weak base materials and renovation - for many base materials - daily application - excellent setting behaviour
	HUD-L 10	



Concrete

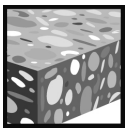
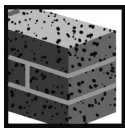

Solid brick

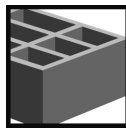

Hollow brick

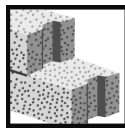

Autoclaved aerated concrete

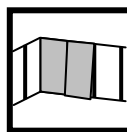

Drywall

Basic loading data (for a single anchor)

All data in this section applies to

- Correct setting (See setting instruction)
- Load data are only valid for the specified woodscrew type
- Load data given in the tables is independent of load direction
- No edge distance and spacing influence
- Base material as specified in the table
- Minimum base material thickness

Characteristic resistance

Anchor size		HUD-L 6x50	HUD-L 8x60	HUD-L 10x70
	Screw type ^{o)}	Woodscrew 4,5x80 DIN 96	Woodscrew 5x90 DIN 96	Woodscrew 8mm DIN 571
Concrete ≥ C16/20	F _{Rk} [kN]	1,15	1,4	9,0
Solid clay brick Mz 12	F _{Rk} [kN]	0,85	1,0	-
Solid clay brick Mz 20	F _{Rk} [kN]	-	-	7,0
Solid sand-lime brick KS 12	F _{Rk} [kN]	0,85	1,0	2
Hollow clay brick Hlz 12 ^{a)}	F _{Rk} [kN]	0,5	0,75	1,5
Hollow sand-lime brick KSL 12	F _{Rk} [kN]	0,7	0,8	-
Autoclaved aerated concrete AAC 2 ^{a)}	F _{Rk} [kN]	0,25	0,55	2,0
Gypsum board Thickness 2x12,5mm ^{a)}	F _{Rk} [kN]	0,3	0,7	0,6 ^{b)}

a) Drilling without hammering

b) Suitable for fitting hexagonal screws by hand

c) Load data are valid for the mentioned woodscrew type, if other types or different screws are used the load capacity may decrease.

Design resistance

Anchor size		HUD-L 6x50	HUD-L 8x60	HUD-L 10x70
	Screw type ^{c)}	Woodscrew 4,5x80 DIN 96	Woodscrew 5x90 DIN 96	Woodscrew 8mm DIN 571
Concrete ≥ C16/20	F _{Rd} [kN]	0,32	0,39	2,52
Solid clay brick Mz 12	F _{Rd} [kN]	0,24	0,28	-
Solid clay brick Mz 20	F _{Rd} [kN]	-	-	1,96
Solid sand-lime brick KS 12	F _{Rd} [kN]	0,24	0,28	0,56
Hollow clay brick Hz 12 ^{a)}	F _{Rd} [kN]	0,14	0,21	0,42
Hollow sand-lime brick KSL 12	F _{Rd} [kN]	0,20	0,22	-
Autoclaved aerated concrete AAC 2 ^{a)}	F _{Rd} [kN]	0,07	0,15	0,56
Gypsum board Thickness 2x12,5mm ^{a)}	F _{Rd} [kN]	0,08	0,20	0,17 ^{b)}

a) Drilling without hammering

b) Suitable for fitting hexagonal screws by hand

c) Load data are valid for the mentioned woodscrew type, if other types or different screws are used the load capacity may decrease.

Recommended loads ^{d)}

Anchor size		HUD-L 6x50	HUD-L 8x60	HUD-L 10x70
	Screw type ^{c)}	Woodscrew 4,5x80 DIN 96	Woodscrew 5x90 DIN 96	Woodscrew 8mm DIN 571
Concrete ≥ C16/20	F _{rec} [kN]	0,23	0,28	1,8
Solid clay brick Mz 12	F _{rec} [kN]	0,17	0,2	-
Solid clay brick Mz 20	F _{rec} [kN]	-	-	1,4
Solid sand-lime brick KS 12	F _{rec} [kN]	0,17	0,2	0,4
Hollow clay brick Hz 12 ^{a)}	F _{rec} [kN]	0,1	0,15	0,3
Hollow sand-lime brick KSL 12	F _{rec} [kN]	0,14	0,16	-
Autoclaved aerated concrete AAC 2 ^{a)}	F _{rec} [kN]	0,05	0,11	0,4
Gypsum board Thickness 2x12,5mm ^{a)}	F _{rec} [kN]	0,06	0,14	0,12 ^{b)}

a) Drilling without hammering

b) Suitable for fitting hexagonal screws by hand

c) Load data are valid for the mentioned woodscrew type, if other types or different screws are used the load capacity may decrease.

d) With overall global safety factor $\gamma = 5$ to the characteristic loads and a partial safety factor of $\gamma = 1,4$ to the design values.

Service temperature range

Hilti HUD-L universal anchor may be applied in the temperature range given below.

Temperature range	Base material temperature	Maximum long term base material temperature	Maximum short term base material temperature
Temperature range	-40 °C to +80 °C	+50 °C	+80 °C

Max short term base material temperature

Short-term elevated base material temperatures are those that occur over brief intervals, e.g. as a result of diurnal cycling.

Max long term base material temperature

Long-term elevated base material temperatures are roughly constant over significant periods of time.

Materials

Material quality

Part	Material
Plastic sleeve	Polyamide 6

Setting

Installation equipment

Anchor size	HUD-L 6x50	HUD-L 8x60	HUD-L 10x70
Rotary hammer	TE 2 – TE 16		
Other tools	Screwdriver		

Setting instruction

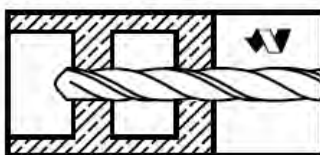

Drill hole with drill bit.

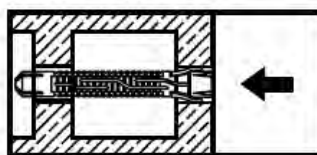

Install anchor.

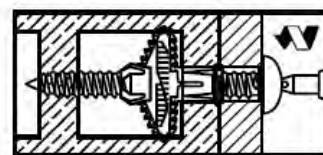

Put part being fastened in place and drive screw into anchor.

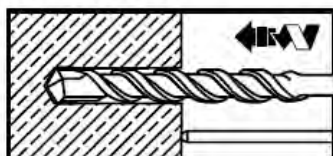

Drill hole with drill bit.

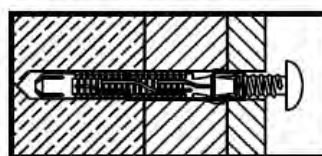

Put part being fastened in place and install anchor.

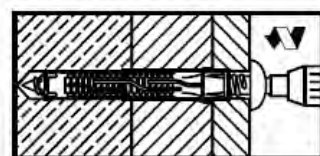

Drive screw into anchor.

Use only for wall and floor applications. Not applicable for ceiling and façade applications.

For detailed information on installation see instruction for use given with the package of the product.

Setting details: depth of drill hole h_1 and effective anchorage depth h_{ef}

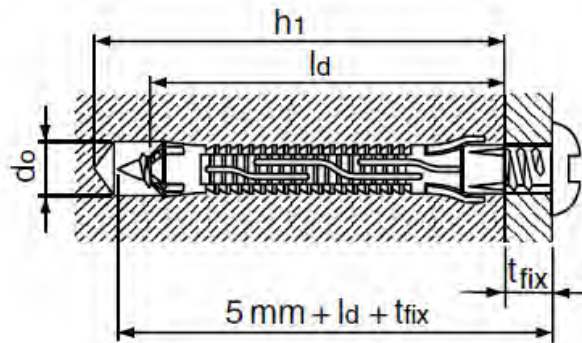

Setting details HUD-L

Anchor version HUD-L		HUD-L 6x50	HUD-L 8x60	HUD-L 10x70
Nominal diameter of drill bit	d_o [mm]	6	8	10
Cutting diameter of drill bit	$d_{cut} \leq$ [mm]	6,4	8,45	10,45
Depth of drill hole	$h_1 \geq$ [mm]	70	80	90
Effective anchorage depth	h_{nom} [mm]	47	57	70
Anchor length	l [mm]	47	57	70
Max fixture thickness	t_{fix} [mm]	Depending on screw length		
Installation temperature	[°C]	-10 to +40		
Recommended length of screw in base material	l_d [mm]	55	65	75
Woodscrew diameter ^{a)}	d [mm]	4,5 - 5	5 - 6	7 - 8

a) The basic loading data are depending on the woodscrew diameters, if other types or different screws are used the load capacity may decrease. Highlighted diameters refer to basic loading data table.