



## European Technical Approval ETA-11/0190

English translation prepared by DIBt - Original version in German language

Handelsbezeichnung  
*Trade name*

Würth Schrauben  
*Würth self-tapping screws*

Zulassungsinhaber  
*Holder of approval*

Adolf Würth GmbH & Co. KG  
Reinhold-Würth-Straße 12-17  
74653 Künzelsau  
DEUTSCHLAND

Zulassungsgegenstand  
und Verwendungszweck  
*Generic type and use  
of construction product*

Selbstbohrende Schrauben als Holzverbindungsmittel  
*Self-tapping screws for use in timber constructions*

Geltungsdauer:  
*Validity:* vom  
*from*  
bis  
*to*

27 June 2013  
27 June 2018

Herstellwerk  
*Manufacturing plant*

Werk 1, Werk 2, Werk 3, Werk 4, Werk 5, Werk 6, Werk 7, Werk 8,  
Werk 9, Werk 10, Werk 11, Werk 12

Diese Zulassung umfasst  
*This Approval contains*

99 Seiten einschließlich 6 Anhänge  
*99 pages including 6 annexes*

Diese Zulassung ersetzt  
*This Approval replaces*

ETA-11/0190 mit Geltungsdauer vom 03.06.2013 bis 05.09.2016  
*ETA-11/0190 with validity from 03.06.2013 to 05.09.2016*

## I LEGAL BASES AND GENERAL CONDITIONS

- 1 This European technical approval is issued by Deutsches Institut für Bautechnik in accordance with:
  - Council Directive 89/106/EEC of 21 December 1988 on the approximation of laws, regulations and administrative provisions of Member States relating to construction products<sup>1</sup>, modified by Council Directive 93/68/EEC<sup>2</sup> and Regulation (EC) N° 1882/2003 of the European Parliament and of the Council<sup>3</sup>;
  - *Gesetz über das In-Verkehr-Bringen von und den freien Warenverkehr mit Bauprodukten zur Umsetzung der Richtlinie 89/106/EWG des Rates vom 21. Dezember 1988 zur Angleichung der Rechts- und Verwaltungsvorschriften der Mitgliedstaaten über Bauprodukte und anderer Rechtsakte der Europäischen Gemeinschaften (Bauproduktengesetz - BauPG) vom 28. April 1998<sup>4</sup>, as amended by Article 2 of the law of 8 November 2011<sup>5</sup>;*
  - Common Procedural Rules for Requesting, Preparing and the Granting of European technical approvals set out in the Annex to Commission Decision 94/23/EC<sup>6</sup>.
- 2 Deutsches Institut für Bautechnik is authorized to check whether the provisions of this European technical approval are met. Checking may take place in the manufacturing plant. Nevertheless, the responsibility for the conformity of the products to the European technical approval and for their fitness for the intended use remains with the holder of the European technical approval.
- 3 This European technical approval is not to be transferred to manufacturers or agents of manufacturers other than those indicated on page 1, or manufacturing plants other than those indicated on page 1 of this European technical approval.
- 4 This European technical approval may be withdrawn by Deutsches Institut für Bautechnik, in particular pursuant to information by the Commission according to Article 5(1) of Council Directive 89/106/EEC.
- 5 Reproduction of this European technical approval including transmission by electronic means shall be in full. However, partial reproduction can be made with the written consent of Deutsches Institut für Bautechnik. In this case partial reproduction has to be designated as such. Texts and drawings of advertising brochures shall not contradict or misuse the European technical approval.
- 6 The European technical approval is issued by the approval body in its official language. This version corresponds fully to the version circulated within EOTA. Translations into other languages have to be designated as such.

<sup>1</sup> Official Journal of the European Communities L 40, 11 February 1989, p. 12  
<sup>2</sup> Official Journal of the European Communities L 220, 30 August 1993, p. 1  
<sup>3</sup> Official Journal of the European Union L 284, 31 October 2003, p. 25  
<sup>4</sup> *Bundesgesetzblatt Teil I 1998*, p. 812  
<sup>5</sup> *Bundesgesetzblatt Teil I 2011*, p. 2178  
<sup>6</sup> Official Journal of the European Communities L 17, 20 January 1994, p. 34

## II SPECIFIC CONDITIONS OF THE EUROPEAN TECHNICAL APPROVAL

### 1 Definition of product and intended use

#### 1.1 Definition of the construction product

Würth "ASSY", "ASSY-ISOTOP", "ASSY plus" and "ASSY plus VG" screws are self-tapping screws made from special carbon or stainless steel. Screws made from carbon steel are hardened, except "ASSY-ISOTOP" screws. They are anti-friction coated and they have a corrosion protection according to Annex A.1.6. The outer thread diameter  $d$  is not less than 3.0 mm and not greater than 14.0 mm. The overall length of the screws is ranging from 18 mm to 2000 mm. Further dimensions are shown in Annex 6. The washers are made from carbon or stainless steel or aluminium. The dimensions of the washers are given in Annex 6.

#### 1.2 Intended use

The screws are intended to be used for connecting wood-based members, where requirements for mechanical resistance and stability and safety in use in the sense of the essential Requirements N 1 and N 4 of Council Directive 89/106/EEC shall be fulfilled.

The screws are used for connections in load bearing timber structures between wood-based members or between those members and steel members:

- Solid timber of softwood of strength classes C14–C40 according to EN 338<sup>7</sup>/ EN 14081-1<sup>8</sup>,
- Solid timber of beech or oak according to EN 338/ EN 14081-1,
- Glued laminated timber of at least strength class GL24c according to EN 1194<sup>9</sup>/ EN 14080<sup>10</sup>,
- Glued laminated timber of beech or oak according to European technical approvals or national provisions that apply at the installation site,
- Laminated veneer lumber LVL according to EN 14374<sup>11</sup>,
- Glued solid timber Duo- and Triobalken according to EN 14080 or national provisions that apply at the installation site,
- Cross-laminated timber according to European technical approvals or national provisions that apply at the installation site.

The screws may be used for connecting the following wood-based panels to the timber members mentioned above:

- Plywood according to EN 636<sup>12</sup> and EN 13986<sup>13</sup>,

7	EN 338:2009	Timber structures - Strength classes
8	EN 14081-1:2005+A1:2011	Timber structures – Strength graded structural timber with rectangular cross section – Part 1: General requirements
9	EN 1194:1999	Timber structures – Glued laminated timber – Strength classes and determination of characteristic values
10	EN 14080:2013	Timber structures - Glued laminated timber and glued solid timber - Requirements
11	EN 14374:2004	Timber structures - Structural laminated veneer lumber - Requirements
12	EN 636:2003	Plywood - Specifications
13	EN 13986:2004	Wood-based panels for use in construction - Characteristics, evaluation of conformity and marking

- Oriented Strand Board, OSB according to EN 300<sup>14</sup> and EN 13986,
- Particleboard according to EN 312<sup>15</sup> and EN 13986,
- Fibreboards according to EN 622-2<sup>16</sup>, EN 622-3<sup>17</sup> and EN 13986,
- Cement-bonded particle boards according to national provisions at the building site.

Wood-based panels shall only be arranged on the side of the screw head.

Würth "ASSY plus VG" and ASSY screws with full thread may be used for reinforcing of timber structures perpendicular to the grain. Würth "ASSY plus VG" screws may also be used for shear reinforcement.

Würth screws with an outer thread diameter of at least 6 mm may also be used for the fixing of thermal insulation material on rafters.

According to EN 1995-1-1<sup>18</sup> the screws made from carbon steel with  $d > 4$  mm may be used in timber structures subject to climate conditions defined by service classes 1 and 2. According to EN 1995-1-1 the screws made from carbon steel with  $d \leq 4$  mm may be used in timber structures subject to climate conditions defined by service class 1. Regarding environmental conditions national provisions at the building site shall apply.

Screws made of stainless steel may also be used in conditions defined by service class 3. The scope of the screws shall be defined according to national provisions that apply at the installation site.

The screws may be used for connections subject to static or quasi static loading.

The provisions made in this European technical approval are based on an assumed working life of the screws of 50 years, provided that the conditions laid down in section 4.2 for the installation are met. The indications given on the working life cannot be interpreted as a guarantee given by the producer, but are to be regarded only as a means for choosing the right products in relation to the expected economically reasonable working life of the works.

## 2 Characteristics of product

	Characteristic	Assessment of characteristic
2.1 Mechanical resistance and stability <sup>*)</sup>		
2.1.1	Dimensions	See Annex 6
2.1.2	Characteristic yield moment	See Annex 1
2.1.3	Characteristic withdrawal parameter	See Annex 1
2.1.4	Characteristic head pull-through parameter	See Annex 1
2.1.5	Characteristic tensile strength	See Annex 1

<sup>14</sup> EN 300:2006 Oriented strand boards (OSB) – Definition, classification and specifications

<sup>15</sup> EN 312:2010 Particleboards - Specifications

<sup>16</sup> EN 622-2:2004 Fibreboards – Specifications – Part 2: Requirements for hardboards

<sup>17</sup> EN 622-3:2004 Fibreboards - Specifications - Part 3: Requirements for medium boards

<sup>18</sup> EN 1995-1-1:2004+A1:2008 Eurocode 5: Design of timber structures – Part 1-1: General – Common rules and rules for buildings

<sup>\*)</sup> See section 2.1 of this ETA



	Characteristic	Assessment of characteristic
2.1.6	Characteristic yield strength	See Annex 1
2.1.7	Characteristic torsional strength	See Annex 1
2.1.8	Insertion moment	See Annex 1
2.1.9	Spacing, end and edge distances of the screws and minimum thickness of the wood based material	See Annex 1
2.1.10	Slip modulus for mainly axially loaded screws	See Annex 1
<b>2.2 Safety in case of fire</b>		
2.2.1	Reaction to fire	Self-tapping screws are made of steel classified as Euroclass A1 in accordance with EC decision 96/603/EC, as amended by EC decision 2000/605/EC.
<b>2.3 Hygiene, health and the environment</b>		
2.3.1	Content and/or release of dangerous substances	The product does not contain cadmium. There is no risk that chrome VI – contained in the chromated carbon steel screws – will be released by consideration of all possible release scenarios.**)
<b>2.4 Safety in use</b>		
2.4.1	Dimensions	See Annex 6
2.4.2	Characteristic yield moment	See Annex 1
2.4.3	Characteristic withdrawal parameter	See Annex 1
2.4.4	Characteristic head pull-through parameter	See Annex 1
2.4.5	Characteristic tensile strength	See Annex 1
2.4.6	Characteristic yield strength	See Annex 1
2.4.7	Characteristic torsional strength	See Annex 1
2.4.8	Insertion moment	See Annex 1

\*\*)

In accordance with <http://europa.eu.int/-/comm/enterprise/construction/internal/dangsub/dangmain.htm>. In addition to the specific clauses relating to dangerous substances contained in this European technical approval, there may be other requirements applicable to the products falling within its scope (e.g. transposed European legislation and national laws, regulations and administrative provisions). In order to meet the provisions of the EU Construction Products Directive, these requirements need also to be complied with, when and where they apply.

	Characteristic	Assessment of characteristic
2.4.9	Spacing, end and edge distances of the screws and minimum thickness of the wood based material	See Annex 1
2.4.10	Slip modulus for mainly axially loaded screws	See Annex 1
Protection against noise		Not relevant
Energy economy and heat retention		Not relevant
2.5 General aspects relating to fitness for use		
2.5.1	Durability against corrosion	See Annex 1
2.5.2	Serviceability	The assessment for mechanical resistance and stability as well as durability against corrosion covers this property.

## 2.1 Mechanical resistance and stability

Annexes 1 to 5 contain the load-carrying capacities for Würth self-tapping screws.

The design and construction shall be carried out according to national provisions that apply at the installation site in line with the partial safety factor format, e.g. in accordance with EN 1995-1-1.

## 3 Evaluation and attestation of conformity and CE marking

### 3.1 System of attestation of conformity

According to the decision 97/638/EC of the European Commission<sup>19</sup> the system 2+ of attestation of conformity applies.

This system of attestation of conformity is defined as follows:

System 2+: Declaration of conformity of the product by the manufacturer on the basis of:

- (a) Tasks for the manufacturer:
  - (1) initial type-testing of the product;
  - (2) factory production control;
  - (3) testing of samples taken at the factory in accordance with a prescribed test plan.
- (b) Tasks for the approved body:
  - (4) certification of factory production control on the basis of:
    - initial inspection of factory and of factory production control;
    - continuous surveillance, assessment and approval of factory production control.

Note: Approved bodies are also referred to as "notified bodies".

<sup>19</sup> Official Journal of the European Communities L 268/36 of 19 September 1997

## 3.2 Responsibilities

### 3.2.1 Tasks for the manufacturer

#### 3.2.1.1 Factory production control

The manufacturer shall exercise permanent internal control of production. All the elements, requirements and provisions adopted by the manufacturer shall be documented in a systematic manner in the form of written policies and procedures, including records of results performed. This production control system shall insure that the product is in conformity with this European technical approval.

The manufacturer may only use raw materials stated in the technical documentation of this European technical approval supplied with the relevant inspection documents as laid down in the control plan.

The factory production control shall be in accordance with the "control plan" relating to the European technical approval ETA-11/0190 issued on 27 June 2013" which is part of the technical documentation of this European technical approval. The control plan is laid down in the context of the factory production control system operated by the manufacturer and deposited with Deutsches Institut für Bautechnik.<sup>20</sup>

The incoming raw materials shall be subject to controls and tests by the manufacturer before acceptance. Check of materials, such as steel rods or wire, shall include control of the inspection documents presented by suppliers (comparison with nominal values) by verifying dimension and determining material properties, e.g. chemical composition, mechanical properties and corrosion protection.

The manufactured components shall be checked visually and for dimensions. The control plan includes details of the extent, nature and frequency of testing and controls to be performed within the factory production control.

The results of factory production control shall be recorded and evaluated in accordance with the provisions of the control plan. The records shall include at least the following information:

- Designation of the product, basic material and components,
- Type of control or testing,
- Date of manufacture of the product and date of testing of the product or basic material and components,
- Result of control and testing and, if appropriate, comparison with requirements,
- Signature of person responsible for factory production control.

The records shall be presented to the approved body involved in the continuous surveillance and shall be presented to Deutsches Institut für Bautechnik on request.

#### 3.2.1.2 Initial type testing

For initial type-testing the results of the tests performed as part of the assessment for the European technical approval may be used unless there are changes in the production line or plant. In such cases the necessary initial type-testing has to be agreed between Deutsches Institut für Bautechnik and the notified body.

<sup>20</sup> The "control plan" is a confidential part of the European technical approval and only handed over to the approved body/bodies involved in the procedure of attestation of conformity. See section 3.2.2.

#### 3.2.1.3 Other tasks for the manufacturer

The manufacturer shall, on the basis of a contract, involve a body which is approved for the tasks referred to in section 3.1 in the field of screws in order to undertake the actions laid down in section 3.2.2. For this purpose, the control plan referred to in sections 3.2.1.1 and 3.2.2 shall be handed over by the manufacturer to the approved body involved.

The manufacturer shall make a declaration of conformity, stating that the construction product is in conformity with the provisions of the European technical approval ETA-11/0190 issued on 27 June 2013.

### 3.2.2 Tasks for the approved bodies

The approved body shall perform the

- initial inspection of factory and of factory production control,
- continuous surveillance, assessment and approval of factory production control, in accordance with the provisions laid down in the control plan.

#### 3.2.2.1 Initial inspection of factory and factory production control

The approved body shall ascertain that, in accordance with the control plan, the factory, in particular the staff and equipment, and the factory production control, are suitable to ensure a continuous and orderly manufacturing of the screws with this European technical approval.

#### 3.2.2.2 Continuous surveillance

The approved body shall control the documentation of the factory production control (FPC) twice a year including an annual visit of the factory for routine inspections. It shall be verified that the system of factory production control and the specified manufacturing processes are maintained, taking account of the control plan.

#### 3.2.2.3 Other tasks of the approved body

The approved body shall retain the essential points of its actions referred to above and state the results obtained and conclusions drawn in a written report.

The results of certification and continuous surveillance shall be made available on demand by the certification body to Deutsches Institut für Bautechnik.

The approved certification body involved by the manufacturer shall issue an EC certificate of conformity of the factory production control stating the conformity with the provisions of this European technical approval.

In cases where the provisions of the European technical approval and its control plan are no longer fulfilled the certification body shall withdraw the certificate of conformity and inform Deutsches Institut für Bautechnik without delay.

### 3.3 CE marking

The CE marking shall be affixed on each packaging of the self-tapping screws. The letters "CE" shall be followed by the identification number of the approved certification body and be accompanied by the following additional information:

- the name and address of the producer (legal entity responsible for the manufacture),
- the last two digits of the year in which the CE marking was affixed,
- the number of the EC certificate for the factory production control,
- the number of the European technical approval,
- name of the product,
- outer thread diameter and length of the self-tapping screws,
- type and mean thickness of the corrosion protection, if relevant,

- Stainless steel including the material number, if relevant.

#### 4 Assumptions under which the fitness of the product for the intended use was favourably assessed

##### 4.1 Manufacturing

Würth self-tapping screws shall be manufactured in accordance with the provisions of this European technical approval using the manufacturing processes as identified at the inspection of the plant by the notified inspection body and laid down in the technical documentation.

The European technical approval is issued for the product on the basis of agreed data/information, deposited with Deutsches Institut für Bautechnik, which identifies the product that has been assessed and judged. Changes to the product or production process, which could result in this deposited data/information being incorrect, shall be notified to Deutsches Institut für Bautechnik before the changes are introduced. Deutsches Institut für Bautechnik will decide whether or not such changes affect the approval and consequently the validity of the CE marking on the basis of the approval and if so whether further assessment or alterations to the approval shall be necessary.

##### 4.2 Installation

The screws are either driven into the wood-based member made of softwood without pre-drilling or in pre-drilled holes with a diameter according to Table 1.

The screws are driven into wood-based members made of beech or oak in pre-drilled holes with a diameter according to Table 1.

Table 1 Diameter of the pre-drilled holes in softwood and in beech or oak

Outer thread diameter [mm]	Diameter of the pre-drilled hole with a tolerance of $\pm 0.1$ mm [mm]	
	Wood-based member made of softwood	Wood-based members made of beech or oak
4.0	2.5	3.0
4.5	2.5	3.5
5.0	3.0	3.5
6.0	4.0	4.0
7.0	4.0	5.0
8.0	5.0	6.0
10.0	6.0	7.0
12.0	7.0	8.0
14.0	8.0	9.0

The screw holes in steel members shall be pre-drilled with an adequate diameter greater than the outer thread diameter.

Würth screws with an outer thread diameter of  $d = 14$  mm and a length greater or equal than 800 mm shall be only driven in softwood in a guiding hole with a diameter of 8 mm and a minimum length of 10 percent of the screw length.

A minimum of two screws shall be used for connections in load-bearing timber structures. Only one screw may be used in structural connections when the minimum penetration length of the screw is  $20 \cdot d$  and the screw is systematic axially loaded. In the case the screw is used to connect wood-based members the load-bearing capacity of the screw shall be reduced by 50 %. If the screw is used as tensile or compressive reinforcement of timber structures perpendicular to the grain no reduction of the load-bearing capacity of the screw is necessary.

If screws with an outer thread diameter  $d \geq 8$  mm are driven into the wood-based member without pre-drilling, the structural solid or glued laminated timber, laminated veneer lumber, cross-laminated timber and similar glued members shall be from spruce, pine or fir.

In the case of fastening battens on thermal insulation material in rafters the screws shall be driven in the rafter through the battens and the thermal insulation material without pre-drilling in one sequence.

Countersunk head screws may be used with washers according to Annex 6, page 98. After inserting the screw the washers shall touch the surface of the wood-based member completely. In steel-wood-based members connections countersunk head screws may be used with washers according to Annex 6, page 99. Screws made from carbon steel shall be used with washers made from carbon steel and screws made from stainless steel shall be used with washers made from stainless steel.

By fastening screws in wood-based members the head of the screws shall be flush with the surface of the wood-based member. For pan head, top head, back panel head, Elmo-head, large washer head, joist hanger screw head, kombi hexagonal head, hexagonal head and hexalobular head the head part remains unconsidered.

## 5 Indications to the manufacturer

### 5.1 Use, maintenance, repair

The assessment of the fitness for use is based on the assumption that no maintenance is required during the assumed intended working life.

Andreas Kummerow  
p.p. Head of Department

*beglaubigt:*  
Dewitt

## ANNEX 1 Characteristic values of the load-carrying capacities

Table 1.1 Characteristic load-carrying capacities of Würth self-tapping screws made from carbon steel

Outer thread diameter [mm]		3.0	3.5	4.0	4.5	5.0	6.0	7.0	8.0	10.0	12.0	14.0
Characteristic yield moment $M_{y,k}$ [Nm]	ASSY plus VG	-	-	-	-	-	9.5	-	20.0	36.0	58.0	86.0
	ASSY plus VG Hot-dip galvanised	-	-	-	-	-	-	-	-	-	-	86.0
	ASSY Isotop 8.0/10.0	-	-	-	-	-	-	-	11.0	-	-	-
	Remaining screws	1.6	1.8	3.3	3.7	5.9	9.5	14.0	20.0	36.0	58.0	-
Characteristic tensile strength $f_{tens,k}$ [kN]	ASSY plus VG	-	-	-	-	-	11.0	-	20.0	32.0	45.0	62.0
	ASSY plus VG Hot-dip galvanised	-	-	-	-	-	-	-	-	-	-	47.0
	ASSY Isotop 8.0/10.0	-	-	-	-	-	-	-	11.0	-	-	-
	Remaining screws	2.8	3.0	5.0	5.3	7.9	11.0	15.0	20.0	26.0	41.0	-
Characteristic torsional strength $f_{tor,k}$ [Nm]	ASSY plus VG	-	-	-	-	-	10.0	-	23.0	45.0	75.0	115
	ASSY plus VG Hot-dip galvanised	-	-	-	-	-	-	-	-	-	-	100
	ASSY Isotop 8.0/10.0	-	-	-	-	-	-	-	20 <sup>a)</sup>	-	-	-
									12 <sup>b)</sup>			
Remaining screws	1.5	2.0	3.0	4.3	6.0	10.0	15.0	23.0	45.0	65.0	-	
a) head side												
b) point side												

Table 1.2 Characteristic load-carrying capacities of Würth self-tapping screws made from stainless steel

Outer thread diameter [mm]	3.0	3.5	4.0	4.5	5.0	5.5	6.0	6.5	8.0	10.0
Characteristic yield moment $M_{y,k}$ [Nm]	0.9	1.4	1.9	2.3	2.8	4.4	5.5	6.8	11.0	20.0
Characteristic tensile strength $f_{tens,k}$ [kN]	1.8	2.4	3.1	3.6	4.2	5.9	7.1	8.3	12.0	18.8
Characteristic torsional strength $f_{tor,k}$ [Nm]	0.85	1.35	2.0	2.6	3.3	5.0	6.4	7.5	16.0	30.0

Würth self-tapping screws	Annex 1
Characteristic values of the load-carrying capacities	



### A.1.1 General

The minimum penetration length of screws in the load-bearing wood-based members shall be  $4 \cdot d$ , where  $d$  is the outer thread diameter.

The outer thread diameter of screws inserted in cross laminated timber shall be at least 6 mm. To connect cross-laminated timber the inner thread diameter  $d_1$  of the screws shall be greater than the maximal width of the gaps in the layer.

### A.1.2 Laterally loaded screws

#### A.1.2.1 General

The outer thread diameter  $d$  shall be used as effective diameter of the screw according to EN 1995-1-1.

For steel-to-timber connections with screws  $d = 5$  mm with joist hanger screw head, a thick steel plate may be assumed for steel plate thickness  $t \geq 1,5$  mm.

#### A.1.2.2 Solid timber, glued laminated timber and glued solid timber

The embedding strength for screws in non-pre-drilled holes in softwood arranged at an angle between screw axis and grain direction,  $0^\circ \leq \alpha \leq 90^\circ$  is:

$$f_{h,k} = \frac{0.082 \cdot \rho_k \cdot d^{-0.3}}{2.5 \cdot \cos^2 \alpha + \sin^2 \alpha} \quad (1.1)$$

The embedding strength for screws in pre-drilled holes in softwood or beech or oak wood arranged at an angle between screw axis and grain direction,  $0^\circ \leq \alpha \leq 90^\circ$  is:

$$f_{h,k} = \frac{0.082 \cdot \rho_k \cdot (1 - 0.01 \cdot d)}{2.5 \cdot \cos^2 \alpha + \sin^2 \alpha} \quad (1.2)$$

where

$\rho_k$  characteristic density of the wood-based member, for beech and oak the assumed characteristic density shall not exceed  $590 \text{ kg/m}^3$

$d$  outer thread diameter of the screw [mm]

$\alpha$  angle between screw axis and grain direction,  $0^\circ \leq \alpha \leq 90^\circ$ .

#### A.1.2.3 Laminated veneer lumber

The embedding strength for screws in the edges of LVL shall be assumed as one third of the respective value for screws in the wide face.

#### A.1.2.4 Cross laminated timber

The embedding strength for screws arranged in the lateral surfaces parallel to the plane of cross laminated timber may be assumed according to equation (1.3) independent of the angle between screw axis and grain direction,  $0^\circ \leq \alpha \leq 90^\circ$ :

$$f_{h,k} = 20 \cdot d^{-0.5} \text{ in N/mm}^2 \quad (1.3)$$

Where  $d$  is the outer thread diameter of the screws in mm.

Equation (1.3) is only valid for softwood layers. The provisions in the European technical approval or national approvals of the cross laminated timber applies.

The embedding strength for screws in the wide face of cross laminated timber should be assumed as for solid timber based on the characteristic density of the outer layer. Where applicable, the angle between force and grain direction of the outer layer shall be taken into account. The direction of the lateral force shall be perpendicular to the screw axis and parallel to the wide face of the cross laminated timber.

Würth self-tapping screws	Annex 1
Characteristic values of the load-carrying capacities	

For angles  $45^\circ \leq \alpha < 90^\circ$  between screw axis and grain direction of the outer layer the characteristic load-carrying capacity may be assumed as 2/3 of the corresponding value for  $\alpha = 90^\circ$ , if only the penetration depth perpendicular to the wide face is taken into account.

### A.1.3 Axially loaded screws

The axial slip modulus  $K_{ser}$  of the threaded part of a screw for the serviceability limit state per side shall be taken independent of angle  $\alpha$  to the grain as:

$$K_{ser} = 780 \cdot d^{0,2} \cdot l_{ef}^{0,4} \quad [\text{N/mm}] \quad (1.4)$$

where

$d$  outer thread diameter of the screw [mm]

$l_{ef}$  penetration length of the screw in the wood-based member [mm].

#### A.1.3.1 Axial withdrawal capacity

The characteristic withdrawal capacity in solid timber (softwood or hardwood species beech and oak), glued laminated timber (softwood or hardwood species beech and oak), cross laminated timber or laminated veneer lumber members at an angle of  $0^\circ \leq \alpha \leq 90^\circ$  to the grain shall be calculated as:

$$F_{ax,\alpha,Rk} = n_{ef} \cdot k_{ax} \cdot f_{ax,k} \cdot d \cdot l_{ef} \cdot \left( \frac{\rho_k}{350} \right)^{0,8} \quad (1.5)$$

where

$F_{ax,\alpha,Rk}$  characteristic withdrawal capacity of a screw group at an angle  $\alpha$  to the grain [N]

$n_{ef}$  effective number of screws according to EN 1995-1-1, clause 8.7.2 (8)

For inclined screws with an angle between shear plane and screw axis  $30^\circ \leq \alpha \leq 60^\circ$ :

$$n_{ef} = \max \{ n^{0,9}; 0,9 \cdot n \} \quad (1.6)$$

For screws as compression reinforcement or inclined screws as fasteners in mechanically jointed beams or columns or for the fixing of thermal insulation material,  $n_{ef} = n$ .

$n$  number of screws acting together in a connection

$k_{ax}$  Factor, taking into account the angle  $\alpha$  between screw axis and grain direction

$$k_{ax} = 1,0 \quad \text{for } 45^\circ \leq \alpha \leq 90^\circ$$

$$k_{ax} = 0,3 + \frac{0,7 \cdot \alpha}{45^\circ} \quad \text{for } 0^\circ \leq \alpha < 45^\circ$$

$f_{ax,k}$  characteristic withdrawal parameter based on a characteristic density of the wood-based member of 350 kg/m<sup>3</sup>

$$f_{ax,k} = 12,0 \text{ N/mm}^2 \text{ for screws with } 3,0 \text{ mm} \leq d \leq 5,0 \text{ mm}$$

$$f_{ax,k} = 11,5 \text{ N/mm}^2 \text{ for screws with } 6,0 \text{ mm} \leq d \leq 7,0 \text{ mm and ASSY Isotop screws}$$

$$f_{ax,k} = 11,0 \text{ N/mm}^2 \text{ for screws with } d = 8,0 \text{ mm}$$

$$f_{ax,k} = 10,0 \text{ N/mm}^2 \text{ for screws with } d \geq 10,0 \text{ mm.}$$

The characteristic withdrawal parameter is also valid for softwood layers of cross-laminated timber.

For screws penetrating more than one layer of cross laminated timber the different layers may be taken into account proportionally. In the lateral surfaces of the cross laminated timber the screws shall be fully inserted in one layer of cross-laminated timber.

For beech and oak wood a maximum characteristic density of 590 kg/m<sup>3</sup> shall be used in equation (8.40a) of EN 1995-1-1.

Würth self-tapping screws	Annex 1
Characteristic values of the load-carrying capacities	

### A.1.3.2 Head pull-through capacity

The characteristic value of the head pull-through parameter for Würth screws for a characteristic density of 350 kg/m<sup>3</sup> of the timber and for wood-based panels like

- plywood according to EN 636 and EN 13986
- oriented Strand Board, OSB according to EN 300 and EN 13986
- particleboard according to EN 312 and EN 13986
- fibreboards according to EN 622-2, EN 622-3 and EN 13986
- cement-bonded particle boards according to national provisions at the building site

with a thickness of more than 20 mm is

$f_{head,k} = 13.0 \text{ N/mm}^2$  for Würth screws with a head diameter  $d_h \leq 19 \text{ mm}$  and

$f_{head,k} = 10.0 \text{ N/mm}^2$  for Würth screws with a head diameter  $d_h > 19 \text{ mm}$  or for washers.

For wood-based panels a maximum characteristic density of 380 kg/m<sup>3</sup> and for beech and oak wood a maximum characteristic density of 590 kg/m<sup>3</sup> shall be used in equation (8.40b) of EN 1995-1-1.

The head diameter shall be equal to or greater than  $1,8 \cdot d_s$ , where  $d_s$  is the smooth shank or the wire diameter. Otherwise the characteristic head pull-through capacity in equation (8.40b) is for all wood-based materials:  $F_{ax,\alpha,Rk} = 0$ . For wood based panels with a thickness between 12 mm and 20 mm the characteristic value of the head pull-through parameter for Würth screws is:

$$f_{head,k} = 8 \text{ N/mm}^2$$

For wood based panels with a thickness of less than 12 mm the characteristic head pull-through capacity for Würth screws shall be based on a characteristic value of the head pull-through parameter of 8 N/mm<sup>2</sup>, and limited to 400 N complying with the minimum thickness of the wood based panels of  $1,2 \cdot d$ , with  $d$  as outer thread diameter and the values in Table 1.3.

Table 1.3 Minimum thickness of wood based panels

Wood based panel	Minimum thickness [mm]
Plywood	6
Oriented Strand Boards, OSB	8
Particleboards	8
Fibreboards (hardboards and medium boards)	6
Cement-bonded particle boards	8

Outer diameter of washers  $d_k > 32 \text{ mm}$  shall not be considered.

For Würth ASSY plus VG screws, ASSY screws with a full thread and ASSY screws with a thread under the head the withdrawal capacity of the thread in the wood-based member with the screw head may be taken into account instead of the head pull-through capacity.

That also applies for screws with a thread over a part of the screw length. The minimum penetration length of the thread of  $4 \cdot d$  shall be considered in the timber member near the screw head.

In steel-to-timber connections the head pull-through capacity is not governing.

Würth self-tapping screws	Annex 1
Characteristic values of the load-carrying capacities	

### A.1.3.3 Compressive capacity

The design axial capacity  $F_{ax,Rd}$  of Würth ASSY plus VG screws and ASSY screws with a full thread embedded in softwood timber members is the minimum of the axial resistance against pushing-in and the buckling resistance of the screw.

$$F_{ax,Rd} = \min \{ f_{ax,d} \cdot d \cdot l_{ef}; \kappa_c \cdot N_{pl,d} \} \quad (1.7)$$

$f_{ax,d}$  design value of the axial withdrawal capacity of the threaded part of the screw [N/mm<sup>2</sup>]

$d$  outer thread diameter of the screw [mm]

$l_{ef}$  penetration length of the threaded part of the screw in the timber member [mm]

$$\kappa_c = 1 \quad \text{für } \bar{\lambda}_k \leq 0,2 \quad (1.8)$$

$$\kappa_c = \frac{1}{k + \sqrt{k^2 - \bar{\lambda}_k^2}} \quad \text{für } \bar{\lambda}_k > 0,2 \quad (1.9)$$

$$k = 0,5 \cdot \left[ 1 + 0,49 \cdot (\bar{\lambda}_k - 0,2) + \bar{\lambda}_k^2 \right] \quad (1.10)$$

and a relative slenderness ratio  $\bar{\lambda}_k = \sqrt{\frac{N_{pl,k}}{N_{ki,k}}}$  (1.11)

where:

$N_{pl,k}$  characteristic plastic normal force related to the net cross-section of the inner thread diameter:

$$N_{pl,k} = \pi \cdot \frac{d_1^2}{4} \cdot f_{y,k} \quad (1.12)$$

$f_{y,k}$  characteristic yield strength,  $f_{y,k} = 1000$  N/mm<sup>2</sup> for Würth ASSY plus VG and ASSY screws with full thread  
 $f_{y,k} = 800$  N/mm<sup>2</sup> for hot-dip galvanised Würth ASSY plus VG screws

$d_1$  inner thread diameter of the screw [mm]

$$N_{pl,d} = \frac{N_{pl,k}}{\gamma_{M1}} \quad (1.13)$$

$\gamma_{M1}$  partial factor according to EN 1993-1-1 or to the particular national annex

characteristic ideal elastic buckling load:

$$N_{ki,k} = \sqrt{c_h \cdot E_s \cdot I_s} \quad [\text{N}] \quad (1.14)$$

elastic foundation of the screw:

$$c_h = (0.19 + 0.012 \cdot d) \cdot \rho_k \cdot \left( \frac{90^\circ + \alpha}{180^\circ} \right) \quad [\text{N/mm}^2] \quad (1.15)$$

$\rho_k$  characteristic density of the wood-based member [kg/m<sup>3</sup>]

$\alpha$  angle between screw axis and grain direction,  $30^\circ \leq \alpha \leq 90^\circ$

modulus of elasticity:

$$E_s = 210.000 \text{ N/mm}^2$$

second moment of area:

$$I_s = \frac{\pi \cdot d_1^4}{64} \quad [\text{mm}^4] \quad (1.16)$$

Würth self-tapping screws	Annex 1
Characteristic values of the load-carrying capacities	

#### A.1.4 Spacing, end and edge distances of the screws and minimum thickness of the wood based material

Minimum thickness for structural members is  $t = 24$  mm for screws with  $d < 8$  mm,  $t = 30$  mm for screws with  $d = 8$  mm,  $t = 40$  mm for screws with  $d = 10$  mm and  $t = 80$  mm for screws with  $d = 12$  mm.

##### A.1.4.1 Laterally and/or axially loaded screws

Screws in pre-drilled holes

For Würth screws in pre-drilled holes, for ASSY plus and ASSY plus VG screws also in non pre-drilled holes in softwood, the minimum spacings, end and edge distances are given in EN 1995-1-1:2004+A1: 2008, clause 8.3.1.2 and Table 8.2 as for nails in pre-drilled holes. Here, the outer thread diameter  $d$  shall be considered.

Screws in non pre-drilled holes

For Würth screws except ASSY plus and ASSY plus VG screws in non pre-drilled holes minimum spacing and distances are given in EN 1995-1-1:2004+A1: 2008, clause 8.3.1.2 and Table 8.2 as for nails in non pre-drilled holes.

For Douglas fir members minimum spacing and distances parallel to the grain shall be increased by 50%.

Minimum distances from loaded or unloaded ends shall be  $15 \cdot d$  for screws with outer thread diameter  $d > 8$  mm and timber thickness  $t < 5 \cdot d$ .

Minimum distances from the unloaded edge perpendicular to the grain may be reduced to  $3 \cdot d$  also for timber thickness  $t < 5 \cdot d$ , if the spacing parallel to the grain and the end distance is at least  $25 \cdot d$ .

##### A.1.4.2 Only axially loaded screws

For ASSY plus and ASSY plus VG screws loaded only axially, the following minimum spacings, end and edge distances apply alternatively to paragraph A.1.4.1 for solid timber, glued laminated timber and similar glued products:

Spacing $a_1$ in a plane parallel to grain:	$a_1 = 5 \cdot d$
Spacing $a_2$ perpendicular to a plane parallel to grain:	$a_2 = 2.5 \cdot d$
End distance of the centre of gravity of the threaded part in the timber member:	$a_{1,C} = 5 \cdot d$
Edge distance of the centre of gravity of the threaded part in the timber member:	$a_{2,C} = 3 \cdot d$
Product of spacing $a_1$ and $a_2$ :	$a_1 \cdot a_2 = 25 \cdot d^2$

For screws in non pre-drilled holes a minimum timber thickness of  $10 d$  and a minimum width of  $8 d$  or  $60$  mm, whichever is the greater, are required.

For ASSY plus and ASSY plus VG screws only loaded axially, the following minimum spacings, end and edge distances apply for laminated veneer lumber (LVL):

Spacing $a_1$ in a plane parallel to grain:	$a_1 = 5 \cdot d$
Spacing $a_2$ perpendicular to a plane parallel to grain:	$a_2 = 2.5 \cdot d$
End distance of the centre of gravity of the threaded part in the timber member:	$a_{1,C} = 5 \cdot d$
Edge distance of the centre of gravity of the threaded part in the timber member:	$a_{2,C} = 3 \cdot d$
Product of spacing $a_1$ and $a_2$ :	$a_1 \cdot a_2 = 25 \cdot d^2$

For screws in non pre-drilled holes a minimum LVL thickness of  $6 d$  and a minimum width of  $8 d$  or  $60$  mm, whichever is the greater, are required.

Würth self-tapping screws	Annex 1
Characteristic values of the load-carrying capacities	

For a crossed screw couple in solid timber, glued laminated timber and similar glued products or in laminated veneer lumber the minimum spacing between the crossing screws is  $1.5 \cdot d$ .

#### A.1.4.3 Cross laminated timber

The minimum requirements for spacing, end and edge distances of screws in the plane or edge surfaces of cross laminated timber are summarised in Table 1.4. The definition of spacing, end and edge distance is shown in Figure 1.1 and Figure 1.2. The minimum spacing, end and edge distances in the edge surfaces are independent of the angle between screw axis and grain direction. They may be used based on the following conditions:

- Minimum thickness of cross laminated timber:  $10 \cdot d$
- Minimum penetration depth in the edge surface:  $10 \cdot d$

For load components perpendicular to the plane surface (see Figure 1.1), the tensile stresses perpendicular to the grain should be transferred by reinforcing screws.

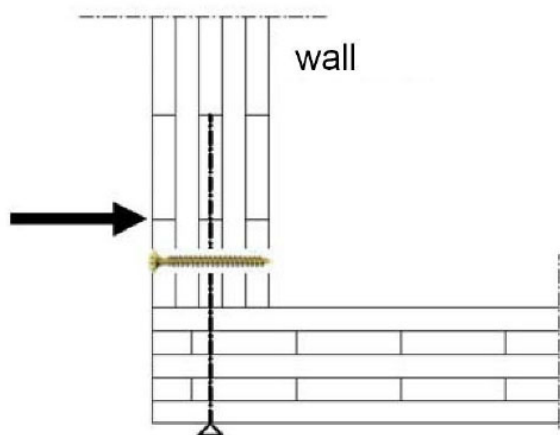

Figure 1.1: Reinforcing screw in cross-laminated timber loaded by tensile stress perpendicular to the grain

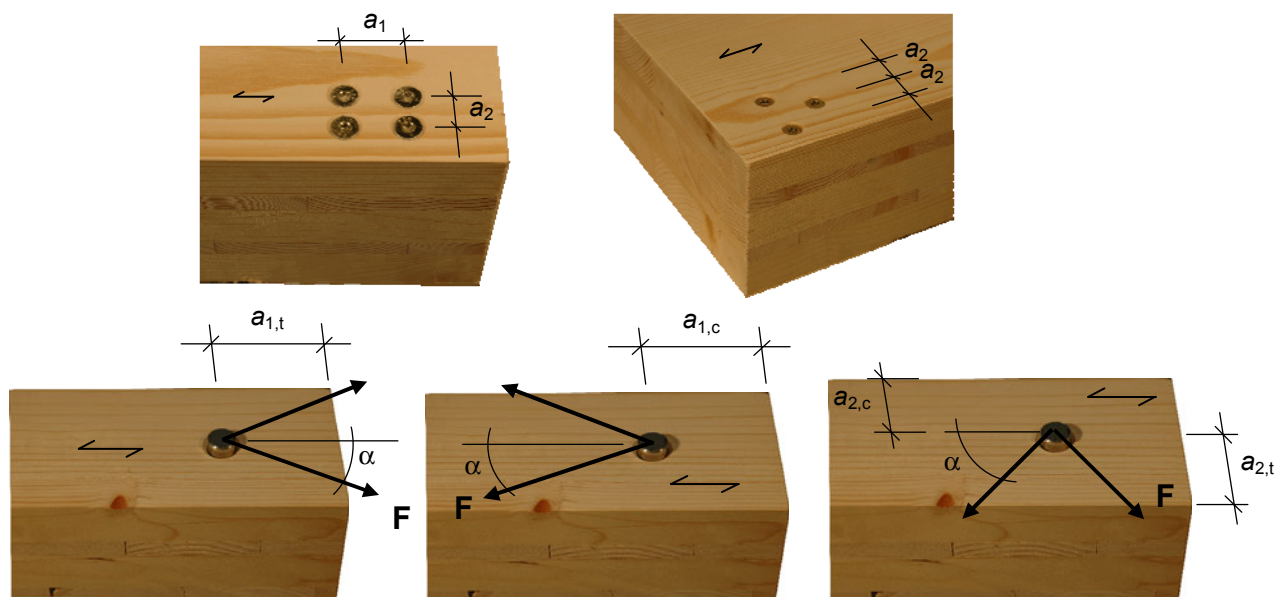

Figure 1.2: Definition of spacing, end and edge distances in the plane surface

Würth self-tapping screws	Annex 1
Characteristic values of the load-carrying capacities	

Table 1.4: Minimum spacing, end and edge distances of screws in the plane or edge surfaces of cross laminated timber

	$a_1$	$a_{1,t}$	$a_{1,c}$	$a_2$	$a_{2,t}$	$a_{2,c}$
Plane surface (see Figure 1.2)	$4 \cdot d$	$6 \cdot d$	$6 \cdot d$	$2,5 \cdot d$	$6 \cdot d$	$2,5 \cdot d$
Edge surface (see Figure 1.3)	$10 \cdot d$	$12 \cdot d$	$7 \cdot d$	$4 \cdot d$	$6 \cdot d$	$3 \cdot d$

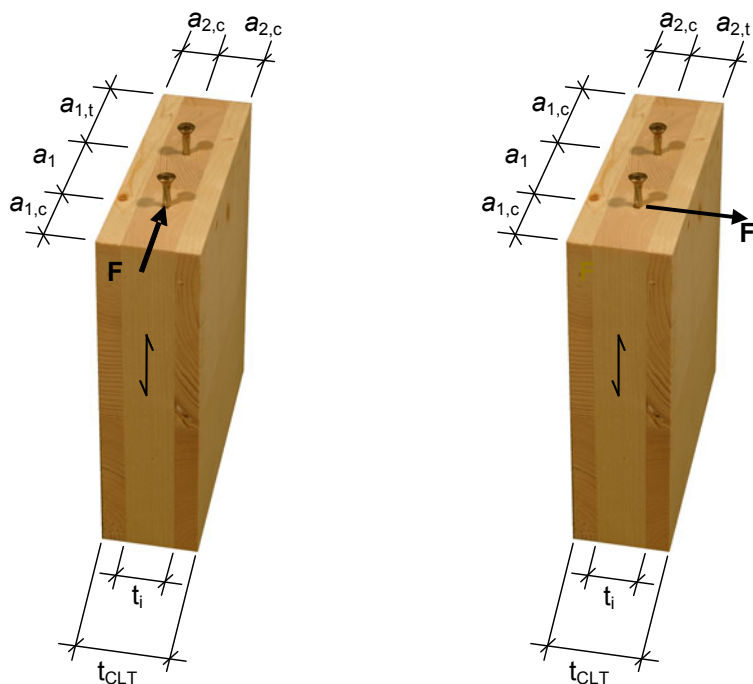

Figure 1.3: Definition of spacing, end and edge distances in the edge surface

### A.1.5 Insertion moment

The ratio between the characteristic torsional strength  $f_{tor,k}$  and the mean value of insertion moment  $R_{tor,mean}$  fulfills the requirement for all screws.

### A.1.6 Durability against corrosion

Screws and washers made from carbon steel are uncoated, brass-plated, nickel-plated, browned or electrogalvanised, black galvanised, yellow or blue chromated, zinc-lamella coated, aluminium coated or Ruspert coated or have a zinc-nickel coating. Würth ASSY plus VG with  $d = 14$  mm may be hot-dip galvanised.

The mean thickness of the zinc coating of the screws is  $5 \mu\text{m}$  and of the zinc-nickel coating  $4 \mu\text{m}$ .

Steel no. 1.4006, 1.4009, 1.4021, 1.4301, 1.4401, 1.4529, 1.4571, 1.4567, 1.4578 and 1.4539 is used for screws and washers made from stainless steel.

Würth self-tapping screws	Annex 1
Characteristic values of the load-carrying capacities	



## ANNEX 2 Compression reinforcement perpendicular to the grain

### A.2.1 General

Only Würth ASSY plus VG and ASSY screws with full thread shall be used for compression reinforcement perpendicular to the grain.

The compression force shall evenly be distributed to the screws used as compression reinforcement.

The screws are driven into the timber member perpendicular to the contact surface under an angle between the screw axis and the grain direction of 45° to 90°. The screw heads must be flush with the timber surface.

Compressive reinforcing screws for wood-based panels and timber members made of hardwood are not covered by this European technical approval.

### A.2.2 Design

For the design of reinforced contact areas the following conditions must be met independently of the angle between the screw axis and the grain direction.

The design resistance of a reinforced contact area is:

$$R_{90,d} = \min \left\{ \begin{array}{l} k_{c,90} \cdot B \cdot \ell_{ef,1} \cdot f_{c,90,d} + n \cdot \min \{ R_{ax,d}; \kappa_c \cdot N_{pl,d} \} \\ B \cdot \ell_{ef,2} \cdot f_{c,90,d} \end{array} \right\} \quad (2.1)$$

where:

$k_{c,90}$  parameter according to EN 1995-1-1:2004+A1: 2008, 6.1.5

$B$  bearing width [mm]

$\ell_{ef,1}$  effective contact length according to EN 1995-1-1:2004+A1: 2008, 6.1.5 [mm]

$f_{c,90,d}$  design compressive strength perpendicular to the grain [N/mm<sup>2</sup>]

$n$  number of reinforcing screws,  $n = n_0 \cdot n_{90}$

$n_0$  number of reinforcing screws arranged in a row parallel to the grain

$n_{90}$  number of reinforcing screws arranged in a row perpendicular to the grain

$$R_{ax,d} = f_{ax,d} \cdot d \cdot \ell_{ef} \quad [N] \quad (2.2)$$

$f_{ax,d}$  design value of the axial withdrawal capacity of the threaded part of the screw [N/mm<sup>2</sup>]

$d$  outer thread diameter of the screw [mm]

$\kappa_c$  according to Annex 1, chapter "compressive capacity"

$N_{pl,d}$  according to Annex 1, chapter "compressive capacity" [N]

$\ell_{ef,2}$  effective contact length in the plane of the screw tips (see Figure 2.1) [mm]

$$\ell_{ef,2} = \{ \ell_{ef} + (n_0 - 1) \cdot a_1 + \min(\ell_{ef}; a_{1,C}) \} \text{ for end supports (see Figure 2.1 left)}$$

$$\ell_{ef,2} = \{ 2 \cdot \ell_{ef} + (n_0 - 1) \cdot a_1 \} \text{ for intermediate supports (see Figure 2.1 right)}$$

$\ell_{ef}$  penetration length of the threaded part of the screw in the timber member [mm]

$a_1$  spacing  $a_1$  in a plane parallel to grain, see chapter A.1.4.2 [mm]

$a_{1,C}$  end distance of the centre of gravity of the threaded part in the timber member, see chapter A.1.4.2 [mm]

Würth self-tapping screws	Annex 2
Compression reinforcement perpendicular to the grain	

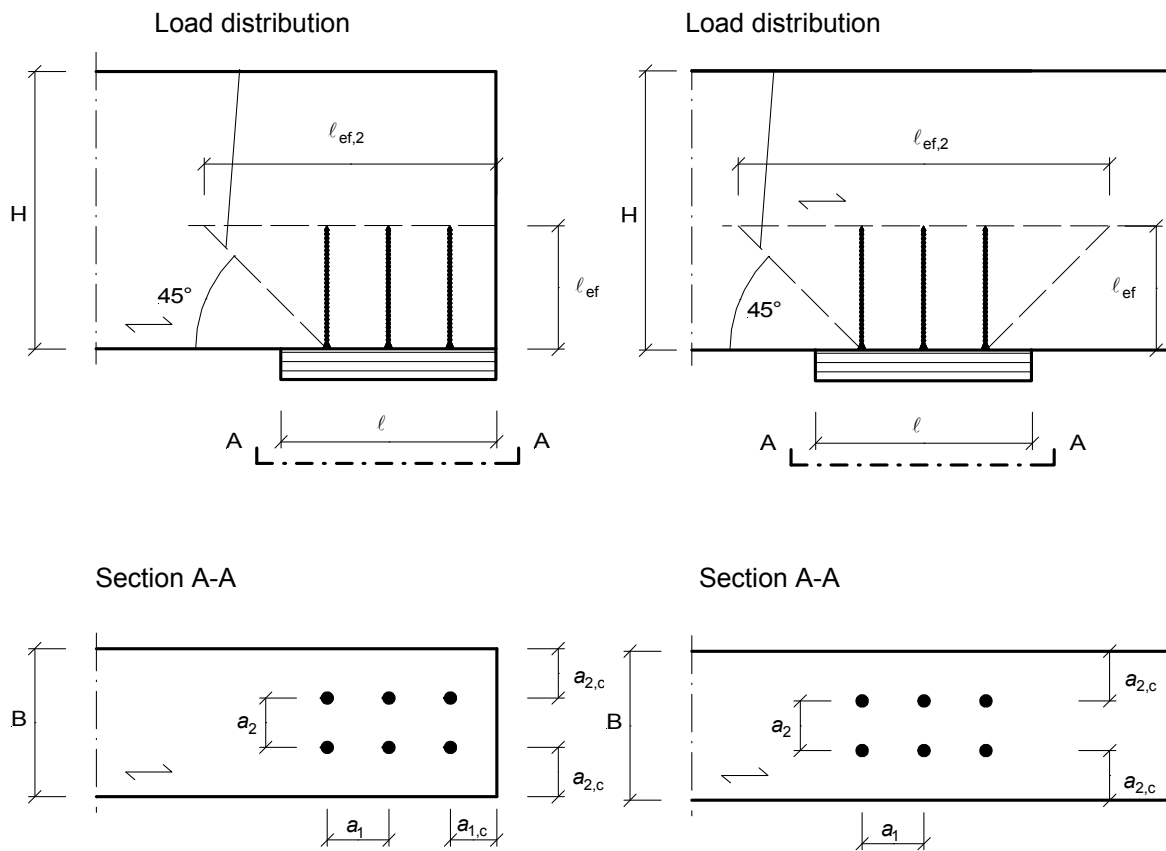

Figure 2.1: Reinforced end support (left) and reinforced intermediate support (right)

Würth self-tapping screws	Annex 2
Compression reinforcement perpendicular to the grain	

## ANNEX 3 Tensile reinforcement perpendicular to grain

### A.3.1 General

Only Würth ASSY plus VG and ASSY screws with full thread shall be used for tensile reinforcement perpendicular to the grain.

The screws are driven into the timber member perpendicular to the contact surface under an angle between the screw axis and the grain direction of 90°.

The provisions regarding tensile reinforcement perpendicular to the grain are valid for the following timber members:

- solid timber of softwood or of the hardwood species beech or oak,
- glued laminated timber made of softwood or of the hardwood species beech or oak,
- glued solid timber made of softwood or of the hardwood species beech or oak,
- laminated veneer lumber.

For the design and construction of the tensile reinforcement of timber members perpendicular to the grain, the provisions at the place of installation shall apply. As examples connection forces at an angle to the grain and notched beam supports are given in the following.

Note: For example, in Germany the provisions of standard DIN EN 1995-1-1/NA:2010-12, NCI NA.6.8 and amendments shall be taken into account.

A minimum of two screws shall be used for tensile reinforcement perpendicular to the grain. Only one screw may be used when the minimum penetration depth of the screws below and above the potential crack is  $20 \cdot d$  where  $d$  is the outer thread diameter of the screw.

### A.3.2 Design

#### A.3.2.1 Connection forces at an angle to the grain

The axial capacity of a reinforcement of a timber member loaded by a connection force perpendicular to the grain shall fulfil the following condition:

$$\frac{[1 - 3 \cdot \alpha^2 + 2 \cdot \alpha^3] \cdot F_{90,d}}{F_{ax,Rd}} \leq 1 \quad (3.1)$$

where

$F_{90,d}$  design value of the force component perpendicular to the grain,

$\alpha = a/h$

$a$  see Figure 3.1

$h$  = member depth

$F_{ax,Rd} = \min \{ f_{ax,d} \cdot d \cdot l_{ef}; F_{t,Rd} \}$

$f_{ax,d}$  design value of the axial withdrawal capacity of the threaded part of the screw

$d$  outer thread diameter of the screw

$l_{ef}$  smaller value of the penetration depth below or above the potential crack

$F_{t,Rd}$  design value of the tensile resistance of the screw

Outside the connection only one screw each in longitudinal direction of the beam shall be taken into account.

Würth self-tapping screws	Annex 3
Tensile reinforcement perpendicular to the grain	

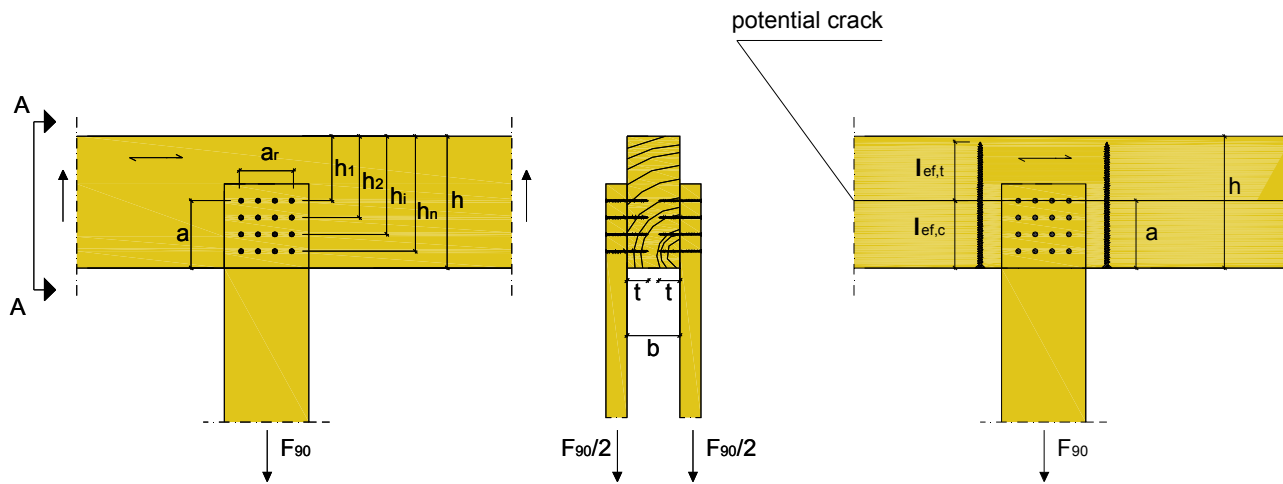

Figure 3.1: Example for tensile reinforcement of a connection force perpendicular to the grain

Würth self-tapping screws	Annex 3
Tensile reinforcement perpendicular to the grain	

### A.3.2.1 Notched beam supports

The axial capacity of a reinforcement of a notched beam support shall fulfil the following condition:

$$\frac{1,3 \cdot V_d \cdot \left[ 3 \cdot (1-\alpha)^2 - 2 \cdot (1-\alpha)^3 \right]}{F_{ax,Rd}} \leq 1 \quad (3.2)$$

where

$V_d$  design value of the shear force

$\alpha = h_e/h$

$h$  = member depth

$F_{ax,Rd} = \min \{ f_{ax,d} \cdot d \cdot l_{ef}; F_{t,Rd} \}$

$f_{ax,d}$  design value of the axial withdrawal capacity of the threaded part of the screw

$d$  outer thread diameter of the screw

$l_{ef}$  smaller value of the penetration depth below or above the potential crack, the total minimum penetration depth of the screw shall be  $2 \cdot l_{ef}$

$F_{t,Rd}$  design value of the tensile resistance of the screws

Only one screw in longitudinal direction of the beam shall be taken into account.

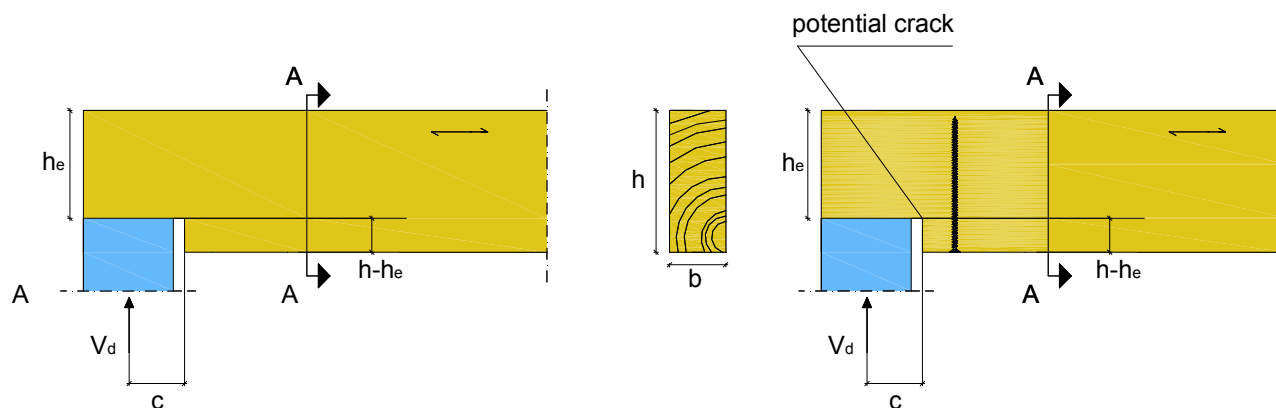

Figure 3.2: Example for tensile reinforcement of a notched beam support

Würth self-tapping screws	Annex 3
Tensile reinforcement perpendicular to the grain	

## ANNEX 4 Shear reinforcement

### A.4.1 General

Only Würth ASSY plus VG screws with full thread and  $d = 8$  mm shall be used for shear reinforcement of timber members. The provisions are valid for straight beams with constant rectangular cross-section.

The screws shall be driven into the timber member under an angle between the screw axis and the grain direction of  $45^\circ$ .

The provisions regarding shear reinforcement are valid for the following timber members:

- Glued laminated timber made of softwood and
- Glued solid timber made of softwood.

A minimum number of four screws shall be arranged in a line parallel to the grain as shear reinforcement. The spacing between the screws in a line parallel to the grain shall not exceed the depth  $h$  of the timber member.

For spacing, end and edge distances of the screws the provisions in Annex A.1.4 apply.

If the screws are arranged in one line parallel to the grain, it shall be done centrally in relation to the beam width.

Outside reinforced areas the shear design shall fulfil the conditions for unreinforced timber members.

For the design and construction of the shear reinforcement of timber members perpendicular to the grain, the provisions at the place of installation shall apply.

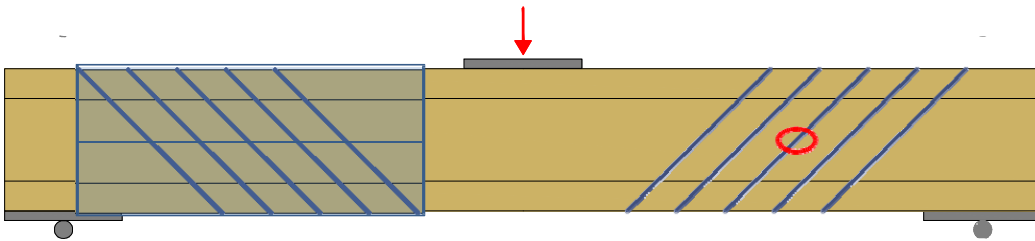

Figure 4.1: Principle of a shear reinforced beam using screws; marked area is reinforced

### A.4.2 Design

The provisions are valid for concentrated and linear loads.

For shear in reinforced areas of timber members according to Annex 4.1 with a stress component parallel to the grain, the following expression shall be satisfied:

$$\tau_d \leq f_{v,mod,d} = \frac{f_{v,d} \cdot k_\tau}{\eta_H} \quad (4.1)$$

where

$\tau_d$  design shear stress [N/mm<sup>2</sup>]  
 $f_{v,d}$  design shear strength [N/mm<sup>2</sup>]  
 $k_\tau = 1 - 0,46 \cdot \sigma_{90,d} - 0,052 \cdot \sigma_{90,d}^2$  [N/mm<sup>2</sup>] (4.2)

$\sigma_{90,d}$  design stress perpendicular to the grain (negative value for compression) [N/mm<sup>2</sup>]  
 $\sigma_{90,d} = \frac{F_{ax,d}}{\sqrt{2} \cdot b \cdot a_1}$  (4.3)

$b$  width of the timber member [mm]  
 $a_1$  screw spacing parallel to grain, screws arranged in one row [mm]

$F_{ax,d} = \frac{\sqrt{2} \cdot (1 - \eta_H) \cdot V_d \cdot a_1}{h}$  [N/mm<sup>2</sup>] (4.4)

Würth self-tapping screws	Annex 4
Shear reinforcement	

$$\eta_H = \frac{G \cdot b \cdot 2 \cdot \sqrt{2} \left( \frac{6}{\pi \cdot d \cdot h \cdot k_{ax}} + \frac{a_1}{E \cdot A_S} \right)}{1 + G \cdot b \cdot 2 \cdot \sqrt{2} \left( \frac{6}{\pi \cdot d \cdot h \cdot k_{ax}} + \frac{a_1}{E \cdot A_S} \right)} \quad (4.5)$$

$V_d$  design shear force [N]  
 $d$  outer thread diameter of the screw [mm]  
 $h$  depth of the timber member [mm]  
 $G$  mean value of shear modulus [N/mm<sup>2</sup>]  
 $k_{ax}$  connection stiffness between screw and timber member  
 $k_{ax} = 12,5 \text{ N/mm}^3$  for ASSY plus VG screws with  $d = 8 \text{ mm}$   
 $E \cdot A_S$  Axial stiffness of one screw

$$E \cdot A_S = \frac{E \cdot \pi \cdot d_1^2}{4} \quad (4.6)$$

$E$  modulus of elasticity,  $E = 210.000 \text{ N/mm}^2$   
 $d_1$  inner thread diameter of the screw [mm]

The axial capacity of a Würth "ASSY plus VG" screw shall fulfil the following condition:

$$\frac{F_{ax,d}}{F_{ax,Rd}} \leq 1 \quad (4.7)$$

where

$$F_{ax,Rd} = \min \left\{ f_{ax,d} \cdot d \cdot l_{ef}; f_{tens,d} \right\}$$

$f_{ax,d}$  design value of the axial withdrawal capacity of the threaded part of the screw [N/mm<sup>2</sup>]  
 $l_{ef}$  The effective penetration length is 50 percent of the threaded part length of the screw in the timber member [mm]  
 $f_{tens,d}$  design tensile strength of the screw [N]

Würth self-tapping screws	Annex 4
Shear reinforcement	



## ANNEX 5 Fastening of thermal insulation material on top of rafters

### A.5.1 General

Würth screws with an outer thread diameter of at least 6 mm may be used for the fixing of thermal insulation material on rafters or on wood-based members in vertical façades. In the following, the meaning of the word rafter includes wood-based members with inclinations between 0° and 90°.

The thickness of the thermal insulation material may be up to 400 mm. The thermal insulation material shall be applicable as insulation on top of rafters according to national provisions that apply at the installation site.

The battens have to be from solid timber according to EN 338/ EN 14081-1. The minimum thickness  $t$  and the minimum width  $b$  of the battens are given in Table 5.1:

Table 5.1 Minimum thickness and minimum width of the battens

Outer thread diameter [mm]	Minimum thickness $t$ [mm]	Minimum width $b$ [mm]
6, 6.5, 7 and 8	30	50
10	40	60
12	80	100
14	100	100

The spacing between screws  $e$  shall be not more than 1.75 m.

Friction forces shall not be considered for the design of the characteristic axial load of the screws.

The anchorage of wind suction forces as well as the bending stresses of the battens, respectively, shall be considered for design. Screws perpendicular to the grain of the rafter (angle  $\alpha = 90^\circ$ ) may be arranged if necessary.

### A.5.2 Parallel inclined screws and thermal insulation material in compression

#### A.5.2.1 Mechanical model

The system of rafter, thermal insulation material on top of rafter and battens parallel to the rafter may be considered as a beam on elastic foundation. The batten represents the beam, and the thermal insulation material on top of the rafter the elastic foundation. The minimum compression stress of the thermal insulation material at 10 % deformation, measured according to EN 826<sup>1</sup>, shall be  $\sigma_{(10\%)} = 0,05 \text{ N/mm}^2$ . The batten is loaded perpendicular to the axis by point loads  $F_b$ . Further point loads  $F_s$  are from the shear load of the roof due to dead and snow load, which are transferred from the screw heads into the battens.

Instead of battens the following wood-based panels may be used to cover the thermal insulation material if they are suitable for that use:

- Plywood according to EN 636 and EN 13986,
- Oriented Strand Board, OSB according to EN 300 and EN 13986,
- Particleboard according to EN 312 and EN 13986
- Fibreboards according to EN 622-2, EN 622-3 and EN 13986.

Only screws with countersunk head, 75° head, FBS head or woodwork head shall be used for fixing wood-based panels on rafters with thermal insulation material as interlayer.

The minimum thickness of the wood-based panels shall be 22 mm.

The word batten includes the meaning of wood-based panels in the following.

<sup>1</sup> EN 826:1996 Thermal insulating products for building applications - Determination of compression behaviour

Würth self-tapping screws	Annex 5
Fastening of thermal insulation material on top of rafters	

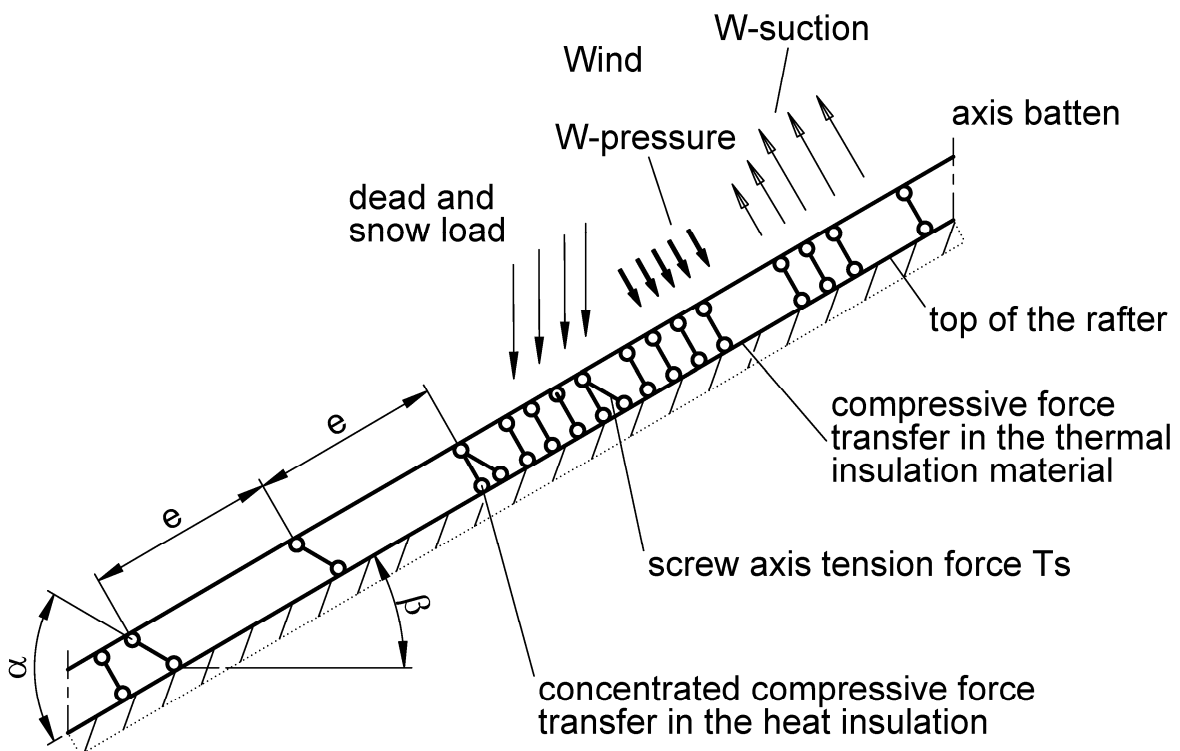
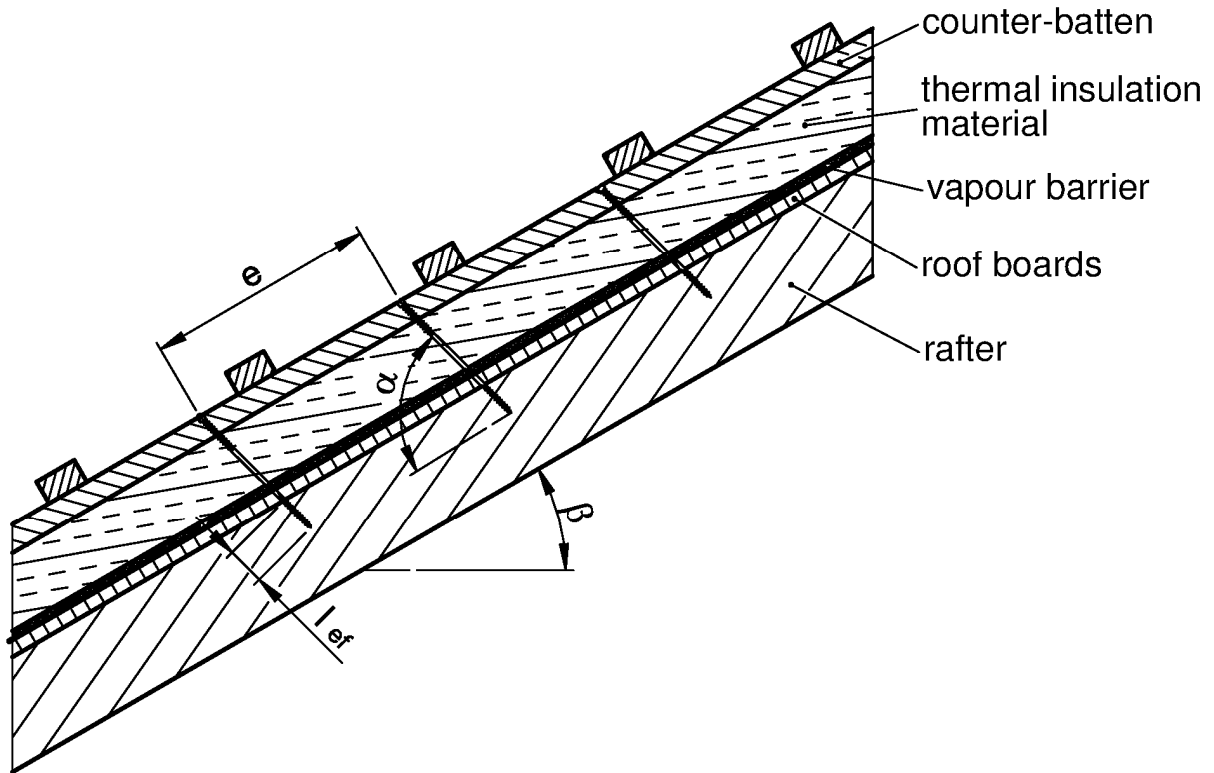

Figure 5.1 Fastening of the thermal insulation material on top of rafters - structural system for parallel inclined screws

Electronic copy of the ETA by DIBt: ETA-11/0190

Würth self-tapping screws	Annex 5
Fastening of thermal insulation material on top of rafters	

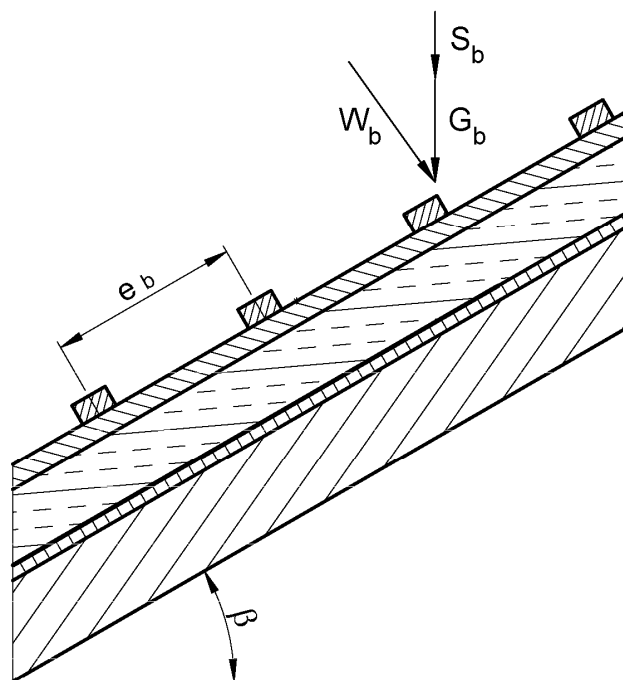

Figure 5.2 Point loads  $F_b$  perpendicular to the battens

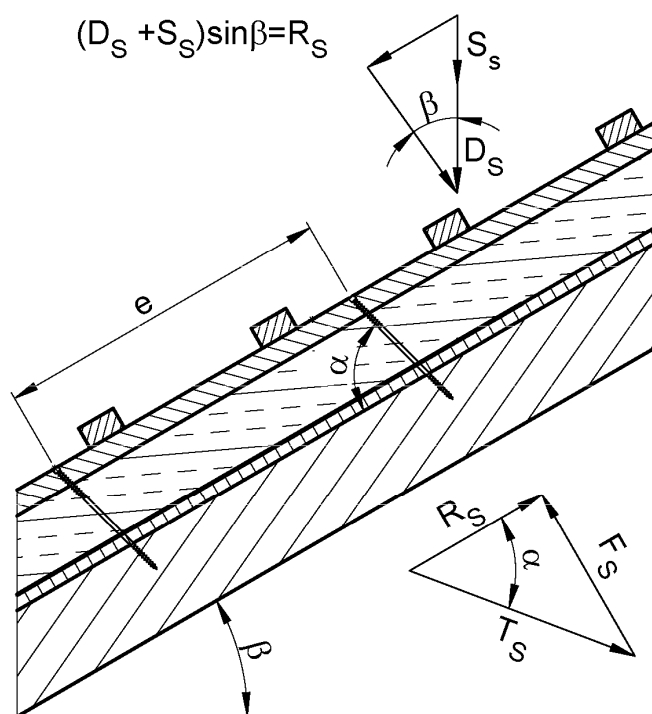

Figure 5.3 Point loads  $F_s$  perpendicular to the battens, load application in the area of the screw heads

Electronic copy of the ETA by DIBt: ETA-11/0190

Würth self-tapping screws	Annex 5
Fastening of thermal insulation material on top of rafters	

### A.5.2.2 Design of the battens

It's assumed that the spacing between the counter battens exceeds the characteristic length  $l_{char}$ .

The characteristic values of the bending stresses are calculated as:

$$M_k = \frac{(F_{b,k} + F_{s,k}) \cdot l_{char}}{4} \quad (5.1)$$

where

$$l_{char} = \text{characteristic length } l_{char} = 4 \sqrt{\frac{4 \cdot EI}{w_{ef} \cdot K}} \quad (5.2)$$

$EI$  = bending stiffness of the batten

$K$  = coefficient of subgrade

$w_{ef}$  = effective width of the thermal insulation material

$F_{b,k}$  = characteristic value of the point loads perpendicular to the battens

$F_{s,k}$  = characteristic value of the point loads perpendicular to the battens, load application in the area of the screw heads

The coefficient of subgrade  $K$  may be calculated from the modulus of elasticity  $E_{HI}$  and the thickness  $t_{HI}$  of the thermal insulation material if the effective width  $w_{ef}$  of the thermal insulation material under compression is known. Due to the load extension in the thermal insulation material the effective width  $w_{ef}$  is greater than the width of the batten or rafter, respectively. For further calculations, the effective width  $w_{ef}$  of the thermal insulation material may be determined according to:

$$w_{ef} = w + t_{HI} / 2 \quad (5.3)$$

where

$w$  = minimum from width of the batten or rafter, respectively

$t_{HI}$  = thickness of the thermal insulation material

$$K = \frac{E_{HI}}{t_{HI}} \quad (5.4)$$

The following condition shall be satisfied:

$$\frac{\sigma_{m,d}}{f_{m,d}} = \frac{M_d}{W \cdot f_{m,d}} \leq 1 \quad (5.5)$$

For the calculation of the section modulus  $W$  the net cross section shall be considered.

The characteristic value of the shear stresses shall be calculated according to:

$$V_k = \frac{(F_{b,k} + F_{s,k})}{2} \quad (5.6)$$

The following condition need to be satisfied:

$$\frac{\tau_d}{f_{v,d}} = \frac{1.5 \cdot V_d}{A \cdot f_{v,d}} \leq 1 \quad (5.7)$$

For the calculation of the cross section area the net cross section shall be considered.

### A.5.2.3 Design of the thermal insulation material

The characteristic value of the compressive stresses in the thermal insulation material shall be calculated according to:

$$\sigma_k = \frac{1.5 \cdot F_{b,k} + F_{s,k}}{2 \cdot l_{char} \cdot w} \quad (5.8)$$

The design value of the compressive stress shall not be greater than 110 % of the compressive stress at 10 % deformation calculated according to EN 826.

Würth self-tapping screws	Annex 5
Fastening of thermal insulation material on top of rafters	

#### A.5.2.4 Design of the screws

The screws are loaded predominantly axial. The characteristic value of the axial tension force in the screw may be calculated from the shear loads of the roof  $R_s$ :

$$T_{S,k} = \frac{R_{S,k}}{\cos \alpha} \quad (5.9)$$

The load-carrying capacity of axially loaded screws is the minimum design value of the axial withdrawal capacity of the threaded part of the screw, the head pull-through capacity of the screw and the tensile capacity of the screw according to Annex 1.

In order to limit the deformation of the screw head for thermal insulation material with thickness over 200 mm or with compressive strength below 0,12 N/mm<sup>2</sup>, respectively, the axial withdrawal capacity of the screws shall be reduced by the factors  $k_1$  and  $k_2$ :

$$F_{ax,\alpha,Rd} = \min \left\{ \frac{f_{ax,d} \cdot d \cdot l_{ef} \cdot k_1 \cdot k_2}{1.2 \cdot \cos^2 \alpha + \sin^2 \alpha} \cdot \left( \frac{\rho_k}{350} \right)^{0.8}; f_{head,d} \cdot d_h^2 \cdot \left( \frac{\rho_k}{350} \right)^{0.8}; \frac{f_{tens,k}}{\gamma_{M2}} \right\} \quad (5.10)$$

where:

- $f_{ax,d}$  design value of the axial withdrawal capacity of the threaded part of the screw [N/mm<sup>2</sup>]
- $d$  outer thread diameter of the screw [mm]
- $l_{ef}$  penetration length of the threaded part of the screw in the rafter,  $l_{ef} \geq 40$  mm
- $\rho_k$  characteristic density of the wood-based member [kg/m<sup>3</sup>], for beech and oak the assumed characteristic density shall not exceed 590 kg/m<sup>3</sup>
- $\alpha$  angle  $\alpha$  between screw axis and grain direction,  $30^\circ \leq \alpha \leq 90^\circ$
- $f_{head,d}$  design value of the head pull-through capacity of the screw [N/mm<sup>2</sup>]
- $d_h$  head diameter [mm]
- $f_{tens,k}$  characteristic tensile capacity of the screw according to Annex 1 [N]
- $\gamma_{M2}$  partial factor according to EN 1993-1-1 or to the particular national Annex
- $k_1$   $\min \{1; 220/t_{HI}\}$
- $k_2$   $\min \{1; \sigma_{10\%}/0,12\}$
- $t_{HI}$  thickness of the thermal insulation material [mm]
- $\sigma_{10\%}$  compressive stress of the thermal insulation material under 10 % deformation [N/mm<sup>2</sup>]

If equation (5.10) is fulfilled, the deflection of the battens does not need to be considered when designing the load-carrying capacity of the screws.

### A.5.3 Alternatively inclined screws and thermal insulation material non in compression

#### A.5.3.1 Mechanical model

Depending on the screw spacing and the arrangement of tensile and compressive screws with different inclinations the battens are loaded by significant bending moments. The bending moments are derived based on the following assumptions:

- The tensile and compressive loads in the screws are determined based on equilibrium conditions from the actions parallel and perpendicular to the roof plane. These actions are constant line loads  $q_{\perp}$  and  $q_{\parallel}$ .
- The screws act as hinged columns supported 10 mm within the batten or rafter, respectively. The effective column length consequently equals the length of the screw between batten and rafter plus 20 mm.

Würth self-tapping screws	Annex 5
Fastening of thermal insulation material on top of rafters	

The batten is considered as a continuous beam with a constant span  $\ell = A + B$ . The compressive screws constitute the supports of the continuous beam while the tensile screws transfer concentrated loads perpendicular to the batten axis.

The screws are predominantly loaded in withdrawal or compression, respectively. The characteristic values of the screw's normal forces are determined based on the loads parallel and perpendicular to the roof plane:

$$\text{Compressive screw: } N_{c,k} = (A + B) \cdot \left( -\frac{q_{\parallel,k}}{\cos \alpha_1 + \sin \alpha_1 / \tan \alpha_2} - \frac{q_{\perp,k} \cdot \sin(90^\circ - \alpha_2)}{\sin(\alpha_1 + \alpha_2)} \right) \quad (5.11)$$

$$\text{Tensile screw: } N_{t,k} = (A + B) \cdot \left( \frac{q_{\parallel,k}}{\cos \alpha_2 + \sin \alpha_2 / \tan \alpha_1} - \frac{q_{\perp,k} \cdot \sin(90^\circ - \alpha_1)}{\sin(\alpha_1 + \alpha_2)} \right) \quad (5.12)$$

- A distance of the screws according to Figure 3.5
- B distance of the alternatively inclined screws according to Figure 3.5
- $q_{\parallel,k}$  characteristic value of the loads parallel to the roof plane
- $q_{\perp,k}$  characteristic value of the loads perpendicular to the roof plane
- $\alpha$  Angle  $\alpha_1$  and  $\alpha_2$  between screw axis and grain direction,  $30^\circ \leq \alpha_1 \leq 90^\circ$ ,  $30^\circ \leq \alpha_2 \leq 90^\circ$

Only screws with full thread or a thread below the head and in the area of the drill tip shall be used.

The bending moments in the batten follow from the constant line load  $q_{\perp}$  and the load components perpendicular to the batten from the tensile screws. The span of the continuous beam is  $(A + B)$ . The characteristic value of the load component perpendicular to the batten from the tensile screw is:

$$F_{ZS,k} = (A + B) \cdot \left( \frac{q_{\parallel,k}}{1 / \tan \alpha_1 + 1 / \tan \alpha_2} - \frac{q_{\perp,k} \cdot \sin(90^\circ - \alpha_1) \cdot \sin \alpha_2}{\sin(\alpha_1 + \alpha_2)} \right) \quad (5.13)$$

A positive value for  $F_{ZS,k}$  means a load towards the rafter, a negative value a load away from the rafter. The system of the continuous beam is shown in Figure 5.5.

The battens or wood-based panels fixed on the rafter shall be supported perpendicular to the load-bearing plane.

Würth self-tapping screws	Annex 5
Fastening of thermal insulation material on top of rafters	

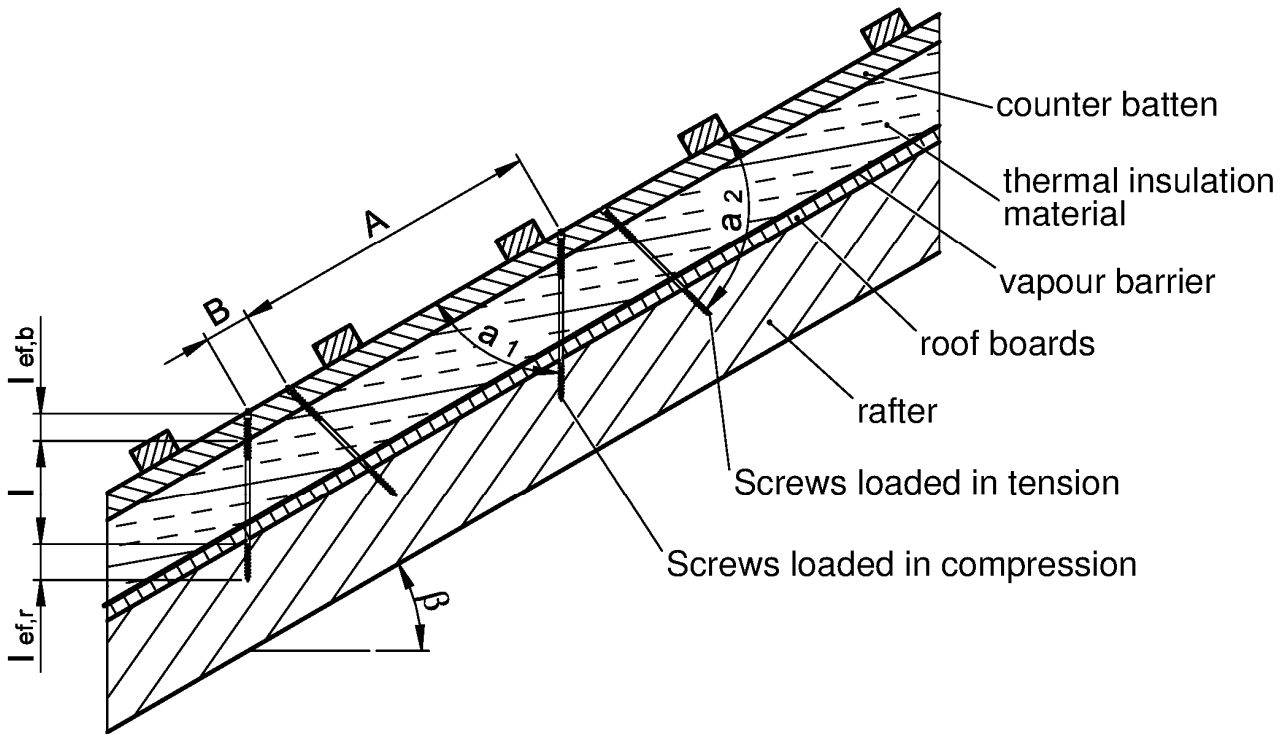

Figure 5.4 Fastening of thermal insulation material on top of rafters - structural system for alternatively inclined screws

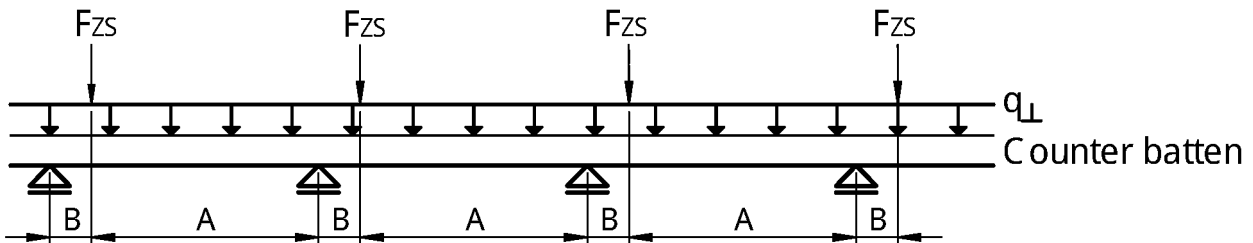

Figure 5.5: Continuous batten under constant line loads from actions on the roof plane  $q_{\perp}$  and concentrated loads from tensile screws  $F_{zs}$

**A.5.3.2 Design of the screws**

The design value of the load-carrying capacity of the screws shall be calculated according to equation (5.14) and (5.15).

Screws loaded in tension:

$$F_{ax,\alpha,Rd} = \min \left\{ \frac{f_{ax,d} \cdot d \cdot l_{ef,b}}{1.2 \cdot \cos^2 \alpha_2 + \sin^2 \alpha_2} \cdot \left( \frac{p_{b,k}}{350} \right)^{0.8}; \frac{f_{ax,d} \cdot d \cdot l_{ef,r}}{1.2 \cdot \cos^2 \alpha_2 + \sin^2 \alpha} \cdot \left( \frac{p_{r,k}}{350} \right)^{0.8}; \frac{f_{tens,k}}{\gamma_{M2}} \right\} \quad (5.14)$$

Electronic copy of the ETA by DIBt: ETA-11/0190

Würth self-tapping screws	Annex 5
Fastening of thermal insulation material on top of rafters	



Screws loaded in compression:

$$F_{ax,\alpha,Rd} = \min \left\{ \frac{f_{ax,d} \cdot d \cdot l_{ef,b}}{1.2 \cdot \cos^2 \alpha_1 + \sin^2 \alpha_1} \cdot \left( \frac{\rho_{b,k}}{350} \right)^{0.8}; \frac{f_{ax,d} \cdot d \cdot l_{ef,r}}{1.2 \cdot \cos^2 \alpha_1 + \sin^2 \alpha_1} \cdot \left( \frac{\rho_{r,k}}{350} \right)^{0.8}; \frac{\kappa_c \cdot N_{pl,k}}{\gamma_{M1}} \right\} \quad (5.15)$$

where:

- $f_{ax,d}$  design value of the axial withdrawal capacity of the threaded part of the screw [N/mm<sup>2</sup>]
- $d$  outer thread diameter of the screw [mm]
- $l_{ef,b}$  penetration length of the threaded part of the screw in the batten [mm]
- $l_{ef,r}$  penetration length of the threaded part of the screw in the rafter,  $l_{ef} \geq 40$  mm
- $\rho_{b,k}$  characteristic density of the batten [kg/m<sup>3</sup>], for beech and oak the assumed characteristic density shall not exceed 590 kg/m<sup>3</sup>
- $\rho_{r,k}$  characteristic density of the rafter [kg/m<sup>3</sup>], for beech and oak the assumed characteristic density shall not exceed 590 kg/m<sup>3</sup>
- $\alpha$  angle  $\alpha_1$  or  $\alpha_2$  between screw axis and grain direction,  $30^\circ \leq \alpha_1 \leq 90^\circ$ ,  $30^\circ \leq \alpha_2 \leq 90^\circ$
- $f_{tens,k}$  characteristic tensile capacity of the screw according to Annex 1 [N]
- $\gamma_{M1}, \gamma_{M2}$  partial factor according to EN 1993-1-1 or to the particular national Annex
- $\kappa_c \cdot N_{pl,k}$  Buckling capacity of the screw according to table 5.1 [N]

Würth self-tapping screws	Annex 5
Fastening of thermal insulation material on top of rafters	

Table 5.1 Characteristic load-carrying capacity of the screws  $\kappa_c \cdot N_{pl,k}$  in kN

Free screw length $l$ between batten and rafter [mm]	ASSY plus VG					ASSY Isotop
	Outer thread diameter $d$ [mm]					
	6.0	8.0	10.0	12.0	14.0	8.0/ 10.0
	$\kappa_c \cdot N_{pl,k}$ [kN]					
≤ 100	1.12	3.26	8.24	13.30	21.8	10.1
120	0.85	2.48	6.37	10.40	17.4	8.30
140	0.66	1.95	5.06	8.32	14.1	6.84
160	0.53	1.57	4.10	6.78	11.6	5.70
180	0.43	1.17	3.39	5.63	9.61	4.79
200	-	1.08	2.86	4.74	8.14	4.08
220	-	0.91	2.43	4.05	6.96	3.51
240	-	0.78	2.09	3.50	6.03	3.04
260	-	0.68	1.81	3.05	5.25	2.67
280	-	0.59	1.60	2.68	4.65	2.35
300	-	0.53	1.40	2.37	4.11	2.10
320	-	0.47	1.25	2.10	3.67	1.88
340	-	0.42	1.12	1.90	3.30	1.69
360	-	0.37	1.01	1.71	2.98	1.53
380	-	0.34	0.92	1.55	2.70	1.45
400	-	0.31	0.83	1.42	2.46	1.26
420	-	0.28	0.77	1.30	2.25	1.16
440	-	0.26	0.70	1.18	2.06	1.06
460	-	0.24	0.65	1.10	1.91	0.99
480	-	0.22	0.59	1.01	1.77	0.91

Würth self-tapping screws	Annex 5
Fastening of thermal insulation material on top of rafters	

1) ASSY (all kinds without ASSY plus VG and ASSY Isotop)

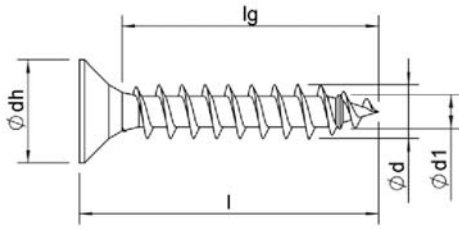

Full thread without drilling tip

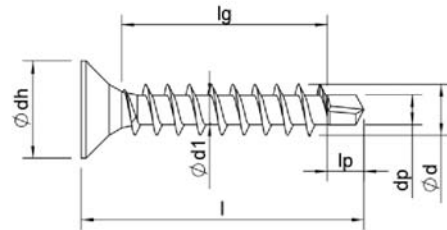

Full thread with drilling tip

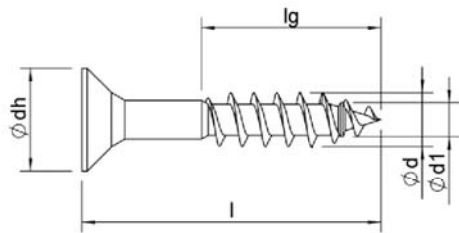

Partial thread without drilling tip

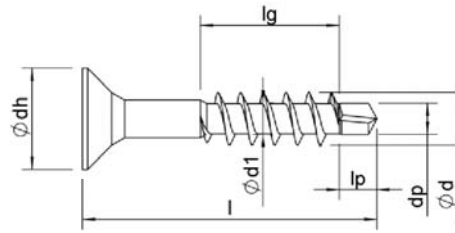

Partial thread with drilling tip

2) All ASSY screws can be like on the drawing (I) or without thread in the middle of screw (II) or without thread below head (III) or in combination (IV). The thread lengths can be manufactured to customer specific within  $4 \times d$  and  $lg$  max..

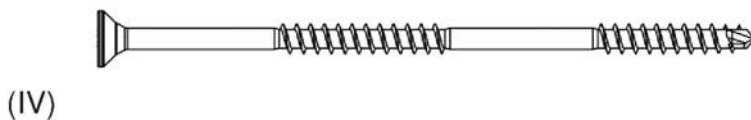
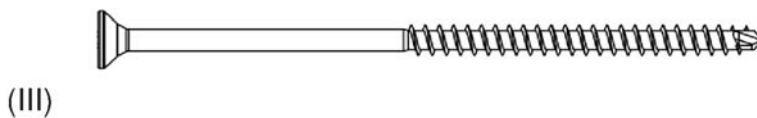
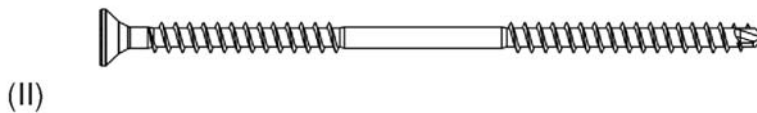
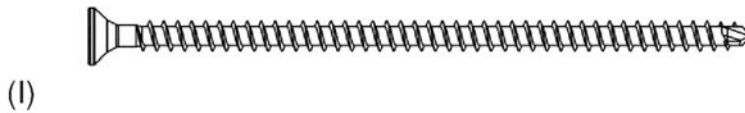

Possible surface coatings: blank, brass-plated, nickel-plated, browned, black chromated, black zinc chromated, yellow chromated, blue passivated, zinc-nickel coating, zinc plate, rusper, holly or partially painted, hot galvanized, aluminum coating

Würth self-tapping screws

6.1 Drawings of ASSY screws

Annex 6

### Head types for d = 3.0 mm

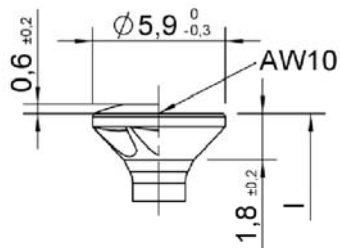

Countersunk head – design: with and without raise, with and without milling pockets

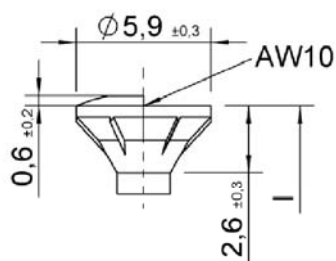

Countersunk head with cutter ribs - design with and without raise

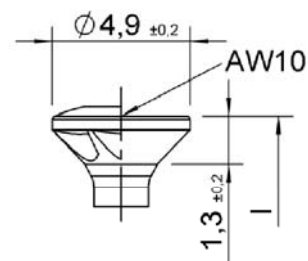

Piano hinge head - design: with and without raise, with and without milling pockets

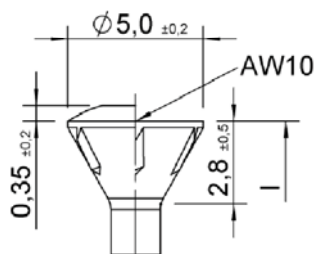

Woodwork head – design with and without raise

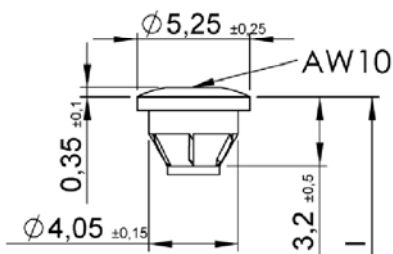

Top head – design with and without raise

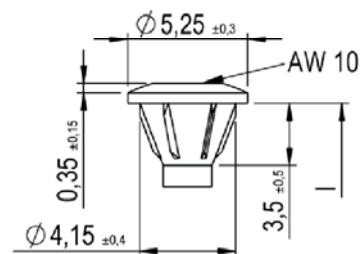

Top head II – design with and without raise

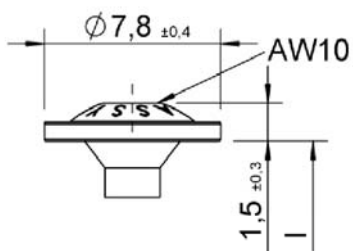

Back panel screw head

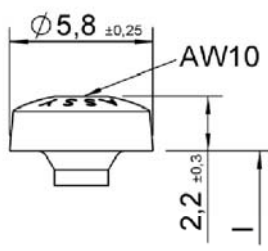

Pan head

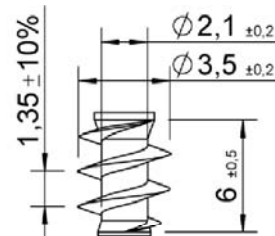

Underhead thread

Würth self-tapping screws

6.2 ASSY and ASSY plus screws, carbon steel

Annex 6

English translation prepared by DIBt

**Thread types d = 3.0 mm**

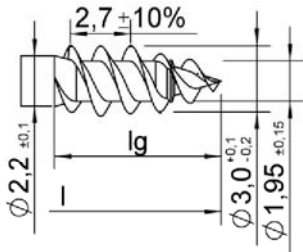

ASSY double – threaded  
Design with and without ring respectively mating thread

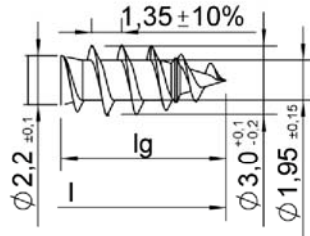

ASSY single - threaded  
Design with and without ring respectively mating thread

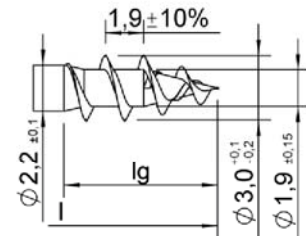

ASSY coarse thread  
Design with and without ring respectively mating thread

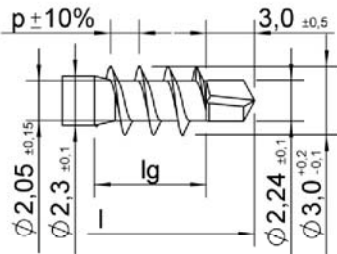

ASSY plus  
Design with p = 1.35 and 1.9

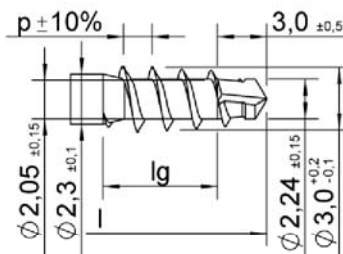

ASSY plus special  
Design with p = 1.35 and 1.9

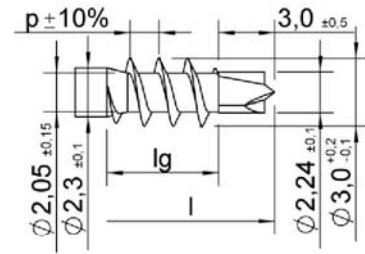

ASSY plus 3.0  
Design with p = 1.35 and 1.9

**Lengths for d = 3.0 mm**

l	lg
+1.0	+1.0
- 2.0	- 2.0
13	12
...	...
50	49

Screws without thread in the middle of screw or without thread below head or in combination of both are possible (see page 1 of this Annex). The thread lengths can be manufactured to customer specific within lg min and lg max.

All dimensions in mm.

Würth self-tapping screws

6.2 ASSY and ASSY plus screws, carbon steel

Annex 6

**Head types for d = 3.5 mm**

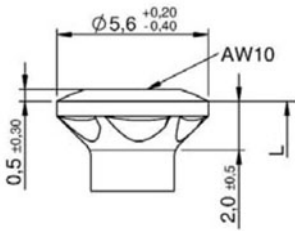

Countersunk head – design: with and without raise, with and without milling pockets

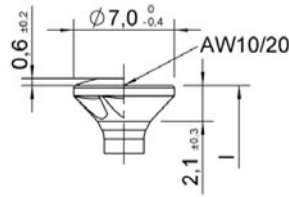

Countersunk head – design: with and without raise, with and without milling pockets

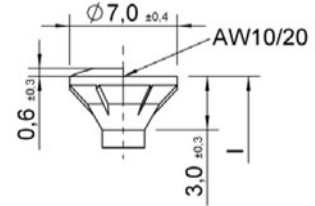

Countersunk head with cutter ribs - design with and without raise

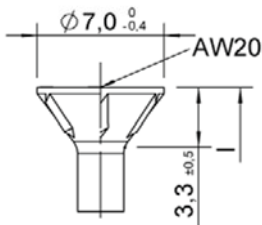

75° head – design: with and without raise, with and without milling pockets or raise

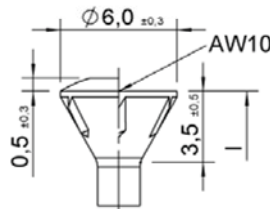

Woodwork head – design with and without raise

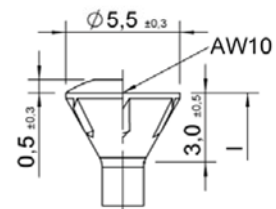

Woodwork head – design with and without raise

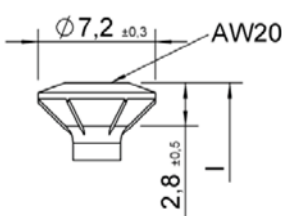

FBS-head

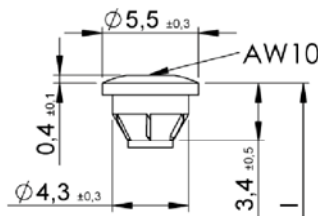

Top head – design with and without raise

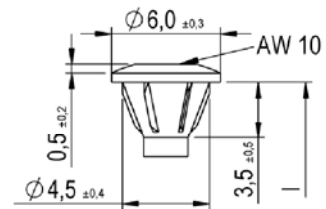

Top head II – design with and without raise

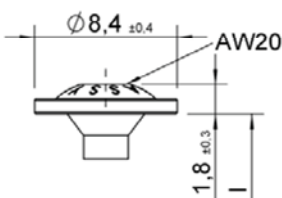

Back panel screw head

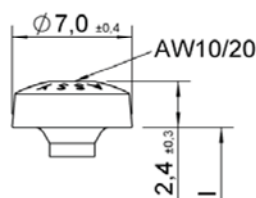

Pan head

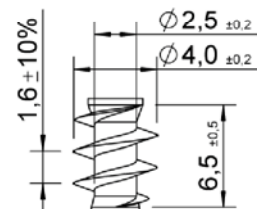

Underhead thread

Würth self-tapping screws

6.2 ASSY and ASSY plus screws, carbon steel

Annex 6



**Thread types d = 3.5 mm**

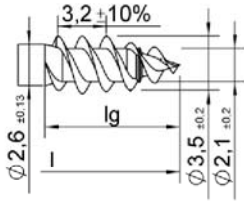

**ASSY double – threaded**  
Design with and without  
ring respectively mating  
thread

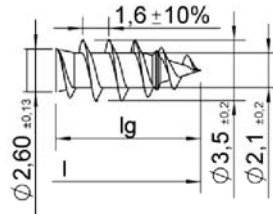

**ASSY single - threaded**  
Design with and without  
ring respectively mating  
thread

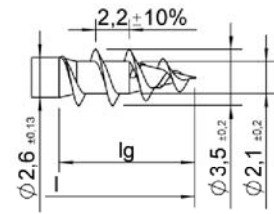

**ASSY coarse thread**  
Design with and without  
ring respectively mating  
thread

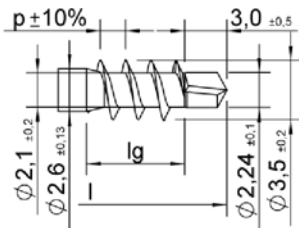

**ASSY plus**  
Design with p = 1.6 and  
2.2

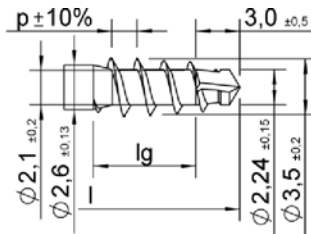

**ASSY plus special**  
Design with p = 1.6 and  
2.2

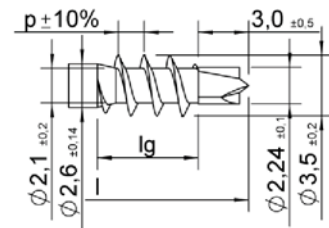

**ASSY plus 3.0**  
Design with p = 1.6 and 2.2

**Lengths for d = 3.5 mm**

l	lg
+1.0	+1.0
- 2.0	- 2.0
16	14
...	...
50	48

Screws without thread in the middle of screw or without thread below head or in combination of both are possible (see page 1 of this Annex). The thread lengths can be manufactured to customer specific within lg min and lg max.

All dimensions in mm.

Würth self-tapping screws

6.2 ASSY and ASSY plus screws, carbon steel

Annex 6

Head types for  $d = 4.0$  mm

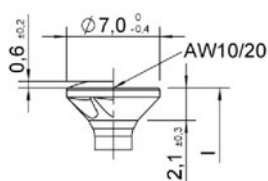

Countersunk head – design: with and without raise, with and without milling pockets

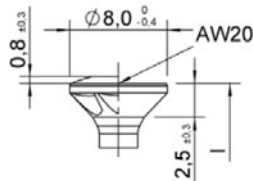

Countersunk head – design: with and without raise, with and without milling pockets

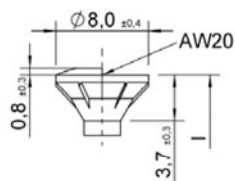

Countersunk head with cutter ribs - design with and without raise

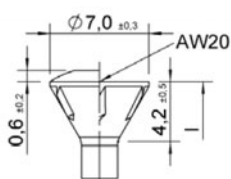

Woodwork head – design with and without raise

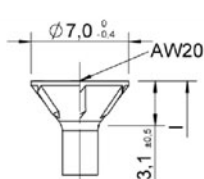

Countersunk head 75° – design with and without raise

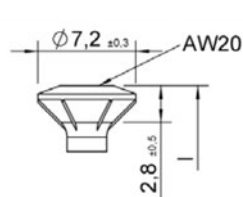

FBS-head

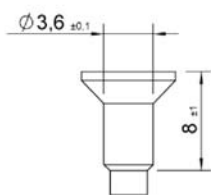

Alternatively at countersunk heads: modification of the shank at drilled head

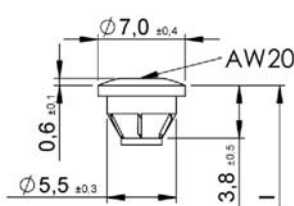

Top head – design with and without raise

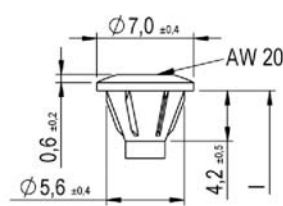

Top head II – design with and without raise

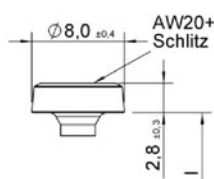

Elmo head

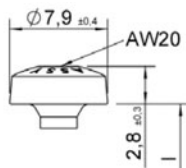

Pan head

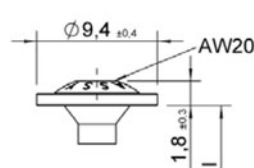

Back panel screw head

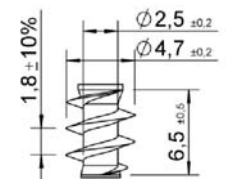

Underhead thread

Würth self-tapping screws

6.2 ASSY and ASSY plus screws, carbon steel

Annex 6



### Thread types d = 4.0 mm

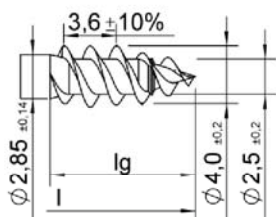

**ASSY double – threaded**  
Design with and without  
ring respectively mating  
thread

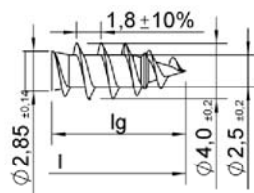

**ASSY single - threaded**  
Design with and without  
ring respectively mating  
thread

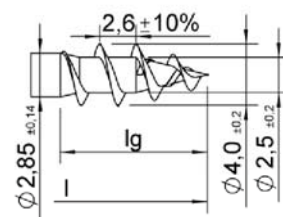

**ASSY coarse thread**  
Design with and without  
ring respectively mating  
thread

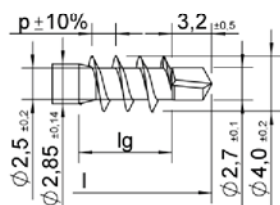

**ASSY plus**  
Design with p = 1.8 and  
2.6

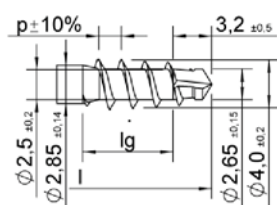

**ASSY plus special**  
Design with p = 1.8 and  
2.6

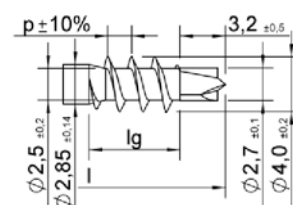

**ASSY plus 3.0**  
Design with p = 1.8 and 2.6

### Lengths for d = 4.0 mm

l	lg
+1.0	+1.0
- 2.0	- 2.0
18	16
...	...
70	68

Screws without thread in the middle of screw or without thread below head or in combination of both are possible (see page 1 of this Annex). The thread lengths can be manufactured to customer specific within lg min and lg max.

All dimensions in mm.

Würth self-tapping screws

6.2 ASSY and ASSY plus screws, carbon steel

Annex 6

**Head types for d = 4.5 mm**

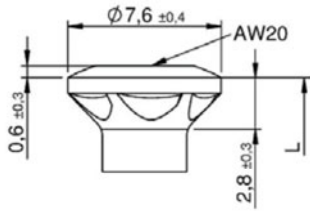

Countersunk head – design: with and without raise, with and without milling pockets

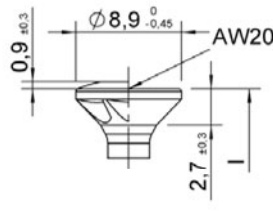

Countersunk head – design: with and without raise, with and without milling pockets

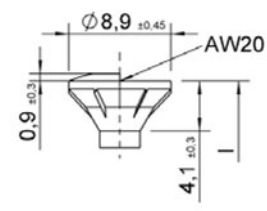

Countersunk head with cutter ribs - design with and without raise

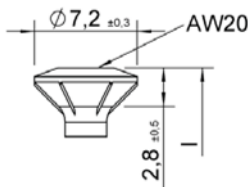

FBS-head

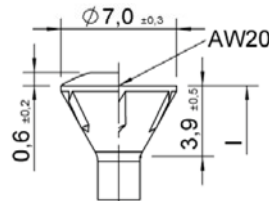

Woodwork head – design with and without raise

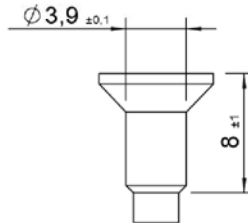

Alternatively at countersunk heads: modification of the shank at drilled head

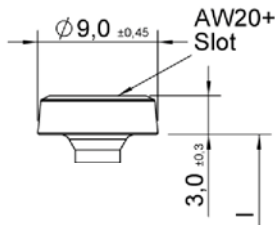

Elmo head

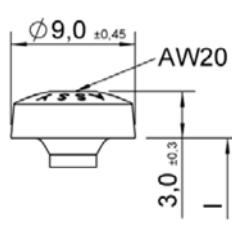

Pan head

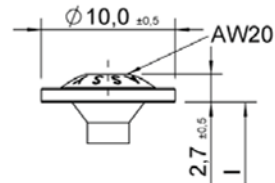

Back panel screw head

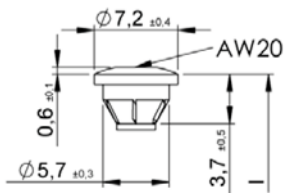

Top head – design with and without raise

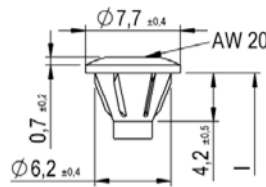

Top head II – design with and without raise

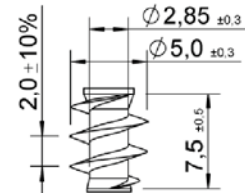

Underhead thread

Würth self-tapping screws

6.2 ASSY and ASSY plus screws, carbon steel

Annex 6

**Thread types d = 4.5 mm**

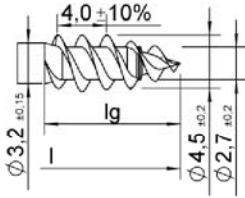

**ASSY double – threaded**  
Design with and without ring respectively mating thread

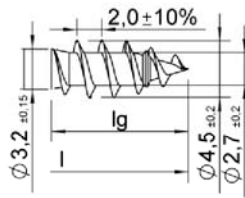

**ASSY single - threaded**  
Design with and without ring respectively mating thread

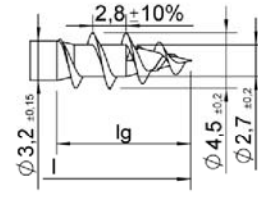

**ASSY coarse thread**  
Design with and without ring respectively mating thread

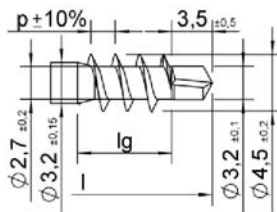

**ASSY plus**  
Design with p = 2,0 and 2.8

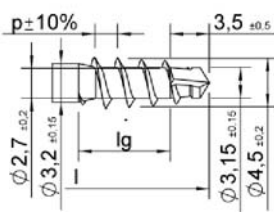

**ASSY plus special**  
Design with p = 2.0 and 2.8

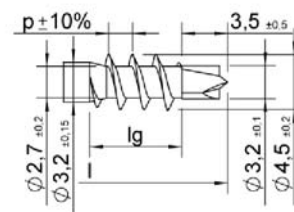

**ASSY plus 3.0**  
Design with p = 2,0 and 2.8

**Lengths for d = 4.5 mm**

l	lg
+1.0	+1.0
- 2.0	- 2.0
20	18
...	...
100	78

Screws without thread in the middle of screw or without thread below head or in combination of both are possible (see page 1 of this Annex). The thread lengths can be manufactured to customer specific within lg min and lg max.

All dimensions in mm.

Würth self-tapping screws

6.2 ASSY and ASSY plus screws, carbon steel

Annex 6

Head types for d = 5.0 mm

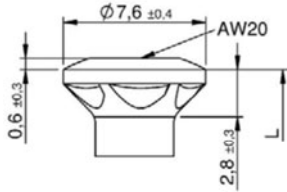

Countersunk head – design: with and without raise, with and without milling pockets

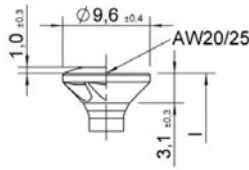

Countersunk head – design: with and without raise, with and without milling pockets

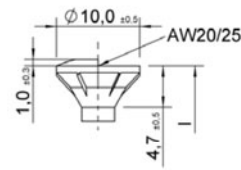

Countersunk head with cutter ribs - design with and without raise

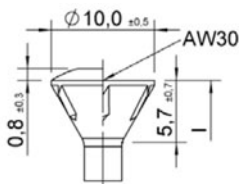

Woodwork head – design with and without raise

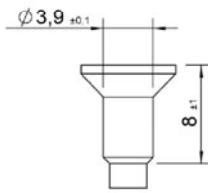

Alternatively at countersunk heads: modification of the shank at drilled head

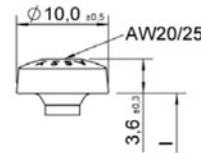

Pan head

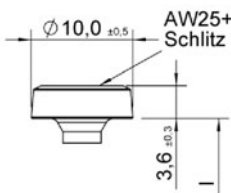

Elmo head

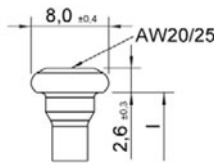

Joist hanger screw head

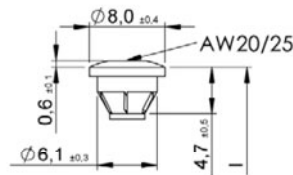

Top head – design with and without raise

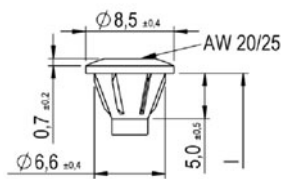

Top head II – design with and without raise

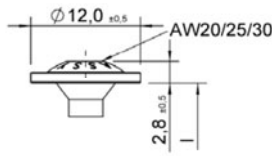

Large washer head

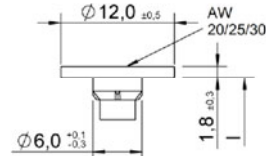

Large washer head II – design with and without raise

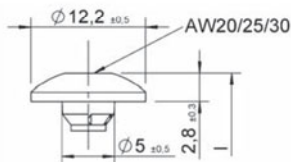

Truss head - design: with and without cutter ribs

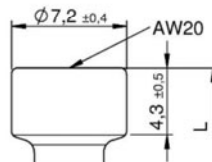

Cylinder head

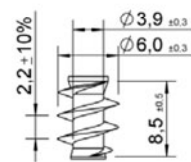

Underhead thread

Würth self-tapping screws

6.2 ASSY and ASSY plus screws, carbon steel

Annex 6

**Thread types d = 5.0 mm**

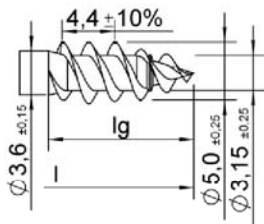

**ASSY double – threaded**  
Design with and without  
ring respectively mating  
thread

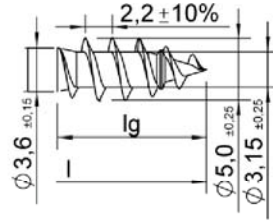

**ASSY single - threaded**  
Design with and without  
ring respectively mating  
thread

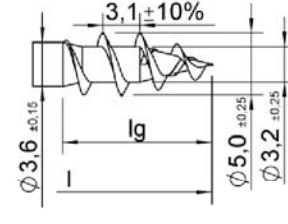

**ASSY coarse thread**  
Design with and without  
ring respectively mating  
thread

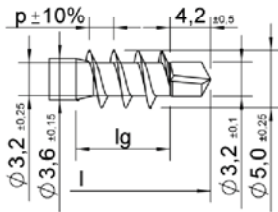

**ASSY plus**  
Design with p = 2.2 und  
3.1

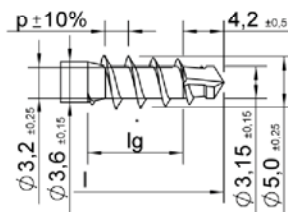

**ASSY plus special**  
Design with p = 2.2 und  
3.1

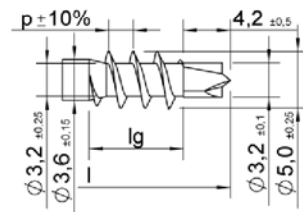

**ASSY plus 3.0**  
Design with p = 2.2 und 3.1

**Lengths for d = 5.0 mm**

l	lg	Shank cutter at ASSY partial thread	Shank cutter at ASSY plus / 3.0 / special partial thread
+1.0 - 2.5	+1.0 - 2.0		
22	20	up to L = 90: optional	over all lengths optional
...	...	over L = 90: yes	
120	90		

Shank cutter

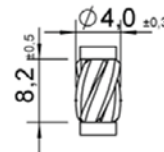

Screws without thread in the middle of screw or without thread below head or in combination of both are possible (see page 1 of this Annex). The thread lengths can be manufactured to customer specific within lg min and lg max.

All dimensions in mm.

Würth self-tapping screws

6.2 ASSY and ASSY plus screws, carbon steel

Annex 6



Head types for  $d = 6.0 \text{ mm}$

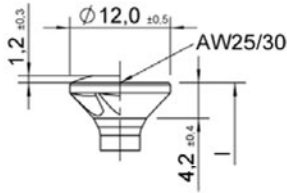

Countersunk head – design: with and without raise, with and without milling pockets

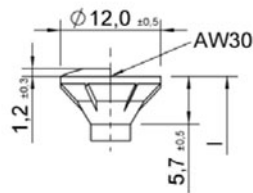

Countersunk head with cutter ribs - design with and without raise

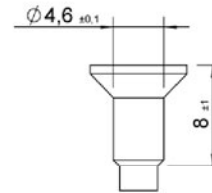

Alternatively at countersunk heads: modification of the shank at drilled head

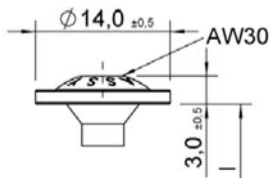

Large washer head

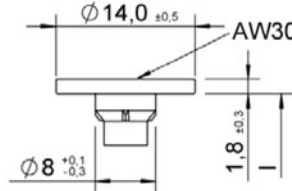

Large washer head II – design with and without raise

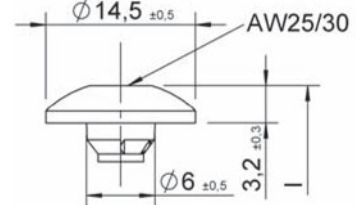

Truss head - design: with and without cutter ribs

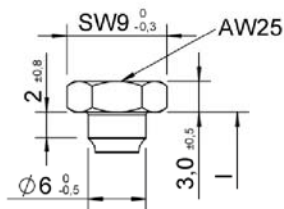

Kombi hexagonal head

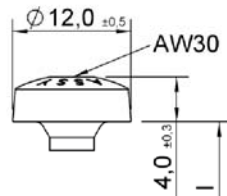

Pan head

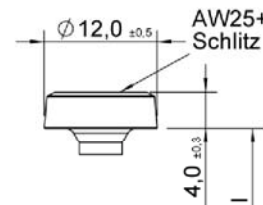

Elmo head

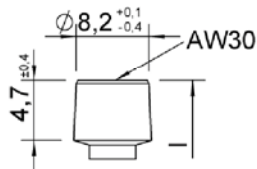

Cylinder head

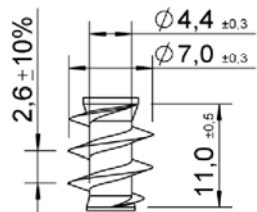

Underhead thread

Würth self-tapping screws

6.2 ASSY and ASSY plus screws, carbon steel

Annex 6

English translation prepared by DIBt

**Thread types d = 6.0 mm**

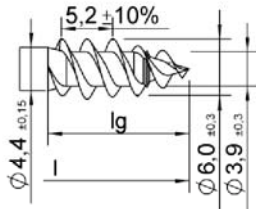

**ASSY double – threaded**  
Design with and without ring respectively mating thread

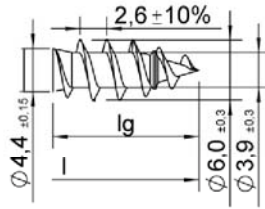

**ASSY single - threaded**  
Design with and without ring respectively mating thread

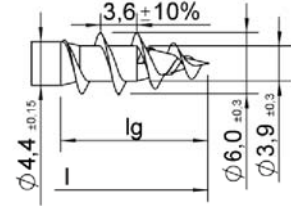

**ASSY coarse thread**  
Design with and without ring respectively mating thread

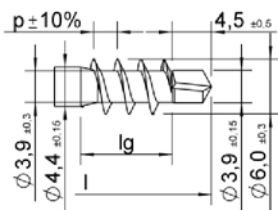

**ASSY plus**  
Design with p = 2.6 und 3.6

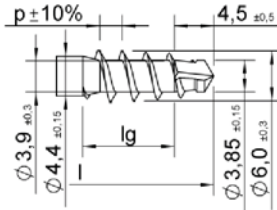

**ASSY plus special**  
Design with p = 2.6 und 3.6

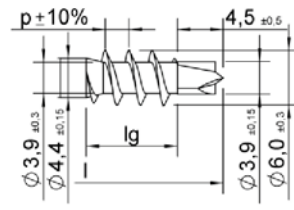

**ASSY plus 3.0**  
Design with p = 2.6 und 3.6

**Lengths for d = 6.0 mm**

l	lg	Shank cutter at ASSY partial thread	Shank cutter at ASSY plus / 3.0 / special partial thread
+1.0 - 3.5	+1.0 - 2.5		
25	24	up to l =120: optional	over all lengths optional
47...	...	over l =120: yes	
300	180		

Shank cutter

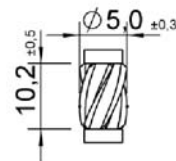

Screws without thread in the middle of screw or without thread below head or in combination of both are possible (see page 1 of this Annex). The thread lengths can be manufactured to customer specific within lg min and lg max.

All dimensions in mm.

Würth self-tapping screws

6.2 ASSY and ASSY plus screws, carbon steel

Annex 6

### Head types for d = 7.0 mm

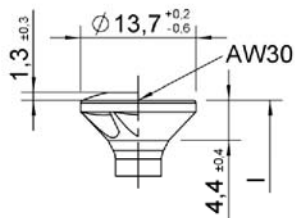

Countersunk head – design: with and without raise, with and without milling pockets

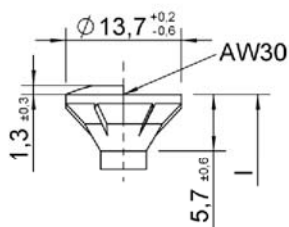

Countersunk head with cutter ribs - design with and without raise

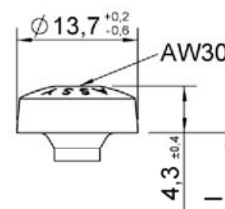

Pan head

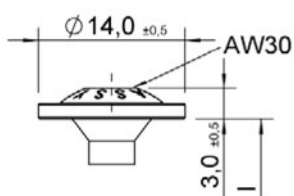

Large washer head

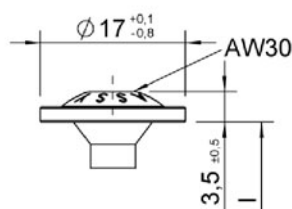

Large washer head

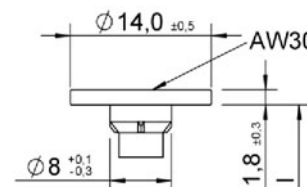

Large washer head II – design with and without raise

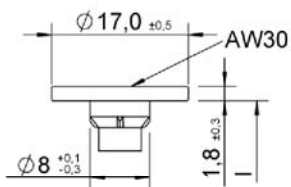

Large washer head II – design with and without raise

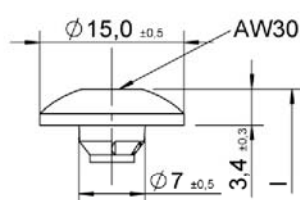

Truss head - design: with and without cutter ribs

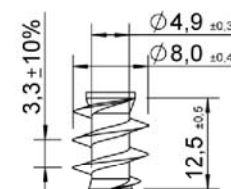

Underhead thread

Würth self-tapping screws

6.2 ASSY and ASSY plus screws, carbon steel

Annex 6



### Thread types d = 7.0 mm

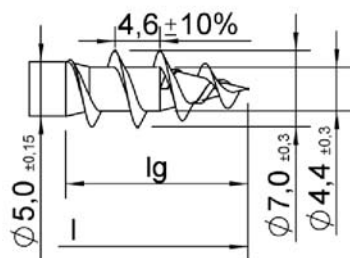

ASSY coarse thread

Design with and without  
ring respectively mating  
thread

### Lengths for d = 7.0 mm

l	lg	Shank cutter at ASSY partial thread
+1.0 - 3.5	+1.0 - 2.5	
30	28	up to L = 120: optional
...	...	over L = 120: yes
300	210	

Shank cutter

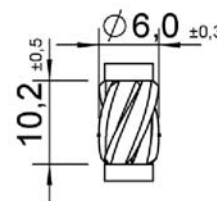

Screws without thread in the middle of screw or without thread below head or in combination of both are possible (see page 1 of this Annex). The thread lengths can be manufactured to customer specific within lg min and lg max.

All dimensions in mm.

### Head types for d = 8.0 mm

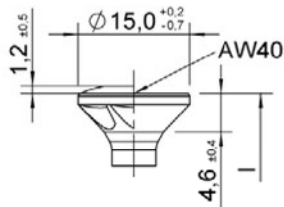

Countersunk head – design: with and without raise, with and without milling pockets

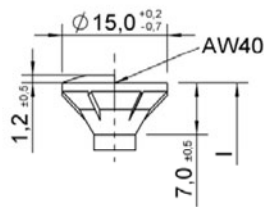

Countersunk head with cutter ribs - design with and without raise

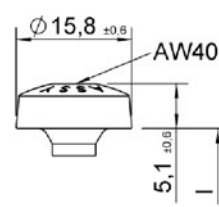

Pan head

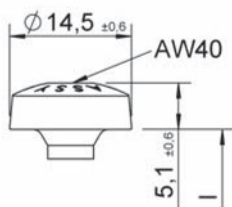

Pan head

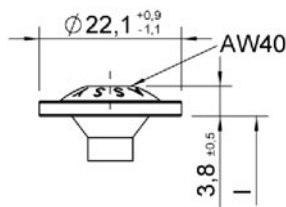

Large washer head

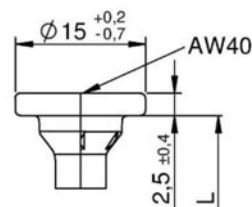

Large washer head II – design with and without raise

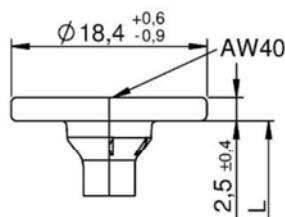

Large washer head II – design with and without raise

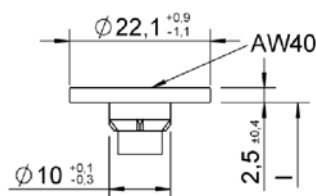

Large washer head II – design with and without raise

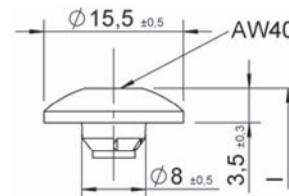

Truss head - design: with and without cutter ribs

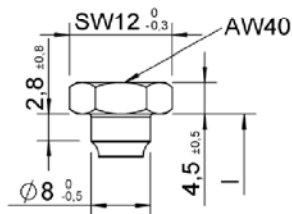

Kombi hexagonal head

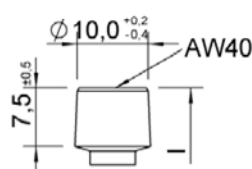

Cylinder head

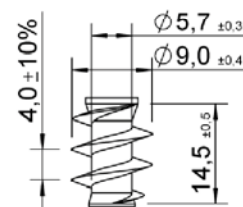

Underhead thread

Würth self-tapping screws

6.2 ASSY and ASSY plus screws, carbon steel

Annex 6

### Thread types d = 8.0 mm

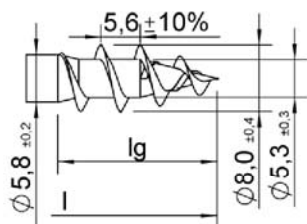

ASSY coarse thread  
Design with and without  
ring respectively mating  
thread

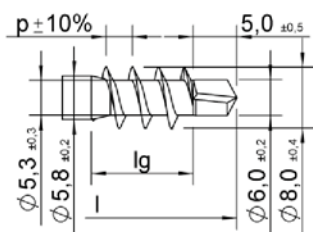

ASSY plus  
Design with p = 5.6

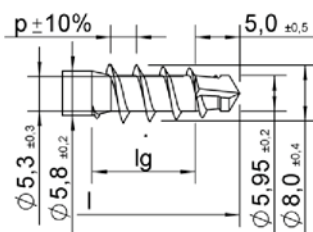

ASSY plus special  
Design with p = 5.6

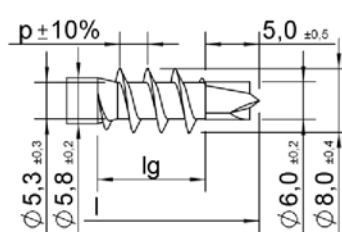

ASSY plus 3.0  
Design with p = 5.6

### Lengths for d = 8.0 mm

l	lg	Shank cutter at ASSY partial thread	Shank cutter at ASSY plus / 3.0 / special partial thread
+1.0 - 5.0	+1.0 - 2.5		
35	32	up to L = 200: optional	over all lengths optional
...	...	over L = 200: yes	
800	240		

Shank cutter

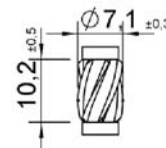

Screws without thread in the middle of screw or without thread below head or in combination of both are possible (see page 1 of this Annex). The thread lengths can be manufactured to customer specific within lg min and lg max.

All dimensions in mm.

Würth self-tapping screws

6.2 ASSY and ASSY plus screws, carbon steel

Annex 6

Head types for  $d = 10.0 \text{ mm}$

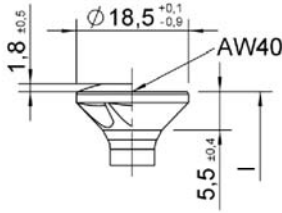

Countersunk head – design: with and without raise, with and without milling pockets

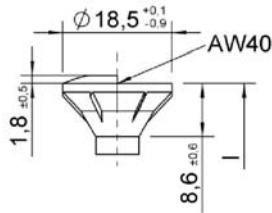

Countersunk head with cutter ribs - design with and without raise

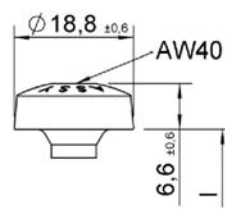

Pan head

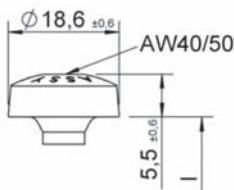

Pan head

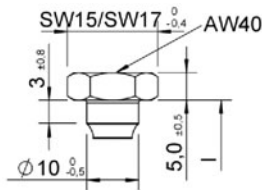

Kombi hexagonal head

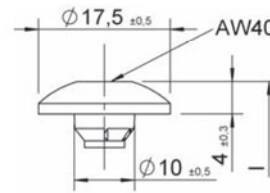

Truss head - design: with and without cutter ribs

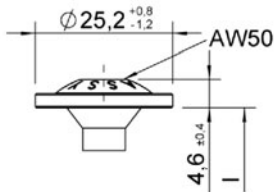

Large washer head

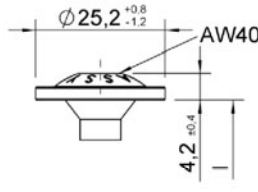

Large washer head

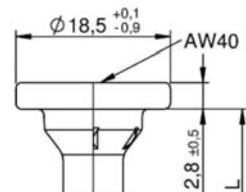

Large washer head II – design with and without raise

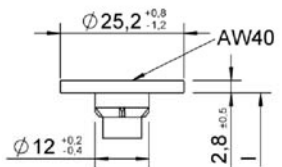

Large washer head II – design with and without raise

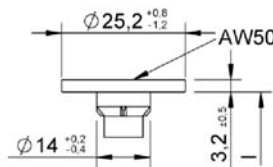

Large washer head II – design with and without raise

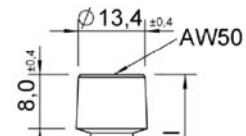

Cylinder head

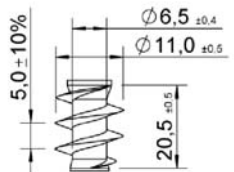

Underhead thread

Würth self-tapping screws

6.2 ASSY and ASSY plus screws, carbon steel

Annex 6

### Thread types d = 10.0 mm

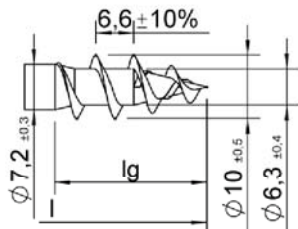

ASSY coarse thread  
Design with and without  
ring respectively mating  
thread

### Lengths for d = 10.0 mm

l +1.0 - 5.0	lg +1.0 - 3.0	Shank cutter at ASSY partial thread
45	40	up to L = 200: optional
...	...	over L = 200: yes
1000	300	

Shank cutter

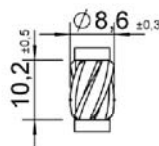

Screws without thread in the middle of screw or without thread below head or in combination of both are possible (see page 1 of this Annex). The thread lengths can be manufactured to customer specific within lg min and lg max.

All dimensions in mm.

Head types for  $d = 12.0$  mm

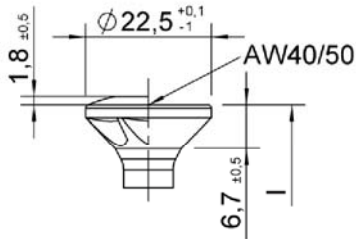

Countersunk head – design: with and without raise, with and without milling pockets

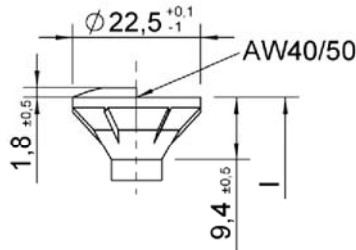

Countersunk head with cutter ribs - design with and without raise

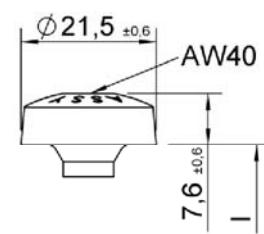

Pan head

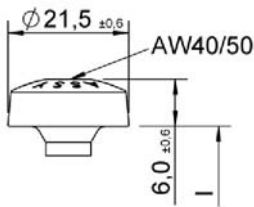

Pan head

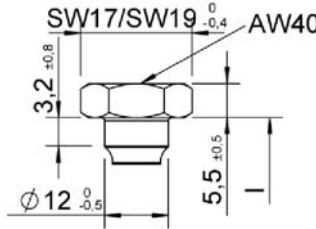

Kombi hexagonal head

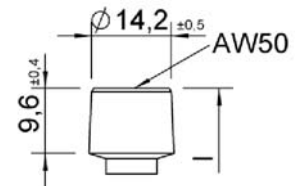

Cylinder head

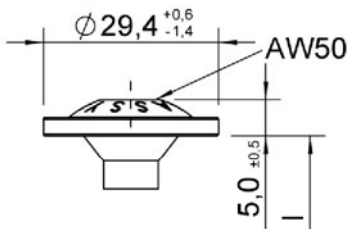

Large washer head

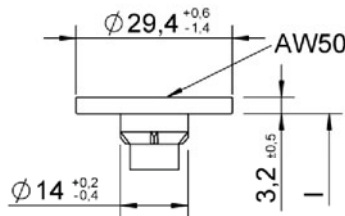

Large washer head II – design with and without raise

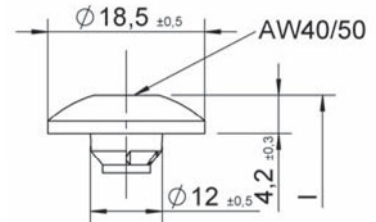

Truss head - design: with and without cutter ribs

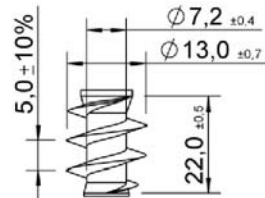

Underhead thread

Würth self-tapping screws

6.2 ASSY and ASSY plus screws, carbon steel

Annex 6



### Thread types d = 12.0 mm

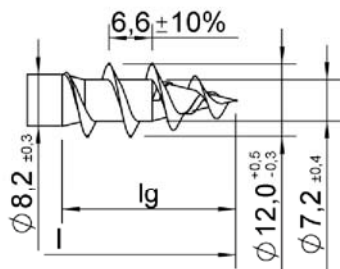

ASSY coarse thread

Design with and without  
ring respectively mating  
thread

### Lengths for d = 12.0 mm

l +1.0 - 5.0	lg +1.0 - 3.0	Shank cutter at ASSY partial thread
60	50	up to L = 200: optional
...	...	over L = 200: yes
520	360	

Shank cutter

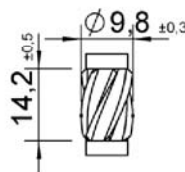

Screws without thread in the middle of  
screw or without thread below head or  
in combination of both are possible  
(see page 1 of this Annex). The thread  
lengths can be manufactured to  
customer specific within lg min and lg  
max.

All dimensions in mm.

Würth self-tapping screws

6.2 ASSY and ASSY plus screws, carbon steel

Annex 6

Head types for d = 3.0 mm

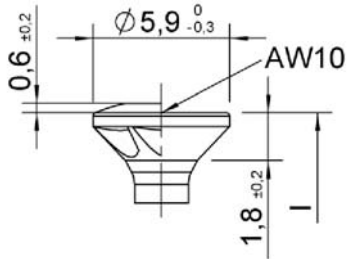

Countersunk head – design: with and without raise, with and without milling pockets

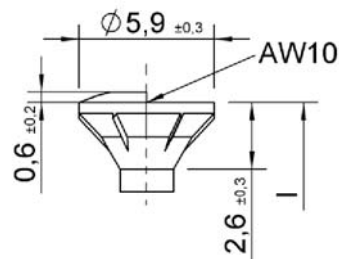

Countersunk head with cutter ribs - design with and without raise

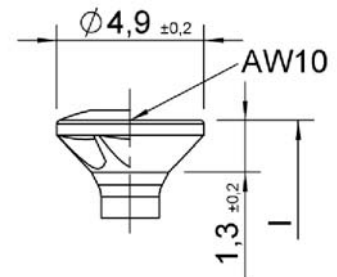

Piano hinge head - design: with and without raise, with and without milling pockets

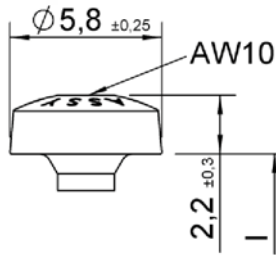

Pan head

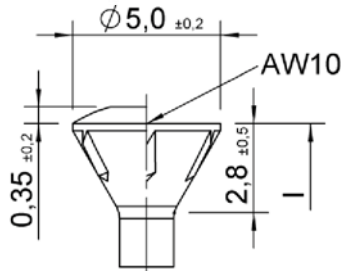

Woodwork head – design with and without raise

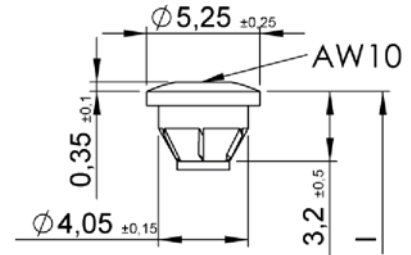

Top head – design with and without raise

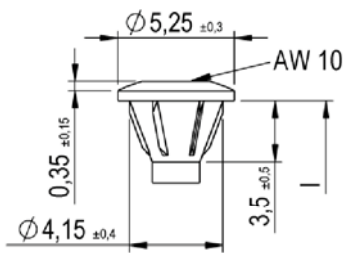

Top head II – design with and without raise

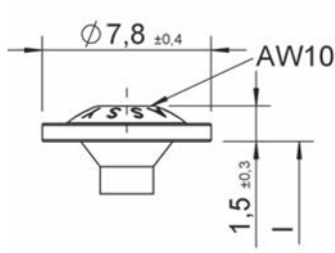

Back panel screw head

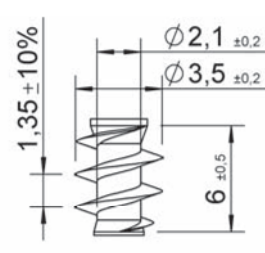

Underhead thread

Würth self-tapping screws

6.3 ASSY screws, stainless steel

Annex 6



### Thread types d = 3.0 mm

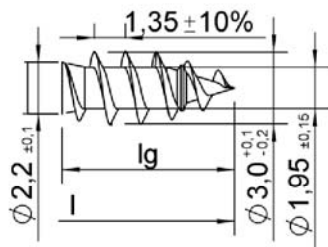

ASSY single - threaded

### Lengths for d = 3.0 mm

l	lg
+1.0	+1.0
-2.0	-2.0
13	12
...	...
50	49

Screws without thread in the middle of screw or without thread below head or in combination of both are possible (see page 1 of this Annex). The thread lengths can be manufactured to customer specific within  $l_g$  min and  $l_g$  max.

All dimensions in mm.

Würth self-tapping screws

6.3 ASSY screws, stainless steel

Annex 6

Head types for d = 3.5 mm

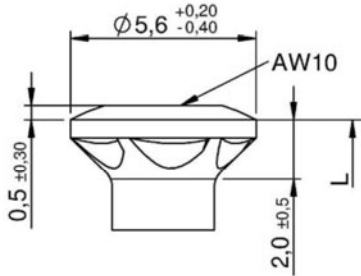

Countersunk head – design: with and without raise, with and without milling pockets

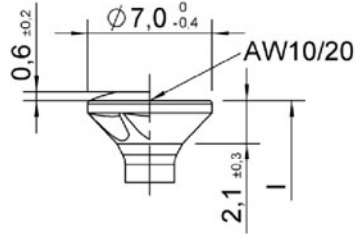

Countersunk head – design: with and without raise, with and without milling pockets

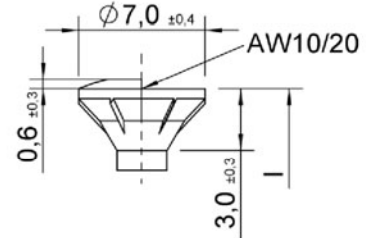

Countersunk head with cutter ribs - design with and without raise

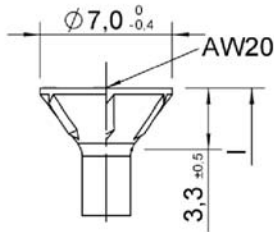

75° head – design with and without cutter ribs, with and without raise

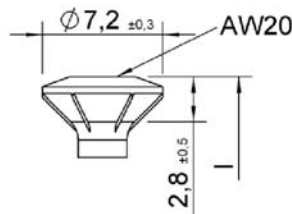

FBS-head

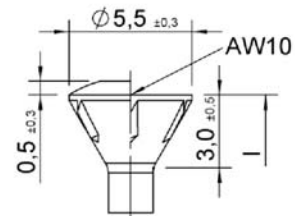

Woodwork head – design with and without raise

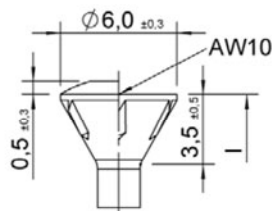

Woodwork head – design with and without raise

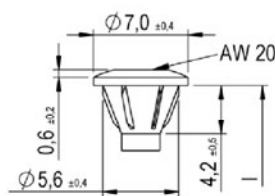

Top head II – design with and without raise

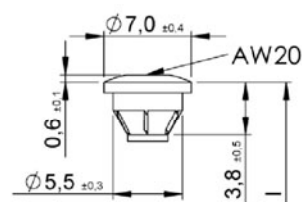

Top head – design with and without raise

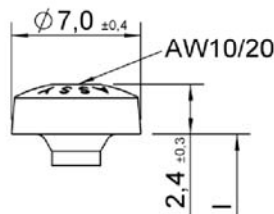

Pan head

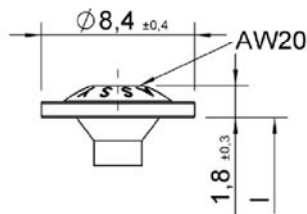

Back panel screw head

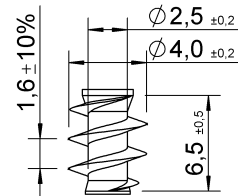

Underhead thread

Würth self-tapping screws

6.3 ASSY screws, stainless steel

Annex 6

### Thread types d = 3.5 mm

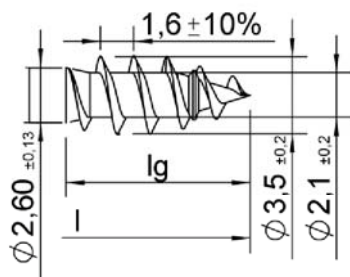

ASSY single - threaded

### Lengths for d = 3.5 mm

l	lg
+1.0	+1.0
- 2.0	- 2.0
16	14
...	...
50	48

Screws without thread in the middle of screw or without thread below head or in combination of both are possible (see page 1 of this Annex). The thread lengths can be manufactured to customer specific within lg min and lg max.

All dimensions in mm.

Würth self-tapping screws

6.3 ASSY screws, stainless steel

Annex 6

**Head types for d = 4.0 mm**

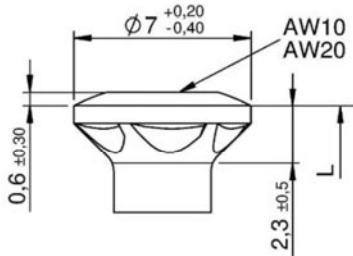

Countersunk head – design: with and without raise, with and without milling pockets

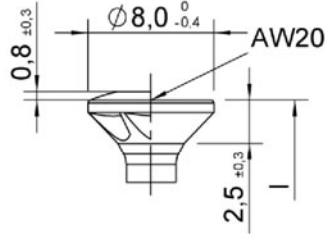

Countersunk head – design: with and without raise, with and without milling pockets

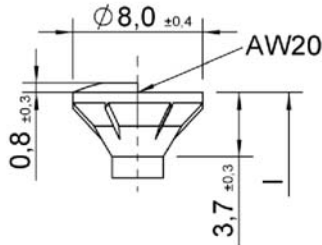

Countersunk head with cutter ribs - design with and without raise

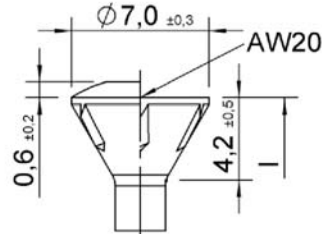

Woodwork head – design with and without raise

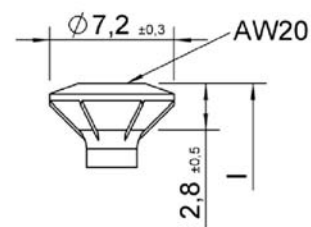

FBS-head

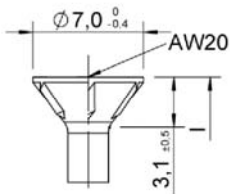

Countersunk head 75° – design with and without raise

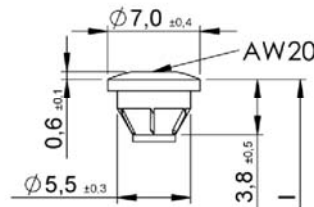

Top head – design with and without raise

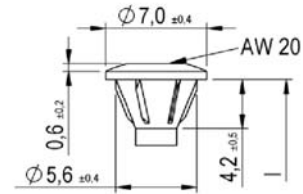

Top head II – design with and without raise

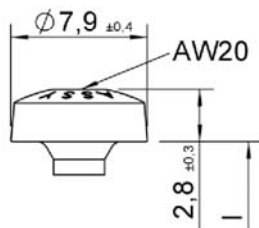

Pan head

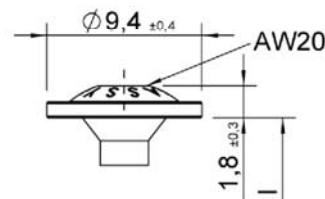

Back panel screw head

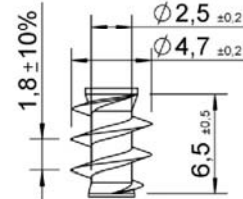

Underhead thread

Würth self-tapping screws

6.3 ASSY screws, stainless steel

Annex 6

### Thread types d = 4.0 mm

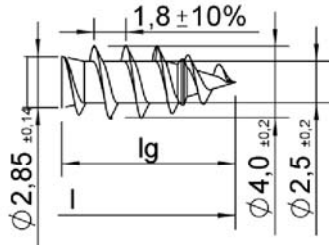

ASSY single - threaded

### Lengths for d = 4.0 mm

l	lg
+1.0	+1.0
- 2.0	- 2.0
18	16
...	...
70	55

Screws without thread in the middle of screw or without thread below head or in combination of both are possible (see page 1 of this Annex). The thread lengths can be manufactured to customer specific within lg min and lg max.

All dimensions in mm.

Würth self-tapping screws

6.3 ASSY screws, stainless steel

Annex 6

### Head types for d = 4.5 mm

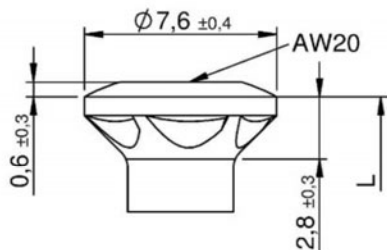

Countersunk head – design:  
with and without raise, with  
and without milling pockets

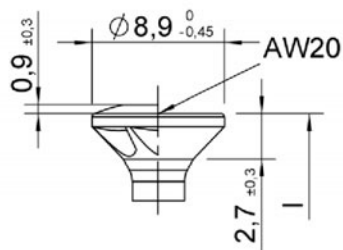

Countersunk head –  
design: with and without  
raise, with and without  
milling pockets

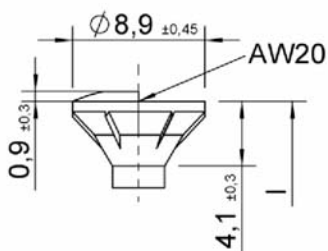

Countersunk head with  
cutter ribs - design with and  
without raise

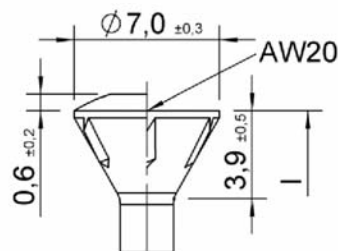

Woodwork head – design  
with and without raise

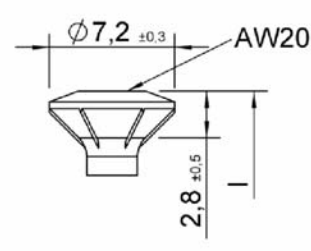

FBS-head

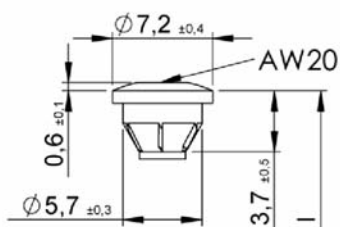

Top head – design with and  
without raise

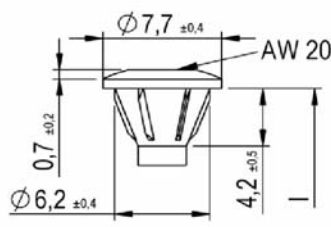

Top head II – design with  
and without raise

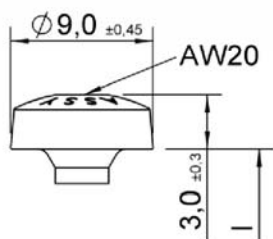

Pan head

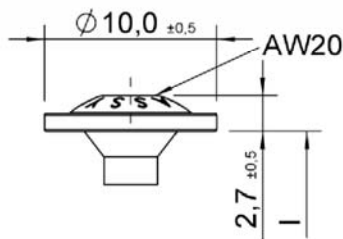

Back panel screw head

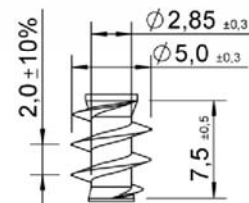

Underhead thread

Würth self-tapping screws

6.3 ASSY screws, stainless steel

Annex 6

### Thread types d = 4.5 mm

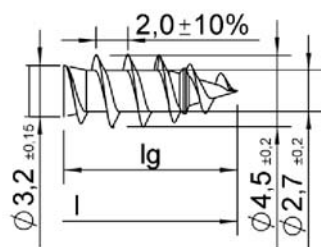

ASSY single - threaded

### Lengths for d = 4.5 mm

l	l <sub>g</sub>
+1.0	+1.0
-2.0	-2.0
20	18
...	...
80	60

Screws without thread in the middle of screw or without thread below head or in combination of both are possible (see page 1 of this Annex). The thread lengths can be manufactured to customer specific within  $l_g$  min and  $l_g$  max.

All dimensions in mm.

Würth self-tapping screws

6.3 ASSY screws, stainless steel

Annex 6



### Head types for d = 5.0 mm

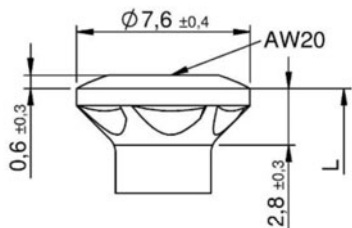

Countersunk head – design: with and without raise, with and without milling pockets

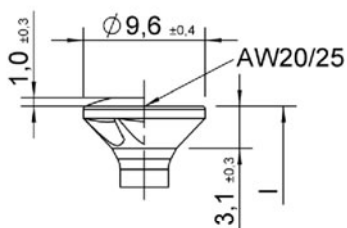

Countersunk head – design: with and without raise, with and without milling pockets

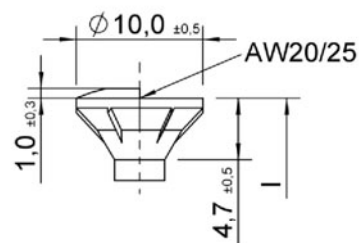

Countersunk head with cutter ribs - design with and without raise

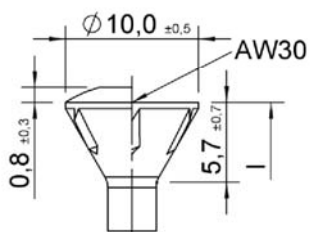

Woodwork head – design with and without raise

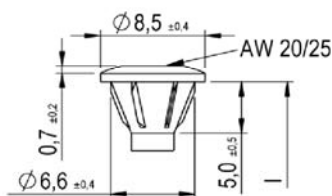

Top head II – design with and without raise

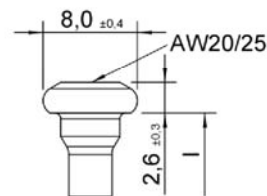

Joist hanger screw head

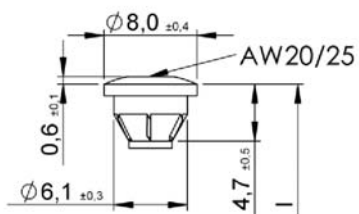

Top head – design with and without raise

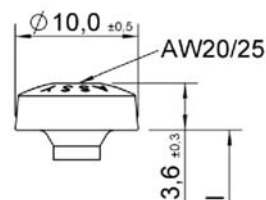

Pan head

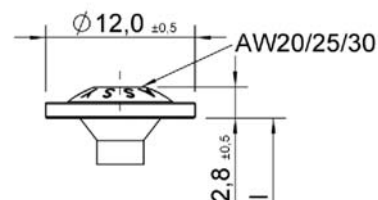

Large washer head

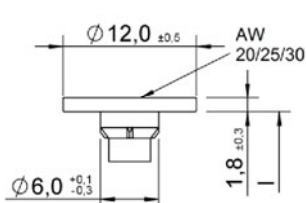

Large washer head II – design with and without raise

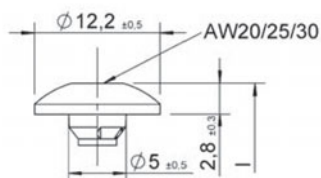

Truss head - design: with and without cutter ribs

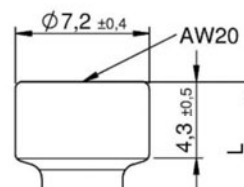

Cylinder head

Würth self-tapping screws

6.3 ASSY screws, stainless steel

Annex 6





Underhead thread

**Thread types d = 5.0 mm**

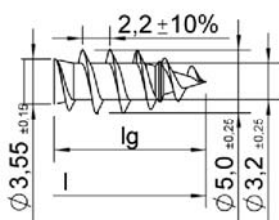

ASSY single - threaded

**Lengths for d = 5.0 mm**

l +1.0 - 2.5	lg +1.0 - 2.0	Shank cutter at ASSY partial thread
22	20	over all lengths optional
...	...	
120	70	

Shank cutter

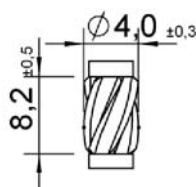

Screws without thread in the middle of screw or without thread below head or in combination of both are possible (see page 1 of this Annex). The thread lengths can be manufactured to customer specific within lg min and lg max.

All dimensions in mm.

Würth self-tapping screws

6.3 ASSY screws, stainless steel

Annex 6

**Head types for d = 6.0 mm**

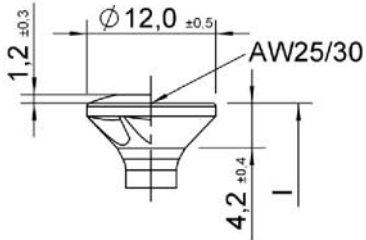

Countersunk head – design: with and without raise, with and without milling pockets

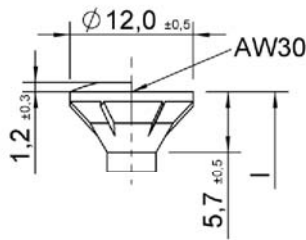

Countersunk head with cutter ribs - design with and without raise

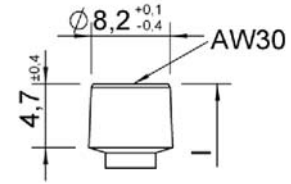

Cylinder head

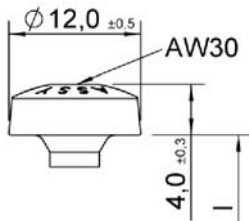

Pan head

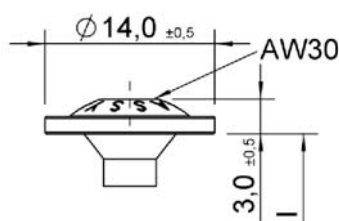

Large washer head

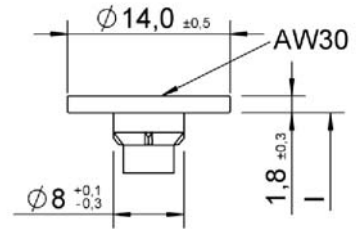

Large washer head II – design with and without raise

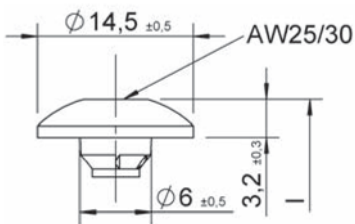

Truss head - design: with and without cutter ribs

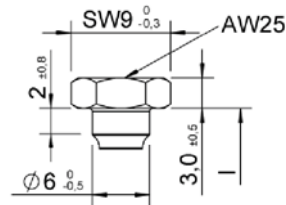

Kombi hexagonal head

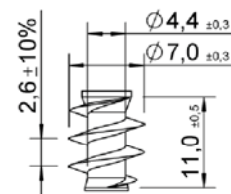

Underhead thread

Electronic copy of the ETA by DIBt: ETA-11/0190

Würth self-tapping screws

6.3 ASSY screws, stainless steel

Annex 6

### Thread types d = 6.0 mm

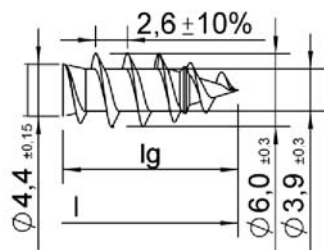

ASSY single - threaded

### Lengths for d = 6.0 mm

l +1.0 - 3.5	lg +1.0 - 2.5	Shank cutter at ASSY partial thread
25	24	over all lengths optional
...	...	
200	120	

Shank  
cutter

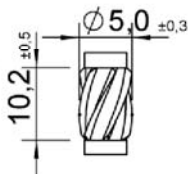

Screws without thread in the middle of screw or without thread below head or in combination of both are possible (see page 1 of this Annex). The thread lengths can be manufactured to customer specific within lg min and lg max.

All dimensions in mm.

Würth self-tapping screws

6.3 ASSY screws, stainless steel

Annex 6

**Head types for d = 8.0 mm**

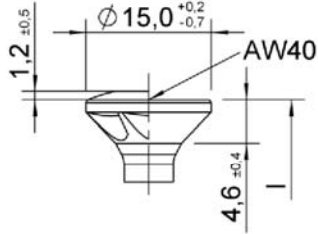

Countersunk head – design: with and without raise, with and without milling pockets

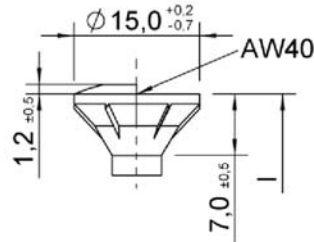

Countersunk head with cutter ribs - design with and without raise

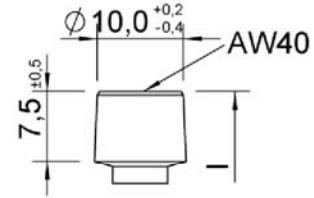

Cylinder head

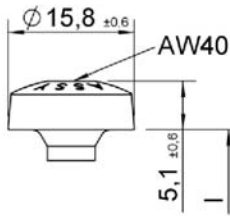

Pan head

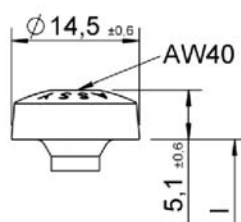

Large washer head

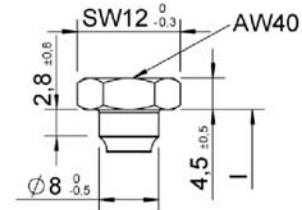

Kombi hexagonal head

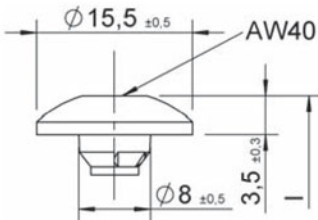

Truss head - design: with and without cutter ribs

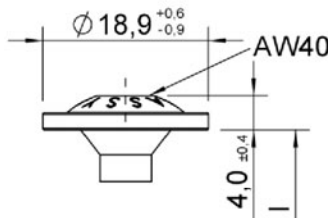

Large washer head

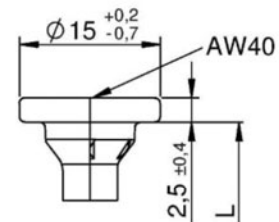

Large washer head II – design with and without raise

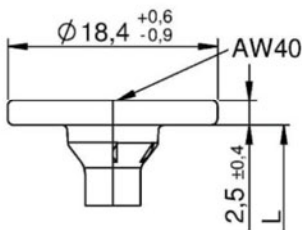

Large washer head II – design with and without raise

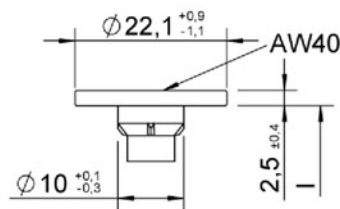

Large washer head II – design with and without raise

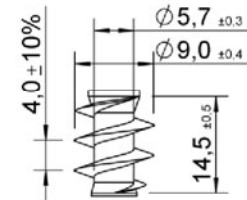

Underhead thread

Würth self-tapping screws

6.3 ASSY screws, stainless steel

Annex 6

### Thread types d = 8.0 mm

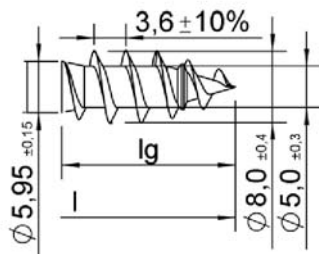

ASSY single - threaded

### Lengths for d = 8.0 mm

l	lg	Shank cutter at ASSY partial thread
+1.0 - 5.0	+1.0 - 2.5	Shank cutter at ASSY partial thread
35	32	up to L = 150: optional
...	...	over l =150: yes
400	160	

Shank  
cutter

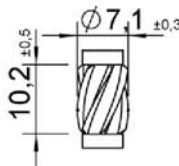

Screws without thread in the middle of screw or without thread below head or in combination of both are possible (see page 1 of this Annex). The thread lengths can be manufactured to customer specific within lg min and lg max.

All dimensions in mm.

Electronic copy of the ETA by DIBt: ETA-11/0190

Würth self-tapping screws

6.3 ASSY screws, stainless steel

Annex 6

Head types for d = 10.0 mm

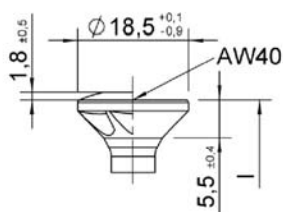

Countersunk head – design: with and without raise, with and without milling pockets

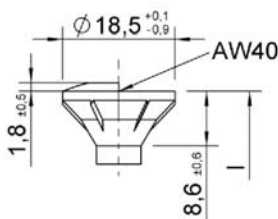

Countersunk head with cutter ribs - design with and without raise

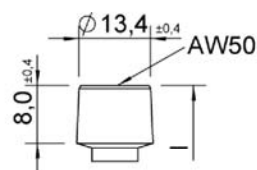

Cylinder head

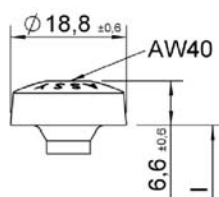

Pan head

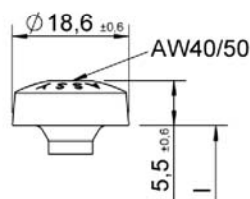

Pan head

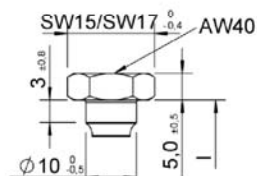

Kombi hexagonal head

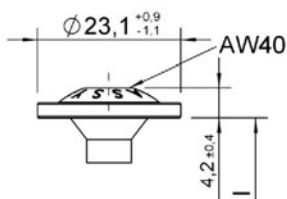

Large washer head

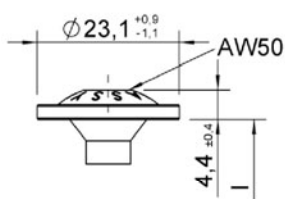

Large washer head

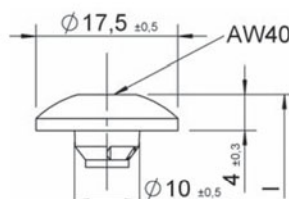

Truss head - design: with and without cutter ribs

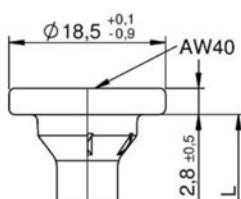

Large washer head II – design with and without raise

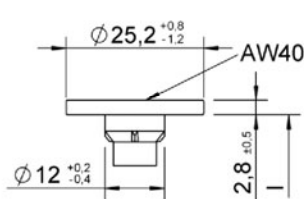

Large washer head II – design with and without raise

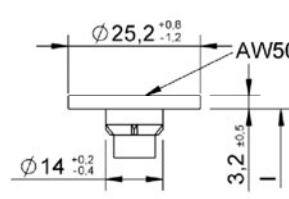

Large washer head II – design with and without raise

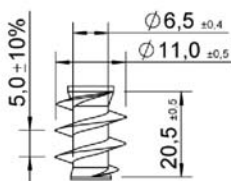

Würth self-tapping screws

6.3 ASSY screws, stainless steel

Annex 6

### Thread types d = 10.0 mm

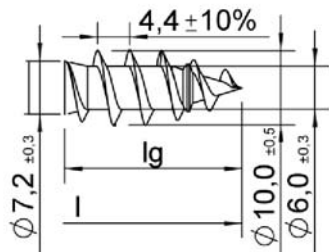

ASSY single - threaded

### Lengths for d = 10.0 mm

l	lg	Shank cutter at ASSY partial thread
+1.0 - 5.0	+1.0 - 2.5	
45	40	up to L = 150: optional
...	...	over L = 150: yes
400	200	

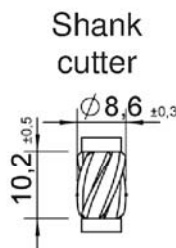

Screws without thread in the middle of screw or without thread below head or in combination of both are possible (see page 1 of this Annex). The thread lengths can be manufactured to customer specific within lg min and lg max.

All dimensions in mm.

Würth self-tapping screws

6.3 ASSY screws, stainless steel

Annex 6



### Head types for d = 3.0 mm

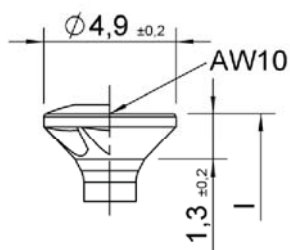

Piano hinge head - design: with and without raise, with and without milling pockets

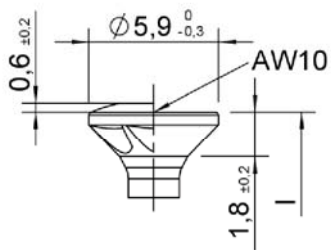

Countersunk head – design: with and without raise, with and without milling pockets

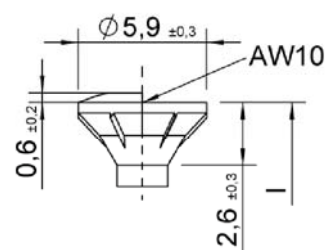

Countersunk head with cutter ribs - design with and without raise

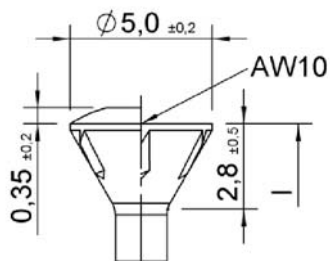

Woodwork head – design with and without raise

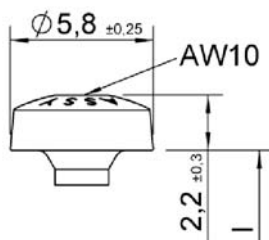

Pan head

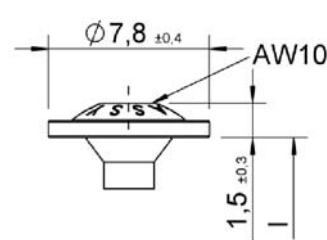

Back panel screw head

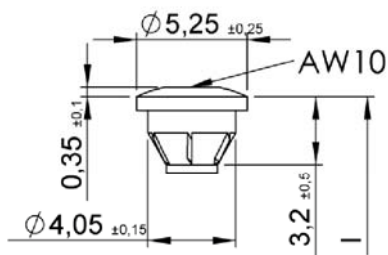

Top head

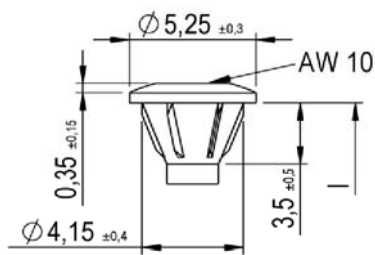

Top head II – design with and without raise

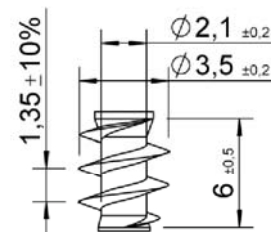

Underhead thread

Würth self-tapping screws

6.4 ASSY plus screws, stainless steel

Annex 6

### Thread types d = 3.0 mm

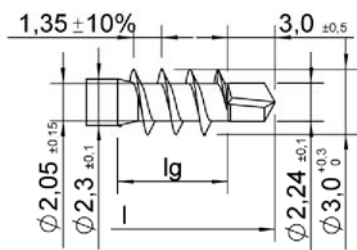

ASSY plus

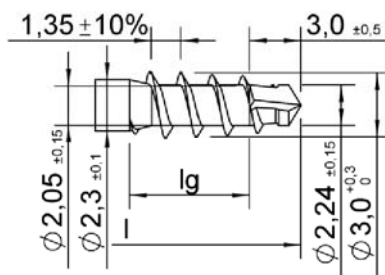

ASSY plus special

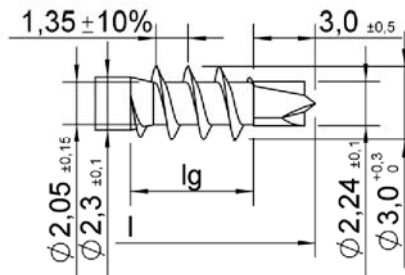

ASSY plus 3.0

### Lengths for d = 3.0 mm

l	lg
+1.0	+1.0
- 2.0	- 2.0
16	12
...	...
50	46

Screws without thread in the middle of screw or without thread below head or in combination of both are possible (see page 1 of this Annex). The thread lengths can be manufactured to customer specific within lg min and lg max.

All dimensions in mm.

Würth self-tapping screws

6.4 ASSY plus screws, stainless steel

Annex 6

**Head types for d = 3.5 mm**

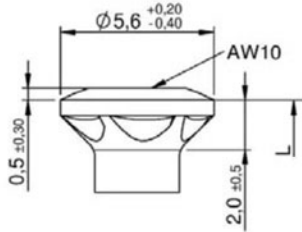

Countersunk head – design: with and without raise, with and without milling pockets

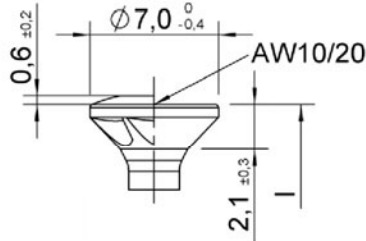

Countersunk head – design: with and without raise, with and without milling pockets

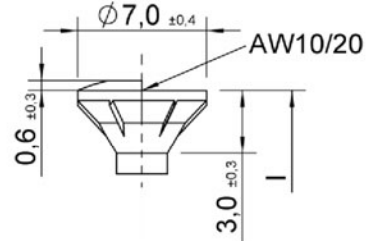

Countersunk head with cutter ribs - design with and without raise

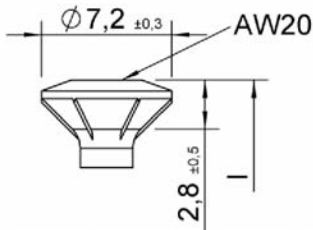

FBS-head

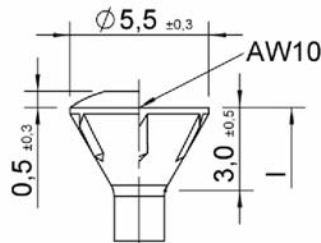

Woodwork head – design with and without raise

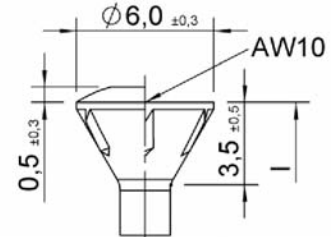

Woodwork head – design with and without raise

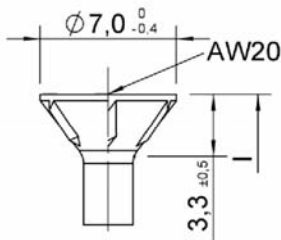

+Countersunk head 75° – design with and without raise

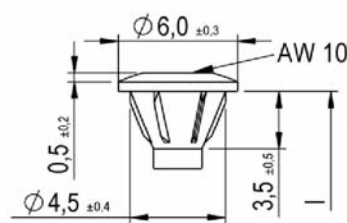

Top head II – design with and without raise

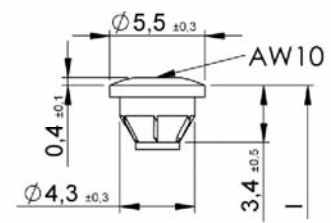

Top head – design with and without raise

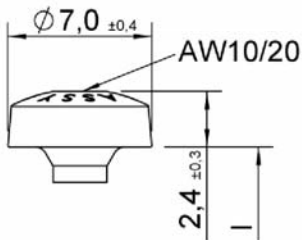

Pan head

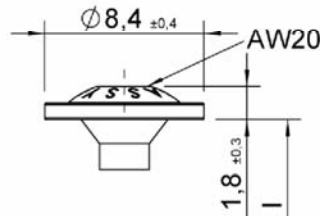

Back panel screw head

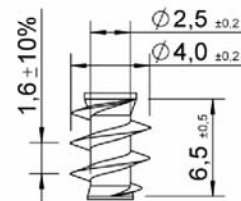

Underhead thread

Würth self-tapping screws

6.4 ASSY plus screws, stainless steel

Annex 6

### Thread types d = 3.5 mm

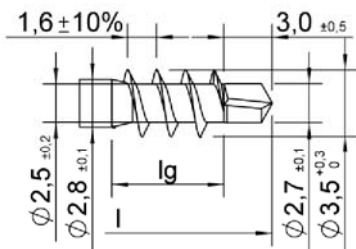

ASSY plus

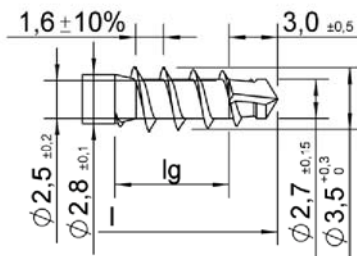

ASSY plus special

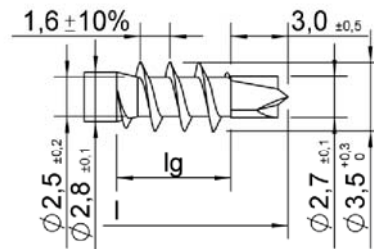

ASSY plus 3.0

### Lengths for d = 3.5 mm

l	lg
+1.0	+1.0
- 2.0	- 2.0
19	14
...	...
50	45

Screws without thread in the middle of screw or without thread below head or in combination of both are possible (see page 1 of this Annex). The thread lengths can be manufactured to customer specific within lg min and lg max.

All dimensions in mm.

Würth self-tapping screws

6.4 ASSY plus screws, stainless steel

Annex 6

### Head types for d = 4.0 mm

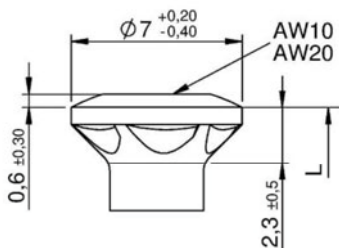

Countersunk head – design: with and without raise, with and without milling pockets

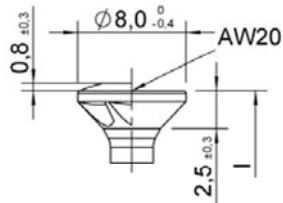

Countersunk head – design: with and without raise, with and without milling pockets

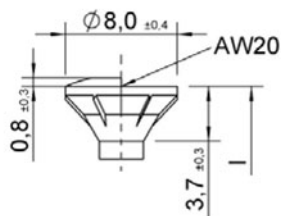

Countersunk head with cutter ribs - design with and without raise

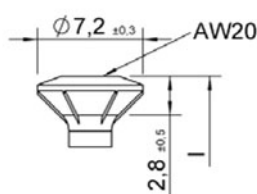

FBS-head

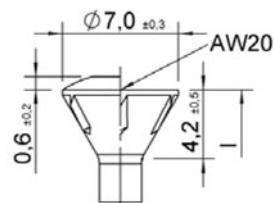

Woodwork head – design with and without raise

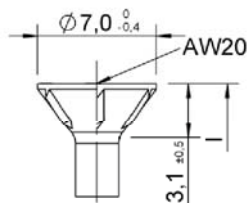

Countersunk head 75° – design with and without raise

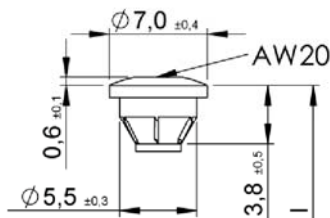

Top head – design with and without raise

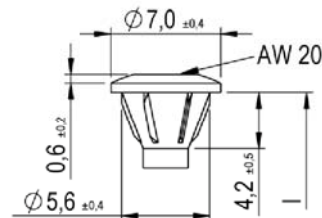

Top head II – design with and without raise

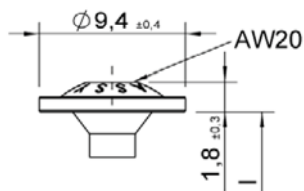

Back panel screw head

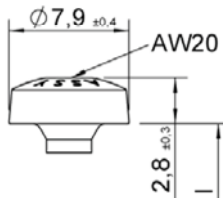

Pan head

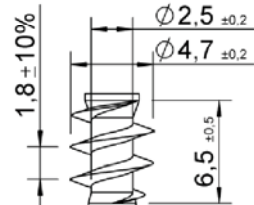

Underhead thread

Würth self-tapping screws

6.4 ASSY plus screws, stainless steel

Annex 6

### Thread types d = 4.0 mm

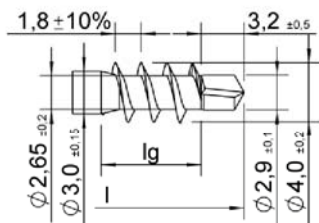

ASSY plus

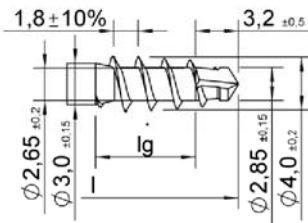

ASSY plus special

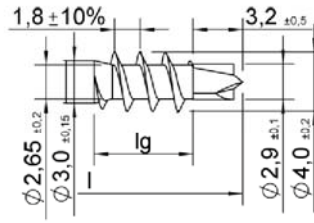

ASSY plus 3.0

### Lengths for d = 4.0 mm

l	lg
+1.0	+1.0
- 2.0	- 2.0
23	16
...	...
70	64

Screws without thread in the middle of screw or without thread below head or in combination of both are possible (see page 1 of this Annex). The thread lengths can be manufactured to customer specific within lg min and lg max.

All dimensions in mm.

Würth self-tapping screws

6.4 ASSY plus screws, stainless steel

Annex 6



### Head types for d = 4.5 mm

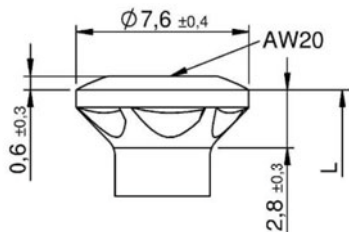

Countersunk head – design: with and without raise, with and without milling pockets

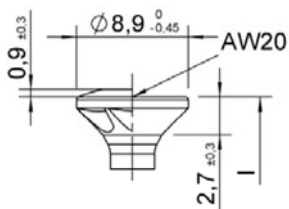

Countersunk head – design: with and without raise, with and without milling pockets

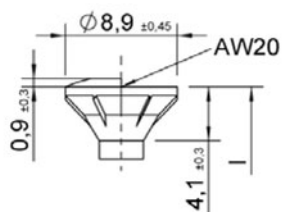

Countersunk head with cutter ribs - design with and without raise

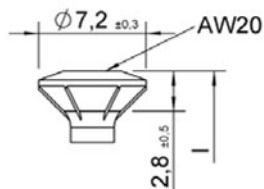

FBS-head

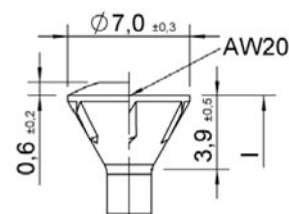

Woodwork head – design with and without raise

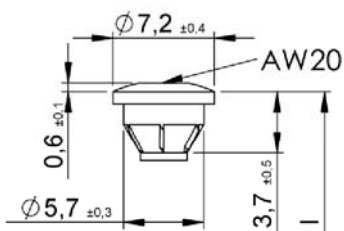

Top head – design with and without raise

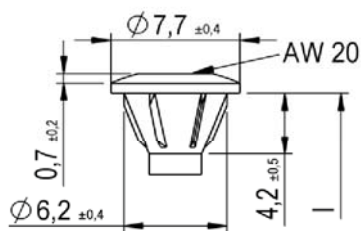

Top head II – design with and without raise

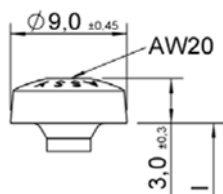

Pan head

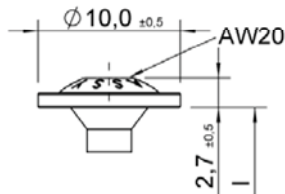

Back panel screw head

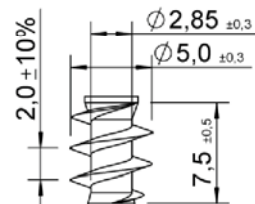

Underhead thread

Würth self-tapping screws

6.4 ASSY plus screws, stainless steel

Annex 6



### Thread types d = 4.5 mm

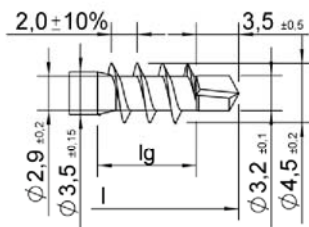

ASSY plus

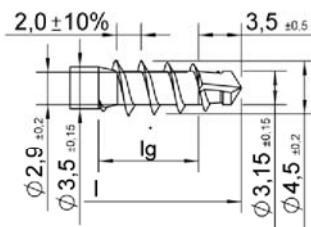

ASSY plus special

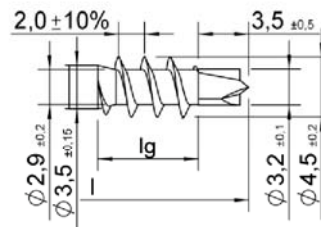

ASSY plus 3.0

### Lengths for d = 4.5 mm

l	lg
+1.0	+1.0
-2.0	-2.0
23	18
...	...
80	78

Screws without thread in the middle of screw or without thread below head or in combination of both are possible (see page 1 of this Annex). The thread lengths can be manufactured to customer specific within lg min and lg max.

All dimensions in mm.

Würth self-tapping screws

6.4 ASSY plus screws, stainless steel

Annex 6

English translation prepared by DIBt

**Head types for d = 5.5 mm**

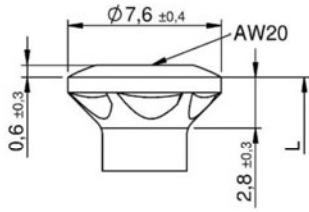

Countersunk head – design: with and without raise, with and without milling pockets

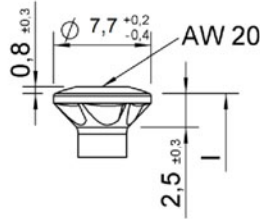

Terrassenbaukopf – Ausführungen mit und ohne Linse, mit und ohne Frästaschen

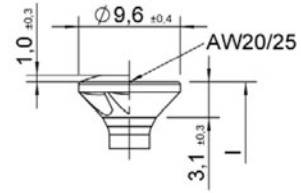

Countersunk head – design: with and without raise, with and without milling pockets

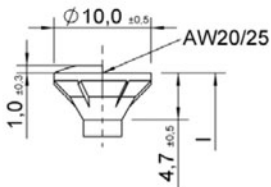

Countersunk head with cutter ribs - design with and without raise

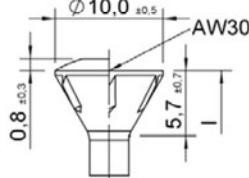

Woodwork head – design with and without raise

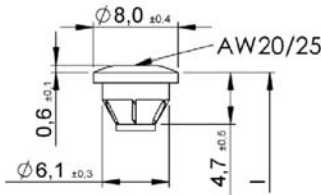

Top head – design with and without raise

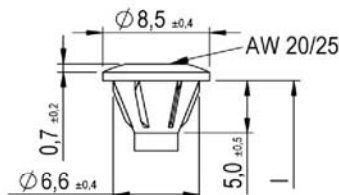

Top head II – design with and without raise

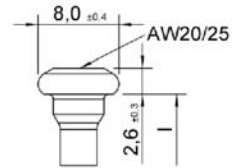

Joist hanger screw head

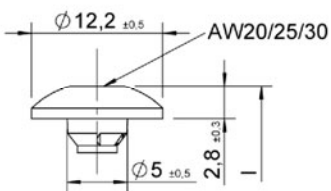

Truss head - design: with and without cutter ribs

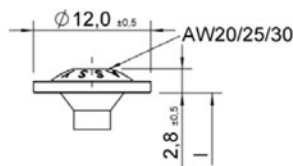

Large washer head

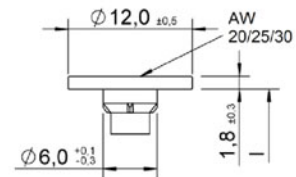

Large washer head II – design with and without raise

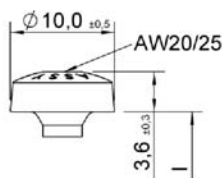

Pan head

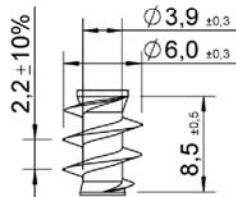

Underhead thread

Würth self-tapping screws

6.4 ASSY plus screws, stainless steel

Annex 6

**Thread types d = 5.5 mm**

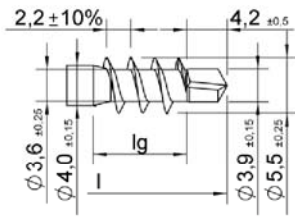

ASSY plus

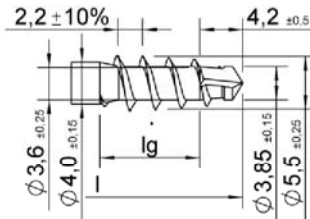

ASSY plus special

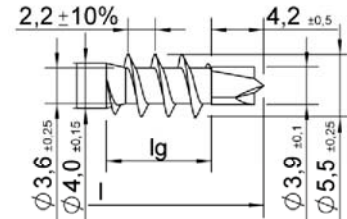

ASSY plus 3.0

**Lengths for d = 5.5 mm**

l +1.0 - 2.5	lg +1.0 - 2.0	Shank cutter at ASSY plus / 3.0 / special partial thread
25	20	over all lengths optional
...	...	
120	90	

Shank  
cutter

Optional: Thread of curves all over the  
shank at partial thread

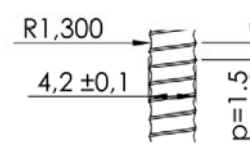
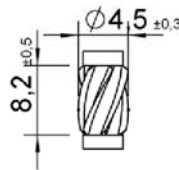

Screws without thread in the middle of screw or without thread below head or in combination of both are possible (see page 1 of this Annex). The thread lengths can be manufactured to customer specific within lg min and lg max.

All dimensions in mm.

### Head types for d = 6.5 mm

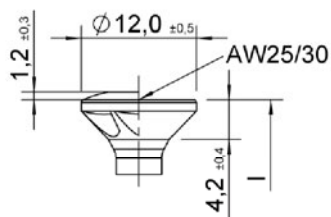

Countersunk head –  
design: with and without  
raise, with and without  
milling pockets

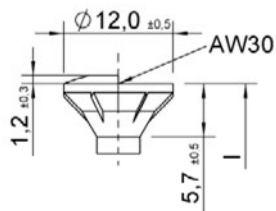

Countersunk head with  
cutter ribs - design with  
and without raise

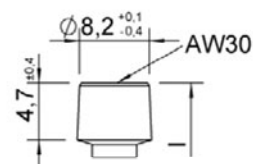

Cylinder head

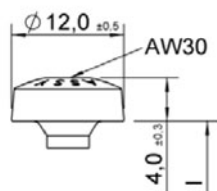

Pan head

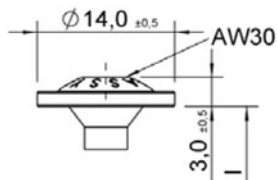

Large washer head

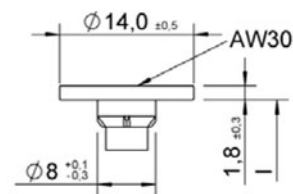

Large washer head II –  
design with and without  
raise

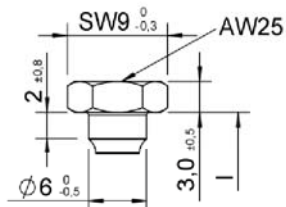

Kombi hexagonal head

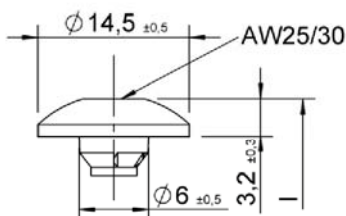

Truss head - design: with  
and without cutter ribs

Würth self-tapping screws

6.4 ASSY plus screws, stainless steel

Annex 6

### Thread types d = 6.5 mm

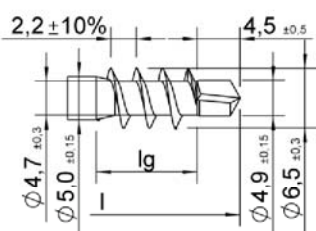

ASSY plus

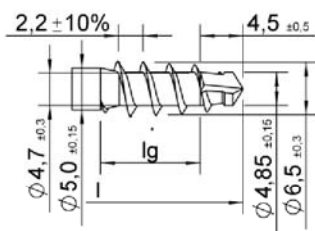

ASSY plus special

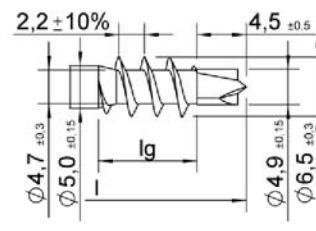

ASSY plus 3.0

### Lengths for d = 6.5 mm

l	lg	Shank cutter at ASSY plus / 3.0 / special partial thread
+1.0 - 3.5	+1.0 - 2.5	
30	24	over all lengths optional
...	...	
300	140	

Shank  
cutter

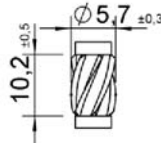

Screws without thread in the middle of screw or without thread below head or in combination of both are possible (see page 1 of this Annex). The thread lengths can be manufactured to customer specific within lg min and lg max.

All dimensions in mm.

Würth self-tapping screws

6.4 ASSY plus screws, stainless steel

Annex 6

### Head types for d = 8.0 mm

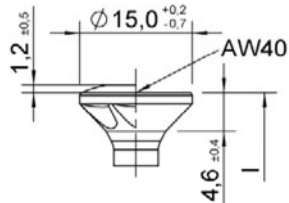

Countersunk head –  
design: with and without  
raise, with and without  
milling pockets

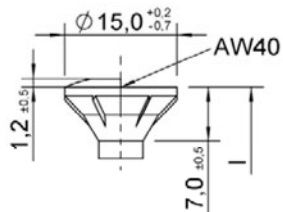

Countersunk head with  
cutter ribs - design with  
and without raise

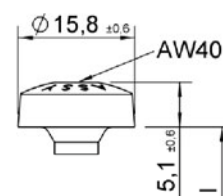

Pan head

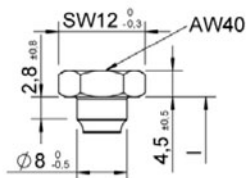

Kombi hexagonal head

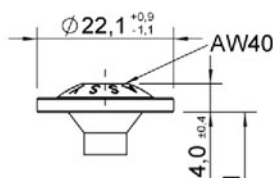

Large washer head

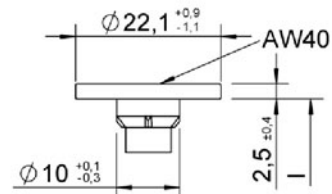

Large washer head II –  
design with and without  
raise

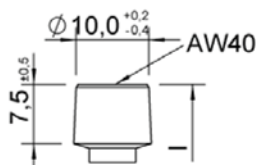

Cylinder head

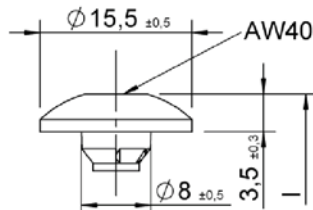

Truss head - design: with  
and without cutter ribs

Würth self-tapping screws

6.4 ASSY plus screws, stainless steel

Annex 6

### Thread types d = 8.0 mm

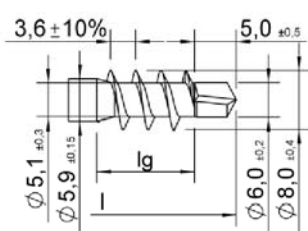

ASSY plus

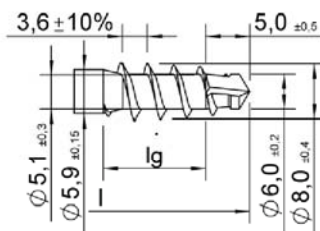

ASSY plus special

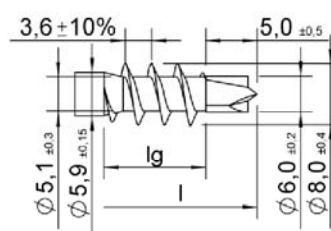

ASSY plus 3.0

### Lengths for d = 8.0 mm

l	lg	Shank cutter at ASSY plus / 3.0 / special partial thread
+1.0 - 5.0	+1.0 - 2.5	
40	32	over all lengths optional
...	...	
440	240	

Shank cutter

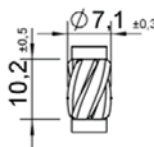

Screws without thread in the middle of screw or without thread below head or in combination of both are possible (see page 1 of this Annex). The thread lengths can be manufactured to customer specific within lg min and lg max.

All dimensions in mm.

Würth self-tapping screws

6.4 ASSY plus screws, stainless steel

Annex 6



### Head types for d = 6.0 mm

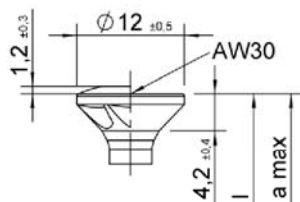

Countersunk head – design: with and without raise, with and without milling pockets

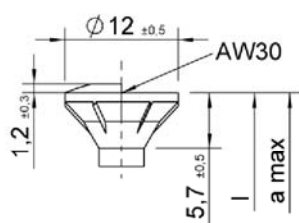

Countersunk head with cutter ribs - design with and without raise

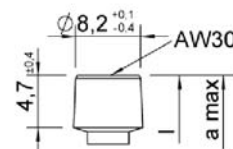

Cylinder head

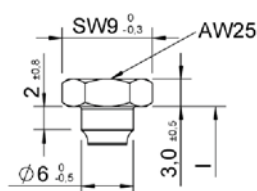

Kombi hexagonal head

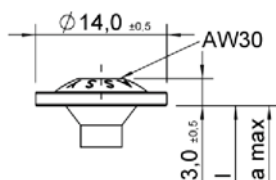

Large washer head

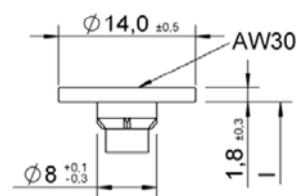

Large washer head II – design with and without raise

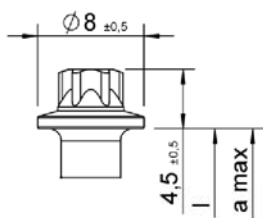

Hexalobular head

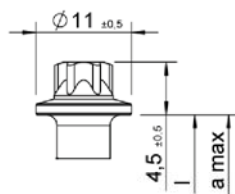

Hexalobular head

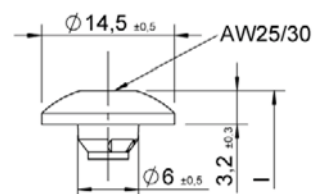

Truss head - design: with and without cutter ribs

Würth self-tapping screws

6.5 ASSY plus VG screws, carbon steel

Annex 6

### Thread types d = 6.0 mm

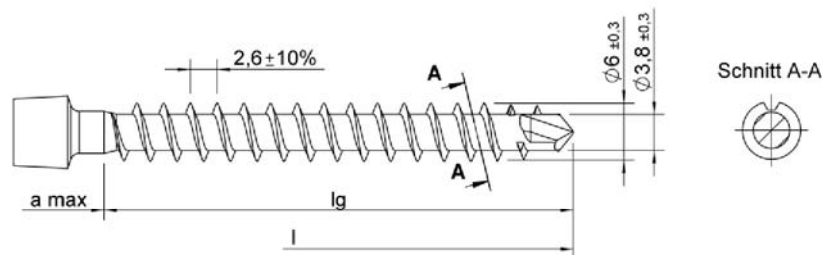

Design with and without cutting edges (see section (Schnitt) A-A)

### Lengths for d = 6.0 mm

Countersunk- and Cylinder head

l	lg	a max
+1.0	+2.0	
-3.0	-6.0	
70	63	10.0
...	...	
120	113	10.0

Large washer-, Hexagonal and Hexalobular head

l	lg	a max
+1.0	+6.0	
-3.0	-2.0	
70	63	6.0
...	...	
120	113	6.0

l	lg	a max
+1.0	+2.0	
-5.0	-10.0	
130	123	12.0
...	...	
260	253	12.0

l	lg	a max
+1.0	+6.0	
-5.0	-6.0	
130	123	8.0
...	...	...
260	253	8.0

For non-standard use (optional, see page 1 of this Annex): Part without thread in the middle of screw / Part without thread below head / Combination of both. All dimensions in mm. Lg can be reduced down to min 4xd.

Würth self-tapping screws

6.5 ASSY plus VG screws, carbon steel

Annex 6

**Head types for d = 8.0 mm**

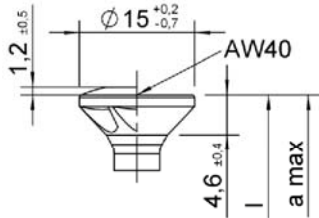

Countersunk head – design: with and without raise, with and without milling pockets

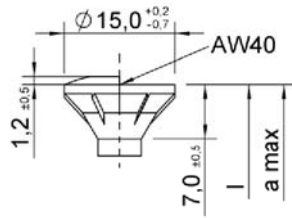

Countersunk head with cutter ribs - design with and without raise

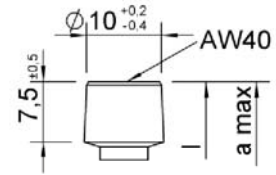

Cylinder head

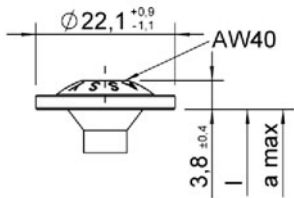

Large washer head

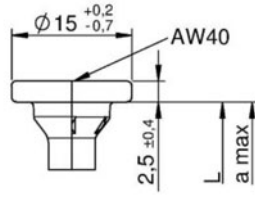

Large washer head II – design with and without raise

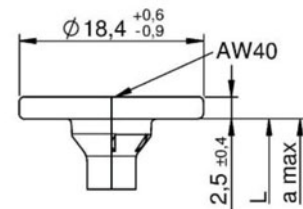

Large washer head II – design with and without raise

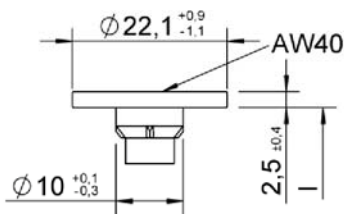

Large washer head II – design with and without raise

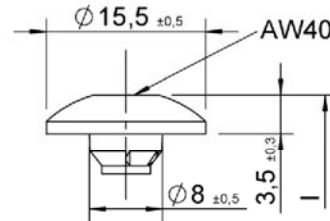

Truss head - design: with and without cutter ribs

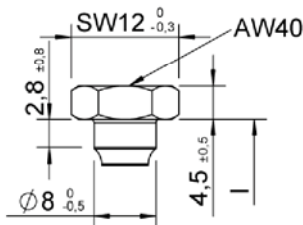

Kombi hexagonal head

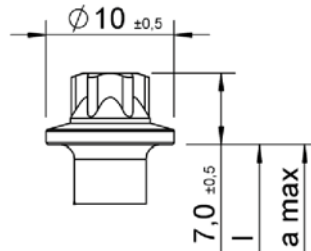

Hexalobular head

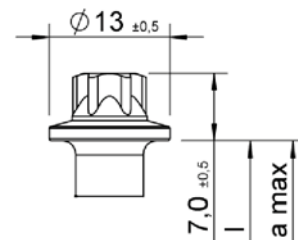

Hexalobular head

Würth self-tapping screws

6.5 ASSY plus VG screws, carbon steel

Annex 6

### Thread types d = 8.0 mm

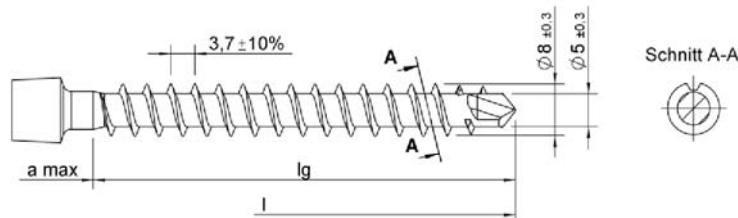

Design with and without cutting edges (see section (Schnitt) A-A)

### Lengths for d = 8.0 mm

#### Countersunk- and Cylinder head

l	lg	a max
+1.0	+4.0	
- 5.0	- 8.0	
80	69	14.0
...	...	
280	269	14.0

#### Large washer-, Hexagonal and Hexalobular head

l	lg	a max
+1.0	+10.0	
- 5.0	- 2.0	
80	69	8.0
...	...	
280	269	8.0

l	lg	a max
+1.0	+4.0	
- 10.0	- 14.0	
290	279	15.0
...	...	
450	439	15.0

l	lg	a max
+1.0	+10.0	
- 10.0	- 8.0	
290	279	9.0
...	...	...
450	439	8.0

l	lg	a max
+5.0	+11.0	
- 15.0	- 21.0	
460	446	20.0
...	...	
600	586	20.0

l	lg	a max
+5.0	+17.0	
- 15.0	- 15.0	
460	446	14.0
...	...	...
600	586	14.0

For non-standard use (optional, see page 1 of this Annex): Part without thread in the middle of screw / Part without thread below head / Combination of both. All dimensions in mm. Lg can be reduced down to min 4xd.

Würth self-tapping screws

6.5 ASSY plus VG screws, carbon steel

Annex 6

### Head types for d = 10.0 mm

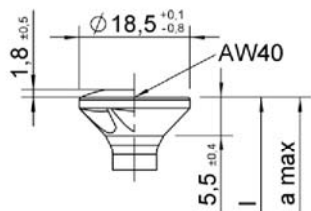

Countersunk head – design: with and without raise, with and without milling pockets

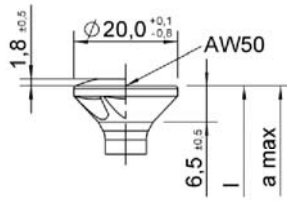

Countersunk head – design: with and without raise, with and without milling pockets

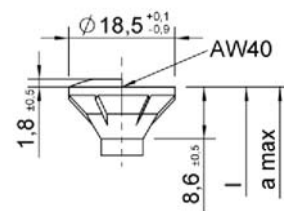

Countersunk head with cutter ribs - design with and without raise

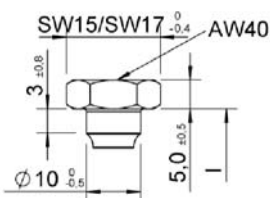

Kombi hexagonal head

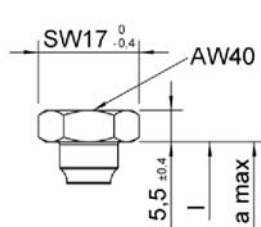

Kombi hexagonal head

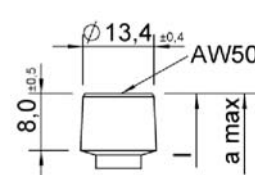

Cylinder head

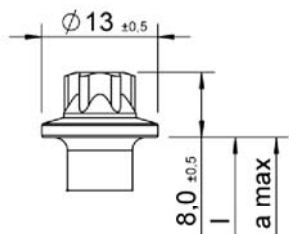

Hexalobular head

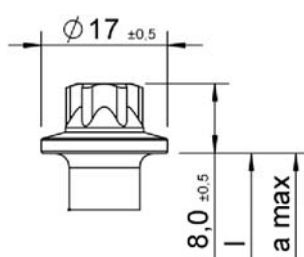

Hexalobular head

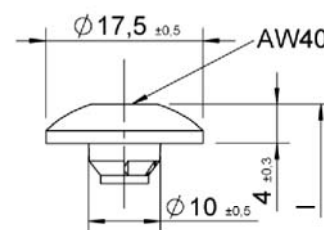

Truss head - design: with and without cutter ribs

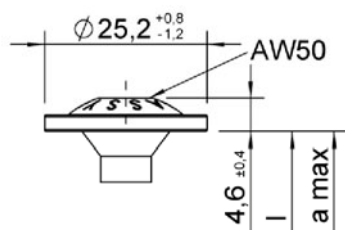

Large washer head

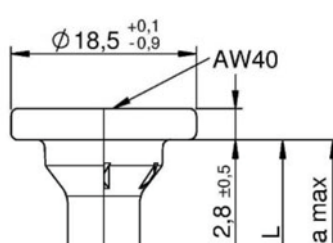

Large washer head II – design with and without raise

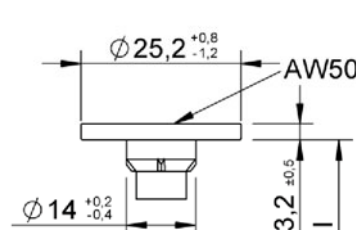

Large washer head II – design with and without raise

Würth self-tapping screws

6.5 ASSY plus VG screws, carbon steel

Annex 6

**Thread types d = 10.0 mm**

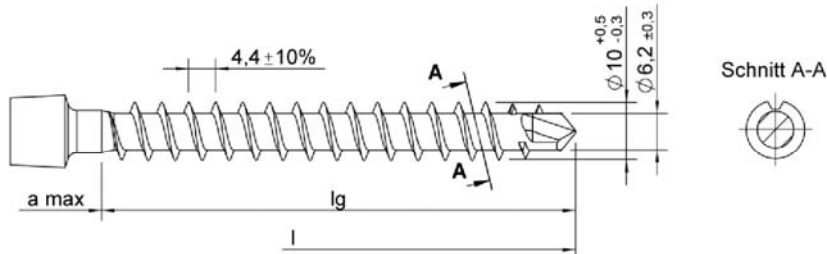

Design with and without cutting edges (see section (Schnitt) A-A)

**Lengths for d = 10.0 mm**

Countersunk- and Cylinder head

l	lg	a max
+1.0 - 5.0	+5.0 - 11.0	
100	88	18.0
...	...	
280	268	18.0

Large washer-, Hexagonal and Hexalobular head

l	lg	a max
+1.0 - 5.0	+8.0 - 8.0	
100	88	15.0
...	...	...
280	268	15.0

l	lg	a max
+1.0 - 10.0	+5.0 - 16.0	
290	278	18.0
...	...	
450	438	18.0

l	lg	a max
+1.0 - 10.0	+8.0 - 13.0	
290	278	15.0
...	...	...
450	438	15.0

l	lg	a max
+5.0 - 15.0	+12.0 - 23.0	
460	445	23.0
...	...	
800	785	23.0

l	lg	a max
+5.0 - 15.0	+15.0 - 20.0	
460	445	20.0
...	...	...
800	785	20.0

For non-standard use (optional, see page 1 of this Annex): Part without thread in the middle of screw / Part without thread below head / Combination of both. All dimensions in mm.  $l_g$  can be reduced down to  $\min 4 \times d$ .

Würth self-tapping screws

6.5 ASSY plus VG screws, carbon steel

Annex 6



**Head types for d = 12.0 mm**

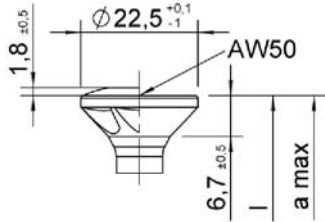

Countersunk head – design: with and without raise, with and without milling pockets

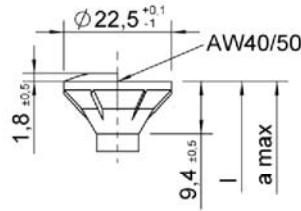

Countersunk head with cutter ribs - design with and without raise

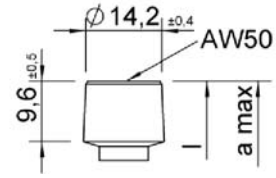

Cylinder head

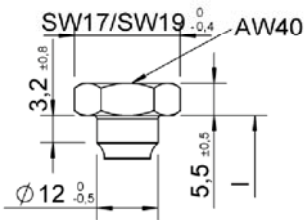

Kombi hexagonal head

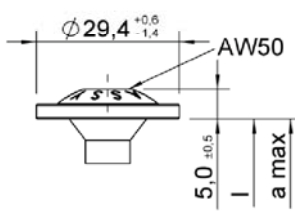

Large washer head

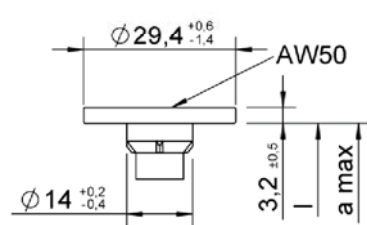

Large washer head II – design with and without raise

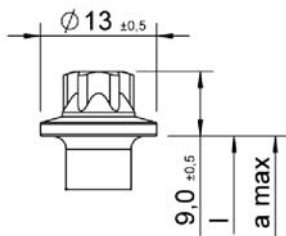

Hexalobular head

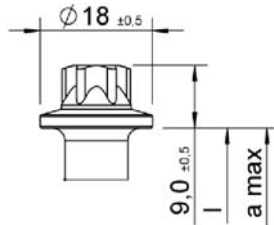

Hexalobular head

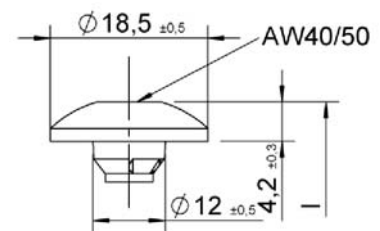

Truss head - design: with and without cutter ribs

Würth self-tapping screws

6.5 ASSY plus VG screws, carbon steel

Annex 6



### Thread types d = 12.0 mm

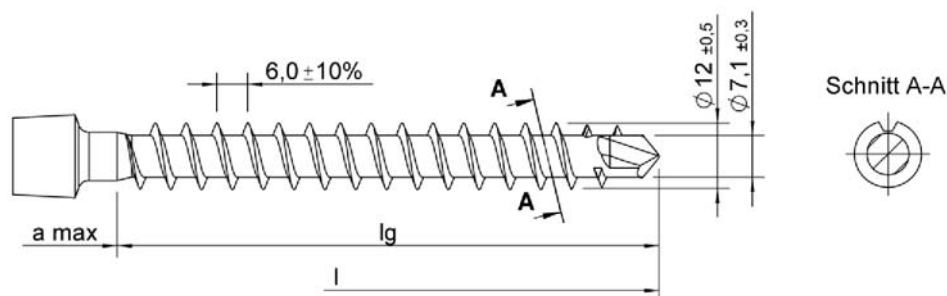

Design with and without cutting edges (see section (Schnitt) A-A)

### Lengths for d = 12.0 mm

Countersunk- and Cylinder head

l	lg	a max
+ 1.0	+ 6.0	
- 5.0	- 11.0	
120	105	21.0
...	...	
240	225	21.0

Large washer-, Hexagonal and Hexalobular head

l	lg	a max
+1.0	+10.0	
- 5.0	- 7.0	
120	105	17.0
...	...	...
240	225	17.0

l	lg	a max
+ 5.0	+ 12.0	
- 15.0	- 24.0	
250	233	26.0
...	...	
600	583	26.0

l	lg	a max
+5.0	+16.0	
- 15.0	- 20.0	
250	233	22.0
...	...	...
600	583	22.0

For non-standard use (optional, see page 1 of this Annex): Part without thread in the middle of screw / Part without thread below head / Combination of both. All dimensions in mm. Lg can be reduced down to min 4xd.

Würth self-tapping screws

6.5 ASSY plus VG screws, carbon steel

Annex 6

**Head types for d = 14.0 mm**

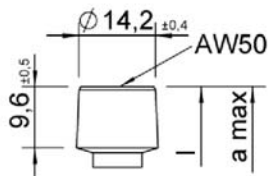

Cylinder head

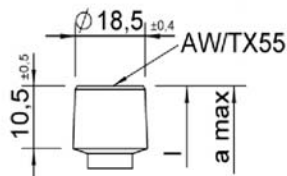

Cylinder head

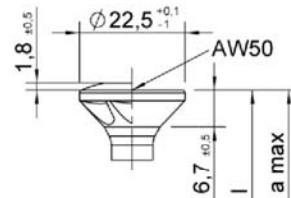

Countersunk head – design: with and without raise, with and without milling pockets

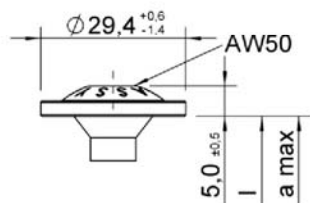

Large washer head

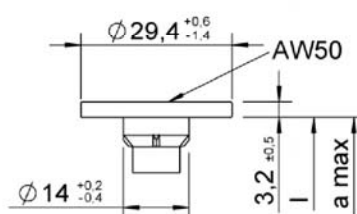

Large washer head II – design with and without raise

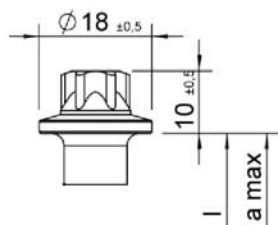

Hexalobular head

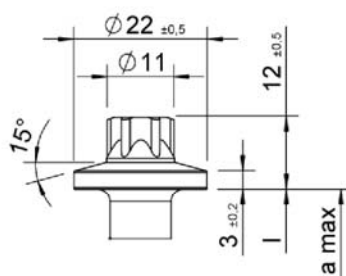

Hexalobular head

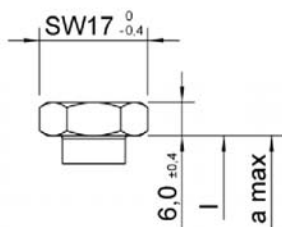

Kombi hexagonal head

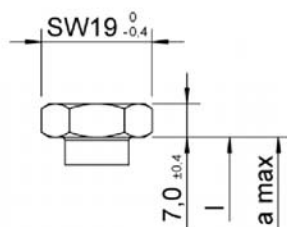

Kombi hexagonal head

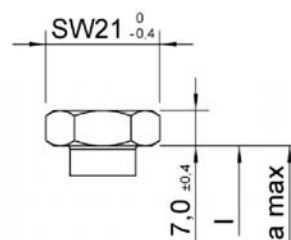

Kombi hexagonal head

Würth self-tapping screws

6.5 ASSY plus VG screws, carbon steel

Annex 6

### Thread types d = 14.0 mm

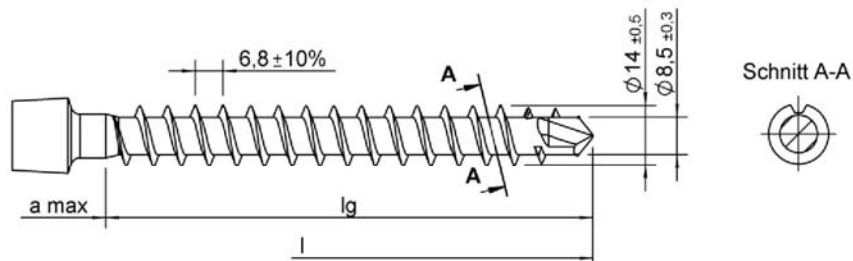

Design with and without cutting edges (see section (Schnitt) A-A)

### Lengths for d = 14.0 mm

#### Countersunk- and Cylinder head

l	lg	a max
+1.0	+5.0	
- 5.0	- 12.0	
120	105	22.0
...	...	
200	185	22.0

#### Large washer-, Hexagonal and Hexalobular head

l	lg	a max
+1.0	+10.0	
- 5.0	- 7.0	
120	105	17.0
...	...	...
200	185	17.0

l	lg	a max
+5.0	+9.0	
- 15.0	- 27.0	
210	195	27.0
...	...	
800	785	27.0

l	lg	a max
+5.0	+14.0	
- 15.0	- 22.0	
210	195	22.0
...	...	...
800	785	22.0

l	lg	a max
+10.0	+14.0	
- 20.0	- 32.0	
810	795	27.0
...	...	
2000	1985	27.0

l	lg	a max
+10.0	+19.0	
- 20.0	- 27.0	
810	795	22.0
...	...	...
2000	1985	22.0

For non-standard use (optional, see page 1 of this Annex): Part without thread in the middle of screw / Part without thread below head / Combination of both. All dimensions in mm. Lg can be reduced down to min 4xd.

Würth self-tapping screws

6.5 ASSY plus VG screws, carbon steel

Annex 6

### Head types

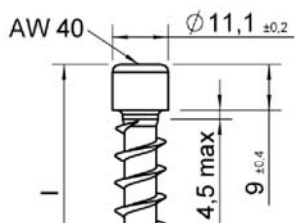

Cylinder head

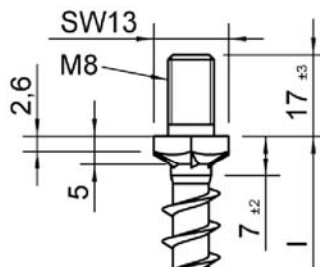

Hexagon countersunk head with connection thread

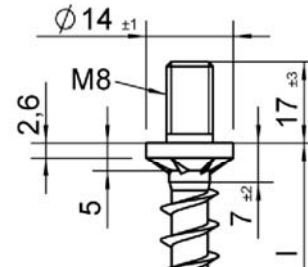

Round countersunk head with connection thread

### Thread types

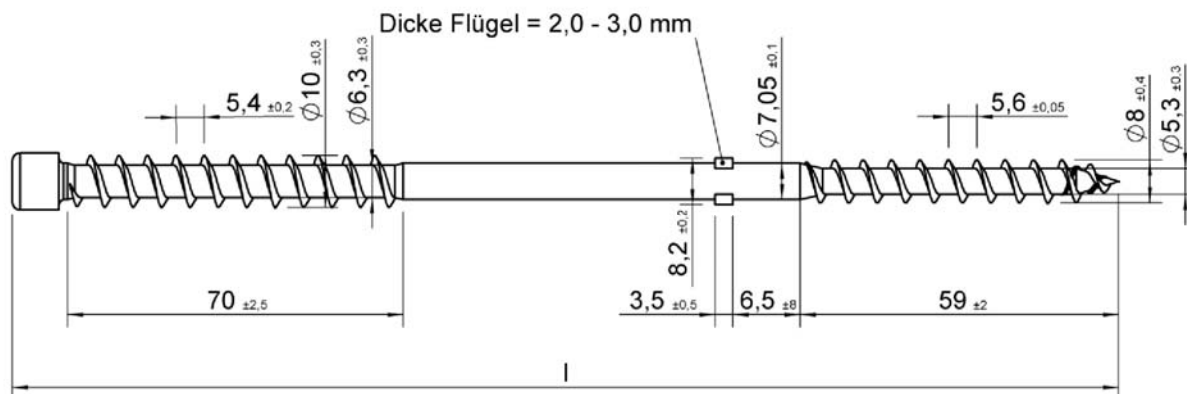

ASSY coarse thread – Design with and without mating thread in thread  $d=8$ ; with and without wings (Flügel).

### Lengths

I
+1.0
- 3.0
210
...
560

All dimensions in mm.

Würth self-tapping screws

6.6 ASSY Isotop screws, carbon steel

Annex 6

Lieferantenkennzeichen

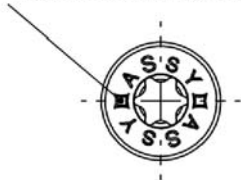

Marking at ASSY d = 3-6 of designs:  
Countersunk heads, Kombi, Pan head  
and Large washer head.  
Named head types are possible without  
marking, too.

Lieferantenkennzeichen

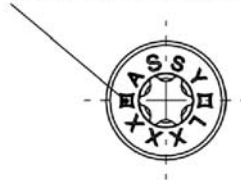

Marking at ASSY d = 7-14 of designs:  
Countersunk heads, Truss head, Kombi,  
Pan head and Large washer head.  
Named head types are possible without  
marking, too.

### Countersunk washers pressed, material steel, aluminium and stainless steel

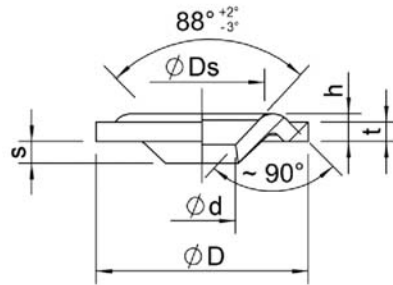

#### Dimensions

	$t \pm 0.4$	$D \pm 0.5$	$d + 0.5$	$h + 0.5$	$D_s \pm 1$	$s \pm 0.75$
6	2.5	22	6.5	3.0	13.0	2.4
8	3.0	28	8.5	3.5	16.0	3.3
10	3.0	33	10.5	4.3	19.5	3.4
12	4.0	42	12.5	5.0	23.0	3.0

All dimensions in mm.

### Countersunk washers turned, material steel, aluminum and stainless steel

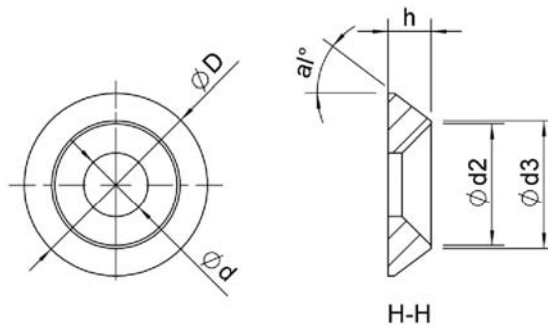

#### Dimensions steel and aluminium

	$d \pm 0.2$	$D \pm 0.5$	$h \pm 0.3$	$\alpha$ (°)	$d_2 \pm 0.3$	$d_3 \pm 0.3$
6	6.4	22	4.5	45	14.0	15.0
8	8.4	25.0	5.0	41	17.0	18.0
10	10.4	30.0	7.0	37	20.0	21.0

All dimensions in mm.

#### Dimensions stainless steel

	$d_1 \pm 0.2$	$D \pm 0.5$	$h \pm 0.3$	$\alpha$ (°)	$d_2 \pm 0.3$	$d_3 \pm 0.3$
6	6.4	22	3.8	45	14.0	14.5
8	8.4	25.0	5.0	45	18.4	19.0
10	10.4	30.0	7.0	37	20.0	21.0

All dimensions in mm.

Würth self-tapping screws

6.8 Würth ASSY washers

Annex 6



**Countersunk washers 45°, material steel cast and stainless steel cast**

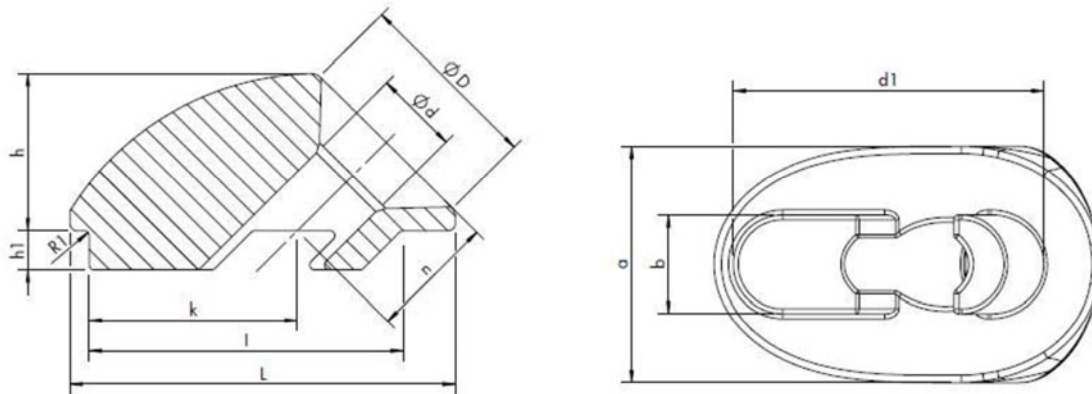

Dimensions; All dimensions in mm.

	d	D	L	a	h0	h1	b	L	K	n
	±0.3	±0.5	±1	±0.5	±0.8	±0.4	±0.2	±0.3	±0.3	±0.5
6	6.5	14.5	28.5	17.0	13,5	2,7	6.9	21.7	13.5	10.9
8	8.5	19.0	39.0	24.0	16,0	3,7	9.9	31.7	21.0	12.7
10	10.7	24.0	52.0	29.0	21,4	4,7	10.8	43.7	28.7	18.4
12	12.7	26.0	59.0	30.0	23,5	5,6	12.8	49.7	34.0	19.8

**Countersunk washers 45°, material steel and stainless steel, turned**

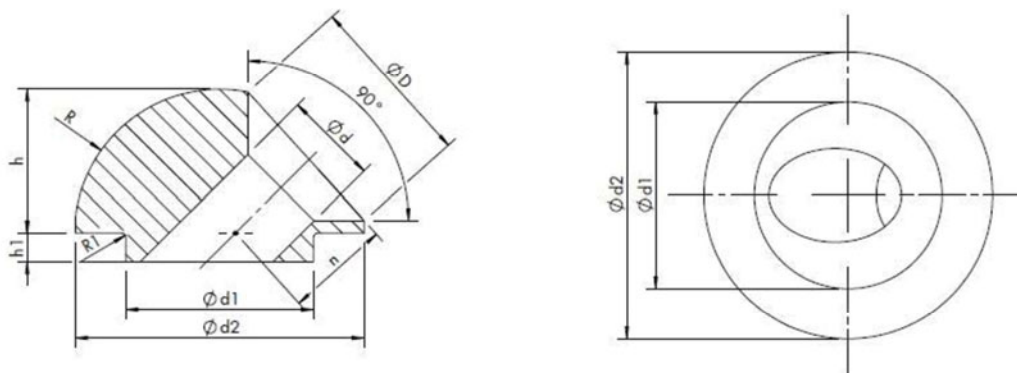

Maße; All dimensions in mm.

	d ±0.3	D ±0.5	d1 ±0.2	d2 ±0.5	h ±0.8	h1 ±0.3	n ±0.5	R-Kugel ±0.5
6	6.5	12	12.9	20.0	10.0	1.9	7.2	10
8	8.5	15	15.9	25.0	11.6	1.9	9.1	12.5

Washers: Galvanized steel and stainless steel material according to DIN 436, DIN 440, DIN 1052, EN 7093 and EN 9021 with the following possible surface coatings: blank, brass-plated, nickel-plated, browned, black chromated, black zinc chromated, yellow chromated, blue passivated, zinc-nickel coating, zinc plate, rusper, holly or partially painted, hot galvanized, aluminum coating

Würth self-tapping screws

6.8 Würth ASSY washers

Annex 6