



ETA-Danmark A/S  
Göteborg Plads 1  
DK-2150 Nordhavn  
Tel. +45 72 24 59 00  
Internet [www.etadanmark.dk](http://www.etadanmark.dk)

Authorised and notified  
according to Article 29 of the  
Regulation (EU)  
No 305/2011 of the European  
Parliament and of the Council  
of 9 March 2011

MEMBER OF EOTA



## European Technical Assessment ETA-21/0043 of 2021/01/01

### I General Part

**Technical Assessment Body issuing the ETA and designated according to Article 29 of the Regulation (EU) No 305/2011: ETA-Danmark A/S**

**Trade name of the construction product:**

Protecta FR Service Transit

**Product family to which the above construction product belongs:**

Fire Stopping and Sealing Product:  
• Penetration Seals

**Manufacturer:**

Polyseam Ltd  
15 St Andrews Road  
Huddersfield  
West Yorkshire  
HD1 6SB  
United Kingdom

**Manufacturing plant:**

A/003

**This European Technical Assessment contains:**

30 pages including 2 annexes which form an integral part of the document

**This European Technical Assessment is issued in accordance with Regulation (EU) No 305/2011, on the basis of:**

EAD 350454-00-1104, September 2017

**This version replaces:**

-

**Translations of this European Technical Assessment in other languages shall fully correspond to the original issued document and should be identified as such.**

**Communication of this European Technical Assessment, including transmission by electronic means, shall be in full. However, partial reproduction may be made, with the written consent of the issuing Technical Assessment Body. Any partial reproduction has to be identified as such.**

**Table of Contents**

<b>I.</b>	<b>SPECIFIC PARTS OF THE EUROPEAN TECHNICAL ASSESSMENT .....</b>	<b>4</b>
1	Technical description of the product .....	4
2	Specification of the intended uses of the product in accordance with the applicable European Assessment Document (Hereinafter EAD): EAD 350454-00-1104.....	5
3	Performance of the product and references to the methods used for its assessment .....	6
4	ASSESSMENT AND VERIFICATION OF CONSTANCY OF PERFORMANCE (HEREINAFTER AVCP) SYSTEM APPLIED, WITH REFERENCE TO ITS LEGAL BASE.....	7
5	Technical details necessary for the implementation of the AVCP system, as provided for in the applicable EAD .....	7
	<b>ANNEX A – Resistance to Fire Classification – Protecta FR Service Transit.....</b>	<b>8</b>
A.1	Flexible or rigid wall constructions with wall thickness of minimum 75 mm .....	8
A.1.1	Penetration seals, in drywalls (min. 1 x 12.5 mm board per side) and concrete/masonry walls.....	8
A.2	Flexible or rigid wall constructions with wall thickness of minimum 100 mm .....	10
A.2.1	Penetration seals, in drywalls (min. 2 x 12.5 mm board per side) and concrete/masonry walls.....	10
A.2.2	Penetration seals, in 100 mm thick Protecta FR Board 1-S seals in drywalls (min. 2 x 12.5 mm board per side) and concrete/masonry walls.....	12
A.3	Flexible or rigid wall constructions with wall thickness of minimum 120 mm .....	14
A.3.1	Penetration seals, in drywalls (min. 2 x 15 mm board per side) and concrete/masonry walls.....	14
A.4	Rigid walls constructions with wall thickness of minimum 150 mm .....	15
A.4.1	Penetration seals in concrete/masonry walls .....	15
A.4.2	Penetration seals, in 150 mm thick Protecta FR Board 2-S seals (including 30 mm air gap) in concrete/masonry walls .....	17
A.5	Timber wall constructions with wall thickness of minimum 100 mm.....	18
A.5.1	Penetration seals in timber walls .....	18
A.6	Rigid floor constructions with thickness of minimum 150 mm .....	20
A.6.1	Penetration seals in concrete/masonry floors .....	20
A.6.2	Penetration seals, in 50 mm thick Protecta EX Mortar seals (with 50 mm stone wool backer) in concrete/masonry floors .	23
A.7	Timber floor constructions with floor thickness of minimum 150 mm .....	25
A.7.1	Penetration seals in timber floors .....	25
	<b>ANNEX B – Air Permeability – Protecta FR Service Transit .....</b>	<b>27</b>

**I. SPECIFIC PARTS OF THE EUROPEAN TECHNICAL ASSESSMENT**

**1 Technical description of the product**

- 1) Protecta FR Service Transit is a cable box device used to form penetration seals where cables, plastic pipes and conduits penetrate walls and floors.
- 2) The Protecta FR Service Transit is supplied with intumescent liner complete within a two part Polypropylene shell, to be closed around the services and inserted into the aperture in the supporting element. Protecta FR Service Transit is also supplied as a single pipe. Services can be inserted through the product and removed after it has been installed.
- 3) The applicant has submitted a written declaration that the product and/or constituents of the product contains no substances which have been classified as dangerous according to Directive 67/548/EEC and Regulation (EC) No. 1272/2008 and listed in the 'indicative list on dangerous substances' of the EGDS – taking into account the installation conditions of the construction product and the release scenarios resulting from there.

In addition to the specific clauses relating to dangerous substances contained in this European Technical Assessment, there may be other requirements applicable to the products falling within its scope (e.g. transposed European legislation and national laws, regulations and administrative provisions). In order to meet the provisions of the Construction Products Regulation, these requirements need also to be complied with, when and where they apply.

- 4) The use category of Protecta FR Service Transit in relation to BWR 3 (Hygiene, health and environment) is IA1, S/W2.

**2 Specification of the intended uses of the product in accordance with the applicable European Assessment Document (Hereinafter EAD): EAD 350454-00-1104**

Detailed information and data is given in Annex A.

The intended use of system Protecta FR Service Transit is to reinstate the fire resistance performance of flexible wall, rigid wall and floor constructions, and timber wall and floor constructions, where they are penetrated by services.

- 1) The specific elements of construction that the system Protecta FR Service Transit may be used to provide a penetration seal in, are as follows:

Flexible walls: The wall must have a minimum thickness of 75 mm and comprise steel or timber studs\* lined on both faces with minimum 1 layer of 12.5 mm thick boards.

Rigid walls: The wall must have a minimum thickness of 75 mm and comprise concrete, aerated concrete or masonry, with a minimum density of 650 kg/m<sup>3</sup>.

Timber walls: The wall must have a minimum thickness of 100 mm and comprise solid wood or cross-laminated timber

Rigid floors: The floor must have a minimum thickness of 150 mm and comprise aerated concrete or concrete with a minimum density of 650 kg/m<sup>3</sup>.

Timber floors: The floor must have a minimum thickness of 150 mm and comprise solid wood or cross-laminated timber.

\* no part of the penetration seal may be closer than 100 mm to a stud, the cavity must be closed between the penetration seal and the stud, and minimum 100 mm of insulation of class A1 or A2 according to EN 13501-1 must be provided within the cavity between the penetration seal and the stud.

The supporting construction must be classified in accordance with EN 13501-2 for the required fire resistance period.

- 2) The system Protecta FR Service Transit may be used to provide a penetration seal with specific supporting constructions and substrates (for details see Annex A).
- 3) The provisions made in this European Technical Assessment are based on an assumed working life of the Protecta FR Service Transit of 30 years, provided that the conditions laid down in the manufacturers datasheet and instructions for the packaging/transport/storage/installation/use/repair are met. The indications given on the working life cannot be interpreted as a guarantee given by the producer or the Technical Assessment Body but are to be regarded only as a means for choosing the right products in relation to the expected economically reasonable working life of the works.
- 4) Type Z<sub>2</sub>: intended for use at internal conditions with humidity classes other than Z<sub>1</sub>, excluding temperatures below 0°C.

**3 Performance of the product and references to the methods used for its assessment**

4

Product-type: Pipe Service Transit		Intended use: Penetration Seal
Basic requirement for construction work	Basic Requirement	Performance
<b>BWR 2 Safety in case of fire</b>		
	Reaction to fire	No performance assessed
	Resistance to fire	Annex A
<b>BWR 3 Hygiene, health and environment</b>		
	Air permeability	Annex B
	Water permeability	No performance assessed
	Content, emission and/or release of dangerous substances	Use categories: IA1, S/W2 Declaration of manufacturer
<b>BWR 4 Safety in use</b>		
	Mechanical resistance and stability	No performance assessed
	Resistance to impact/movement	No performance assessed
	Adhesion	No performance assessed
	Durability	Z <sub>2</sub>
<b>BWR 5 Protection against noise</b>		
	Airborne sound insulation	No performance assessed
<b>BWR 6 Energy economy and heat retention</b>		
	Thermal properties	No performance assessed
	Water vapour permeability	No performance assessed

**5 ASSESSMENT AND VERIFICATION OF CONSTANCY OF PERFORMANCE (HEREINAFTER AVCP) SYSTEM APPLIED, WITH REFERENCE TO ITS LEGAL BASE**

According to the decision 1999/454/EC – Commission Decision of date 22nd June 1999 on the procedure for attesting the conformity of construction products pursuant to Article 20(2) of Council Directive 89/106/EEC as regards fire stopping, fire sealing and fire protective products, published in the Official Journal of the European Union (OJEU) L178/52 of 14/07/1999, (see <https://eur-lex.europa.eu/oj/direct-access.html>) of the European Commission<sup>1</sup>, as amended, the system(s) of assessment and verification of constancy of performance (see Annex V to Regulation (EU) No 305/2011) given in the following table(s) applies (apply).

Product(s)	Intended use(s)	Level(s) or class(es)	System(s)
Fire stopping and Fire Sealing Products	For fire compartmentation and/or fire protection or fire performance	Any	1

**6 Technical details necessary for the implementation of the AVCP system, as provided for in the applicable EAD**

Technical details necessary for the implementation of the AVCP system are laid down in the control plan deposited at ETA-Danmark A/S prior to CE marking

Issued in Copenhagen on 2021-01-01 by



Thomas Bruun

Managing Director, ETA-Danmark

---

<sup>1</sup> Official Journal of the European Communities L178/52 of 14/7/1999

## ANNEX A – Resistance to Fire Classification – Protecta FR Service Transit

### A.1 Flexible or rigid wall constructions with wall thickness of minimum 75 mm

#### A.1.1 Penetration seals, in drywalls (min. 1 x 12.5 mm board per side) and concrete/masonry walls

**Penetration Seal:** Cables and conduits fitted with minimum 150 mm long Protecta FR Service Transit, central within the wall. Spaces around cables and conduits within the device are sealed with 50 mm deep Mineral Bio Wool installed centrally. Min. Separation between seals ( $a_2$ ) = 30 mm, min. Separation between transit and supporting construction ( $a_1$ ) = 0 mm.

Construction details:

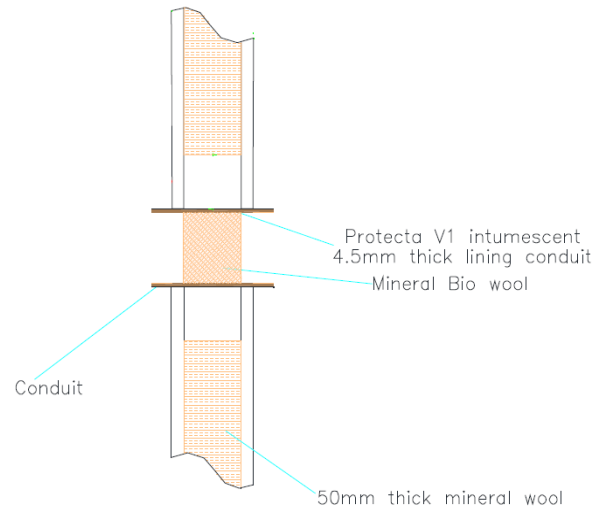
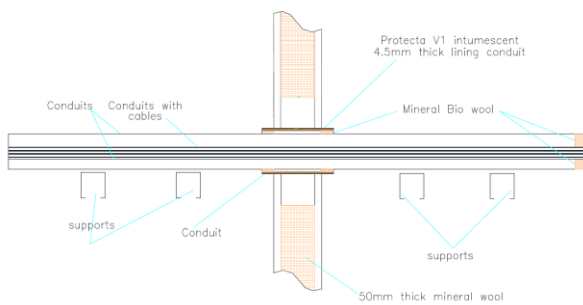

Option 1

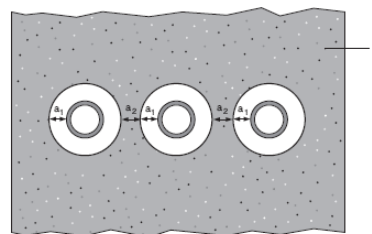

Option 2

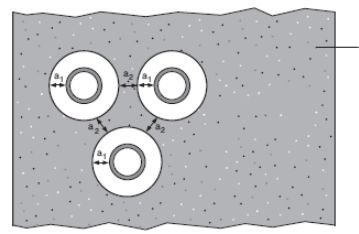

Key

- 1 Supporting construction
- $a_1$  Pipe / edge of seal separation (annular space)
- $a_2$  Separation between penetration seals

Figure E.2 — Standard configuration for single pipe penetration seals



**A.1.1.1**

<b>Services</b>	<b>Inlay size</b>	<b>Transit size</b>	<b>Classification</b>
Up to 35 mm diameter bundle of cables up to 21 mm diameter	1.5 mm thick by 150 mm long	40 mm Ø x 150 mm long	<b>EI 60</b>
Up to 50 mm diameter bundle of cables up to 21 mm diameter	2.0 mm thick by 150 mm long	63 mm Ø x 150 mm long	
Up to 80 mm diameter bundle of cables up to 21 mm diameter	4.0 mm thick by 150 mm long	90 mm Ø x 150 mm long	
Up to 100 mm diameter bundle of cables up to 21 mm diameter	4.5 mm thick by 150 mm long	110 mm Ø x 150 mm long	
Up to 100 mm diameter bundle of cables up to 80 mm diameter	All inlay sizes specified above	All transit sizes specified above	<b>E 60</b> <b>EI 45</b>
Empty filled at mid-depth with 50 mm deep plug of Mineral Bio Wool			<b>E 60</b> <b>EI 30</b>
Up to 32mm diameter plastic pipes in bundle, empty or with penetrating bundle of cables up to 14 mm diameter			<b>EI 60 U/C</b>

**A.2 Flexible or rigid wall constructions with wall thickness of minimum 100 mm**

**A.2.1 Penetration seals, in drywalls (min. 2 x 12.5 mm board per side) and concrete/masonry walls**

**Penetration Seal:** Cables and conduits fitted with minimum 250 mm long Protecta FR Service Transit, central within the wall. Spaces around cables and conduits within the device are sealed with 50 mm deep Mineral Bio Wool installed centrally. Min. Separation between seals ( $a_2$ ) = 30 mm, min. Separation between transit and supporting construction ( $a_1$ ) = 0 mm A.2.1.1 and minimum 10 mm with maximum aperture 300 x 300mm A.2.1.2.

Construction details:

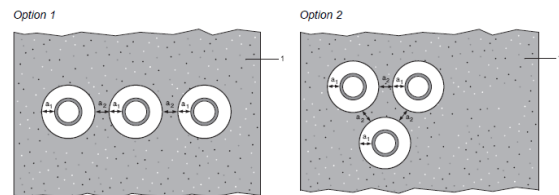
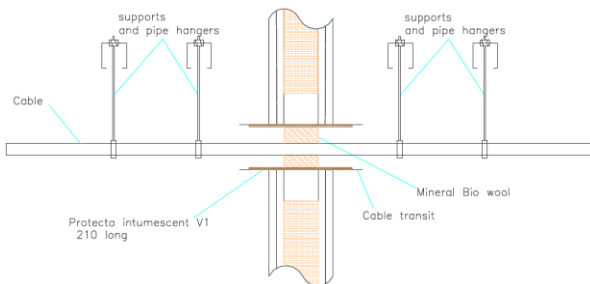
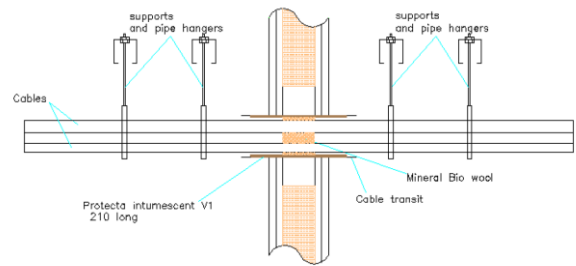
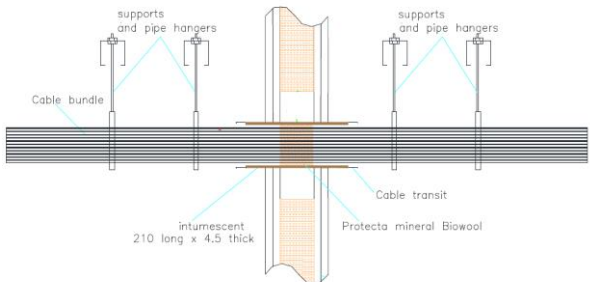
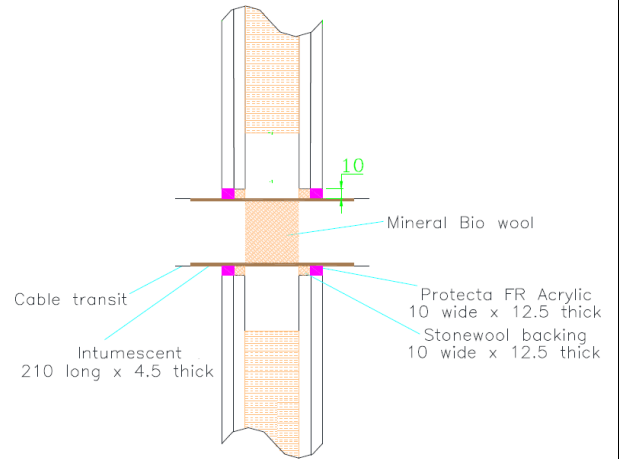
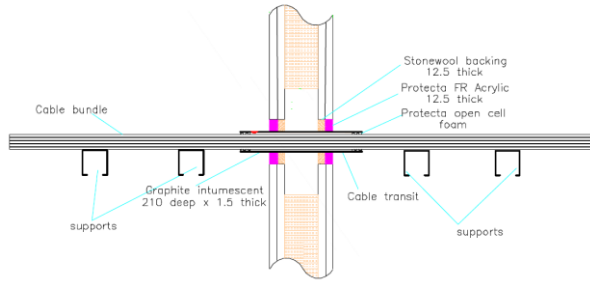

**Key**  
 1 Supporting construction  
 $a_1$  Pipe / edge of seal separation (annular space)  
 $a_2$  Separation between penetration seals

Figure E.2 — Standard configuration for single pipe penetration seals

**A.2.1.1 – FR Service transit friction fitted into wall**

Services	Inlay size	Transit size	Classification
Up to 35 mm diameter bundle of cables up to 21 mm diameter	1.5 mm thick by 210 mm long	40 mm Ø x 250 mm long	EI 90
Up to 35 mm diameter bundle of cables up to 35 mm diameter	1.5 mm thick by 210 mm long	40 mm Ø x 250 mm long	E 90 EI 60
Up to 50 mm diameter bundle of cables up to 21 mm diameter	2.0 mm thick by 210 mm long	63 mm Ø x 250 mm long	EI 90
Up to 50 mm diameter bundle of cables up to 50 mm diameter	2.0 mm thick by 210 mm long	63 mm Ø x 250 mm long	E 90 EI 60
Up to 80 mm diameter bundle of cables up to 21 mm diameter	4.0 mm thick by 210 mm long	90 mm Ø x 250 mm long	EI 90
Up to 80 mm diameter bundle of cables up to 80 mm diameter	4.0 mm thick by 210 mm long	90 mm Ø x 250 mm long	E 90 EI 60
Up to 100 mm diameter bundle of cables up to 21 mm diameter	4.5 mm thick by 210 mm long	110 mm Ø x 250 mm long	EI 90
Up to 100 mm diameter bundle of cables up to 80 mm diameter	4.5 mm thick by 210 mm long	110 mm Ø x 250 mm long	E 90 EI 60
Empty filled at mid-depth with 50 mm deep plug of Mineral Bio Wool	All inlay sizes specified above	All transit sizes specified above	E 90 EI 60
Up to 32mm diameter plastic pipes in bundle, empty or with penetrating bundle of cables up to 21 mm diameter			EI 90 U/C

**A.2.1.2 – FR Service Transit in minimum 20 mm oversize aperture fitted with Protecta FR Acrylic.**

Services	Inlay size	Transit size	Classification
Up to 35 mm diameter bundle of cables up to 21 mm diameter	1.5 mm thick by 210 mm long	40 mm Ø x 250 mm long	EI 90
Up to 35 mm diameter bundle of cables up to 35 mm diameter	1.5 mm thick by 210 mm long	40 mm Ø x 250 mm long	E 90 EI 60
Up to 50 mm diameter bundle of cables up to 21 mm diameter	2.0 mm thick by 210 mm long	63 mm Ø x 250 mm long	EI 90
Up to 50 mm diameter bundle of cables up to 50 mm diameter	2.0 mm thick by 210 mm long	63 mm Ø x 250 mm long	E 90 EI 60
Up to 80 mm diameter bundle of cables up to 21 mm diameter	4.0 mm thick by 210 mm long	90 mm Ø x 250 mm long	EI 90
Up to 80 mm diameter bundle of cables up to 80 mm diameter	4.0 mm thick by 210 mm long	90 mm Ø x 250 mm long	E 90 EI 60
Up to 100 mm diameter bundle of cables up to 21 mm diameter	4.5 mm thick by 210 mm long	110 mm Ø x 250 mm long	EI 90
Up to 100 mm diameter bundle of cables up to 80 mm diameter	4.5 mm thick by 210 mm long	110 mm Ø x 250 mm long	E 90 EI 60
Empty filled at mid-depth with 50 mm deep plug of Mineral Bio Wool	All inlay sizes specified above	All transit sizes specified above	EI 90
Up to 32mm diameter plastic pipes in bundle, empty or with penetrating bundle of cables up to 21 mm diameter			EI 90 U/C

**A.2.2 Penetration seals, in 100 mm thick Protecta FR Board 1-S seals in drywalls (min. 2 x 12.5 mm board per side) and concrete/masonry walls**

**Penetration Seal:** Cables and conduits fitted with minimum 250 mm long Protecta FR Service Transit, central within the seal. Spaces around cables and conduits within the device are sealed with 50 mm deep Mineral Bio Wool installed centrally. Min. Separation between transits and between transits and the edges of the board seal ( $a_1$ ,  $a_2$ ,  $a_3$ ) = 30 mm, min.

Construction details:

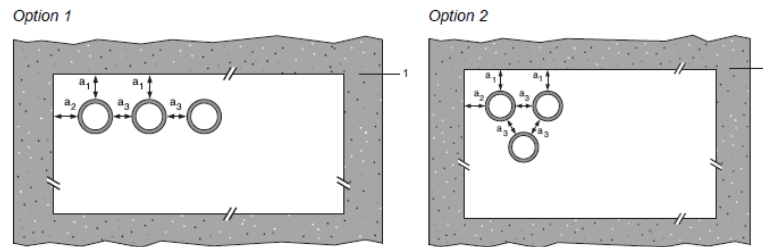
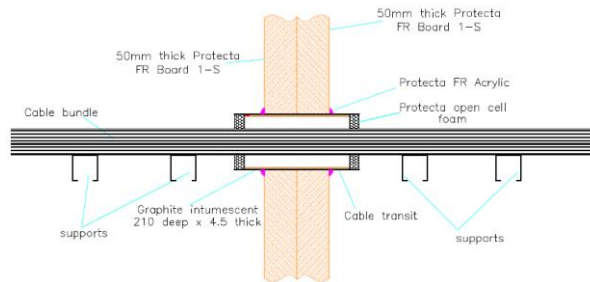

- Key**
- 1 Supporting construction
  - $a_1$  Pipe / top edge of seal separation
  - $a_2$  Pipe / side edge of seal separation
  - $a_3$  Pipe / pipe separation

**Figure E.1 — Standard configuration for multiple pipe penetration seals**

**A.2.2.1**

<b>Services</b>	<b>Inlay size</b>	<b>Transit size</b>	<b>Classification</b>
Up to 35 mm diameter bundle of cables up to 21 mm diameter	1.5 mm thick by 210 mm long	40 mm $\varnothing$ x 250 mm long	<b>EI 90</b>
Up to 35 mm diameter bundle of cables up to 35 mm diameter	1.5 mm thick by 210 mm long	40 mm $\varnothing$ x 250 mm long	<b>E 90</b> <b>EI 60</b>
Up to 50 mm diameter bundle of cables up to 21 mm diameter	2.0 mm thick by 210 mm long	63 mm $\varnothing$ x 250 mm long	<b>EI 90</b>
Up to 50 mm diameter bundle of cables up to 50 mm diameter	2.0 mm thick by 210 mm long	63 mm $\varnothing$ x 250 mm long	<b>E 90</b> <b>EI 60</b>
Up to 80 mm diameter bundle of cables up to 21 mm diameter	4.0 mm thick by 210 mm long	90 mm $\varnothing$ x 250 mm long	<b>EI 90</b>
Up to 80 mm diameter bundle of cables up to 80 mm diameter	4.0 mm thick by 210 mm long	90 mm $\varnothing$ x 250 mm long	<b>E 90</b> <b>EI 60</b>
Up to 100 mm diameter bundle of cables up to 21 mm diameter	4.5 mm thick by 210 mm long	110 mm $\varnothing$ x 250 mm long	<b>EI 90</b>
Up to 100 mm diameter bundle of cables up to 80 mm diameter	4.5 mm thick by 210 mm long	110 mm $\varnothing$ x 250 mm long	<b>E 90</b> <b>EI 60</b>
Empty filled at mid-depth with 50 mm deep plug of Mineral Bio Wool	All inlay sizes specified above	All transit sizes specified above	<b>E 90</b> <b>EI 60</b>
Up to 32mm diameter plastic pipes in bundle, empty or with penetrating bundle of cables up to 21 mm diameter			<b>EI 90 U/C</b>

### A.3 Flexible or rigid wall constructions with wall thickness of minimum 120 mm

#### A.3.1 Penetration seals, in drywalls (min. 2 x 15 mm board per side) and concrete/masonry walls

**Penetration Seal:** Cables and conduits fitted with minimum 250 mm long Protecta FR Service Transit, central within the wall. Spaces around cables and conduits within the device are sealed with 50 mm deep Mineral Bio Wool installed centrally. Min. Separation between seals ( $a_2$ ) = 30 mm, min. Separation between transit and supporting construction ( $a_1$ ) = 0 mm.

Construction details:

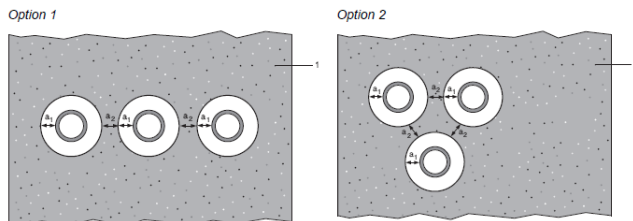
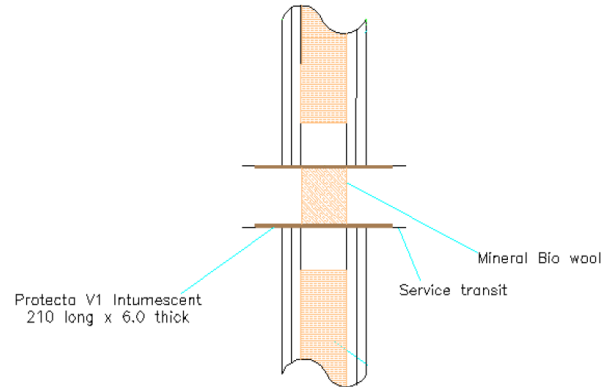
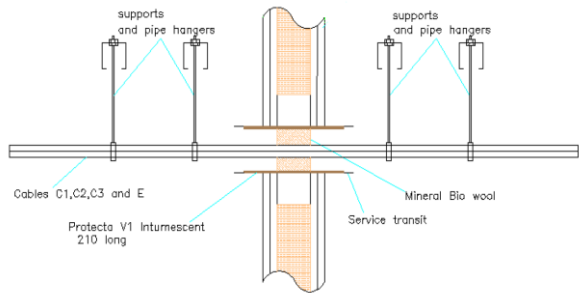

**Key**  
 1 Supporting construction  
 $a_1$  Pipe / edge of seal separation (annular space)  
 $a_2$  Separation between penetration seals

Figure E.2 — Standard configuration for single pipe penetration seals

#### A.3.1.1 – FR Service transit friction fitted into wall

Services	Inlay size	Transit size	Classification
Up to 35 mm diameter bundle of cables up to 21 mm diameter	1.5 mm thick by 210 mm long	40 mm $\varnothing$ x 250 mm long	EI 120
Up to 35 mm diameter bundle of cables up to 35 mm diameter	1.5 mm thick by 210 mm long	40 mm $\varnothing$ x 250 mm long	E 120 EI 90
Up to 50 mm diameter bundle of cables up to 21 mm diameter	2.0 mm thick by 210 mm long	63 mm $\varnothing$ x 250 mm long	EI 120
Up to 50 mm diameter bundle of cables up to 50 mm diameter	2.0 mm thick by 210 mm long	63 mm $\varnothing$ x 250 mm long	E 120 EI 90
Up to 80 mm diameter bundle of cables up to 21 mm diameter	4.0 mm thick by 210 mm long	90 mm $\varnothing$ x 250 mm long	EI 120
Up to 80 mm diameter bundle of cables up to 50 mm diameter	4.0 mm thick by 210 mm long	90 mm $\varnothing$ x 250 mm long	E 120 EI 90
Up to 100 mm diameter bundle of cables up to 21 mm diameter	4.5 mm thick by 210 mm long	110 mm $\varnothing$ x 250 mm long	EI 120
Up to 100 mm diameter bundle of cables up to 50 mm diameter	4.5 mm thick by 210 mm long	110 mm $\varnothing$ x 250 mm long	E 120 EI 90
Empty filled at mid-depth with 50 mm deep plug of Mineral Bio Wool	All inlay sizes specified above	All transit sizes specified above	E 120 EI 90

## A.4 Rigid walls constructions with wall thickness of minimum 150 mm

### A.4.1 Penetration seals in concrete/masonry walls

**Penetration Seal:** Cables and conduits fitted with minimum 250 mm long Protecta FR Service Transit, central within the wall. Spaces around cables and conduits within the device are sealed with 50 mm deep Mineral Bio Wool installed centrally. Min. Separation between seals ( $a_2$ ) = 30 mm, min. Separation between transit and supporting construction ( $a_1$ ) = 0 mm A.4.1.1 and minimum 10 mm with maximum aperture 300 x 300mm A.4.1.2.

#### Construction details:

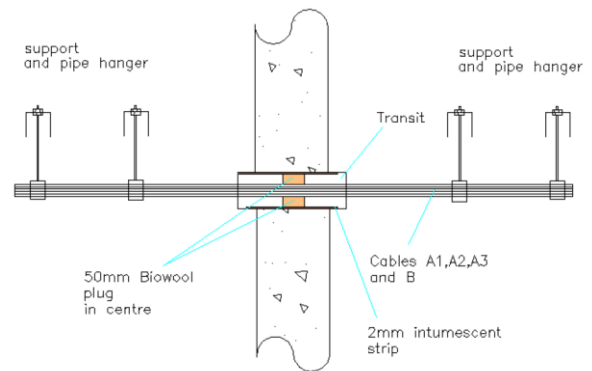
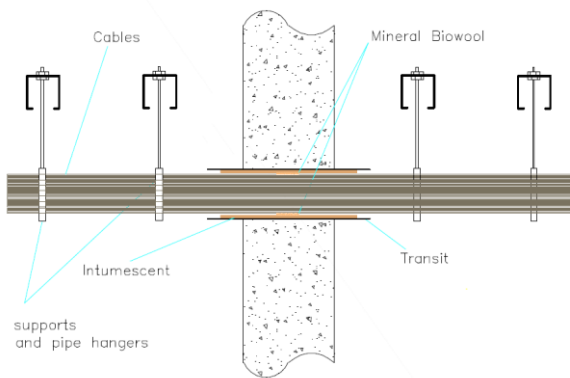
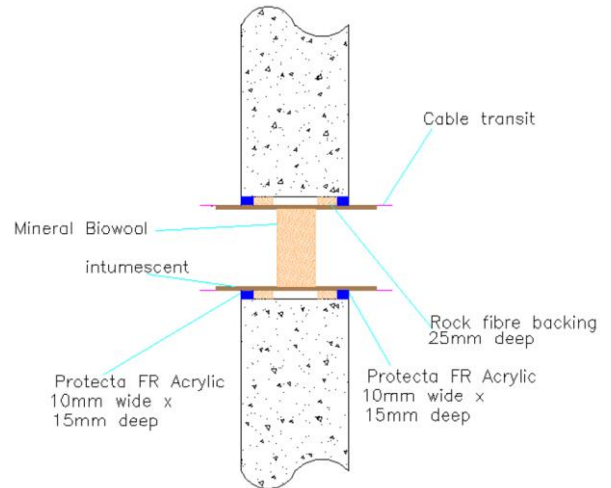
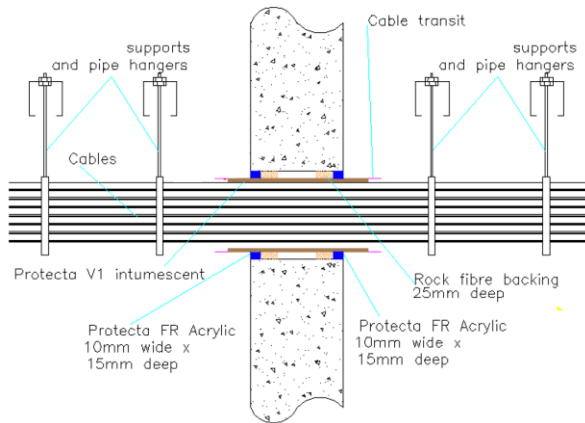

Option 1

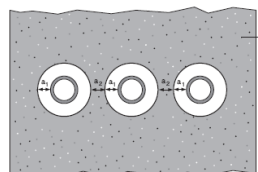

Option 2

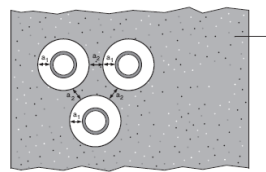

**Key**

- 1 Supporting construction
- $a_1$  Pipe / edge of seal separation (annular space)
- $a_2$  Separation between penetration seals

Figure E.2 — Standard configuration for single pipe penetration seals

**A.4.1.1 – FR Service Transit friction fitted into wall**

Services	Inlay size	Transit size	Classification
Up to 35 mm diameter bundle of cables up to 21 mm diameter	1.5 mm thick by 210 mm long	40 mm Ø x 250 mm long	<b>EI 240</b>
Up to 50 mm diameter bundle of cables up to 21 mm diameter	2.0 mm thick by 210 mm long	63 mm Ø x 250 mm long	
Up to 80 mm diameter bundle of cables up to 21 mm diameter	4.0 mm thick by 210 mm long	90 mm Ø x 250 mm long	
Up to 100 mm diameter bundle of cables up to 21 mm diameter	4.5 mm thick by 210 mm long	110 mm Ø x 250 mm long	<b>E 240</b> <b>EI 180</b>
Empty filled at mid-depth with 50 mm deep plug of Mineral Bio Wool	All inlay sizes specified above	All transit sizes specified above	<b>E 240</b> <b>EI 90</b>
Up to 32mm diameter plastic pipes in bundle, empty or with penetrating bundle of cables up to 21 mm diameter			<b>EI 240 U/C</b>

**A.4.1.2 – FR Service Transit in minimum 20 mm oversize aperture fitted with Protecta FR Acrylic.**

Services	Inlay size	Transit size	Classification
Up to 35 mm diameter bundle of cables up to 21 mm diameter	1.5 mm thick by 210 mm long	40 mm Ø x 250 mm long	<b>EI 240</b>
Up to 50 mm diameter bundle of cables up to 21 mm diameter	2.0 mm thick by 210 mm long	63 mm Ø x 250 mm long	
Up to 80 mm diameter bundle of cables up to 21 mm diameter	4.0 mm thick by 210 mm long	90 mm Ø x 250 mm long	
Up to 100 mm diameter bundle of cables up to 21 mm diameter	4.5 mm thick by 210 mm long	110 mm Ø x 250 mm long	<b>E 240</b> <b>EI 180</b>
Empty filled at mid-depth with 50 mm deep plug of Mineral Bio Wool	All inlay sizes specified above	All transit sizes specified above	<b>E 240</b> <b>EI 90</b>
Up to 32mm diameter plastic pipes in bundle, empty or with penetrating bundle of cables up to 21 mm diameter			<b>EI 240 U/C</b>



### A.4.2 Penetration seals, in 150 mm thick Protecta FR Board 2-S seals (including 30 mm air gap) in concrete/masonry walls

**Penetration Seal:** Cables and conduits fitted with minimum 250 mm long Protecta FR Service Transit, central within the seal. Spaces around cables and conduits within the device are sealed with 50 mm deep Mineral Bio Wool installed centrally. Min. Separation between transits and between transits and the edges of the board seal ( $a_1$ ,  $a_2$ ,  $a_3$ ) = 30 mm, min.

Construction details:

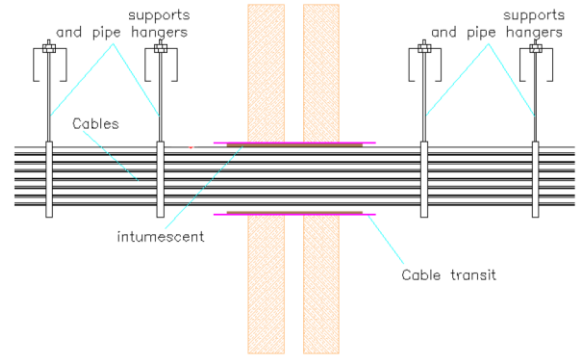
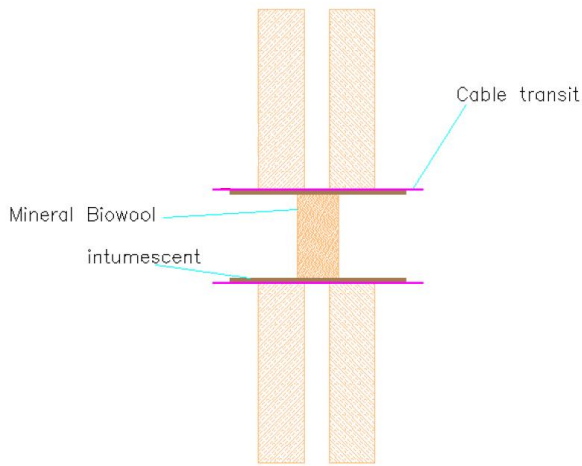

Option 1

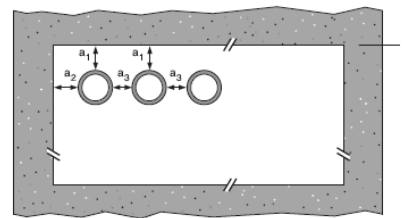

Option 2

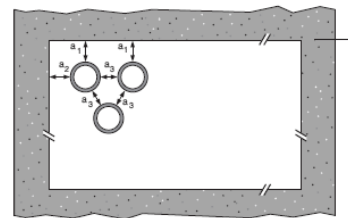

Key

- 1 Supporting construction
- $a_1$  Pipe / top edge of seal separation
- $a_2$  Pipe / side edge of seal separation
- $a_3$  Pipe / pipe separation

Figure E.1 — Standard configuration for multiple pipe penetration seals

#### A.4.2.1

Services	Inlay size	Transit size	Classification
Up to 35 mm diameter bundle of cables up to 21 mm diameter	1.5 mm thick by 210 mm long	40 mm $\varnothing$ x 250 mm long	E 240 EI 180
Up to 50 mm diameter bundle of cables up to 21 mm diameter	2.0 mm thick by 210 mm long	63 mm $\varnothing$ x 250 mm long	E 180 EI 120
Up to 80 mm diameter bundle of cables up to 21 mm diameter	4.0 mm thick by 210 mm long	90 mm $\varnothing$ x 250 mm long	E 240 EI 120
Up to 100 mm diameter bundle of cables up to 21 mm diameter	4.5 mm thick by 210 mm long	110 mm $\varnothing$ x 250 mm long	E 240 EI 90
Empty filled at mid-depth with 50 mm deep plug of Mineral Bio Wool	All inlay sizes specified above	All transit sizes specified above	EI 90 U/C
Up to 32mm diameter plastic pipes in bundle, empty or with penetrating bundle of cables up to 21 mm diameter			

## A.5 Timber wall constructions with wall thickness of minimum 100 mm

### A.5.1 Penetration seals in timber walls

**Penetration Seal:** Cables fitted with minimum 250 mm long Protecta FR Service Transit central within the wall. The annular space around the Service Transit is sealed with Protecta FR Acrylic, minimum 25 mm deep to both sides of the wall backed with Stonewool (minimum 33kg/m<sup>3</sup> density), minimum 25 mm deep. Spaces around cables within the device are sealed with 50 mm deep Mineral Bio Wool installed centrally. Min. Separation between seals (a2) = 30 mm, min. Minimum separation between transit and supporting construction (a1) = 10 mm. Maximum aperture size is  $\varnothing$  180mm.

Construction details:

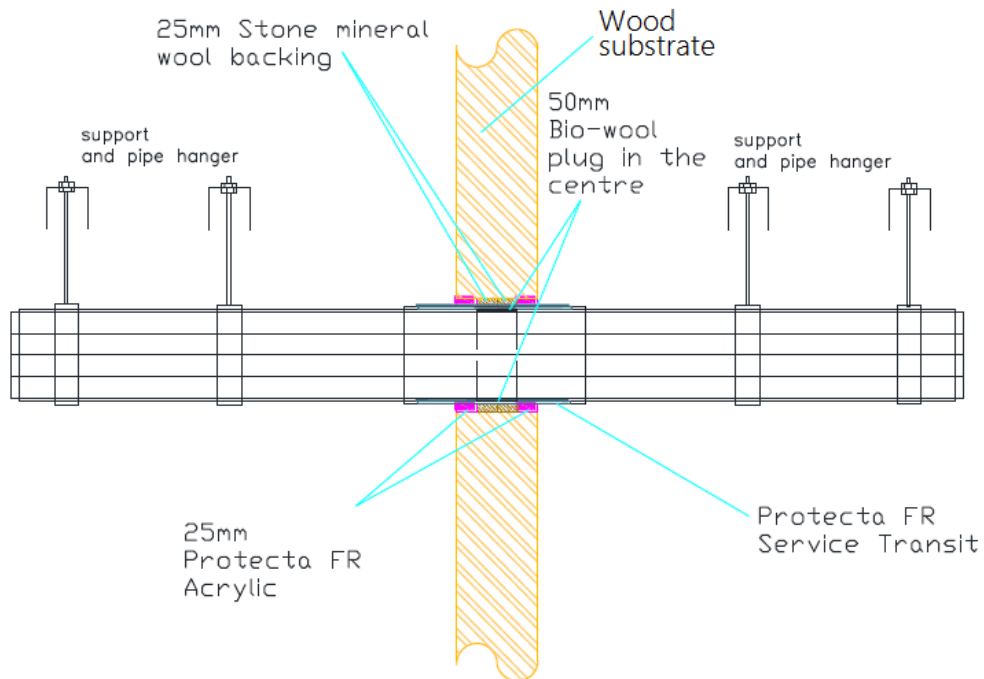

### Configuration 1

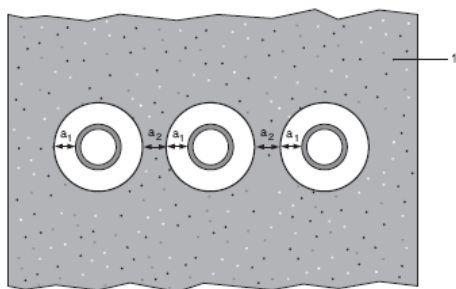

#### Key

1 Supporting construction

a1 Pipe / edge of seal separation (annular space)

a2 Separation between penetration seals

**A.5.1.1**

<b>Services</b>	<b>Inlay size</b>	<b>Transit size</b>	<b>Classification</b>
Up to 35 mm diameter bundle of cables up to 21 mm diameter	1.5 mm thick by 210 mm long	40 mm Ø x 250 mm long	<b>EI 90</b>
Up to 35 mm diameter bundle of cables up to 35 mm diameter	1.5 mm thick by 210 mm long	40 mm Ø x 250 mm long	<b>E 90</b> <b>EI 60</b>
Up to 50 mm diameter bundle of cables up to 21 mm diameter	2.0 mm thick by 210 mm long	63 mm Ø x 250 mm long	<b>EI 90</b>
Up to 50 mm diameter bundle of cables up to 50 mm diameter	2.0 mm thick by 210 mm long	63 mm Ø x 250 mm long	<b>E 90</b> <b>EI 60</b>
Up to 80 mm diameter bundle of cables up to 21 mm diameter	4.0 mm thick by 210 mm long	90 mm Ø x 250 mm long	<b>EI 90</b>
Up to 80 mm diameter bundle of cables up to 80 mm diameter	4.0 mm thick by 210 mm long	90 mm Ø x 250 mm long	<b>E 90</b> <b>EI 60</b>
Up to 100 mm diameter bundle of cables up to 21 mm diameter	4.5 mm thick by 210 mm long	110 mm Ø x 250 mm long	<b>EI 90</b>
Up to 100 mm diameter bundle of cables up to 80 mm diameter	4.5 mm thick by 210 mm long	110 mm Ø x 250 mm long	<b>E 90</b> <b>EI 60</b>
Empty filled at mid-depth with 50 mm deep plug of Mineral Bio Wool	All inlay sizes specified above	All transit sizes specified above	<b>EI 90</b>
Up to 32mm diameter plastic pipes in bundle, empty or with penetrating bundle of cables up to 21 mm diameter			<b>EI 90 U/C</b>

## A.6 Rigid floor constructions with thickness of minimum 150 mm

### A.6.1 Penetration seals in concrete/masonry floors

**Penetration Seal:** Cables and conduits fitted with minimum 250 mm long Protecta FR Service Transit, central within the floor. Spaces around cables and conduits within the device are sealed with 50 mm deep Mineral Bio Wool installed centrally. Min. Separation between seals ( $a_2$ ) = 30 mm, min. Separation between transit and supporting construction ( $a_1$ ) = 0 mm A.5.1.1 and minimum 10 mm with maximum aperture 300 x 300mm A.5.1.2.

Construction details:

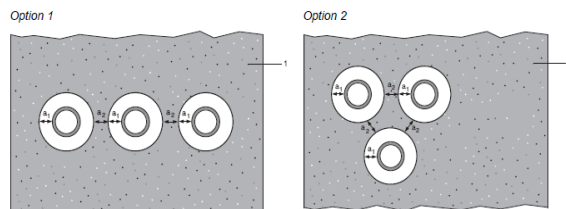
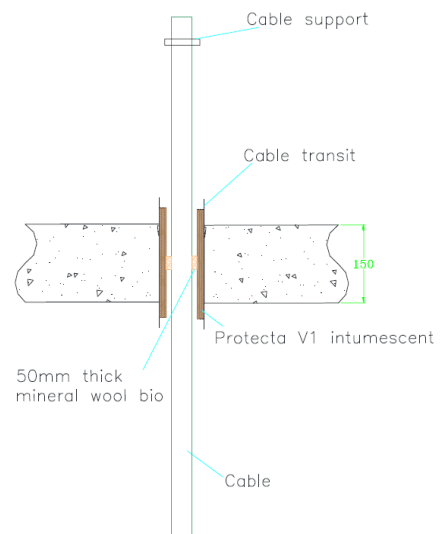
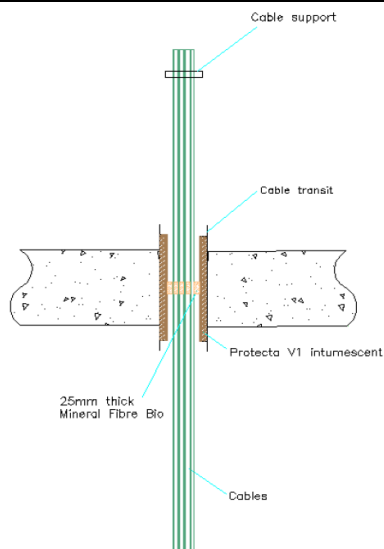
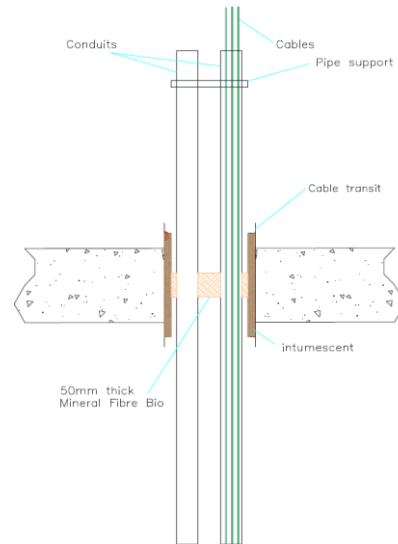
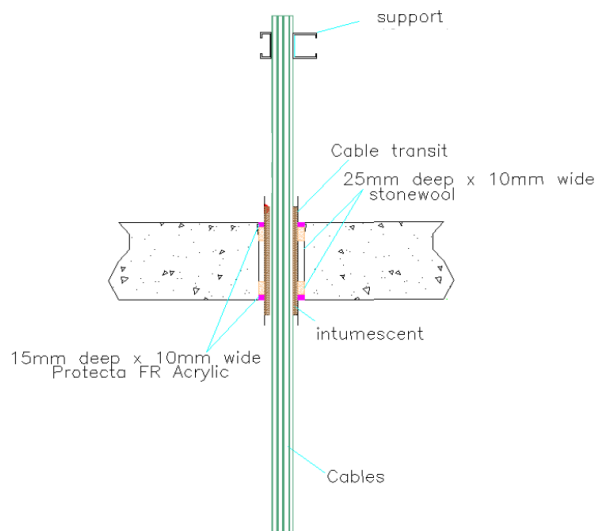

**Key**  
 1 Supporting construction  
 $a_1$  Pipe / edge of seal separation (annular space)  
 $a_2$  Separation between penetration seals

Figure E.2 — Standard configuration for single pipe penetration seals

**A.6.1.1 – FR Service transit friction fitted into floor**

Services	Inlay size	Transit size	Classification
Up to 35 mm diameter bundle of cables up to 21 mm diameter	1.5 mm thick by 210 mm long	40 mm Ø x 250 mm long	<b>EI 180</b>
Up to 35 mm diameter bundle of cables up to 35 mm diameter	1.5 mm thick by 210 mm long	40 mm Ø x 250 mm long	<b>E 180 EI 60</b>
Up to 50 mm diameter bundle of cables up to 21 mm diameter	2.0 mm thick by 210 mm long	63 mm Ø x 250 mm long	<b>EI 180</b>
Up to 50 mm diameter bundle of cables up to 50 mm diameter	2.0 mm thick by 210 mm long	63 mm Ø x 250 mm long	<b>E 180 EI 60</b>
Up to 80 mm diameter bundle of cables up to 21 mm diameter	4.0 mm thick by 210 mm long	90 mm Ø x 250 mm long	<b>EI 180</b>
Up to 80 mm diameter bundle of cables up to 50 mm diameter	4.0 mm thick by 210 mm long	90 mm Ø x 250 mm long	<b>E 180 EI 60</b>
Up to 80 mm diameter bundle of cables up to 80 mm diameter	4.0 mm thick by 210 mm long	90 mm Ø x 250 mm long	<b>E 90 EI 60</b>
Up to 100 mm diameter bundle of cables up to 21 mm diameter	4.5 mm thick by 210 mm long	110 mm Ø x 250 mm long	<b>EI 180</b>
Up to 100 mm diameter bundle of cables up to 50 mm diameter	4.5 mm thick by 210 mm long	110 mm Ø x 250 mm long	<b>E 180 EI 60</b>
Up to 100 mm diameter bundle of cables up to 80 mm diameter	4.5 mm thick by 210 mm long	110 mm Ø x 250 mm long	<b>E 90 EI 60</b>
Empty filled at mid-depth with 50 mm deep plug of Mineral Bio Wool	All inlay sizes specified above	All transit sizes specified above	<b>E 240 EI 180</b>
Up to 32mm diameter plastic pipes in bundle, empty or with penetrating bundle of cables up to 21 mm diameter			<b>E 120 C/U EI 60 C/U</b>
			<b>EI 180 C/U</b>

**A.6.1.2 – FR Service Transit in minimum 20 mm oversize aperture fitted with Protecta FR Acrylic.**

Services	Inlay size	Transit size	Classification
Up to 35 mm diameter bundle of cables up to 14 mm diameter	1.5 mm thick by 210 mm long	40 mm Ø x 250 mm long	EI 240
Up to 35 mm diameter bundle of cables up to 21 mm diameter	1.5 mm thick by 210 mm long	40 mm Ø x 250 mm long	E 240 EI 180
Up to 35 mm diameter bundle of cables up to 35 mm diameter	1.5 mm thick by 210 mm long	40 mm Ø x 250 mm long	E 240 EI 60
Up to 50 mm diameter bundle of cables up to 21 mm diameter	2.0 mm thick by 210 mm long	63 mm Ø x 250 mm long	E 240 EI 180
Up to 50 mm diameter bundle of cables up to 50 mm diameter	2.0 mm thick by 210 mm long	63 mm Ø x 250 mm long	E 240 EI 60
Up to 80 mm diameter bundle of cables up to 14 mm diameter	4.0 mm thick by 210 mm long	90 mm Ø x 250 mm long	EI 240
Up to 80 mm diameter bundle of cables up to 21 mm diameter	4.0 mm thick by 210 mm long	90 mm Ø x 250 mm long	E 240 EI 180
Up to 80 mm diameter bundle of cables up to 50 mm diameter	4.0 mm thick by 210 mm long	90 mm Ø x 250 mm long	E 240 EI 60
Up to 80 mm diameter bundle of cables up to 80 mm diameter	4.0 mm thick by 210 mm long	90 mm Ø x 250 mm long	E 90 EI 60
Up to 100 mm diameter bundle of cables up to 21 mm diameter	4.5 mm thick by 210 mm long	110 mm Ø x 250 mm long	EI 180
Up to 100 mm diameter bundle of cables up to 50 mm diameter	4.5 mm thick by 210 mm long	110 mm Ø x 250 mm long	E 180 EI 60
Up to 100 mm diameter bundle of cables up to 80 mm diameter	4.5 mm thick by 210 mm long	110 mm Ø x 250 mm long	E 90 EI 60
Empty filled at mid-depth with 50 mm deep plug of Mineral Bio Wool	All inlay sizes specified above	All transit sizes specified above	E 240 EI 180
Up to 32mm diameter plastic pipes in bundle, empty or with penetrating bundle of cables up to 21 mm diameter			E 120 C/U EI 60 C/U
			EI 180 C/U

### A.6.2 Penetration seals, in 50 mm thick Protecta EX Mortar seals (with 50 mm stone wool backer) in concrete/masonry floors

**Penetration Seal:** Cables and conduits fitted with 250 mm long Protecta FR Service Transit, central within the seal. Spaces around cables and conduits within the device are sealed with 50 mm deep Mineral Bio Wool installed centrally. Min. Separation between transits and between transits and the edges of the board seal ( $a_1$ ,  $a_2$ ,  $a_3$ ) = 30 mm, min.

#### Construction details:

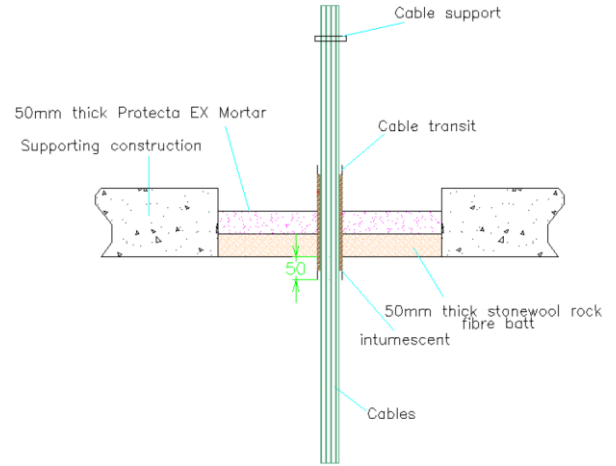
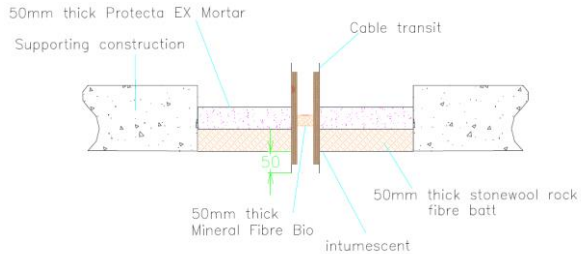

Option 1

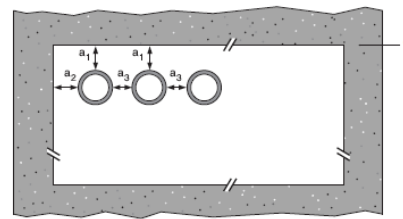

Option 2

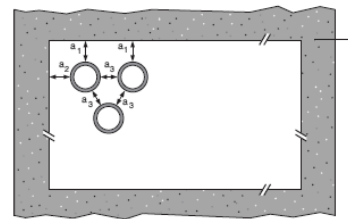

**Key**

- 1 Supporting construction
- $a_1$  Pipe / top edge of seal separation
- $a_2$  Pipe / side edge of seal separation
- $a_3$  Pipe / pipe separation

**Figure E.1 — Standard configuration for multiple pipe penetration seals**

**A.6.2.1**

<b>Services</b>	<b>Inlay size</b>	<b>Transit size</b>	<b>Classification</b>
Up to 35 mm diameter bundle of cables up to 14 mm diameter	1.5 mm thick by 210 mm long	40 mm Ø x 250 mm long	<b>EI 240</b>
Up to 35 mm diameter bundle of cables up to 21 mm diameter	1.5 mm thick by 210 mm long	40 mm Ø x 250 mm long	<b>E 240 EI 180</b>
Up to 35 mm diameter bundle of cables up to 35 mm diameter	1.5 mm thick by 210 mm long	40 mm Ø x 250 mm long	<b>E 240 EI 60</b>
Up to 50 mm diameter bundle of cables up to 21 mm diameter	2.0 mm thick by 210 mm long	63 mm Ø x 250 mm long	<b>EI 180</b>
Up to 50 mm diameter bundle of cables up to 50 mm diameter	2.0 mm thick by 210 mm long	63 mm Ø x 250 mm long	<b>E 180 EI 60</b>
Up to 50 mm diameter bundle of cables up to 80 mm diameter	2.0 mm thick by 210 mm long	63 mm Ø x 250 mm long	<b>E 90 EI 60</b>
Up to 80 mm diameter bundle of cables up to 21 mm diameter	4.0 mm thick by 210 mm long	90 mm Ø x 250 mm long	<b>E 240 EI 120</b>
Up to 80 mm diameter bundle of cables up to 50 mm diameter	4.0 mm thick by 210 mm long	90 mm Ø x 250 mm long	<b>E 240 EI 60</b>
Up to 80 mm diameter bundle of cables up to 80 mm diameter	4.0 mm thick by 210 mm long	90 mm Ø x 250 mm long	<b>E 90 EI 60</b>
Up to 100 mm diameter bundle of cables up to 21 mm diameter	4.5 mm thick by 210 mm long	110 mm Ø x 250 mm long	<b>EI 120</b>
Up to 100 mm diameter bundle of cables up to 50 mm diameter	4.5 mm thick by 210 mm long	110 mm Ø x 250 mm long	<b>E 120 EI 60</b>
Up to 100 mm diameter bundle of cables up to 80 mm diameter	4.5 mm thick by 210 mm long	110 mm Ø x 250 mm long	<b>E 90 EI 60</b>
Empty filled at mid-depth with 50 mm deep plug of Mineral Bio Wool	All inlay sizes specified above	All transit sizes specified above	<b>E 240 EI 180</b>
Up to 32mm diameter plastic pipes in bundle, empty or with penetrating bundle of cables up to 21 mm diameter			<b>E 120 C/U EI 60 C/U</b>
			<b>EI 120 C/U</b>



**A.7 Timber floor constructions with floor thickness of minimum 150 mm**

**A.7.1 Penetration seals in timber floors**

**Penetration Seal:** Cables fitted with minimum 250 mm long Protecta FR Service Transit central within the floor. The annular space around the Service Transit is sealed with Protecta FR Acrylic, minimum 25 mm deep to both sides of the floor backed with Stonewool (minimum 33kg/m<sup>3</sup> density), minimum 25 mm deep. Spaces around cables within the device are sealed with 50 mm deep Mineral Bio Wool installed centrally. Min. Separation between seals (a2) = 30 mm, min. Minimum separation between transit and supporting construction (a1) = 10 mm. Maximum aperture size is  $\varnothing$  220mm.

Construction details:

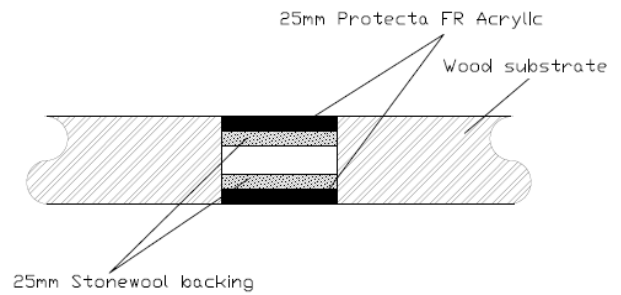
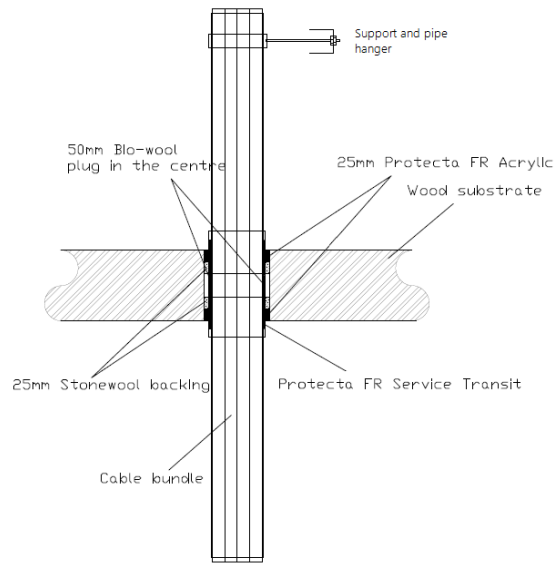

**Configuration 1**

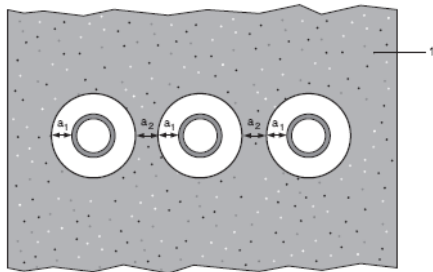

**Key**

- 1 Supporting construction
- a1 Pipe / edge of seal separation (annular space)
- a2 Separation between penetration seals

**A.7.1.1**

<b>Services</b>	<b>Inlay size</b>	<b>Transit size</b>	<b>Classification</b>
Up to 35 mm diameter bundle of cables up to 21 mm diameter	1.5 mm thick by 210 mm long	40 mm $\varnothing$ x 250 mm long	<b>EI 120</b>
Up to 35 mm diameter bundle of cables up to 35 mm diameter	1.5 mm thick by 210 mm long	40 mm $\varnothing$ x 250 mm long	<b>E 120</b> <b>EI 60</b>
Up to 50 mm diameter bundle of cables up to 21 mm diameter	2.0 mm thick by 210 mm long	63 mm $\varnothing$ x 250 mm long	<b>EI 120</b>
Up to 50 mm diameter bundle of cables up to 50 mm diameter	2.0 mm thick by 210 mm long	63 mm $\varnothing$ x 250 mm long	<b>E 120</b> <b>EI 60</b>
Up to 80 mm diameter bundle of cables up to 21 mm diameter	4.0 mm thick by 210 mm long	90 mm $\varnothing$ x 250 mm long	<b>EI 120</b>
Up to 80 mm diameter bundle of cables up to 50 mm diameter	4.0 mm thick by 210 mm long	90 mm $\varnothing$ x 250 mm long	<b>E 120</b> <b>EI 60</b>
Up to 80 mm diameter bundle of cables up to 80 mm diameter	4.0 mm thick by 210 mm long	90 mm $\varnothing$ x 250 mm long	<b>E 90</b> <b>EI 60</b>
Up to 100 mm diameter bundle of cables up to 21 mm diameter	4.5 mm thick by 210 mm long	110 mm $\varnothing$ x 250 mm long	<b>EI 120</b>
Up to 100 mm diameter bundle of cables up to 50 mm diameter	4.5 mm thick by 210 mm long	110 mm $\varnothing$ x 250 mm long	<b>E 120</b> <b>EI 60</b>
Up to 100 mm diameter bundle of cables up to 80 mm diameter	4.5 mm thick by 210 mm long	110 mm $\varnothing$ x 250 mm long	<b>E 90</b> <b>EI 60</b>
Empty filled at mid-depth with 50 mm deep plug of Mineral Bio Wool	All inlay sizes specified above	All transit sizes specified above	<b>EI 120</b>
Up to 32mm diameter plastic pipes in bundle, empty or with penetrating bundle of cables up to 21 mm diameter			<b>E 120 C/U</b> <b>EI 60 C/U</b>
			<b>EI 120 C/U</b>

## ANNEX B – Air Permeability – Protecta FR Service Transit

Product tested	110mm Protecta FR Service Transit with Bio wool seal no services		
	Summary of testing procedure		Result
	Pressure (Pa)	Leakage (m <sup>3</sup> /h)	Leakage (m <sup>3</sup> /m <sup>2</sup> /h)
Results under negative chamber pressure	25	0.18	N/A
	50	0.29	N/A
	100	0.46	N/A
	200	0.88	N/A
	300	1.33	N/A
	450	1.82	N/A
	600	2.66	N/A
Results under positive chamber pressure	25	0.08	N/A
	50	0.14	N/A
	100	0.35	N/A
	200	0.62	N/A
	300	1.44	N/A
	450	2.18	N/A
	600	3.24	N/A

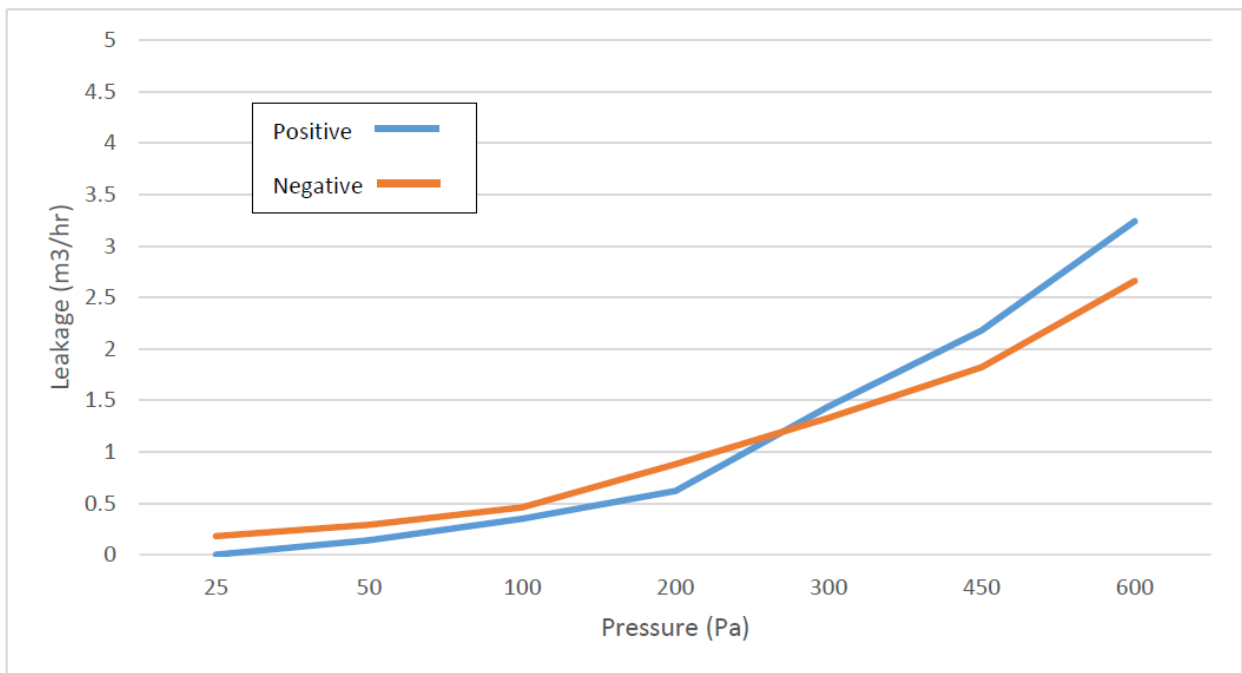

Product tested	110mm Protecta FR Service Transit with single 12mm cable through Bio wool seal		
	Summary of testing procedure		Result
	Pressure (Pa)	Leakage (m <sup>3</sup> /h)	Leakage (m <sup>3</sup> /m <sup>2</sup> /h)
Results under negative chamber pressure	25	0.14	N/A
	50	0.24	N/A
	100	0.4	N/A
	200	0.63	N/A
	300	1.4	N/A
	450	1.97	N/A
	600	2.72	N/A
Results under positive chamber pressure	25	0.05	N/A
	50	0.13	N/A
	100	0.36	N/A
	200	0.75	N/A
	300	1.5	N/A
	450	2.64	N/A
	600	3.6	N/A

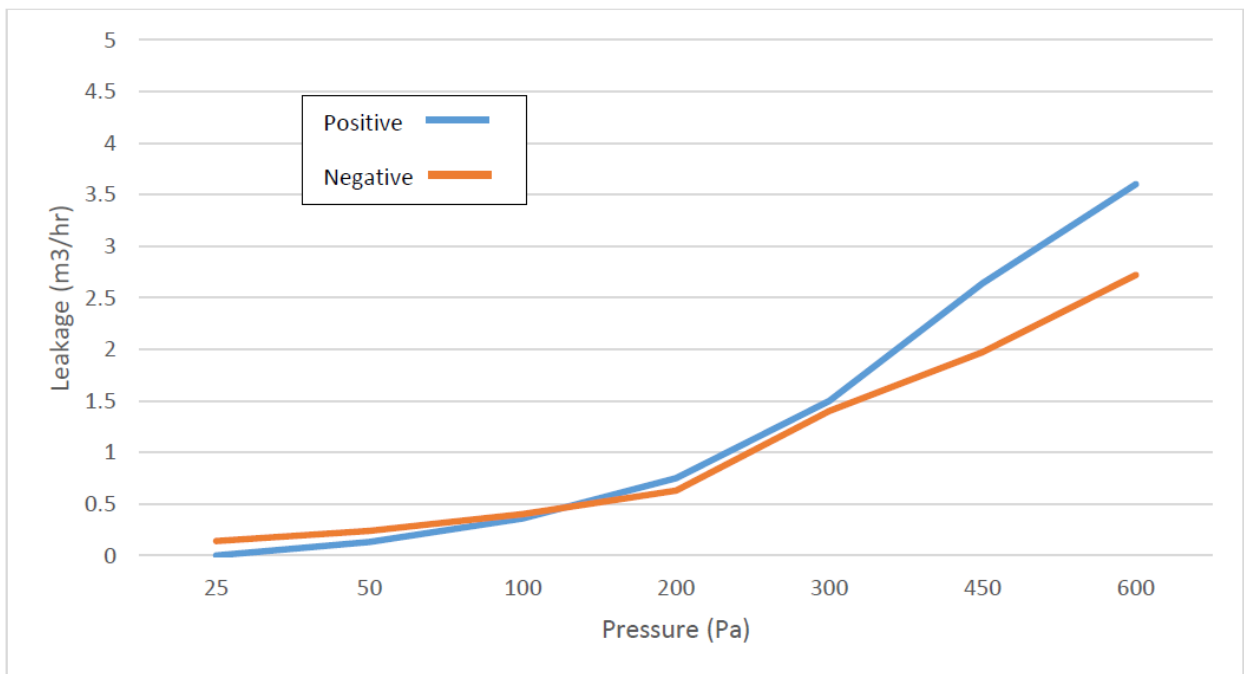

Product tested	110mm Protecta FR Service transit with 50mm bundle 12mm cables through Bio wool seal		
Summary of testing procedure			Result
	Pressure (Pa)	Leakage (m <sup>3</sup> /h)	Leakage (m <sup>3</sup> /m <sup>2</sup> /h)
Results under negative chamber pressure	25	0.35	N/A
	50	0.47	N/A
	100	0.72	N/A
	200	1.38	N/A
	300	2.52	N/A
	450	3.53	N/A
	600	4.27	N/A
Results under positive chamber pressure	25	0.14	N/A
	50	0.26	N/A
	100	0.66	N/A
	200	1.3	N/A
	300	2.46	N/A
	450	3.89	N/A
	600	4.8	N/A

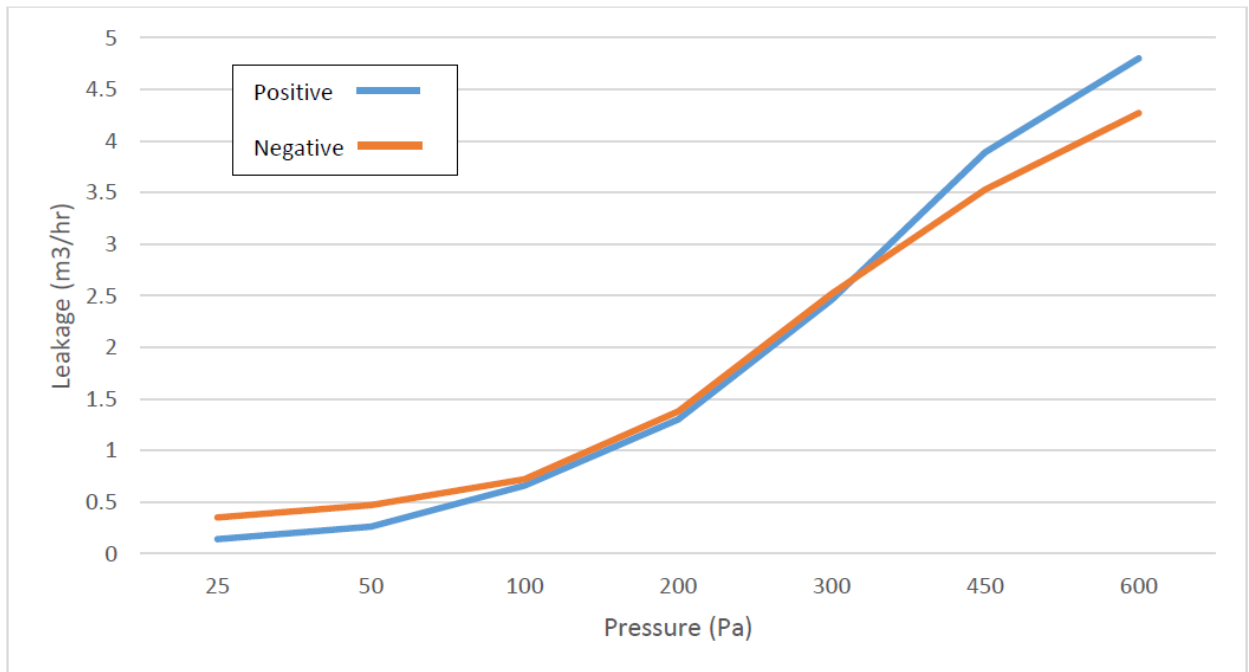

Product tested	110mm Protecta FR Service transit with 80mm bundle 12mm cables through Bio wool seal		
Summary of testing procedure			Result
	Pressure (Pa)	Leakage (m <sup>3</sup> /h)	Leakage (m <sup>3</sup> /m <sup>2</sup> /h)
Results under negative chamber pressure	25	1.43	N/A
	50	2.29	N/A
	100	3.84	N/A
	200	6.51	N/A
	300	9	N/A
	450	11.6	N/A
	600	14.15	N/A
Results under positive chamber pressure	25	1.43	N/A
	50	1.87	N/A
	100	3.59	N/A
	200	6.19	N/A
	300	8.63	N/A
	450	11.7	N/A
	600	14.43	N/A

