

Approval body for construction products
and types of construction

Bautechnisches Prüfamt

An institution established by the Federal and
Laender Governments



European Technical Assessment

ETA-16/0043
of 7 July 2021

English translation prepared by DIBt - Original version in German language

General Part

Technical Assessment Body issuing the
European Technical Assessment:

Deutsches Institut für Bautechnik

Trade name of the construction product

Würth concrete screw W-BS/S, W-BS/A4, W-BS/HCR

Product family
to which the construction product belongs

Mechanical fasteners for use in concrete

Manufacturer

Adolf Würth GmbH & Co. KG
Reinhold-Würth-Straße 12-17
74653 Künzelsau
DEUTSCHLAND

Manufacturing plant

Herstellwerk W9

This European Technical Assessment
contains

23 pages including 3 annexes which form an integral part
of this assessment

This European Technical Assessment is
issued in accordance with Regulation (EU)
No 305/2011, on the basis of

EAD 330232-00-0601, Edition 10/2016

This version replaces

ETA-16/0043 issued on 29 July 2019

The European Technical Assessment is issued by the Technical Assessment Body in its official language. Translations of this European Technical Assessment in other languages shall fully correspond to the original issued document and shall be identified as such.

Communication of this European Technical Assessment, including transmission by electronic means, shall be in full. However, partial reproduction may only be made with the written consent of the issuing Technical Assessment Body. Any partial reproduction shall be identified as such.

This European Technical Assessment may be withdrawn by the issuing Technical Assessment Body, in particular pursuant to information by the Commission in accordance with Article 25(3) of Regulation (EU) No 305/2011.

Specific Part

1 Technical description of the product

The Würth concrete screw W-BS is an anchor in size 6, 8, 10, 12 and 14 mm made of galvanised steel respectively steel with zinc flake coating, made of stainless or high corrosion resistant steel. The anchor is screwed into a predrilled cylindrical drill hole. The special thread of the anchor cuts an internal thread into the member while setting. The anchorage is characterised by mechanical interlock in the special thread.

Product and product description is given in Annex A.

2 Specification of the intended use in accordance with the applicable European Assessment Document

The performances given in Section 3 are only valid if the anchor is used in compliance with the specifications and conditions given in Annex B.

The verifications and assessment methods on which this European Technical Assessment is based lead to the assumption of a working life of the anchor of at least 50 years. The indications given on the working life cannot be interpreted as a guarantee given by the producer, but are to be regarded only as a means for choosing the right products in relation to the expected economically reasonable working life of the works.

3 Performance of the product and references to the methods used for its assessment

3.1 Mechanical resistance and stability (BWR 1)

Essential characteristic	Performance
Characteristic resistance to tension load (static and quasi-static loading)	See Annex C 1 and C 2
Characteristic resistance to shear load (static and quasi-static loading)	See Annex C 1 and C 2
Displacements (static and quasi-static loading)	See Annex C 7
Characteristic resistance and displacements for seismic performance categories C1 and C2	See Annex C 3, C 4, C 5 and C 8
Durability	See Annex B 1

3.2 Safety in case of fire (BWR 2)

Essential characteristic	Performance
Reaction to fire	Class A1
Resistance to fire	See Annex C 6

4 Assessment and verification of constancy of performance (AVCP) system applied, with reference to its legal base

In accordance with European Assessment Document EAD No. 330232-00-0601 the applicable European legal act is: [96/582/EC].

The system to be applied is: 1

5 Technical details necessary for the implementation of the AVCP system, as provided for in the applicable European Assessment Document

Technical details necessary for the implementation of the AVCP system are laid down in the control plan deposited at Deutsches Institut für Bautechnik.

Issued in Berlin on 7 July 2021 by Deutsches Institut für Bautechnik

Dipl.-Ing. Beatrix Wittstock
Head of Section

beglaubigt:
Tempel

Product in installed condition

Würth concrete screw W-BS

- Galvanized carbon steel
- Zinc flakes coated carbon steel

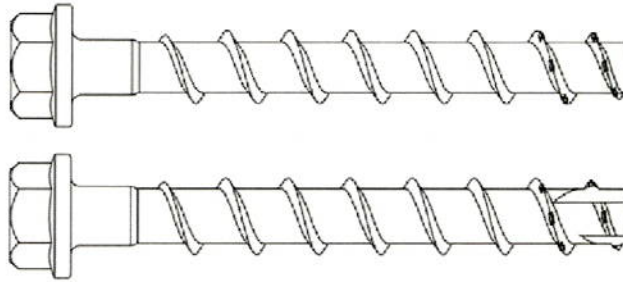

- Stainless steel A4
- Stainless steel HCR

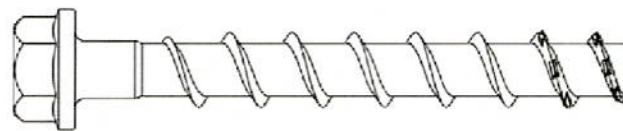

e.g. Würth concrete screw, zinc flakes coated, with hexagon head and fixture

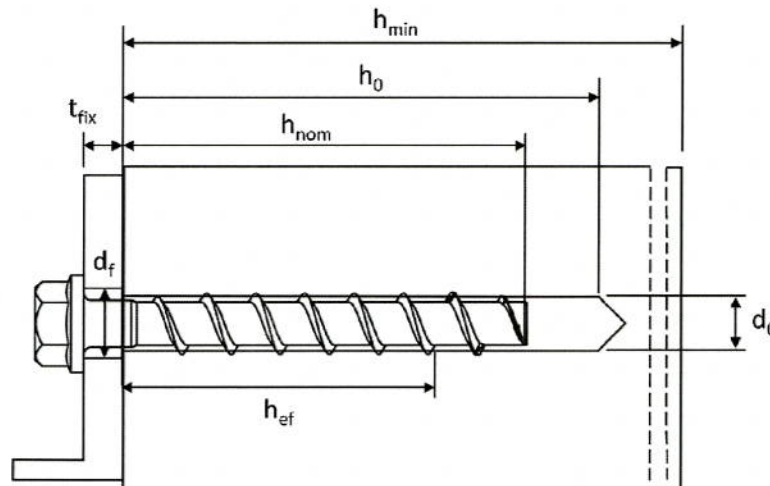

























d_0 = nominal drill hole diameter
 t_{fix} = thickness of fixture
 d_f = clearance hole diameter

h_{min} = minimum thickness of member
 h_{nom} = nominal embedment depth
 h_0 = drill hole depth
 h_{ef} = effective embedment depth

Würth concrete screw W-BS

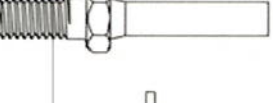
Product description
Product in installed condition

Annex A1

		Configuration with threaded stud and hexagon socket e.g. W-BS 8x105 Typ ST M10 WS5
		Configuration with threaded stud and hexagon drive e.g. W-BS 8x105 Typ ST M10 WS7
		Configuration with washer and hexagon head e.g. W-BS 8x80 Typ S WS13
		Configuration with washer, hexagon head and TX drive e.g. W-BS 8x80 Typ S WS13 und TX 40
		Configuration with washer and bund e.g. W-BS-T BND 14x130 WS24
		Configuration with hexagon head e.g. W-BS 8x80 Typ S WS
		Configuration with countersunk head and TX drive e.g. W-BS 8x80 Typ SK TX 40
		Configuration with pan head and TX drive e.g. W-BS 8x80 Typ P TX 40
		Configuration with large pan head and TX drive e.g. W-BS 8x80 Typ P TX 40
		Configuration with countersunk head and threaded stud e.g. TSM W-BS 6x55 Typ ST-6 M8
		Configuration with hexagon drive and threaded stud e.g. W-BS 6x55 Typ ST-6 M8 SW10
		Configuration with internal thread and hexagon drive e.g. W-BS 6x55 TYP I M8/10

Würth concrete screw W-BS	Annex A2
Product description Screw types	

English translation prepared by DIBt

Table 1: Material

Part	Product name	Material
all types	W-BS/S	- Steel EN 10263-4:2017 galvanized acc. to EN ISO 4042:2018 - Zinc flake coating according to EN ISO 10683:2018 ($\geq 5\mu\text{m}$) - Zinc flake coating according to EN ISO 10683:2018 Special coating TKC ($\geq 20\mu\text{m}$)
	W-BS/A4	1.4401; 1.4404; 1.4571; 1.4578
	W-BS/HCR	1.4529

Part	Product name	Nominal characteristic steel		Rupture elongation A_5 [%]
		Yield strength f_{yk} [N/mm ²]	Ultimate strength f_{uk} [N/mm ²]	
all types	W-BS/S	560	700	≤ 8
	W-BS/A4			
	W-BS/HCR			

Table 2: Dimensions

Anchor size		6		8			10			12			14		
Nominal embedment depth	h_{nom}	1	2	1	2	3	1	2	3	1	2	3	1	2	3
	[mm]	40	55	45	55	65	55	75	85	65	85	100	75	100	115
Screw length	$\leq L$	[mm] 500													
Core diameter	d_k	[mm] 5,1		7,1			9,1			11,1			13,1		
Thread outer diameter	d_s	[mm] 7,5		10,6			12,6			14,6			16,6		
Thickness of filling washer	t	[mm] -		5			5			5			5		

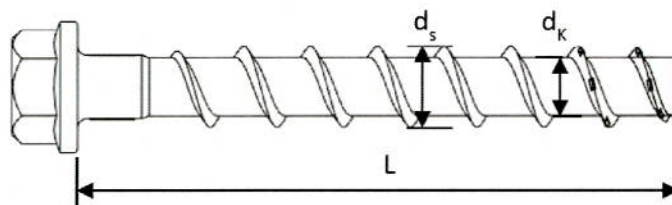

Würth concrete screw W-BS

Product description
Material, Dimensions and markings

Annex A3

English translation prepared by DIBt

..Marking

W-BS/S

Screw type: W-BS or TSM
Screw size: 10
Screw length: 100

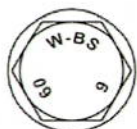

W-BS/A4

Screw type: W-BS or TSM
Screw size: 10
Screw length: 100
Material: A4

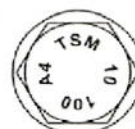

W-BS-T BND

Screw type: TSM BC ST
Screw size: 10
Screw length: 100



W-BS/HCR

Screw type: W-BS or TSM
Screw size: 10
Screw length: 100
Material: HCR

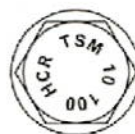

.Filling washer WIT-SHB

Filling washer WIT-SHB



Mixer reduction nozzle



Würth concrete screw W-BS

Product description
Material, Dimensions and markings

Annex A4

Specification of Intended use

Table 3: Anchorages subject to

W-BS concrete screw size	6		8			10			12			14		
Nominal embedment depth	h_{nom1}	h_{nom2}	h_{nom1}	h_{nom2}	h_{nom3}	h_{nom1}	h_{nom2}	h_{nom3}	h_{nom1}	h_{nom2}	h_{nom3}	h_{nom1}	h_{nom2}	h_{nom3}
	[mm]	40	55	45	55	65	55	75	85	65	85	100	65	85
Static and quasi-static loads	All sizes and all embedment depths													
Fire exposure	All sizes and all embedment depths													
C1 category - seismic	ok	ok				ok								
C2 category – seismic (A4 and HCR: no performance assessed)	- ¹⁾		- ¹⁾		ok	- ¹⁾	- ¹⁾	ok	- ¹⁾		ok	- ¹⁾		ok

¹⁾ no performance assessed

Base materials:

- Compacted reinforced and unreinforced concrete without fibers according to EN 206:2013.
- Strength classes C20/25 to C50/60 according to EN 206:2013.
- Cracked and uncracked concrete.

Use conditions (Environmental conditions):

- Concrete screws subject to dry internal conditions: all screw types.
- Structural subject to external atmospheric exposure (including industrial and marine environment) and to permanently damp internal condition no particular aggressive conditions exists: screw types made of stainless steel with marking A4.
- Structural subject to external atmospheric exposure (including industrial and marine environment) and to permanently damp internal condition if particular aggressive conditions exists: screw types made of stainless steel with marking HCR.

Note: Such particular aggressive conditions are e.g. permanent, alternating immersion in seawater or splash zone of seawater, chloride atmosphere of indoor swimming pools or atmosphere with chemical pollution (e.g. in desulphurization plants or road tunnels where de-icing materials are used).

Würth concrete screw W-BS

Intended use
Specification

Annex B1

Specification of Intended use - continuation

Design:

- Anchorages are to be designed under the responsibility of an engineer experienced in anchorages and concrete work.
- Verifiable calculation notes and drawings are to be prepared taking account of the loads to be anchored. The position of the anchor is indicated on the design drawings (e.g. position of the anchor relative to reinforcement or to supports, etc.).
- Anchorages are designed according to EN 1992-4:2018 and EOTA Technical Report TR 055. The design for shear load according to EN 1992-4:2018, Section 6.2.2 applies for all specified diameters d_f of clearance hole in the fixture in Annex B3, Table 4.

Installation:

- Hammer drilling or hollow drilling
- Anchor installation carried out by appropriately qualified personnel and under the supervision of the person responsible for technical matters on site.
- In case of aborted hole: new drilling must be drilled at a minimum distance of twice the depth of aborted hole or closer, if the aborted hole is filled with high strength mortar and only if the hole is not in the direction of the oblique tensile or shear load.
- After installation further turning of the anchor must not be possible. The head of the anchor is supported in the fixture and is not damaged.
- The borehole may be filled with injection mortar Würth concrete screw mortar WIT-BS
- Adjustability according to Annex B6 for sizes 6-14, all embedment depths, but not for seismic application
- Cleaning of borehole is not necessary, if using a hollow drill

Würth concrete screw W-BS	Annex B2
Intended use Specification continuation	

English translation prepared by DIBt

Table 4: Installation parameters

W-BS concrete screw size		6			8			10		
Nominal embedment depth	h_{nom}	h_{nom1}	h_{nom2}	h_{nom1}	h_{nom2}	h_{nom3}	h_{nom1}	h_{nom2}	h_{nom3}	
	[mm]	40	55	45	55	65	55	75	85	
Nominal drill hole diameter	d_0	6			8			10		
Cutting diameter of drill bit	$d_{cut} \leq$	6,40			8,45			10,45		
Drill hole depth	$h_0 \geq$	45	60	55	65	75	65	85	95	
Clearance hole diameter	$d_f \leq$	8			12			14		
Installation torque (version with connection thread)	T_{inst}	10			20			40		
Torque impact screw driver	[Nm]	Max. torque according to manufacturer's instructions								
		160			300			400		

W-BS concrete screw size		12			14		
Nominal embedment depth	h_{nom}	h_{nom1}	h_{nom2}	h_{nom3}	h_{nom1}	h_{nom2}	h_{nom3}
	[mm]	65	85	100	75	100	115
Nominal drill hole diameter	d_0	12			14		
Cutting diameter of drill bit	$d_{cut} \leq$	12,50			14,50		
Drill hole depth	$h_0 \geq$	75	95	110	85	110	125
Clearance hole diameter	$d_f \leq$	16			18		
Installation torque (version with connection thread)	T_{inst}	60			80		
Torque impact screw driver	$T_{imp,max}$	Max. torque according to manufacturer's instructions					
		650			650		

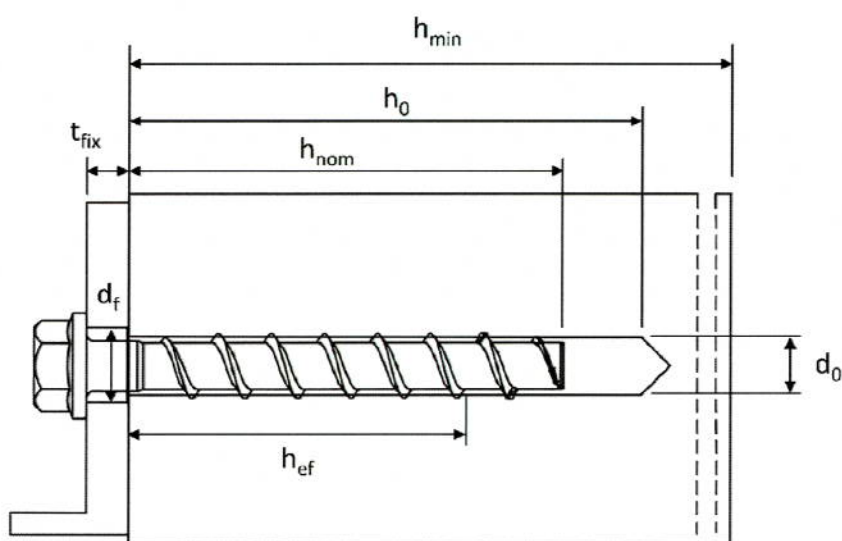

Würth concrete screw W-BS

Intended use
Installation parameters

Annex B3

Table 5: Minimum thickness of member, minimum edge distance and minimum spacing

W-BS concrete screw size		6			8			10		
Nominal embedment depth	h_{nom}	h_{nom1}	h_{nom2}	h_{nom1}	h_{nom2}	h_{nom3}	h_{nom1}	h_{nom2}	h_{nom3}	
	[mm]	40	55	45	55	65	55	75	85	
Minimum thickness of member	h_{min}	80						90	102	
Minimum edge distance	c_{min}	40	40	50	50					
Minimum spacing	s_{min}	40	40	50	50					

W-BS concrete screw size		12			14		
Nominal embedment depth	h_{nom}	h_{nom1}	h_{nom2}	h_{nom3}	h_{nom1}	h_{nom2}	h_{nom3}
	[mm]	65	85	100	75	100	115
Minimum thickness of member	h_{min}	80	101	120	87	119	138
Minimum edge distance	c_{min}	50	70	50	70		
Minimum spacing	s_{min}	50	70	50	70		

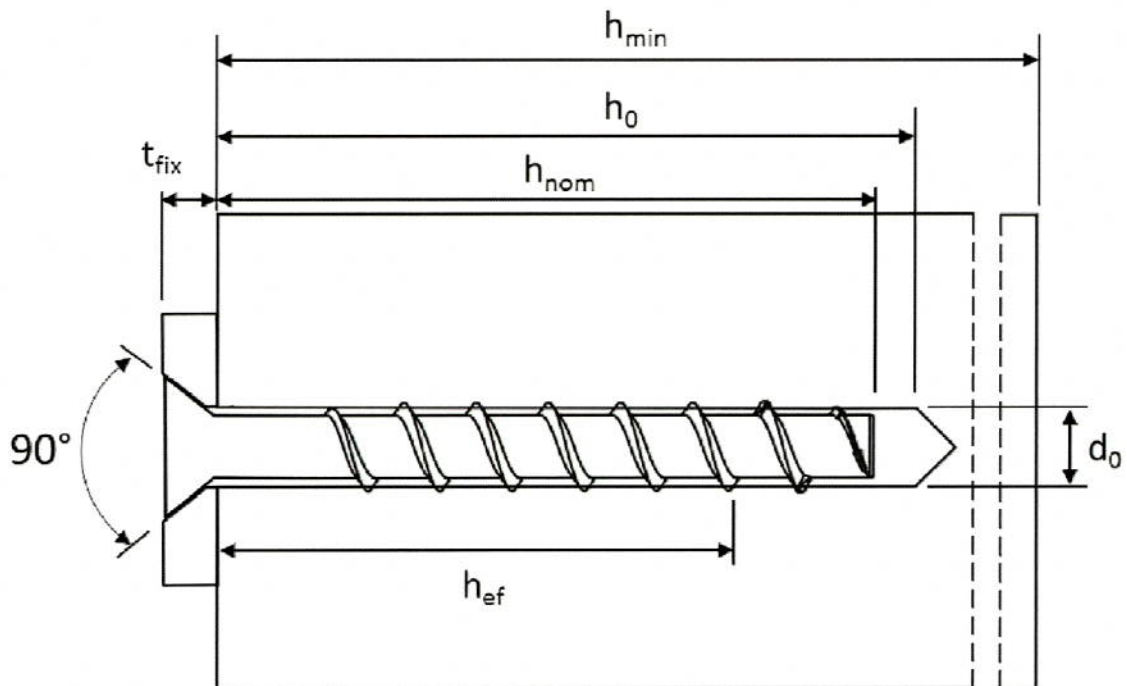

Würth concrete screw W-BS

Intended use

Minimum thickness of member, minimum edge distance and minimum spacing

Annex B4

Installation instructions

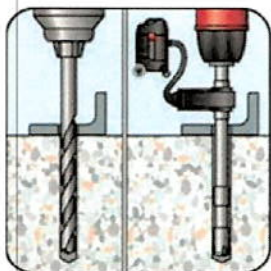

Create hammer drilled or hollow drilled borehole.

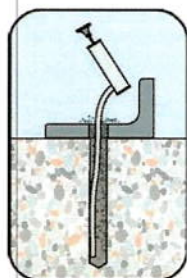

Clean the borehole. If using a hollow drill an additional cleaning of the borehole is not necessary.

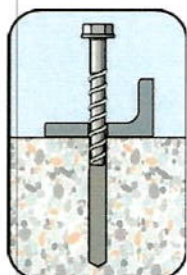

Set the screw

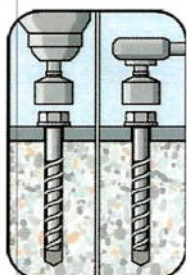

Install the screw by hand or using a impact screw driver. Consider $T_{imp,max}$ und T_{inst}

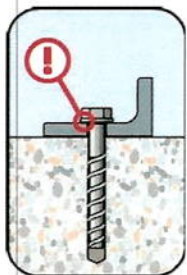

Installation was successful when the head of the anchor is fully supported and in contact to the fixture without damaging it.

Würth concrete screw W-BS

Intended use
Installation instructions

Annex B5

Installation instructions for adjustability for sizes 6 - 14

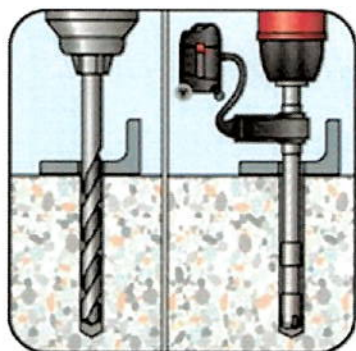

Create hammer drilled or hollow drilled borehole.

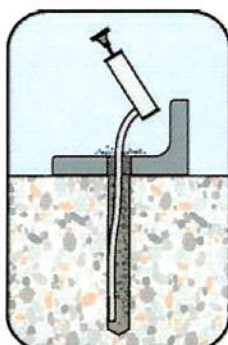

Clean the borehole. If using a hollow drill an additional cleaning of the borehole is not necessary.

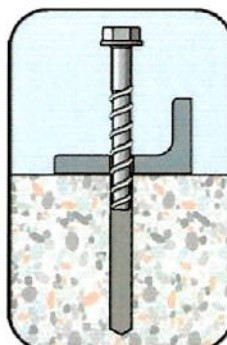

Set the screw

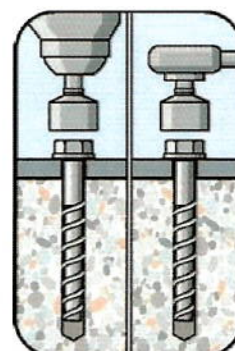

Install the screw by hand or using a impact screw driver. Consider $T_{imp,max}$ und T_{inst}

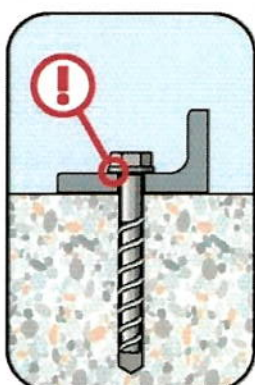

Installation was successful when the head of the anchor is fully supported and in contact to the fixture without damaging it.

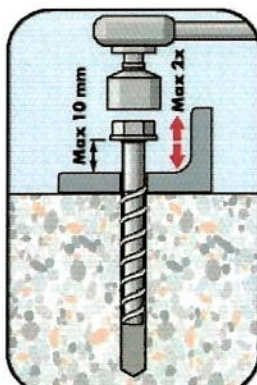

The Anchor may be adjusted max. two times while the anchor may turn back at most 10 mm.

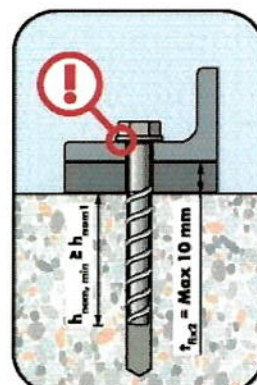

Install the screw again after the adjustment. The total allowed thickness of shims added during the adjustment process is 10 mm. The final embedment depth after adjustment process must be equal or larger than h_{nom} .

Note: Adjustment for seismic loading is not allowed

Würth concrete screw W-BS

Intended use
Installation instructions - Adjustment

Annex B6

Installation instruction – filling annular gap

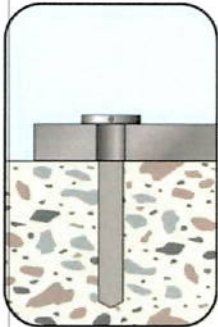
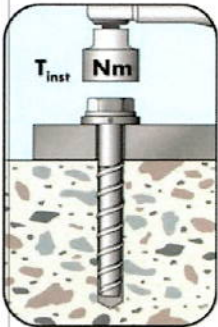
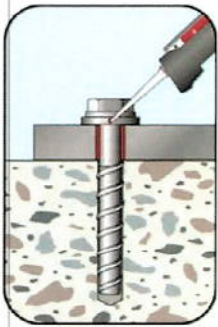
	<p>After preparing bore hole (Annex B5), position fixture first, than filling washer</p>
	<p>Install with impact screw driver or torque wrench. Consider $T_{imp,max}$ and T_{inst}</p>
	<p>Connect the mixer reduction nozzle to the tip of the mixer. Fill the annular gap with injection mortar. The annular gap is filled with mortar, when mortar oozes out of the washer.</p> <p>You can use Würth injection mortars with a compressive strength ≥ 40 N/mm² like CONCRETE MULTI WIT-UH 300, ALLROUNDER WIT-VM 250, WIT-PE 1000, or WIT-BS Observe the processing/installation instructions for the injection mortar.</p>

Notes:

1. For seismic loading the installation with filled and without filled annular gap is approved. Differences in performance can be found in Annex C5 – C7.
2. The thickness of fixture t_{fix} is reduced about 5 mm when using WÜRTH Filling Washer WIT-SHB.

Würth concrete screw W-BS

Intended use
Installation instructions - Filling annular gap

Annex B7

Table 6: Characteristic values for static and quasi-static loading, sizes 6-10

W-BS concrete screw size		6			8			10		
Nominal embedment depth	h_{nom}	h_{nom1}	h_{nom2}	h_{nom1}	h_{nom2}	h_{nom3}	h_{nom1}	h_{nom2}	h_{nom3}	
	[mm]	40	55	45	55	65	55	75	85	
Steel failure for tension and shear loading										
Characteristic tension load	$N_{RK,s}$ [kN]	14,0			27,0			45,0		
Partial factor	$\gamma_{Ms,N}$ [-]	1,5								
Characteristic shear load	$V_{RK,s}^0$ [kN]	7,0		13,5		17,0		22,5		34,0
Partial factor	$\gamma_{Ms,V}$ [-]	1,25								
Ductility factor	k_7 [-]	0,8								
Characteristic bending load	$M_{RK,s}^0$ [Nm]	10,9			26,0			56,0		
Pull-out failure										
Characteristic tension load C20/25	cracked	$N_{RK,p}$ [kN]	2,0	4,0	5,0	9,0	12,0	9,0	$\geq N_{RK,c}^0$ ¹⁾	
	uncracked	$N_{RK,p}$ [kN]	4,0	9,0	7,5	12,0	16,0	12,0	20,0	26,0
Increasing factor for $N_{RK,p}$	C25/30	ψ_c [-]		1,12						
	C30/37			1,22						
	C40/50			1,41						
	C50/60			1,58						
Concrete failure: Splitting failure, concrete cone failure and pry-out failure										
Effective embedment depth	h_{ef} [mm]	31	44	35	43	52	43	60	68	
k-factor	cracked	k_{cr} [-]	7,7							
	uncracked	k_{ucr} [-]	11,0							
Concrete cone failure	spacing	$s_{cr,N}$ [mm]	$3 \times h_{ef}$							
	edge distance	$c_{cr,N}$ [mm]	$1,5 \times h_{ef}$							
Splitting failure	resistance	$N_{RK,sp}^0$ [kN]	4,0	9,0	7,5	12,0	16,0	12,0	20,0	26,0
	spacing	$s_{cr,sp}$ [mm]	120	160	120	140	150	140	180	210
	edge distance	$c_{cr,sp}$ [mm]	60	80	60	70	75	70	90	105
Factor for pry-out failure	k_8 [-]	1,0							2,0	
Installation factor	γ_{inst} [-]	1,0								
Concrete edge failure										
Effective length in concrete	$l_f = h_{ef}$ [mm]	31	44	35	43	52	43	60	68	
Nominal outer diameter of screw	d_{nom} [mm]	6			8			10		

¹⁾ $N_{RK,c}^0$ according to EN 1992-4:2018

Würth concrete screw W-BS

Performances

Characteristic values for static and quasi-static loading, sizes 6-10

Annex C1

Table 7: Characteristic values for static and quasi-static loading, sizes 12-14

W-BS concrete screw size			12			14			
Nominal embedment depth	h_{nom}		h_{nom1}	h_{nom2}	h_{nom3}	h_{nom1}	h_{nom2}	h_{nom3}	
	[mm]		65	85	100	75	100	115	
Steel failure for tension and shear loading									
Characteristic tension load	$N_{RK,s}$	[kN]	67,0			94,0			
Partial factor	$\gamma_{Ms,N}$	[-]	1,5						
Characteristic shear load	$V^0_{RK,s}$	[kN]	33,5	42,0		56,0			
Partial factor	$\gamma_{Ms,V}$	[-]	1,25						
Ductility factor	k_7	[-]	0,8						
Characteristic bending load	$M^0_{RK,s}$	[Nm]	113,0			185,0			
Pull-out failure									
Characteristic tension load C20/25	cracked	$N_{RK,p}$	[kN]	12,0	$\geq N^0_{RK,c} \text{ } ^1)$				
	uncracked	$N_{RK,p}$	[kN]	16,0					
Increasing factor for $N_{RK,p}$	C25/30	ψ_c	[-]	1,12					
	C30/37			1,22					
	C40/50			1,41					
	C50/60			1,58					
Concrete failure: Splitting failure, concrete cone failure and pry-out failure									
Effective embedment depth	h_{ef}	[mm]	50	67	80	58	79	92	
k-factor	cracked	$k_1 = k_{cr}$	[-]	7,7					
	uncracked	$k_1 = k_{ucr}$	[-]	11,0					
Concrete cone failure	spacing	$s_{cr,N}$	[mm]	$3 \times h_{ef}$					
	edge distance	$c_{cr,N}$	[mm]	$1,5 \times h_{ef}$					
Splitting failure	resistance	$N^0_{RK,sp}$	[kN]	16,0	27,0	35,0	21,5	34,5	43,5
	spacing	$s_{cr,sp}$	[mm]	150	210	240	180	240	280
	edge distance	$c_{cr,sp}$	[mm]	75	105	120	90	120	140
Factor for pry-out failure	k_8	[-]	1,0	2,0		1,0	2,0		
Installation factor	γ_{inst}	[-]	1,0						
Concrete edge failure									
Effective length in concrete	$l_f = h_{ef}$	[mm]	50	67	80	58	79	92	
Nominal outer diameter of screw	d_{nom}	[mm]	12			14			

¹⁾ $N^0_{RK,c}$ according to EN 1992-4:2018

Würth concrete screw W-BS

Performances

Characteristic values for static and quasi-static loading, sizes 12-14

Annex C2

Table 8: Seismic category C1 – Characteristic load values (Typ S, Typ SK, Typ ST, Typ ST-6³⁾, Typ P and Typ I³⁾)

W-BS concrete screw size			6	8	10	12	14		
Nominal embedment depth	h_{nom}		h_{nom1}	h_{nom2}	h_{nom3}	h_{nom1}	h_{nom3}	h_{nom3}	
	[mm]		40	55	65	55	85	100	115
Steel failure for tension and shear load (configuration Typ S, Typ SK, Typ ST, Typ ST-6³⁾, Typ P and Typ I³⁾)									
Characteristic load	$N_{Rk,s,eq}$	[kN]	14,0	27,0	45,0	67,0	94,0		
Partial factor	$\gamma_{Ms,eq}$	[-]	1,5						
Characteristic load	$V_{Rk,s,eq}$	[kN]	4,7	5,5	8,5	13,5	15,3	21,0	22,4
Partial factor	$\gamma_{Ms,eq}$	[-]	1,25						
With filling of the annular gap ¹⁾	α_{gap}	[-]	1,0						
Without filling of the annular gap	α_{gap}	[-]	0,5						
Pull-out failure									
Characteristic tension load in cracked concrete C20/25	$N_{Rk,p,eq}$	[kN]	2,0	4,0	12,0	9,0	$\geq N^0_{Rk,c}$ ²⁾		
Concrete cone failure									
Effective embedment depth	h_{ef}	[mm]	31	44	52	43	68	80	92
Edge distance	$c_{cr,N}$	[mm]	$1,5 \times h_{ef}$						
Spacing	$s_{cr,N}$	[mm]	$3 \times h_{ef}$						
Installation safety factor	γ_{inst}	[-]	1,0						
Concrete pry-out failure									
Factor for pry-out failure	k_8	[-]	1,0			2,0			
Concrete edge failure									
Effective length in concrete	$l_f = h_{ef}$	[mm]	31	44	52	43	68	80	92
Nominal outer diameter of screw	d_{nom}	[mm]	6	6	8	10	10	12	14

¹⁾ Filling of the annular gap according to annex B7, figure 5

²⁾ $N^0_{Rk,c}$ according to EN 1992-4:2018

³⁾ just for tension load

Würth concrete screw W-BS

Performances
Seismic category C1 – Characteristic load values

Annex C3

Table 9: Seismic category C2 ¹⁾ – Characteristic load values with filled annular gap according to annex B7, figure 5 (Typ S, Typ ST, Typ P)

W-BS concrete screw size			8	10	12	14
Nominal embedment depth	h_{nom}	h_{nom3}				
	[mm]	65	85	100	115	
Steel failure for tension and shear load (configuration Typ S, Typ ST und Typ P)						
Characteristic load	$N_{Rk,s,eq}$	[kN]	27,0	45,0	67,0	94,0
Partial factor	$\gamma_{Ms,eq}$	[-]	1,5			
Characteristic load	$V_{Rk,s,eq}$	[kN]	9,9	18,5	31,6	40,7
Partial factor	$\gamma_{Ms,eq}$	[-]	1,25			
With filling of the annular gap	α_{gap}	[-]	1,0			
Pull-out failure						
Characteristic load in cracked concrete	$N_{Rk,p,eq}$	[kN]	2,4	5,4	7,1	10,5
Concrete cone failure						
Effective embedment depth	h_{ef}	[mm]	52	68	80	92
Edge distance	$c_{cr,N}$	[mm]	$1,5 \times h_{ef}$			
Spacing	$s_{cr,N}$	[mm]	$3 \times h_{ef}$			
Installation safety factor	γ_{inst}	[-]	1,0			
Concrete pry-out failure						
Factor for pry-out failure	k_8	[-]	1,0	2,0		
Concrete edge failure						
Effective length in concrete	$l_f = h_{ef}$	[mm]	52	68	80	92
Nominal outer diameter of screw	d_{nom}	[mm]	8	10	12	14

¹⁾ A4 and HCR not suitable

Würth concrete screw W-BS

Performances

Seismic category C2 – Characteristic load values with filled annular gap

Annex C4

Table 10: Seismic category C2 ¹⁾ – Characteristic load values **without filled annular gap according to annex B7, figure 3** (Typ S, Typ SK, Typ ST, Typ P)

W-BS concrete screw size			8	10	12	14
Nominal embedment depth	h_{nom}		h_{nom3}			
	[mm]		65	85	100	115
Steel failure for tension and shear load (configuration Typ S, Typ ST und Typ P)						
Characteristic load	$N_{Rk,s,eq}$	[kN]	27,0	45,0	67,0	94,0
Partial factor	$\gamma_{Ms,eq}$	[-]	1,5			
Characteristic load	$V_{Rk,s,eq}$	[kN]	10,3	21,9	24,4	23,3
Partial factor	$\gamma_{Ms,eq}$	[-]	1,25			
Without filling of the annular gap	α_{gap}	[-]	0,5			
Pull-out failure (configuration Typ S, Typ ST und Typ P)						
Characteristic load in cracked concrete	$N_{Rk,p,eq}$	[kN]	2,4	5,4	7,1	10,5
Steel failure for tension and shear load (configuration Typ SK)						
Characteristic load	$N_{Rk,s,eq}$	[kN]	27,0	45,0	no performance assessed	
Partial factor	$\gamma_{Ms,eq}$	[-]	1,5			
Characteristic load	$V_{Rk,s,eq}$	[kN]	3,6	13,7		
Partial factor	$\gamma_{Ms,eq}$	[-]	1,25			
Without filling of the annular gap	α_{gap}	[-]	0,5			
Pull-out failure (configuration Typ SK)						
Characteristic load in cracked concrete	$N_{Rk,p,eq}$	[kN]	2,4	5,4	no performance assessed	
Concrete cone failure						
Effective embedment depth	h_{ef}	[mm]	52	68	80	92
Edge distance	$c_{cr,N}$	[mm]	$1,5 \times h_{ef}$			
Spacing	$s_{cr,N}$	[mm]	$3 \times h_{ef}$			
Installation safety factor	γ_{inst}	[-]	1,0			
Concrete pry-out failure						
Factor for pry-out failure	k_8	[-]	1,0	2,0		
Concrete edge failure						
Effective length in concrete	$l_f = h_{ef}$	[mm]	52	68	80	92
Nominal outer diameter of screw	d_{nom}	[mm]	8	10	12	14

¹⁾ A4 and HCR not suitable

Würth concrete screw W-BS

Performances

Seismic category C2 – Characteristic load values without filled annular gap

Annex C5

Table 11: Fire exposure – characteristic values of resistance

W-BS concrete screw size				6		8			10			12			14				
Nominal embedment depth	h_{nom} [mm]	1		2		3		1		2		3		1		2		3	
		40	55	45	55	65	55	75	85	65	85	100	75	100	115				
Steel failure for tension and shear load																			
characteristic Resistance	R30	$N_{Rk,s,fi30}$	[kN]	0,9		2,4			4,4			7,3			10,3				
	R60	$N_{Rk,s,fi60}$	[kN]	0,8		1,7			3,3			5,8			8,2				
	R90	$N_{Rk,s,fi90}$	[kN]	0,6		1,1			2,3			4,2			5,9				
	R120	$N_{Rk,s,fi120}$	[kN]	0,4		0,7			1,7			3,4			4,8				
	R30	$V_{Rk,s,fi30}$	[kN]	0,9		2,4			4,4			7,3			10,3				
	R60	$V_{Rk,s,fi60}$	[kN]	0,8		1,7			3,3			5,8			8,2				
	R90	$V_{Rk,s,fi90}$	[kN]	0,6		1,1			2,3			4,2			5,9				
	R120	$V_{Rk,s,fi120}$	[kN]	0,4		0,7			1,7			3,4			4,8				
	R30	$M^0_{Rk,s,fi30}$	[Nm]	0,7		2,4			5,9			12,3			20,4				
	R60	$M^0_{Rk,s,fi60}$	[Nm]	0,6		1,8			4,5			9,7			15,9				
	R90	$M^0_{Rk,s,fi90}$	[Nm]	0,5		1,2			3,0			7,0			11,6				
	R120	$M^0_{Rk,s,fi120}$	[Nm]	0,3		0,9			2,3			5,7			9,4				

Pull-out failure

Characteristic Resistance	R30- R90	$N_{Rk,p,fi}$	[kN]	0,5	1,0	1,3	2,3	3,0	2,3	4,0	4,8	3,0	4,7	6,2	3,8	6,0	7,6
	R120	$N_{Rk,p,fi}$	[kN]	0,4	0,8	1,0	1,8	2,4	1,8	3,2	3,9	2,4	3,8	4,9	3,0	4,8	6,1

Concrete cone failure

Characteristic Resistance	R30- R90	$N^0_{Rk,c,fi}$	[kN]	0,9	2,2	1,2	2,1	3,4	2,1	4,8	6,6	3,0	6,3	9,9	4,4	9,6	14,0
	R120	$N^0_{Rk,c,fi}$	[kN]	0,7	1,8	1,0	1,7	2,7	1,7	3,8	5,3	2,4	5,1	7,9	3,5	7,6	11,2

Edge distance

R30 bis R120	$c_{cr,fi}$	[mm]	2 x h_{ef}														
--------------	-------------	------	--------------	--	--	--	--	--	--	--	--	--	--	--	--	--	--

In case of fire attack from more than one side, the minimum edge distance shall be ≥ 300 mm.

Spacing

R30 bis R120	$s_{cr,fi}$	[mm]	4 x h_{ef}														
--------------	-------------	------	--------------	--	--	--	--	--	--	--	--	--	--	--	--	--	--

Pry-out failure

R30 bis R120	k_8	[-]	1,0			2,0		1,0		2,0		1,0		2,0	
--------------	-------	-----	-----	--	--	-----	--	-----	--	-----	--	-----	--	-----	--

The anchorage depth has to be increased for wet concrete by at least 30 mm compared to the given value.

Würth concrete screw W-BS

Performances
Fire exposure – characteristic values of resistance

Annex C6

English translation prepared by DIBt

Table 12: Displacements under static and quasi-static tension load

W-BS concrete screw size				6			8			10		
Nominal embedment depth				h_{nom}	h_{nom1}	h_{nom2}	h_{nom1}	h_{nom2}	h_{nom3}	h_{nom1}	h_{nom2}	h_{nom3}
				[mm]	40	55	45	55	65	55	75	85
Cracked concrete	tension load	N	[kN]	0,95	1,9	2,4	4,3	5,7	4,3	7,9	9,6	
	displacement	δ_{N0}	[mm]	0,3	0,6	0,6	0,7	0,8	0,6	0,5	0,9	
		$\delta_{N\infty}$	[mm]	0,4	0,4	0,6	1,0	0,9	0,4	1,2	1,2	
Uncracked concrete	tension load	N	[kN]	1,9	4,3	3,6	5,7	7,6	5,7	9,5	11,9	
	displacement	δ_{N0}	[mm]	0,4	0,6	0,7	0,9	0,5	0,7	1,1	1,0	
		$\delta_{N\infty}$	[mm]	0,4	0,4	0,6	1,0	0,9	0,4	1,2	1,2	

W-BS concrete screw size				12			14			
Nominal embedment depth				h_{nom}	h_{nom1}	h_{nom2}	h_{nom3}	h_{nom1}	h_{nom2}	h_{nom3}
				[mm]	65	85	100	75	100	115
Cracked concrete	tension load	N	[kN]	5,7	9,4	12,3	7,6	12,0	15,1	
	displacement	δ_{N0}	[mm]	0,9	0,5	1,0	0,5	0,8	0,7	
		$\delta_{N\infty}$	[mm]	1,0	1,2	1,2	0,9	1,2	1,0	
Uncracked concrete	tension load	N	[kN]	7,6	13,2	17,2	10,6	16,9	21,2	
	displacement	δ_{N0}	[mm]	1,0	1,1	1,2	0,9	1,2	0,8	
		$\delta_{N\infty}$	[mm]	1,0	1,2	1,2	0,9	1,2	1,0	

Table 13: Displacements under static and quasi-static shear load

W-BS concrete screw size				6			8			10		
Nominal embedment depth				h_{nom}	h_{nom1}	h_{nom2}	h_{nom1}	h_{nom2}	h_{nom3}	h_{nom1}	h_{nom2}	h_{nom3}
				[mm]	40	55	45	55	65	55	75	85
Cracked and uncracked concrete	shear load	V	[kN]	3,3			8,6			16,2		
	displacement	δ_{V0}	[mm]	1,55			2,7			2,7		
		$\delta_{V\infty}$	[mm]	3,1			4,1			4,3		

W-BS concrete screw size				12			14			
Nominal embedment depth				h_{nom}	h_{nom1}	h_{nom2}	h_{nom3}	h_{nom1}	h_{nom2}	h_{nom3}
				[mm]	65	85	100	75	100	115
Cracked and uncracked concrete	shear load	V	[kN]	20,0			30,5			
	displacement	δ_{V0}	[mm]	4,0			3,1			
		$\delta_{V\infty}$	[mm]	6,0			4,7			

Würth concrete screw W-BS

Performances
Displacements under static and quasi-static loads

Annex C7

Table 14: Seismic category C2 ¹⁾ – Displacements **with filled annular gap** according to annex B7, figure 5 (Typ S, Typ ST, Typ P)

W-BS concrete screw size		8	10	12	14
Nominal embedment depth	h_{nom}	h_{nom3}			
	[mm]	65	85	100	115

Displacements under tension loads (configuration Typ S, Typ ST, Typ P)						
Displacement DLS	$\bar{\delta}_{N,eq(DLS)}$	[mm]	0,66	0,32	0,57	1,16
Displacement ULS	$\bar{\delta}_{N,eq(ULS)}$	[mm]	1,74	1,36	2,36	4,39

Displacements under shear loads (configuration Typ S, Typ ST, Typ P, with hole clearance)						
Displacement DLS	$\bar{\delta}_{V,eq(DLS)}$	[mm]	1,68	2,91	1,88	2,42
Displacement ULS	$\bar{\delta}_{V,eq(ULS)}$	[mm]	5,19	6,72	5,37	9,27

Table 15: Seismic category C2 ¹⁾ – Displacements **without filled annular gap** according to annex B7, figure 3 (Typ S, Typ SK, Typ ST, Typ P)

W-BS concrete screw size		8	10	12	14
Nominal embedment depth	h_{nom}	h_{nom3}			
	[mm]	65	85	100	115

Displacements under tension loads (configuration Typ S, Typ ST, Typ P)						
Displacement DLS	$\bar{\delta}_{N,eq(DLS)}$	[mm]	0,66	0,32	0,57	1,16
Displacement ULS	$\bar{\delta}_{N,eq(ULS)}$	[mm]	1,74	1,36	2,36	4,39

Displacements under tension loads (configuration Typ SK)						
Displacement DLS	$\bar{\delta}_{N,eq(DLS)}$	[mm]	0,66	0,32	no performance assessed	
Displacement ULS	$\bar{\delta}_{N,eq(ULS)}$	[mm]	1,74	1,36		

Displacements under shear loads (configuration Typ S, Typ ST, Typ P, with hole clearance)						
Displacement DLS	$\bar{\delta}_{V,eq(DLS)}$	[mm]	4,21	4,71	4,42	5,60
Displacement ULS	$\bar{\delta}_{V,eq(ULS)}$	[mm]	7,13	8,83	6,95	12,63

Displacements under shear loads (configuration Typ SK with hole clearance)						
Displacement DLS	$\bar{\delta}_{V,eq(DLS)}$	[mm]	2,51	2,98	no performance assessed	
Displacement ULS	$\bar{\delta}_{V,eq(ULS)}$	[mm]	7,76	6,25		

¹⁾ A4 and HCR not suitable

Würth concrete screw W-BS

Performances
Displacements under seismic loads

Annex C8