



UL International (Netherlands) B.V.
Westervoortsedijk 60,
6827AT Arnhem,
The Netherlands



designated according to Article 29 of the Regulation (EU) No 305/2011 and member of EOTA (European Organisation for Technical Assessment, www.eota.eu)

European Technical Assessment

ETA 22/0032 of 30/03/2022

Technical Assessment Body issuing the ETA and designated according to Article 29 of the Regulation (EU) No 305/2011: **UL International (Netherlands) B.V.**

Trade name of the construction product	Protecta FR Putty
Product family to which the construction product belongs	Fire Stopping and Sealing Product: • Penetration Seals
Manufacturer	Polyseam Ltd 15. St. Andrews Road Huddersfield, West Yorkshire HD1 6SB, UK www.protecta.co.uk
Manufacturing plant(s)	Polyseam Ltd 15. St. Andrews Road Huddersfield, West Yorkshire HD1 6SB, UK
This European Technical Assessment contains	42 pages including 1 Annex which forms an integral part of this assessment.
This European Technical Assessment is issued in accordance with regulation (EU) No 305/2011, on the basis of	EAD 350454-00-1104, September 2017.
Corrigendum No. 1	

Translations of this European Technical Assessment in other languages shall fully correspond to the original issued document and should be identified as such.

Communication of this European Technical Assessment, including transmission by electronic means, shall be in full. However, partial reproduction may be made, with the written consent of the issuing Technical Assessment Body. Any partial reproduction has to be identified as such.

Table of Contents

I.SPECIFIC PARTS OF THE EUROPEAN TECHNICAL ASSESSMENT	3
1 Technical description of the product	3
2 Specification of the intended uses of the product in accordance with the applicable European Assessment Document (Hereinafter EAD): EAD 350454-00-1104.....	3
3 Performance of the product and references to the methods used for its assessment	5
4 Technical details necessary for the implementation of the AVCP system, as provided for in the applicable EAD	6
5 Issued on:.....	7
ANNEX A – Resistance to Fire Classification – Protecta FR Putty	8
A.1 Flexible wall constructions with wall thickness of minimum 100 mm	8
A.1.1 Pipe and cable penetration seals with 4 mm thick Protecta FR Putty in plastic socket box	8
A.1.2 Cable penetration seals with 4 mm thick Protecta FR Putty in plastic socket box	9
A.1.2.1 Double sided penetration seal with cables in socket boxes	9
A.1.3 Cable penetration seals with 4 mm thick Protecta FR Putty in metallic socket box	10
A.1.3.1 Double sided penetration seal with cables in socket boxes	10
A.1.4 Double sided penetration seal with cables	11
A.1.5 Double sided penetration seal with pipes.....	12
A.1.6 Double sided penetration seal with insulated metallic pipes, Local Interrupted (LI)	15
A.1.7 Double sided penetration seal with insulated metallic pipes, Continuous Sustained (CS)	17
A.2 Flexible wall constructions with wall thickness of minimum 120 mm	20
A.2.1 Cable penetration seals with 4 mm thick Protecta FR Putty in plastic socket box	20
A.2.2 Double sided penetration seal with metallic pipes	21
A.3 Rigid wall constructions with wall thickness of minimum 150 mm.....	22
A.3.1 Double sided penetration seal with insulated metallic pipes, Continuous Sustained (CS)	22
A.4 Rigid floor constructions with floor thickness of minimum 150 mm	24
A.4.1 Single sided penetration seal with cables	24
A.4.2 Single sided penetration seal with cables	25
A.4.3 Double sided penetration seal with cables	26
A.4.4 Single sided penetration seal with metallic pipes	27
A.4.5 Single sided penetration seal with metallic pipes	29
A.4.6 Double sided penetration seal with metallic pipes	32
A.4.7 Single sided penetration seal with insulated metallic pipes, Local Interrupted (LI)	33
A.4.8 Single sided penetration seal with insulated metallic pipes, Local Interrupted (LI)	35
A.4.9 Single sided penetration seal with insulated metallic pipes, Continuous Sustained (CS)	37
A.4.10 Single sided penetration seal with insulated metallic pipes, Continuous Sustained (CS)	40
ANNEX B – Air Permeability – Protecta FR Putty.....	42

I. SPECIFIC PARTS OF THE EUROPEAN TECHNICAL ASSESSMENT

1 Technical description of the product

- 1) Protecta FR Putty is a flexible pad or cord used to reinstate the fire resistance performance of wall and floor constructions where they have been provided with apertures for the penetration of insulated or uninsulated metallic pipes, cables, and pipes or cables into socket boxes.
- 2) The Protecta FR Putty is supplied precut to size with a peel off strip to both faces to prevent it from bonding materials other than for the desired application. The Protecta FR Putty is installed by removing the peelable strips and wrapping the pad around the socket box where it penetrates the face of the wall and covering the back face of the box. When installing around service penetrations, the Protecta FR Putty is installed by removing the peelable strips and wrapping the cord around the service where it penetrates the face of the wall or floor.
- 3) Polyseam Ltd has submitted a written declaration that Protecta FR Putty does not contain substances which have to be classified as dangerous according to Directive 67/548/EEC and Regulation (EC) No 1272/2008 and listed in the "Indicative list on dangerous substances" of the EGDS - taking into account the installation conditions of the construction product and the release scenarios resulting from there.

In addition to the specific clauses relating to dangerous substances contained in this European technical Assessment, there may be other requirements applicable to the products falling within its scope (e.g., transposed European legislation and national laws, regulations and administrative provisions). In order to meet the provisions of the Construction Products Regulation, these requirements need also to be complied with, when and where they apply.

- 4) The use category of Protecta FR Putty in relation to BWR 3 (Hygiene, health and environment) is IA1.

2 Specification of the intended uses of the product in accordance with the applicable European Assessment Document (Hereinafter EAD): EAD 350454-00-1104

Detailed information and data is given in Annex A.

- 1) The intended use of Protecta FR Putty is to reinstate the fire resistance performance of flexible, masonry or concrete walls and rigid floor constructions where they are penetrated by insulated or uninsulated metallic pipes, cables and the pipe or cable protrusion of socket boxes.
- 2) The specific elements of construction that the system Protecta FR Putty may be used to provide a penetration seal in, are as follows:
 - a. Flexible walls: The wall must have a minimum thickness of 100 mm and comprise steel studs or timber studs* lined on both faces with minimum 2 layers of 12.5 mm thick boards.
 - b. Rigid walls: The wall must have a minimum thickness of 100 mm and comprise concrete, aerated concrete or masonry with a minimum density of 650 kg/m³.
 - c. Rigid floors: The floor must have a minimum thickness of 150 mm and comprise aerated concrete or concrete with a minimum density of 650 kg/m³.

* no part of the penetration seal may be closer than 100 mm to a stud, the cavity must be closed between the penetration seal and the stud, and minimum 100 mm of insulation of class A1 or A2 according to EN 13501-1 must be provided within the cavity between the penetration seal and the stud.

The supporting construction must be classified in accordance with EN 13501-2 for the required fire resistance period.

Protecta Fire Protection Systems which involve seals on both sides of a flexible wall may also be used in the situation where the linear seal is on one side of the wall only and the remaining side of the wall is not punctured at the same point. All fire integrity and thermal insulation ratings for such single-sided seals remain the same as for the equivalent double-sided seal.

- 3) The System Protecta FR Putty may be used to provide a penetration seal for insulated or uninsulated metallic pipes, cables and the pipe or cable protrusion of socket boxes (for details see Annex A).
- 4) The system Protecta FR Putty may be used to seal gaps between 0 mm and 10 mm surrounding cables, cable bundles, non-insulated and insulated pipes, and 137 mm wide by 77 mm high (aperture containing socket box) and be installed in accordance with the manufacturer's instructions. When used with socket boxes, the aperture in the wall shall be as tight as possible to the penetration pipe or cable and any gaps filled with plaster filler or Protecta FR Acrylic.
- 5) Where single sided top face seals are described in Annex A, these can also be used in composite floors (e.g., Concrete filled, steel trapezoidal decking).
- 6) Services shall be supported at maximum 300 mm away from both faces of the wall constructions, and 500 mm from the upper face of floor constructions.
- 7) The designation U/U, C/U, U/C or C/C indicates whether or not the product under test is sealed during the fire test.

The first letter refers to the situation in the oven and the second to the situation outside the oven (see table).

Test Condition	Configuration	
	Exposed to heat from oven (inside the oven)	Unexposed to heat from oven (outside the oven)
U/U	Unsealed	Unsealed
C/U	Sealed	Unsealed
U/C	Unsealed	Sealed
C/C	Sealed	Sealed

- a. The tests carried out with unsealed ends (U/U) correspond to the most unfavorable situation, since the fire can spread more easily because the two ends are unsealed. The results of these tests may therefore be applied in all situations (U/U, C/U, U/C and C/C).
 - b. The C/U tests may be used in the following situations: C/U, U/C and C/C.
 - c. The U/C tests may in turn be used for situations U/C and C/C, while the C/C tests may only be used in the C/C situation.
- 8) The provisions made in this European Technical Assessment are based on an assumed working life of the Protecta FR Putty of 25 years, provided that the conditions laid down in the product datasheet for the packaging/transport/ storage/installation/use/repair are met. The indications given on the working life cannot be interpreted as a guarantee given by the producer, but are to be regarded only as a means for choosing the right products in relation to the expected economically reasonable working life of the works.
 - 9) Type Z₂: Intended for uses in internal conditions with humidity lower than 85 % RH excluding temperatures below 0°C, without exposure to rain or UV.

3 Performance of the product and references to the methods used for its assessment

Product-type: Intumescent sheet		Intended use: Penetration Seal
Assessment method	Essential characteristic	Product performance
BWR 2 Safety in case of fire		
EN 13501-1	Reaction to fire	No performance determined
EN 13501-2	Resistance to fire	Annex A
BWR 3 Hygiene, health and environment		
EN 1026	Air permeability	Annex B
EAD 350454-00-1104, Annex C	Water permeability	No performance determined
Declaration of manufacturer & EN 16516	Content, emission and/or release of dangerous substances	Use categories: IA1 Declaration of manufacturer
BWR 4 Safety in use		
EOTA TR 001:2003	Mechanical resistance and stability	No performance determined
EOTA TR 001:2003	Resistance to impact/movement	No performance determined
EOTA TR 001:2003	Adhesion	No performance determined
EAD 350454-00-1104, Clause 2.2.9	Durability	Z ₂
BWR 5 Protection against noise		
EN 10140-1,2,4,5/ EN ISO 717-1	Airborne sound insulation	R _w (C;C _{tr})= 67 (-2;-7) dB*
BWR 6 Energy economy and heat retention		
EN 12664, EN 12667, EN 12939, EN ISO 8990, EN ISO 6946, EN ISO 14683, EN ISO 10211, EN ISO 10456	Thermal properties	No performance determined
EN ISO 12572, EN 12086, EN ISO 10456	Water vapour permeability	No performance determined

*Applicable only for Protecta FR Putty Pads in socket boxes

ASSESSMENT AND VERIFICATION OF CONSTANCY OF PERFORMANCE (HEREINAFTER AVCP) SYSTEM APPLIED, WITH REFERENCE TO ITS LEGAL BASE

According to the decision 1999/454/EC – Commission Decision of date 22nd June 1999 on the procedure for attesting the conformity of construction products pursuant to Article 20(2) of Council Directive 89/106/EEC as regards fire stopping, fire sealing and fire protective products, published in the Official Journal of the European Union (OJEU) L178/52 of 14/07/1999, (see <https://eur-lex.europa.eu/oj/direct-access.html>) of the European Commission¹, as amended, the system(s) of assessment and verification of constancy of performance (see Annex V to Regulation (EU) No 305/2011) given in the following table(s) applies (apply).

Product(s)	Intended use(s)	Level(s) or class(es)	System(s)
Fire stopping and Fire Sealing Products	For fire compartmentation and/or fire protection or fire performance	Any	1

4 Technical details necessary for the implementation of the AVCP system, as provided for in the applicable EAD

Tasks of the manufacturer:

Factory production control

The manufacturer shall exercise permanent internal control of production. All the elements, requirements and provisions adopted by the manufacturer shall be documented in a systematic manner in the form of written policies and procedures, including records of results performed. This production control system shall ensure that the product is in conformity with this European technical Assessment.

The manufacturer may only use initial / raw / constituent materials stated in the technical documentation of this European Technical Assessment.

The factory production control shall be in accordance with the Control Plan of 14th October 2021 relating to the European technical assessment ETA 21/0032 issued on 30/03/2022 which is part of the technical documentation of this European technical Assessment. The "Control Plan" is laid down in the context of the factory production control system operated by the manufacturer and deposited at UL International (Netherlands) B.V.

The results of factory production control shall be recorded and evaluated in accordance with the provisions of the Control Plan.

¹ Official Journal of the European Communities L178/52 of 14/7/1999

Other tasks of the manufacturer:

Additional information

The manufacturer shall provide a technical data sheet and an installation instruction with the following minimum information:

(a) Technical data sheet:

- Field of application:
- Building elements for which the penetration seal is suitable, type and properties of the building elements like minimum thickness, density, and - in case of lightweight constructions – the construction requirements.
- Limits in size, minimum thickness etc. of the penetration seal
- Construction of the penetration seal including the necessary components and additional products (e.g. backfilling material) with clear indication whether they are generic or specific.
- Services which the penetration seal is suitable, type and properties of the services like material, diameter, thickness etc. in case of pipes including insulation materials; necessary/allowed supports/fixings (e.g. pipe trays)

(b) Installation instruction:

- Steps to be followed
- Procedure in case of retrofitting
- Stipulations on maintenance, repair and replacement

5 Issued on:

30th March 2022

Report by:



D. Yates
Senior Project Engineer
Built Environment

Verified by:



C. Johnson
Senior Staff Engineer
Built Environment

Validated by:



Erik Teubler
Head of TAB
Built Environment

For and on behalf of UL International (Netherlands) B.V.

ANNEX A – Resistance to Fire Classification – Protecta FR Putty

A.1 Flexible wall constructions with wall thickness of minimum 100 mm

A.1.1 Pipe and cable penetration seals with 4 mm thick Protecta FR Putty in plastic socket box

Penetration Seal: Socket boxes placed back-to-back or side-by-side with zero distance, or further apart protected with Protecta FR Putty pads. The socket boxes can be fixed directly to drywall studs, or to timber noggins or steel plates fixed to studs.

Construction details:

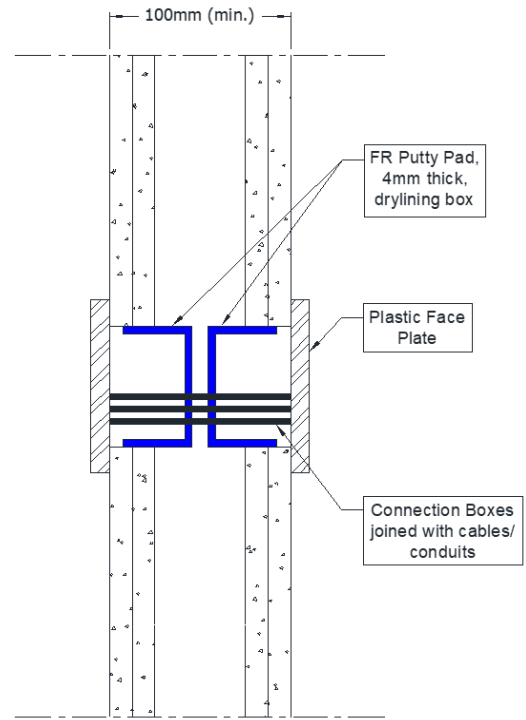
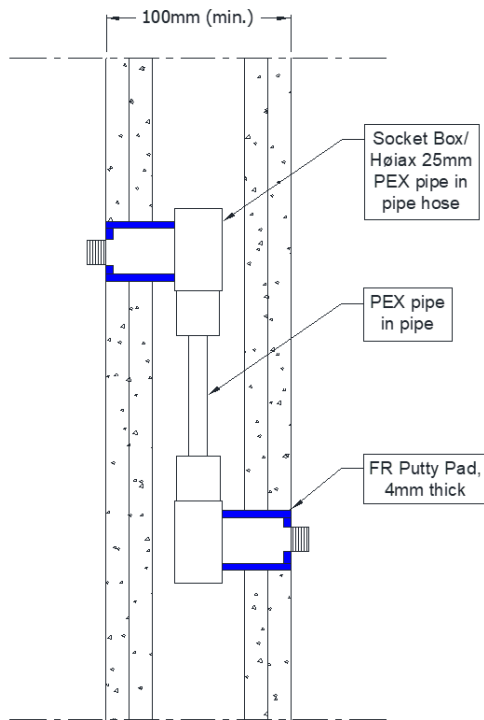

A.1.1.1 Double side penetration seal with pipes or cables in socket boxes

Services	Socket box	Protecta FR Putty - mm	Aperture mm	Classification
Høiax 25mm PEX pipe in pipe hose	Single or double Høiax Push Wallbox 15mm, fitted side-by-side	174 x 64 x 4 mm pad around pipe / 50 Ø x 25 mm at back of the box	63 Ø	EI 90
Cables up to 14 mm diameter	Plastic UK standard double socket box, maximum 130mm wide x 70mm high x 47mm deep, each with up to 22mm hole cut to accept the cables	Interior of box fully lined with pad	Maximum 135 wide x 75 high	EI 60

A.1.2 Cable penetration seals with 4 mm thick Protecta FR Putty in plastic socket box

Penetration Seal: Plastic socket boxes placed side-by-side with zero distance, or further apart protected with Protecta FR Putty pads. The socket boxes can be fixed directly to drywall studs, or to timber noggins or steel plates fixed to studs.

Construction details:

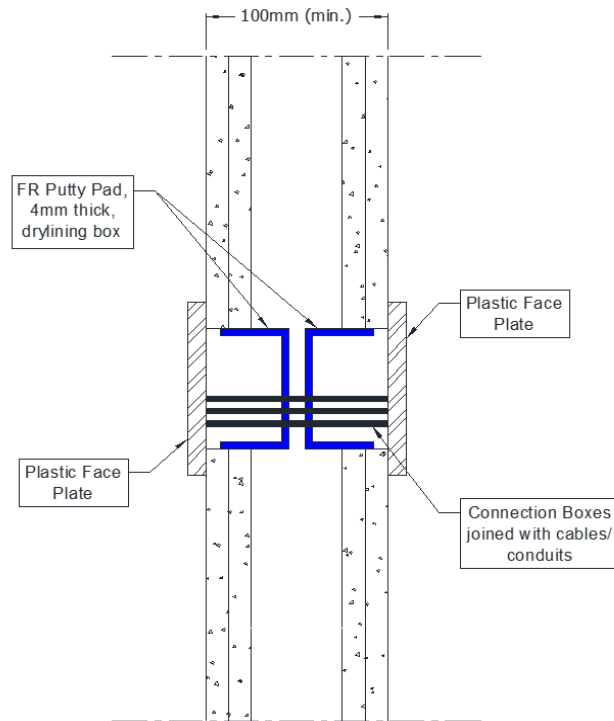

A.1.2.1 Double sided penetration seal with cables in socket boxes

Services	Socket box	Protecta FR Putty	Aperture mm	Classification
Cables up to 14 mm diameter	Schneider Electric Ref. IMT 36026 connection box, 72mm wide x 90mm high x 50mm deep	Fitted lining the back of the back box	73 wide x 91 High x 51 deep	E 60, EI 45
Cables up to 14 mm diameter	Elko 4189 1223720 connection box, 72mm wide x 90mm high x 58mm deep	Interior of box fully lined with pad	92 wide x 112 High	EI 90
Cables up to 14 mm diameter	ELKO 5421 123740 connection box, 73mm wide x 73mm high x 55mm deep	Interior of box fully lined with pad	74 wide x 74 High	EI 90

A.1.3 Cable penetration seals with 4 mm thick Protecta FR Putty in metallic socket box

Penetration Seal: Metallic socket boxes placed back-to-back or side-by-side with zero distance, or further apart protected with Protecta FR Putty pads. The socket boxes can be fixed directly to drywall studs, or to timber noggins or steel plates fixed to studs.

Construction details:

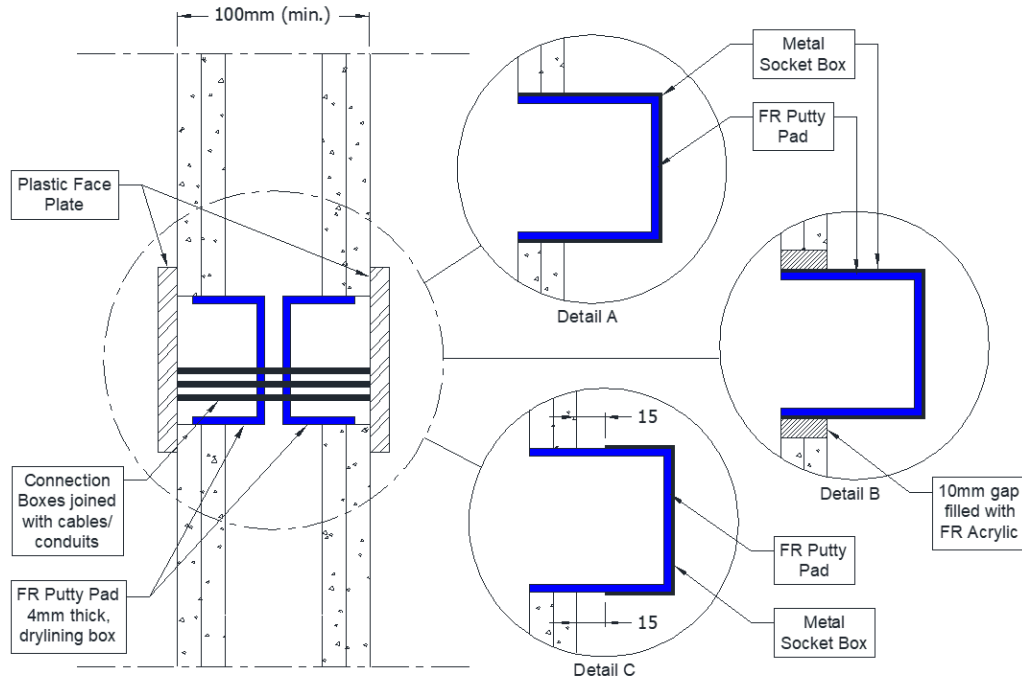

A.1.3.1 Double sided penetration seal with cables in socket boxes

Services	Steel standard UK double socket box with plastic socket cover	Protecta FR Putty pad	Detail drawing	Aperture mm (max)	Classification
Cables up to 14 mm diameter	Max. 134 mm wide x 74 mm high x 47 mm deep	Interior of box fully lined	A	134 x 74	E 90 EI 60
Cables up to 14 mm diameter	Max. 134 mm wide x 74 mm high x 47 mm deep with 25 mm metal extension box, fitted side-by-side	Interior of box fully lined	A	134 x 74	E 120 EI 60
Cables up to 14 mm diameter	Max. 134 mm wide x 74 mm high x 47 mm deep, fitted side-by-side, with max. 10 mm gap to plaster boards sealed with min. 12.5mm deep Protecta FR Acrylic	Interior of box fully lined	B	154 x 94	E 120 EI 90
Cables up to 14 mm diameter	Max. 134 mm wide x 74 mm high x 35 mm deep, fitted side-by-side, recessed with a max. 15 mm air gap between back box and plasterboard	Interior of box, air gap and plaster board fully lined	C	134 x 74	EI 90

A.1.4 Double sided penetration seal with cables

Penetration Seal: Cables (single or bundled up to 50 mm \varnothing) penetrating through a flexible or rigid wall construction and fitted at any position within the aperture, sealed with a 15mm diameter cord of Protecta FR Putty on both sides of the wall. Maximum annular space 10 mm (A1) and minimum separation between penetration seals 30 mm (A2).

Construction details:

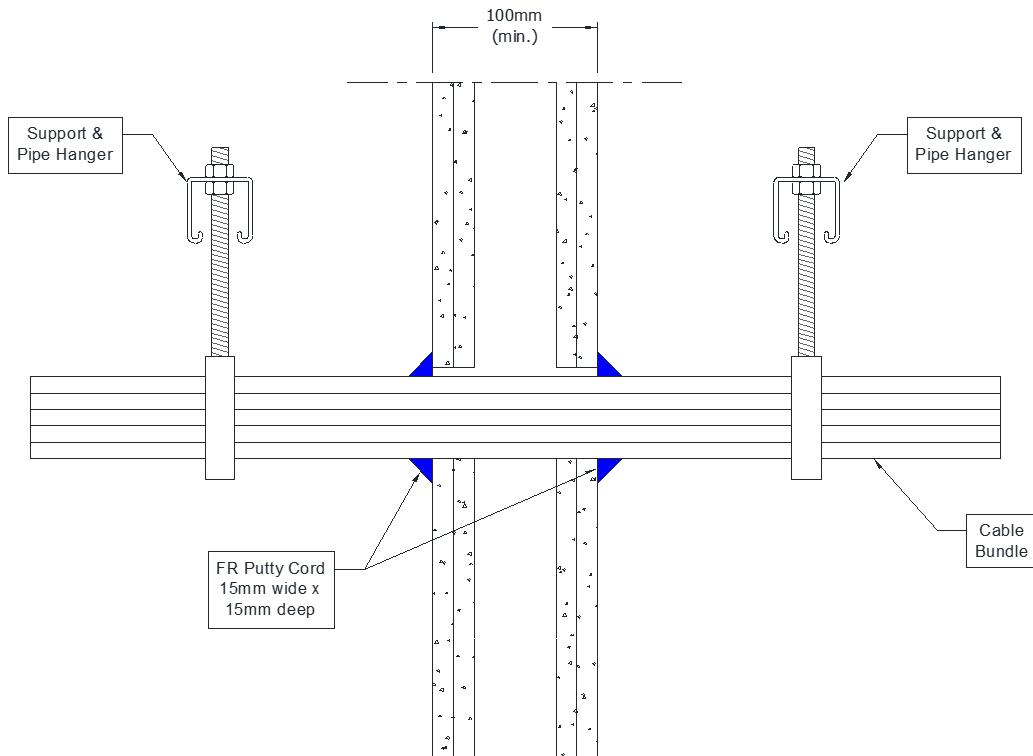

A.1.4.1

Services	Classification
Blank seal with a 15 mm deep cord of Protecta FR Putty on both sides of the wall	EI 120
Cables up to 21 mm diameter, single or in a bundle up to 50 mm diameter*	EI 120
Cables up to 80 mm diameter, single or in a bundle up to 50 mm diameter*	EI 60

* Cable specification from EN 1366-3 standard cable configuration

A.1.5 Double sided penetration seal with pipes

Penetration Seal: Pipes penetrating through a flexible or rigid wall construction and fitted at any position within the aperture, sealed with a 15mm diameter cord of Protecta FR Putty on both sides of the wall. Maximum annular space 10 mm (A1) and minimum separation between penetration seals 30 mm (A2).

Construction details:

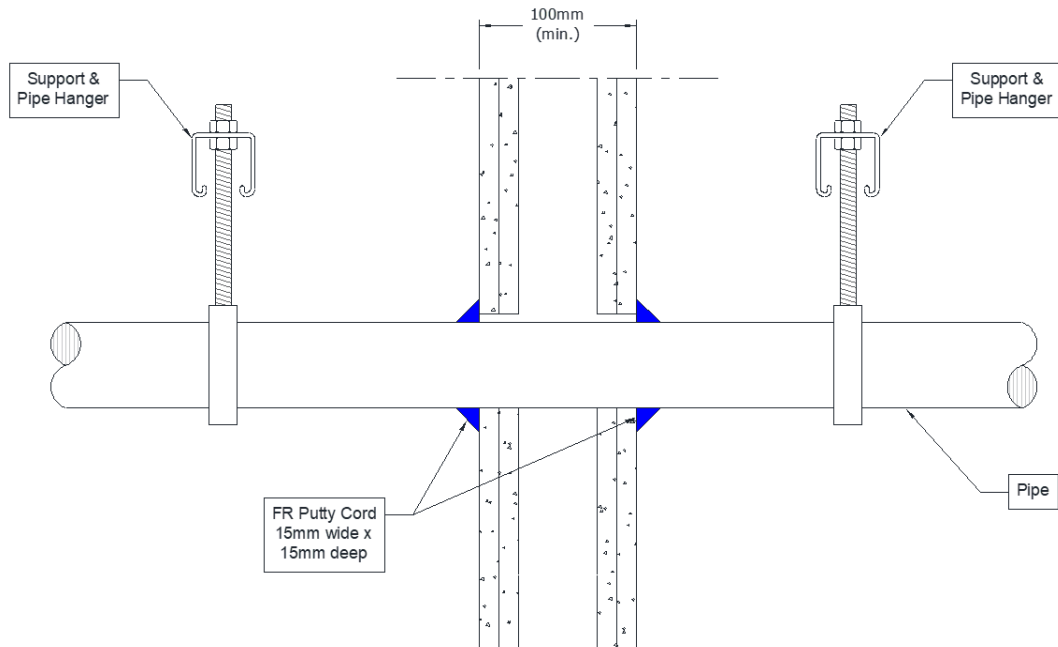

A.1.5.1

Services	Insulation	Classification
Mild or stainless steel pipe		
Maximum 22 mm diameter*	None needed	EI 120 C/U
23-30 mm diameter*	None needed	E 120, EI 45 C/U
ALUPEX pipe		
16 mm diameter*	None needed	EI 120 C/C
17-20 mm diameter*	None needed	E 120, EI 90 C/C
Copper or steel pipe		
6 mm diameter*	None needed	EI 120 C/C
7-12 mm diameter*	None needed	E 120, EI 60 C/C
PVC-U pipe according to EN 1329-1, EN 1452-1 and EN 1453-1 and PVC-C according to EN 1566-1		
PVC plastic pipe at maximum 25 mm diameter with 1.5 mm pipe wall thickness	None needed	EI 60 U/C

*See below graphs for interpolation pipe sizes

Mild or Stainless Steel Pipes - E1 120 C/C

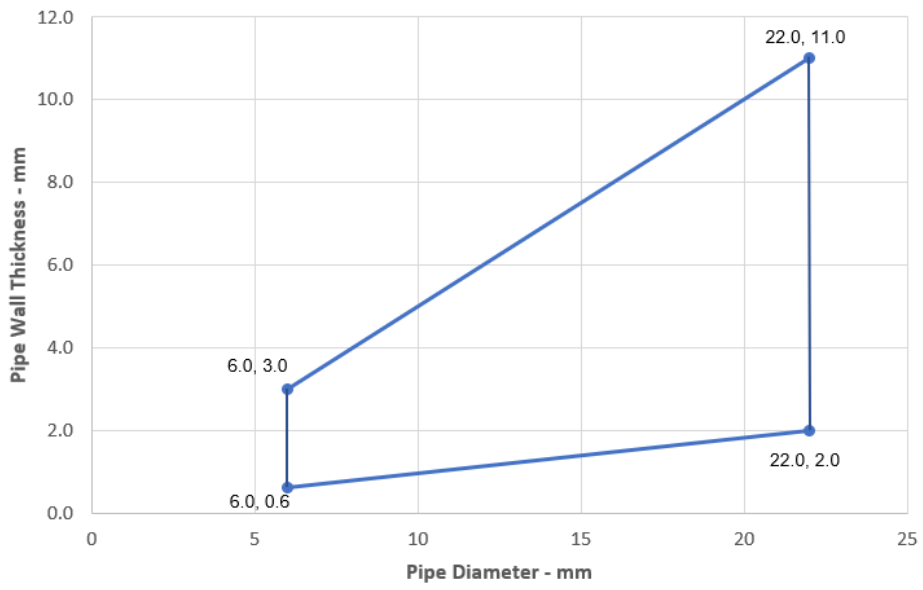

Steel Pipes - E 120, EI 45 C/U

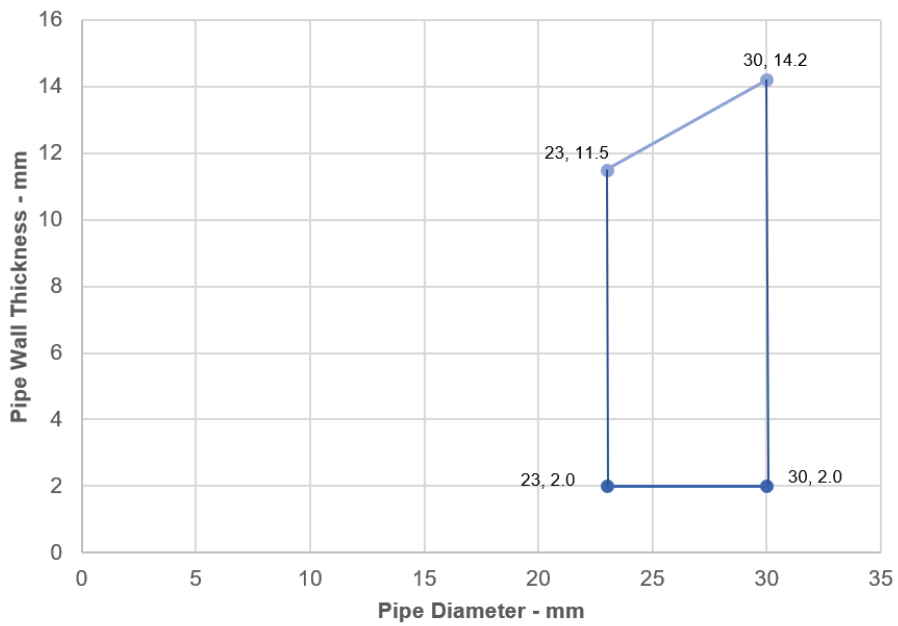

ALUPEX Pipes - E 120, EI 90 C/C

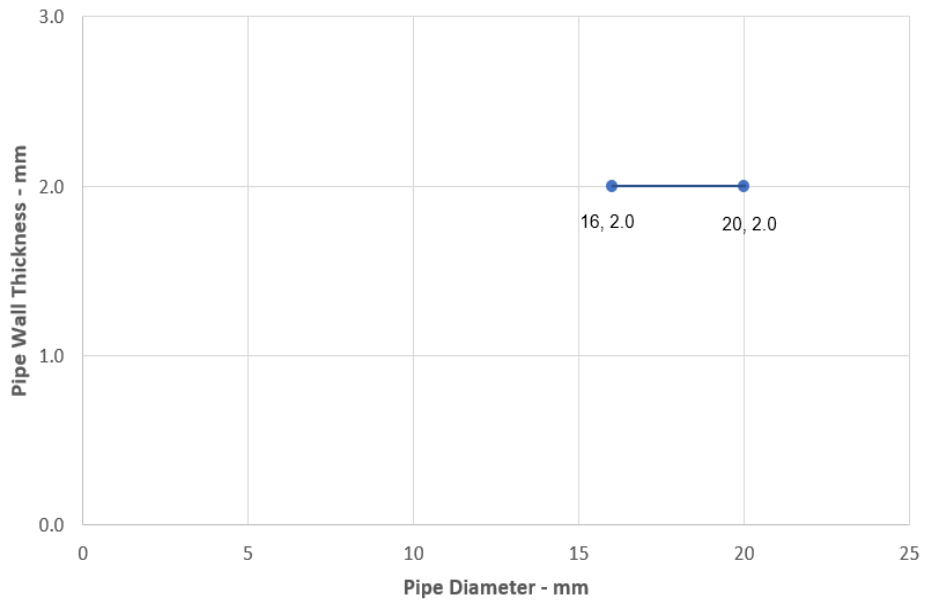

Copper Pipes- E120, EI 60 C/C

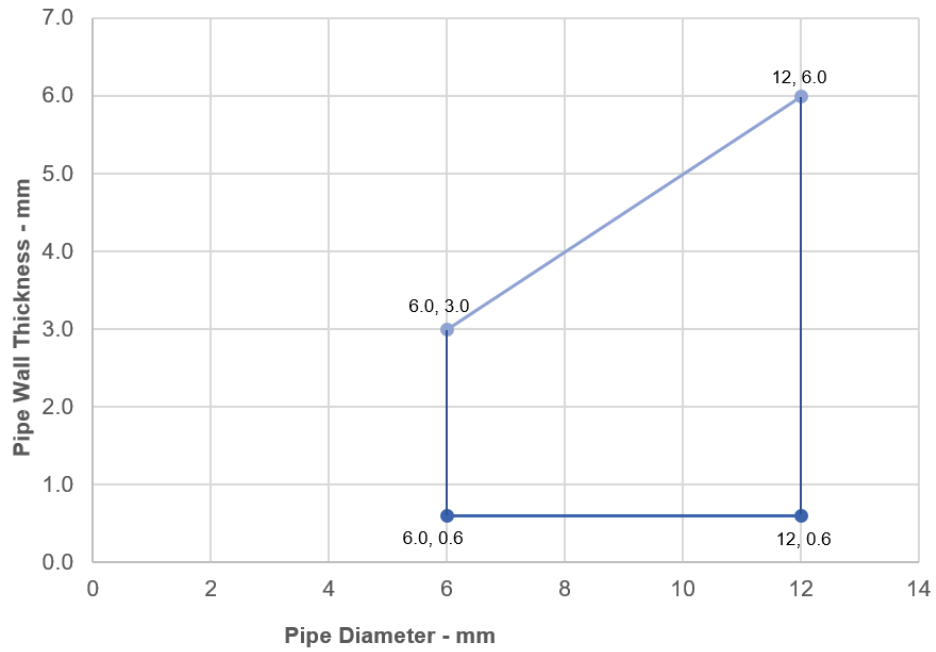

A.1.6 Double sided penetration seal with insulated metallic pipes, Local Interrupted (LI)

Penetration Seal: Metallic pipes insulated with minimum 80 kg/m³ density mineral wool insulation, Local Interrupted (LI), penetrating through a flexible or rigid wall construction, fitted at any position within the aperture, sealed with a 15mm diameter cord of Protecta FR Putty on both sides of the wall. Maximum annular space 10 mm (A1) and minimum separation between penetration seals 30 mm (A2).

Construction details:

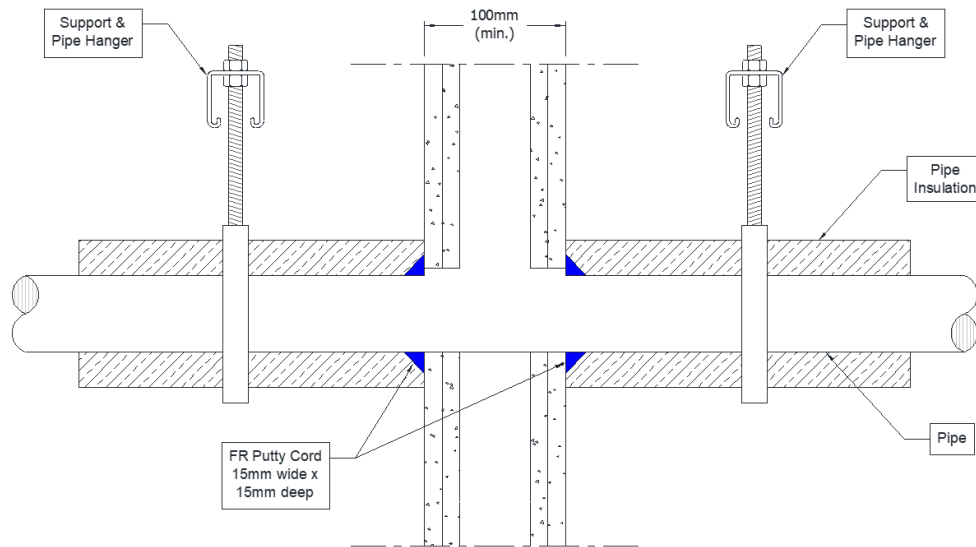

A.1.6.1

Services	Insulation	Classification
Mild or stainless steel pipe, with minimum 80 kg/m ³ density mineral wool insulation		
Maximum 40 mm diameter*	Minimum 20 mm thick insulation, 500 mm long butted up to the wall on both faces	EI 120 C/U
40-324 mm diameter*	Minimum 30 mm thick insulation, 500 mm long butted up to the wall on both faces	EI 120 C/U
Copper or steel pipe with minimum 80 kg/m ³ density mineral wool insulation		
Maximum 54 mm diameter/1.2-14.2 mm wall	Minimum 20 mm thick insulation, 500 mm long butted up to the wall on both faces	E 90, EI 60 C/C
ALUPEX pipe with minimum 80 kg/m ³ density mineral wool insulation		
Maximum 16 mm diameter*	Minimum 20 mm thick insulation, 500 mm long butted up to the wall on both faces	EI 90 C/C
Maximum 75 mm diameter*	Minimum 30 mm thick insulation, 500 mm long butted up to the wall on both faces	EI 90 C/C

*See below graphs for interpolation pipe sizes

Steel Pipes- EI 120, C/U

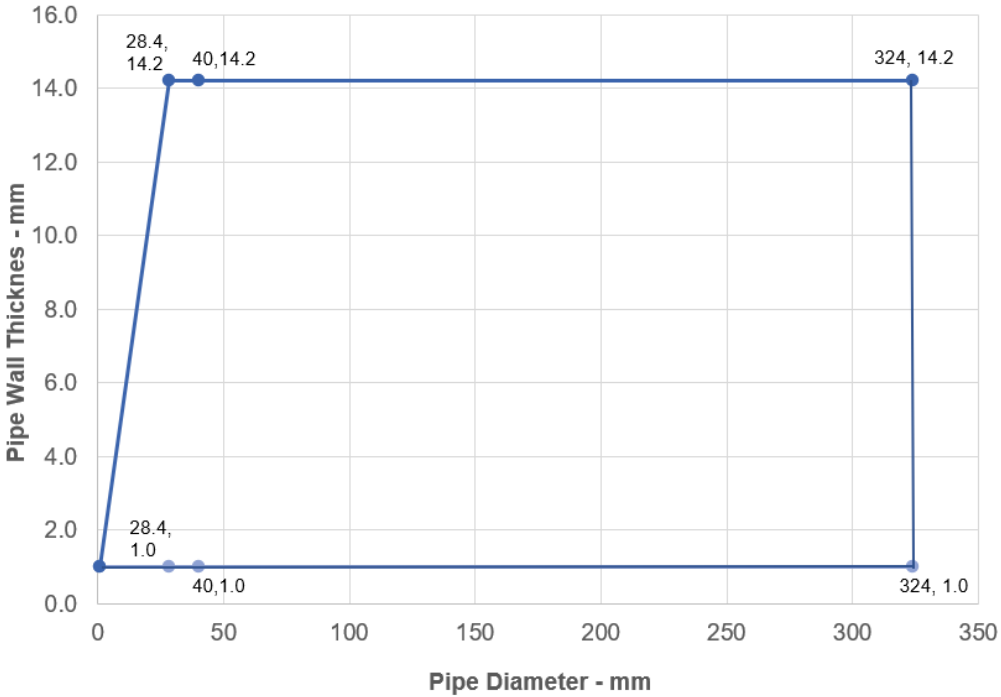

ALUPEX Pipes with 30 mm Thick Insulation - EI 90 C/C

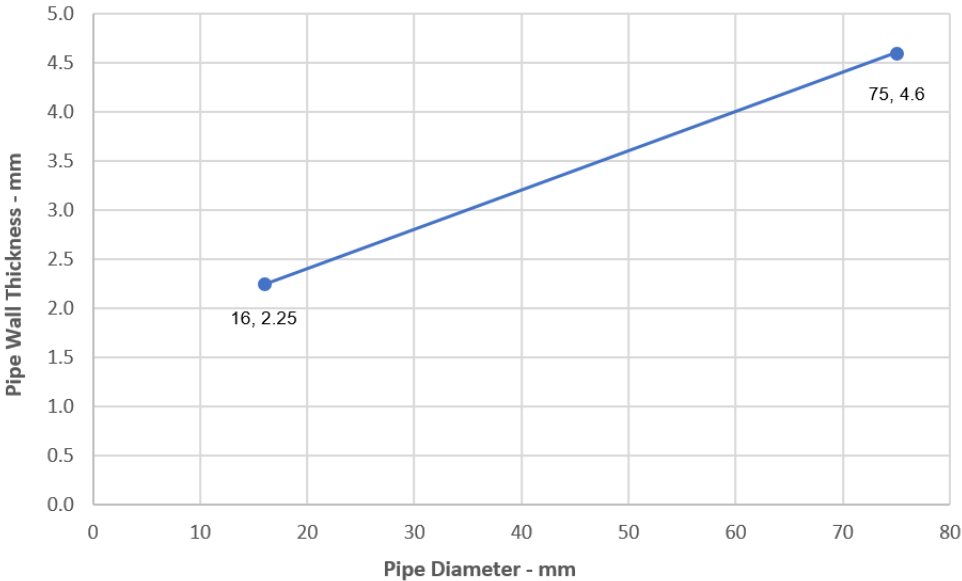

A.1.7 Double sided penetration seal with insulated metallic pipes, Continuous Sustained (CS)

Penetration Seal: Metallic pipes insulated with minimum 80 kg/m³ density mineral wool insulation, Continuous Sustained (CS), penetrating through a flexible or rigid wall construction, fitted at any position within the aperture, sealed with a 15mm diameter cord of Protecta FR Putty on both sides of the wall. Maximum annular space 10 mm (A1) and minimum separation between penetration seals 30 mm (A2).

Construction details:

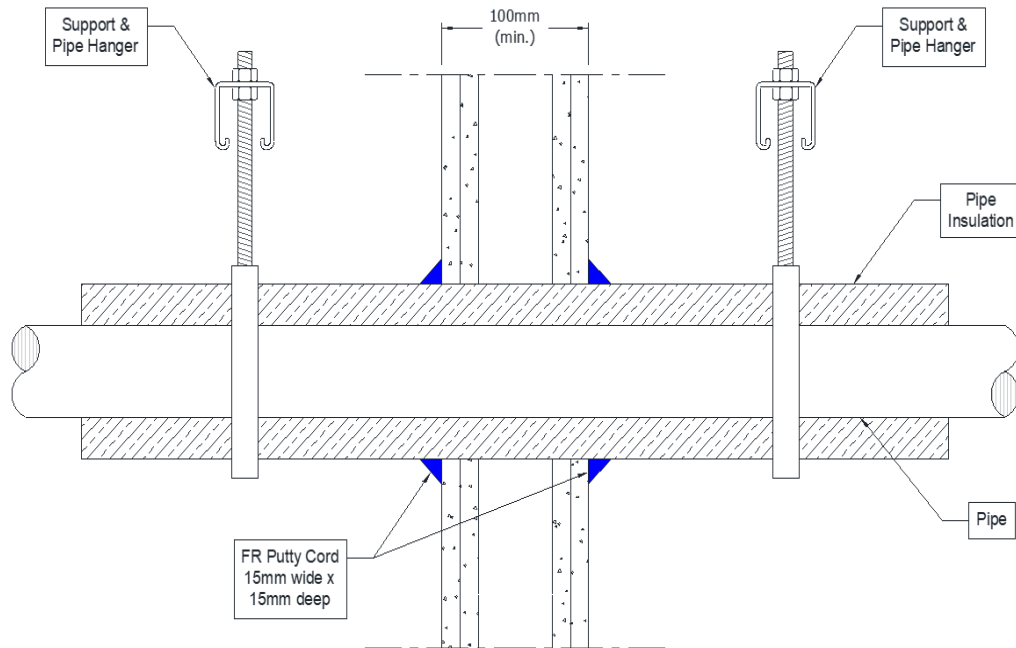

A.1.7.1

Services	Insulation	Classification
Mild or stainless steel pipe, with minimum 80 kg/m ³ density mineral wool insulation		
Maximum 40 mm diameter*	20 mm thick	EI 120 C/U
40-324 mm diameter*	30-80 mm thick	E 90, EI 60 C/U
Copper or steel pipe with minimum 80 kg/m ³ density mineral wool insulation		
Maximum 12 mm diameter/0.7-6.0 mm wall*	20 mm thick	E90, EI 60 C/C
Maximum 54 mm diameter/1.2-14.2 mm wall,	30-80 mm thick	E 90, EI 60 C/C
ALUPEX pipe with minimum 80 kg/m ³ density mineral wool insulation		
Maximum 16 mm diameter*	20 mm thick	EI 90 C/C
Maximum 75 mm diameter*	30-80 mm thick	EI 90 C/C

*See below graphs for interpolation pipe sizes

Steel Pipes- E 90, EI 60, C/U

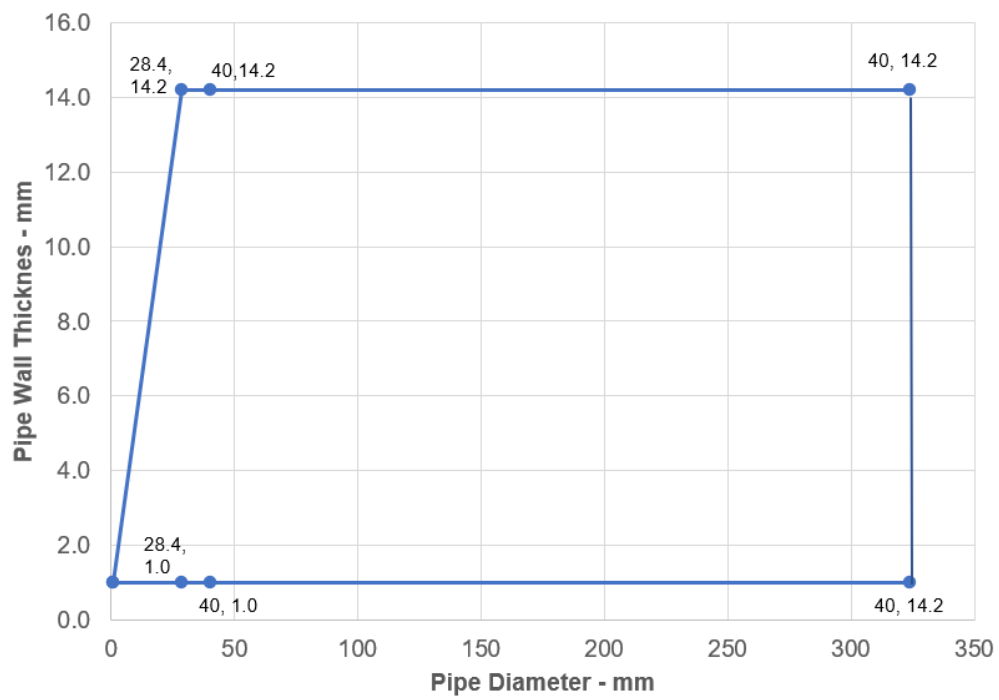

Copper or Steel Pipes with 30-80 mm Thick Insulation - E 90, EI 60, C/C

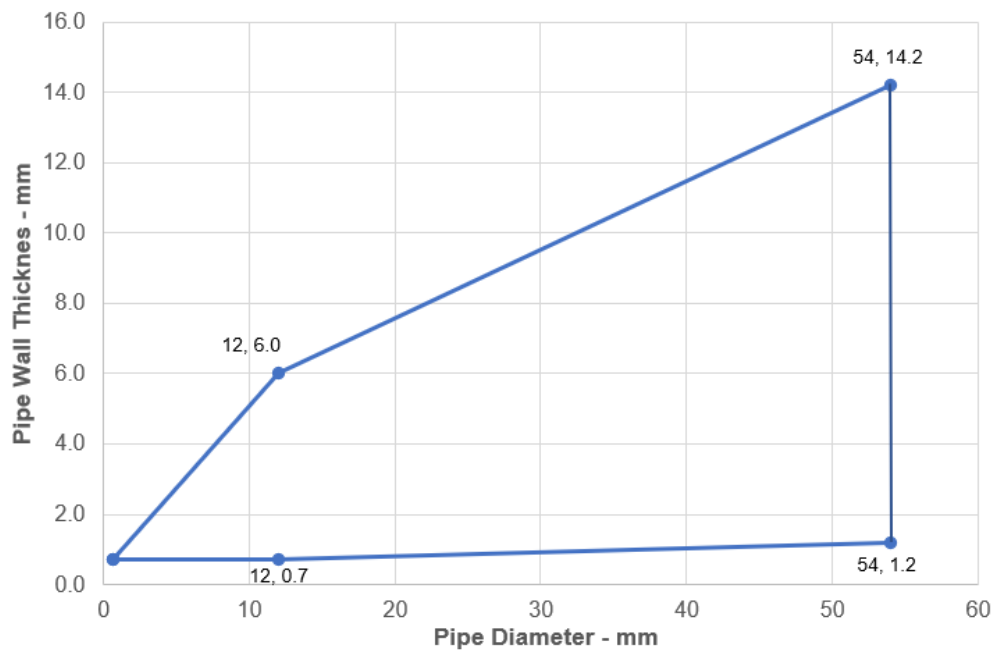

ALUPEX Pipes with 30-80 mm Thick Insulation - EI 90 C/C

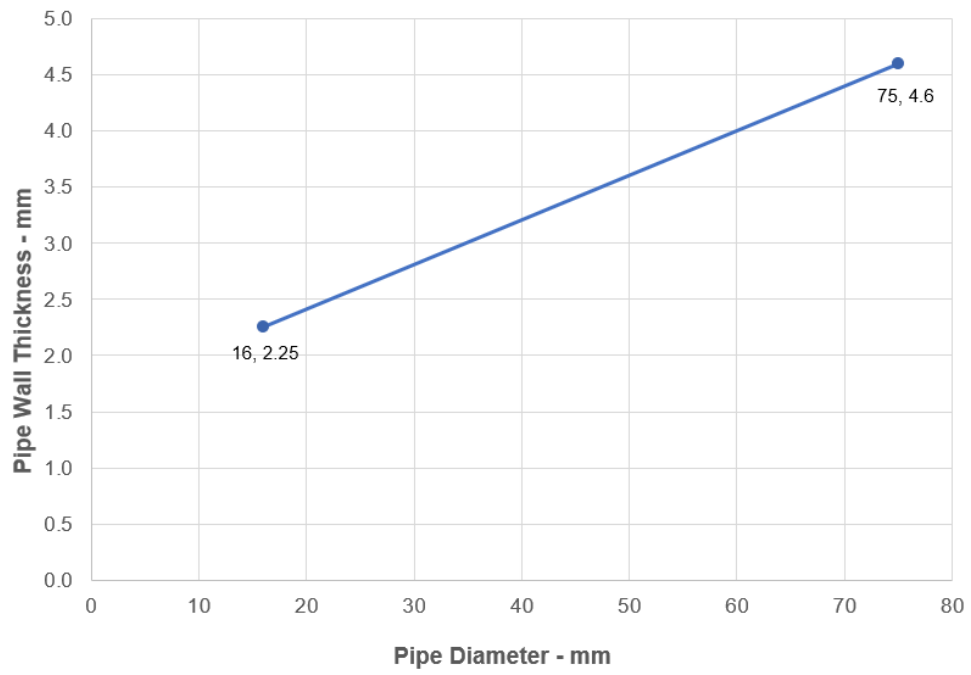

A.2 Flexible wall constructions with wall thickness of minimum 120 mm

A.2.1 Cable penetration seals with 4 mm thick Protecta FR Putty in plastic socket box

Penetration Seal: Socket boxes placed back-to-back or side-by-side with zero distance, or further apart protected with Protecta FR Putty pads. The socket boxes can be fixed directly to drywall studs, or to timber noggins or steel plates fixed to studs.

Construction details:

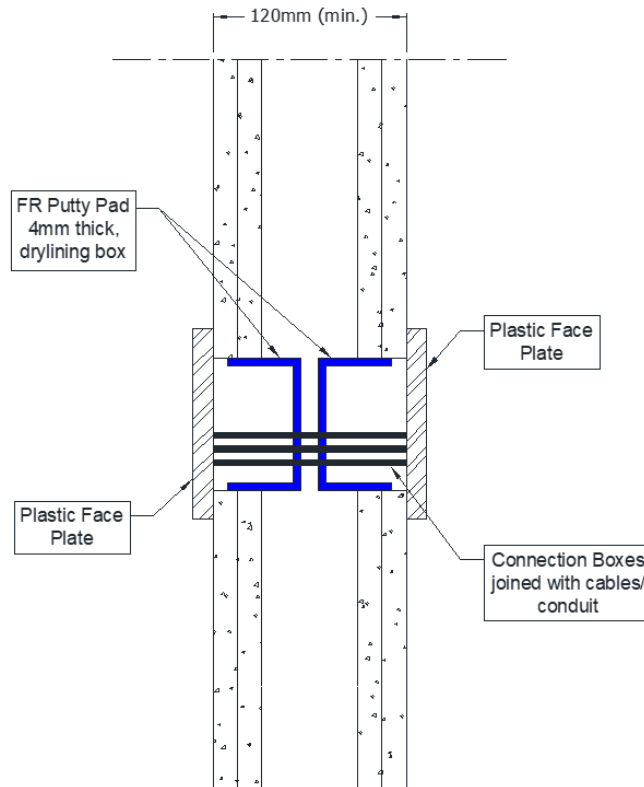

A.2.1.1 Double side penetration seal with cables in plastic socket boxes

Services	Socket box	Protecta FR Putty	Aperture mm	Classification
Cables up to 14 mm diameter	UK standard double socket box, maximum 130mm wide x 70mm high x 48mm deep, each with a 25mm wide x 14mm high knock out section to accept the cables	Interior of box fully lined with pad	Maximum 135 wide x 72 High	EI 120
2.5 mm twin and earth cables				

A.2.2 Double sided penetration seal with metallic pipes

Penetration Seal: Metallic pipes penetrating through a flexible or rigid wall construction and fitted at any position within the aperture, sealed with a 15mm diameter cord of Protecta FR Putty on both sides of the wall. Maximum annular space 10 mm (A1) and minimum separation between penetration seals 30 mm (A2).

Construction details:

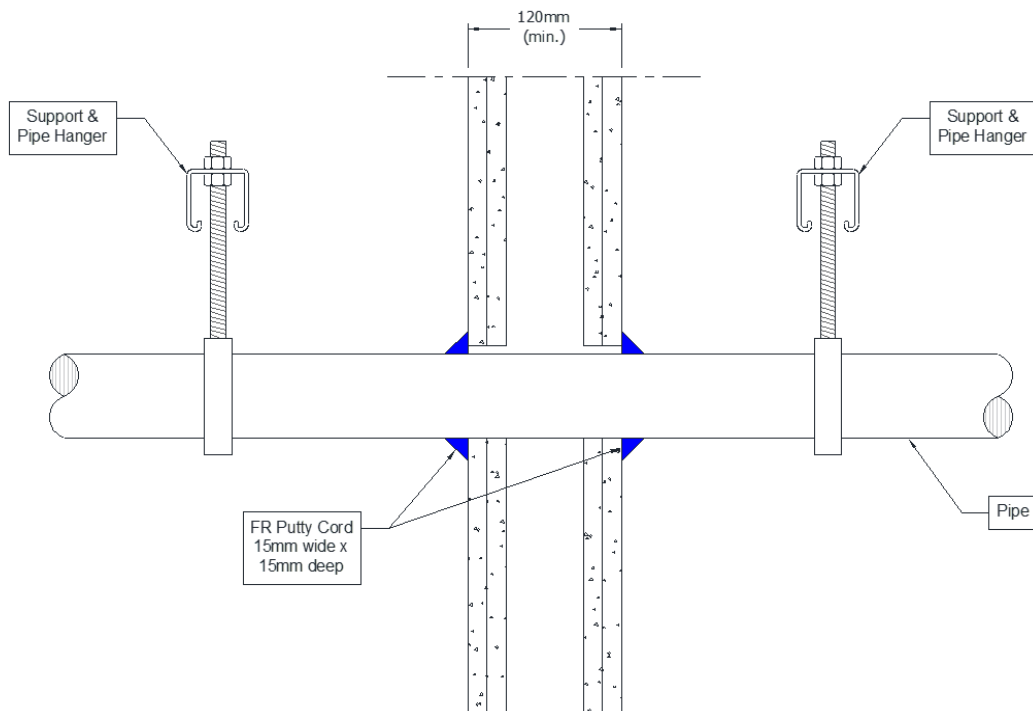

A.2.2.1

Services	Insulation	Classification
Mild or stainless steel pipe		
Maximum 324 mm diameter/6.35-14.2 mm wall	None needed	E 90, EI 20 C/U
ALUPEX pipe		
Maximum 75 mm diameter/4.6-14.2 mm wall	None needed	EI 90 C/C
Copper or steel pipe		
Maximum 54 mm diameter/1.2-14.2 mm wall	None needed	E 90, EI 15 C/C

A.3 Rigid wall constructions with wall thickness of minimum 150 mm

A.3.1 Double sided penetration seal with insulated metallic pipes, Continuous Sustained (CS)

Penetration Seal: Metallic pipes insulated with minimum 80 kg/m³ density mineral wool insulation, Continuous Sustained (CS), penetrating through a rigid wall construction, fitted at any position within the aperture, sealed with a 15mm diameter cord of Protecta FR Putty on both sides of the wall. Maximum annular space 10 mm (A1) and minimum separation between penetration seals 30 mm (A2).

Construction details:

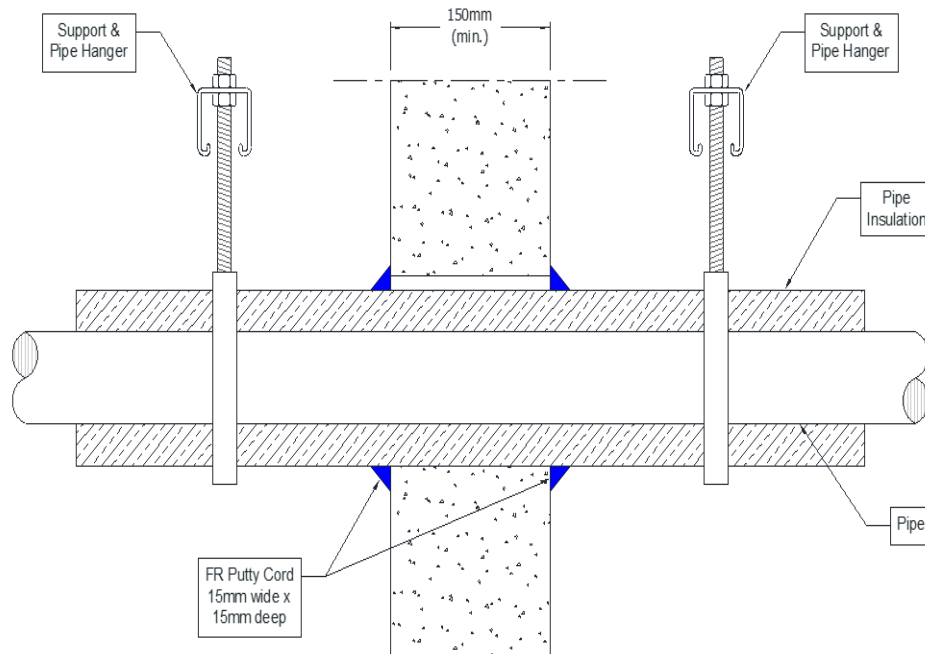

A.3.1.1

Services	Insulation	Classification
Mild or stainless steel pipe, with minimum 80 kg/m ³ density mineral wool insulation		
Maximum 40 mm diameter*	20 mm thick	EI 120 C/U
Maximum 324 mm diameter*	30-80 mm thick	E 240, EI 180 C/U
Copper or steel pipe with minimum 80 kg/m ³ density mineral wool insulation		
Maximum 54 mm diameter/1.2-14.2 mm wall	20 mm thick	E 240, EI 120 C/C
ALUPEX pipe with minimum 80 kg/m ³ density mineral wool insulation		
Maximum 16 mm diameter*	20 mm thick	EI 240 C/C
Maximum 75 mm diameter*	30 mm thick	EI 240 C/C

*See below graphs for interpolation pipe sizes

Mild or Stainless Steel Pipes with 30 - 80 mm Thick Insulation - E 240, EI 180 C/U

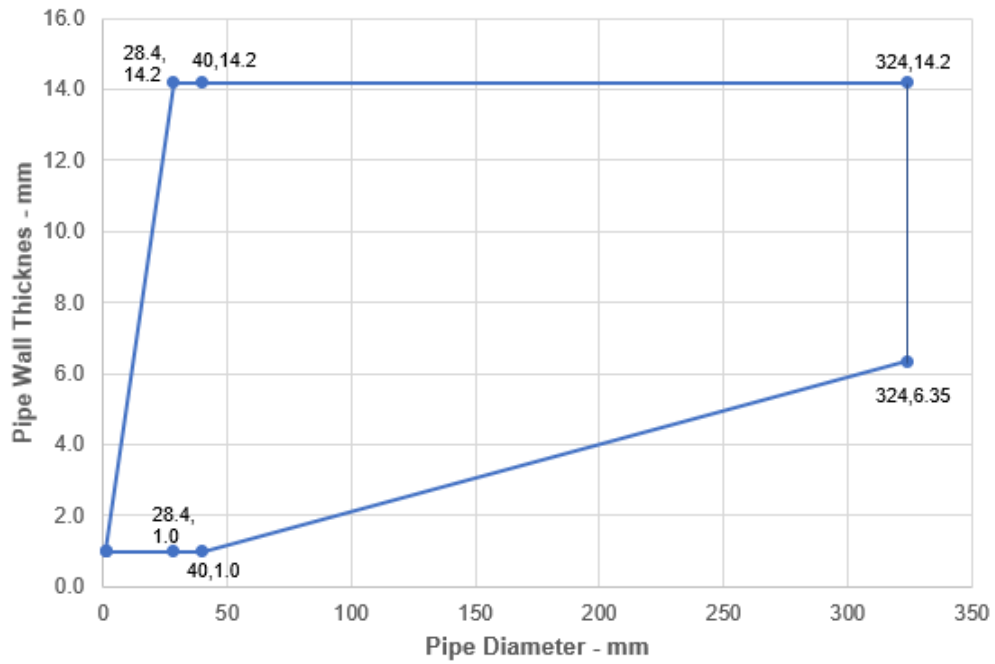

ALUPEX Pipes with 30 mm Thick Insulation - EI 240 C/C

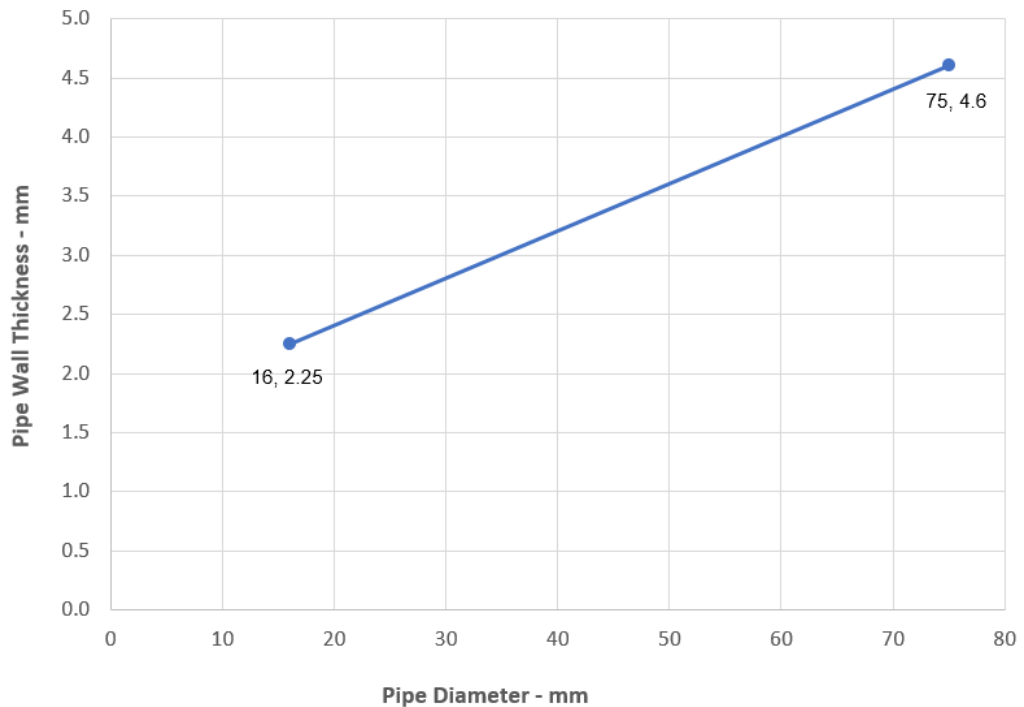

A.4 Rigid floor constructions with floor thickness of minimum 150 mm

A.4.1 Single sided penetration seal with cables

Penetration Seal: Cables (single or bundled up to 50 mm \varnothing) penetrating through a rigid floor construction and fitted at any position within the aperture, sealed with a 15mm diameter cord of Protecta FR Putty on the top face of the floor. Maximum annular space 10 mm (A1) and minimum separation between penetration seals 30 mm (A2). When incorporating blank penetration seals, the aperture is sealed with 15mm wide by 15mm thick cord of Protecta FR Putty, applied flush with the bottom face of the floor.

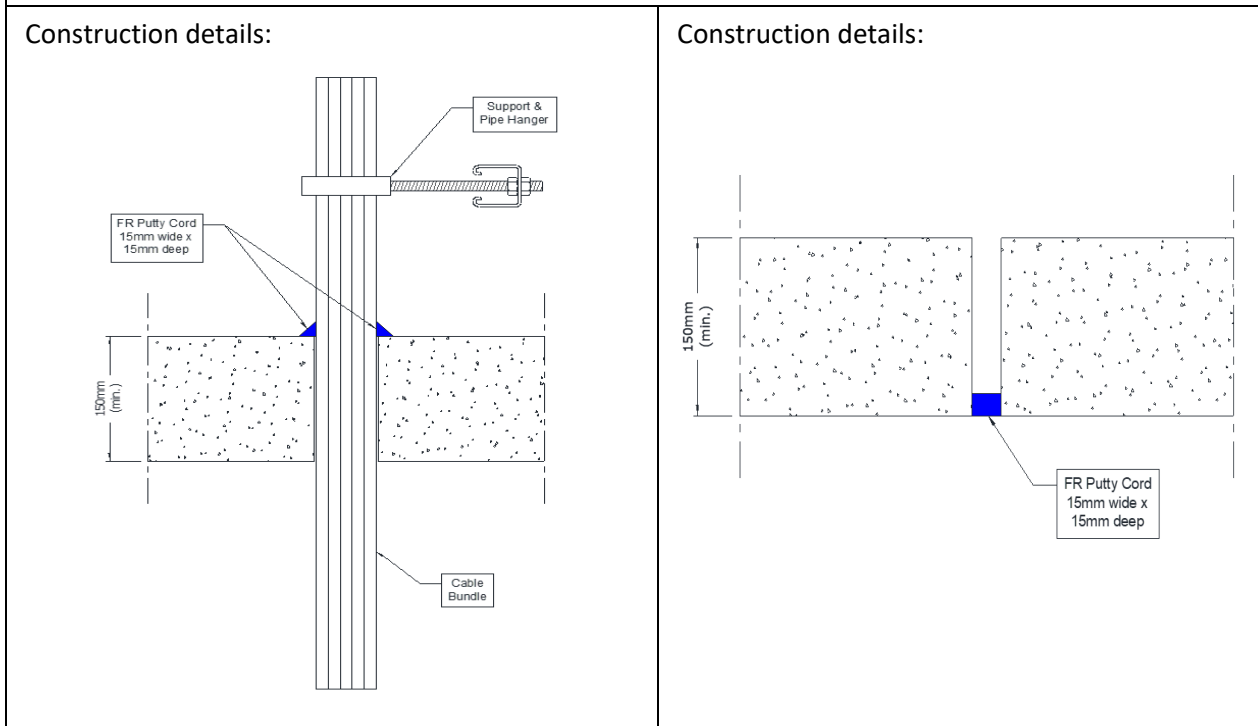

A.4.1.1

Services	Classification
None (blank)	E 120, EI 30
Cables up to 21 mm diameter in tied bundles up to 50 mm diameter*	E 120, EI 60
Cables up to 21 mm diameter*	EI 120
Cables 22-50 mm diameter*	E 120, EI 90
Cables 51-80 mm diameter*	E 120, EI 60
Single 'A1' type cable*	EI 240
Single 'C3' type cable*	EI 240
Single 'E' type cable*	EI 120
Single 'D1' type cable*	EI 120
Single 'D2' type cable*	EI 120
Single 'D3' type cable*	E 240, EI 60

* Cable specification from EN 1366-3 standard cable configuration

A.4.2 Single sided penetration seal with cables

Penetration Seal: Cables (single or bundled up to 75 mm \varnothing) penetrating through a rigid floor construction and fitted at any position within the aperture, sealed with a 15mm diameter cord of Protecta FR Putty on the bottom face of the floor. Maximum annular space 10 mm (A1) and minimum separation between penetration seals 30 mm (A2). When incorporating blank penetration seals, the aperture is sealed with 15mm wide by 15mm thick cord of Protecta FR Putty, applied flush with both faces of the floor.

Construction details:

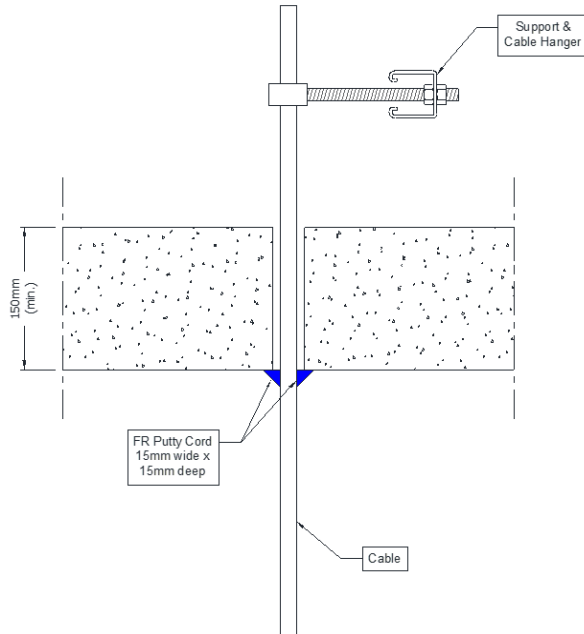

Construction details:

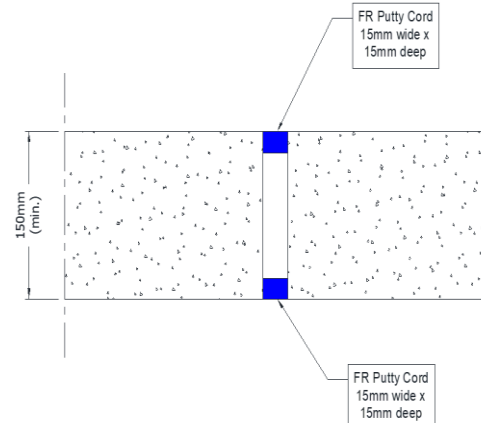

A.4.2.1

Services	Seal size	Classification
None (blank)	15mm deep	EI 120
Cables up to 21 mm diameter in tied bundles up to 75mm diameter*	15 mm diameter cord	E 60, EI 45
Cables up to 21 mm diameter*		E 120, EI 60
Cables 22-80 mm diameter*		E 90, EI 45

* Cable specification from EN 1366-3 standard cable configuration

A.4.3 Double sided penetration seal with cables

Penetration Seal: Cables (single or bundled up to 50 mm \varnothing) penetrating through a rigid floor construction and fitted at any position within the aperture, sealed with a 15mm diameter cord of Protecta FR Putty on both sides of the floor. Maximum annular space 10 mm (A1) and minimum separation between penetration seals 30 mm (A2).

Construction details:

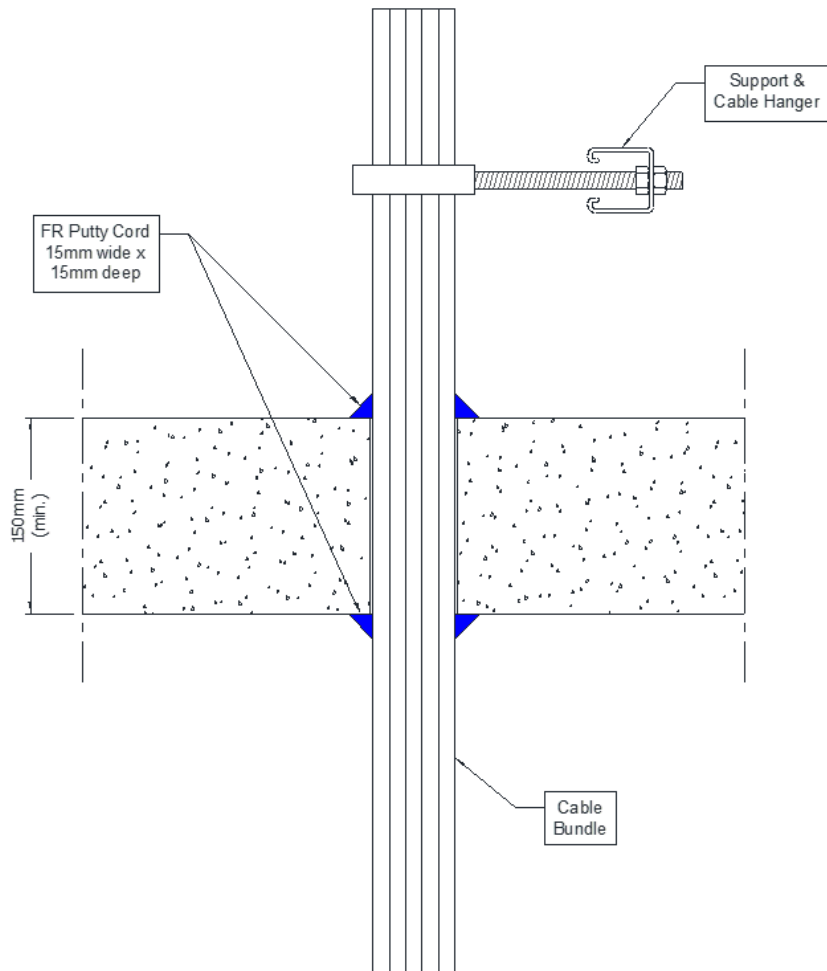

A.4.3.1

Services	Seal size	Classification
Cables up to 21 mm diameter in tied bundles up to 50 mm diameter*	15 mm diameter cord	EI 240

* Cable specification from EN 1366-3 standard cable configuration

A.4.4 Single sided penetration seal with metallic pipes

Penetration Seal: Metallic pipes penetrating through a rigid floor construction and fitted at any position within the aperture, sealed with a 15mm diameter cord of Protecta FR Putty on the bottom face of the floor. Maximum annular space 10 mm (A1) and minimum separation between penetration seals 30 mm (A2).

Construction details:

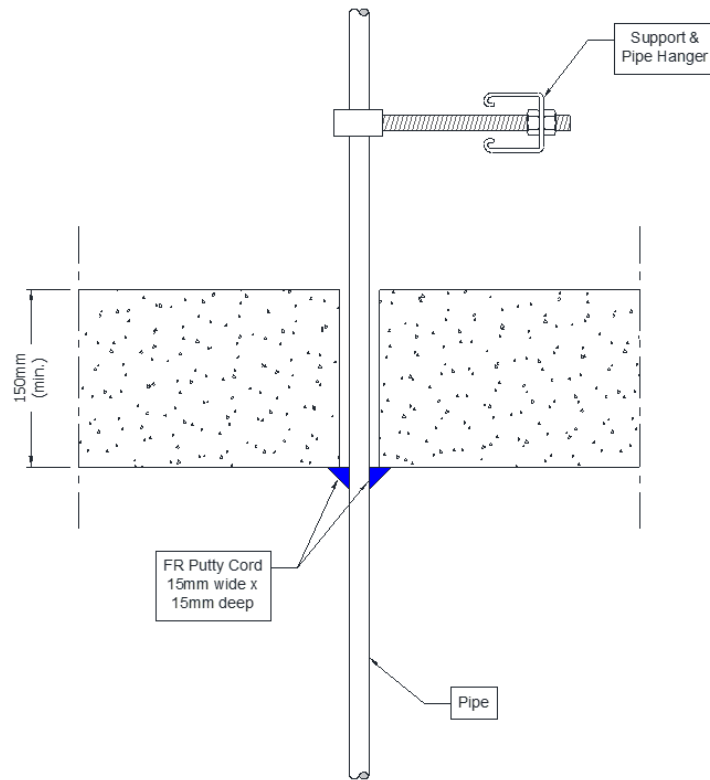

A.4.4.1

Services	Insulation	Classification
Mild or stainless steel pipe		
4 mm diameter*	None needed	EI 120 C/U
5-30 mm diameter*	None needed	E 120, EI 45 C/U
Copper or steel pipe		
6 mm diameter*	None needed	E 120, EI 90 C/C
7-12 mm diameter*	None needed	E 120, EI 30 C/C

*See below graphs for interpolation pipe sizes

Steel Pipes - E 120, EI 45 C/U

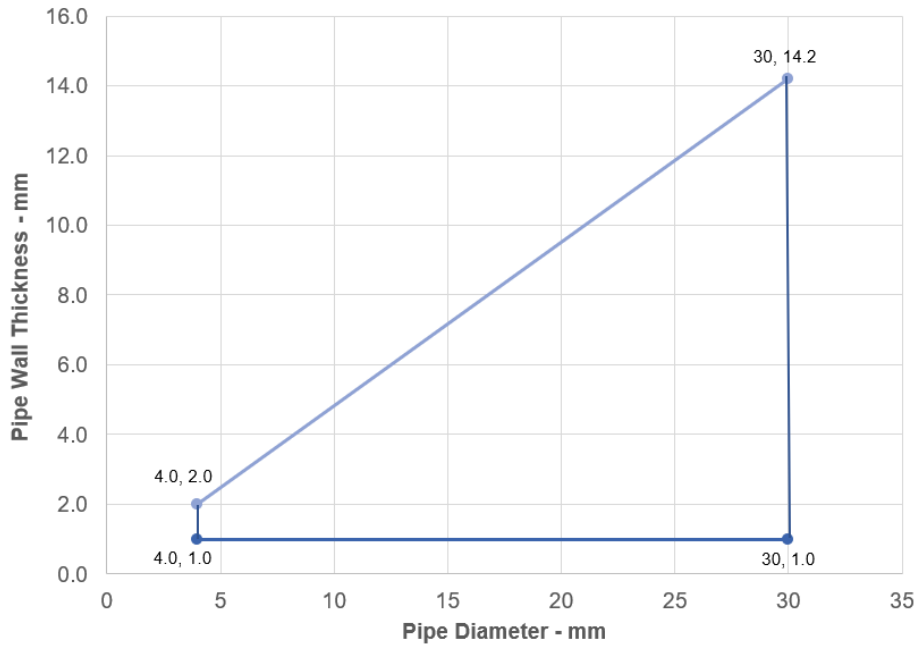

Copper Pipes - E 120, EI 30 C/C

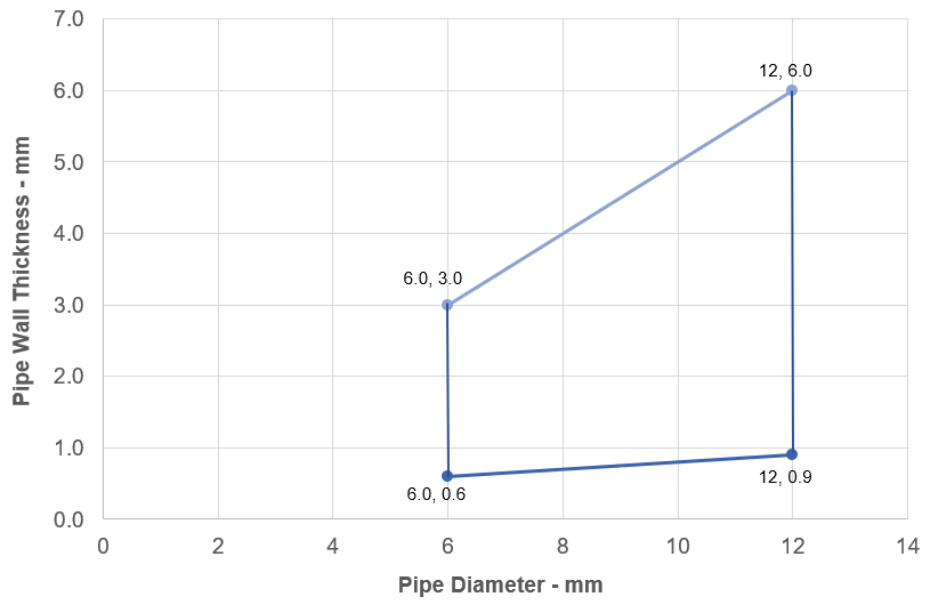

A.4.5 Single sided penetration seal with metallic pipes

Penetration Seal: Metallic pipes penetrating through a rigid floor construction and fitted at any position within the aperture, sealed with a 15mm diameter cord of Protecta FR Putty on the top face of the floor. Maximum annular space 10 mm (A1) and minimum separation between penetration seals 30 mm (A2).

Construction details:

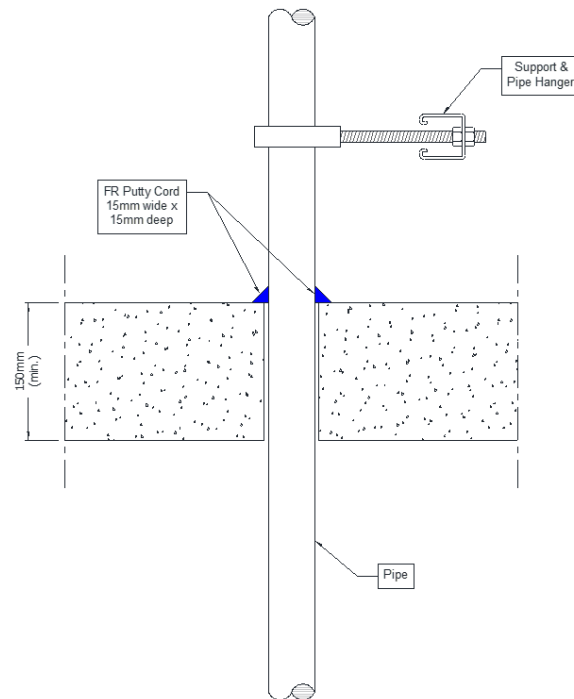

A.4.5.1

Services	Insulation	Classification
Mild or stainless steel pipe		
Maximum 22 mm diameter/1.2-11.0 mm wall*	None needed	EI 120 C/U
Maximum 324 mm diameter/6.35-14.2 mm wall*	None needed	E 240, EI 15 C/U
Copper or steel pipe		
6 mm diameter*	None needed	EI 120 C/C
7-10 mm diameter*	None needed	E 120, EI 90 C/C
Maximum 54 mm diameter/1.2-14.2 mm wall	None needed	E 120 C/C
ALUPEX pipe		
16-20 mm diameter*	None needed	EI 240 C/C
Maximum 75 mm diameter/4.6-14.2 mm wall	None needed	E 45, EI 30 C/C

*See below graphs for interpolation pipe sizes

Steel Pipes - E 120, EI 15 C/U

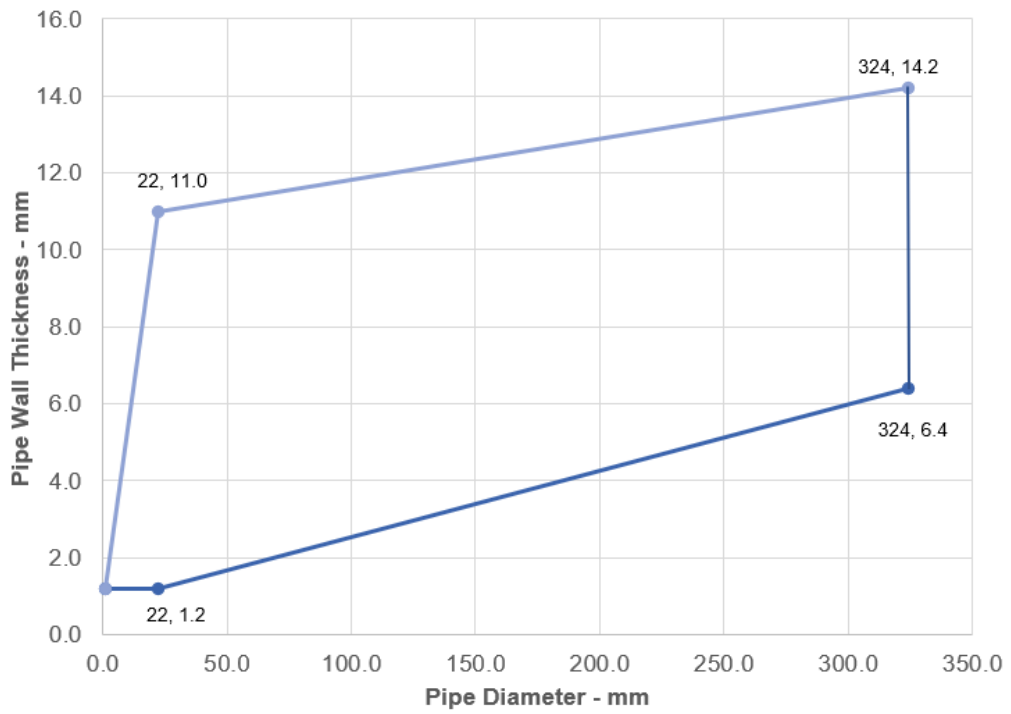

Copper or Steel Pipes - E 120, EI 90 C/C

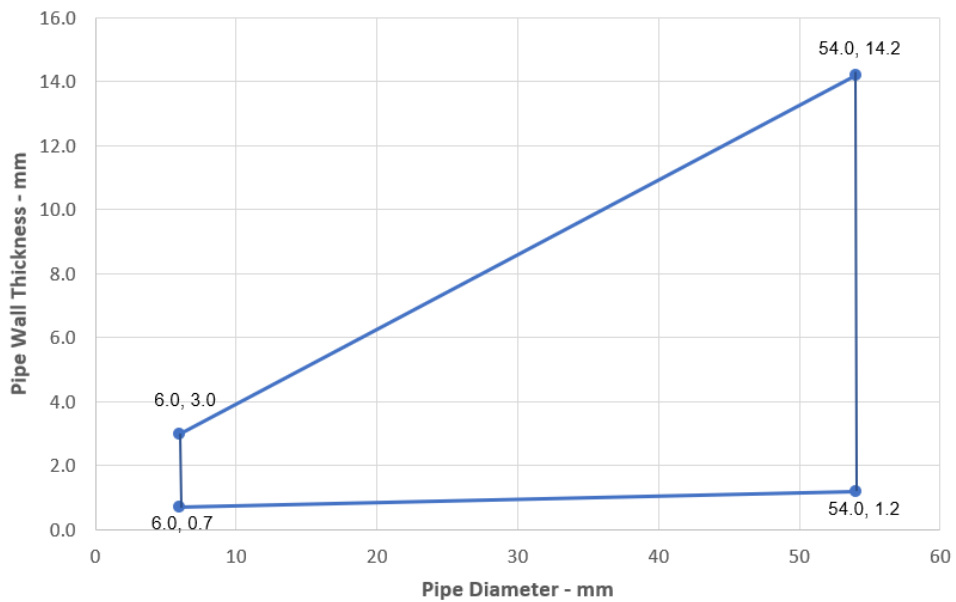

Alupex Pipes - EI 240 C/C

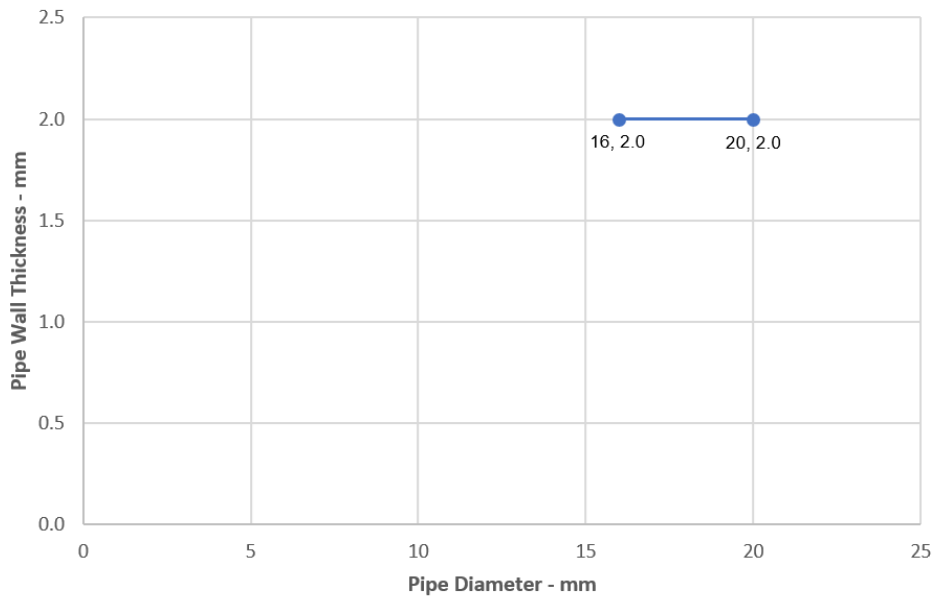

A.4.6 Double sided penetration seal with metallic pipes

Penetration Seal: Metallic pipes penetrating through a rigid floor construction and fitted at any position within the aperture, sealed with a 15mm diameter cord of Protecta FR Putty on both sides of the floor. Maximum annular space 10 mm (A1) and minimum separation between penetration seals 30 mm (A2).

Construction details:

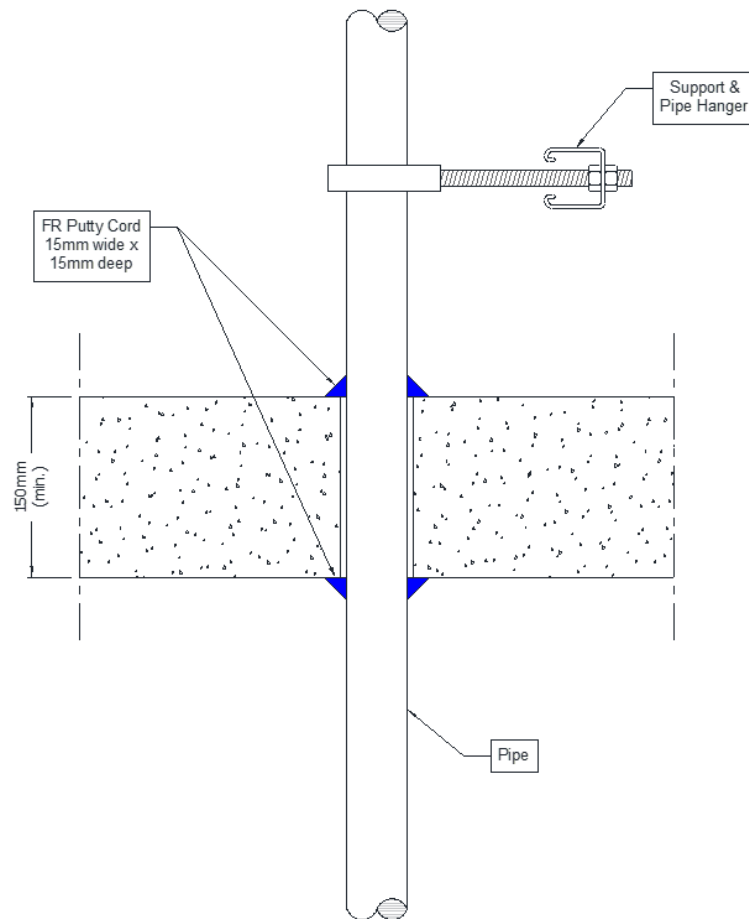

A.4.6.1

Services	Insulation	Classification
Copper or steel pipe		
Maximum 10 mm diameter/0.7-14.2 mm wall	None needed	E 240, EI 180 C/C

A.4.7 Single sided penetration seal with insulated metallic pipes, Local Interrupted (LI)

Penetration Seal: Metallic pipes insulated with minimum 80 kg/m³ density mineral wool insulation, Local Interrupted (LI), penetrating through a rigid floor construction, fitted at any position within the aperture, sealed with a 15 mm diameter cord of Protecta FR Putty on the top face of the floor. Maximum annular space 10 mm (A1) and minimum separation between penetration seals 30 mm (A2).

Construction details:

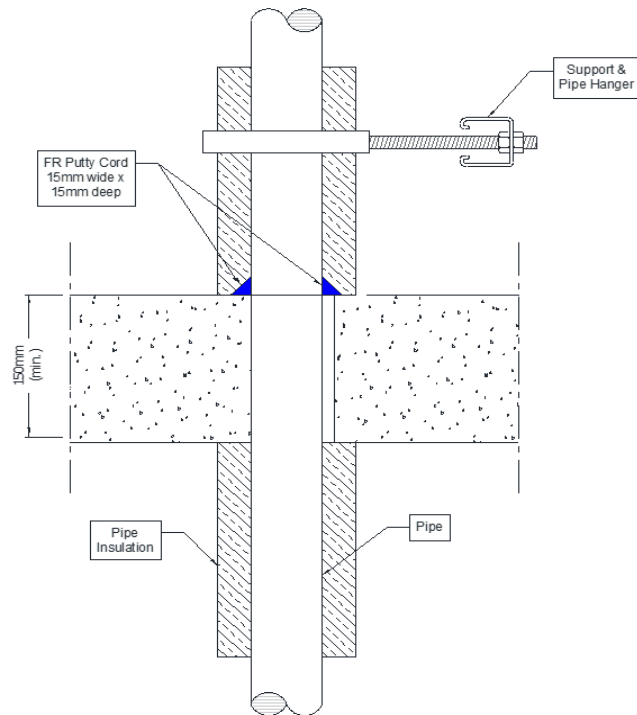

A.4.7.1 Single sided penetration seal with partially insulated metallic pipes

Services	Insulation	Classification
Mild or stainless steel pipe, with minimum 80 kg/m ³ density mineral wool insulation		
Maximum 40 mm diameter*	Minimum 20 mm thick insulation, 500 mm long butted up to each face of the floor	EI 240 C/U
41-324 mm diameter*	Minimum 30 mm thick insulation, 500 mm long butted up to each face of the floor	E 240, EI 60 C/U
ALUPEX pipe with minimum 80 kg/m ³ density mineral wool insulation		
Maximum 16 mm diameter/2.25-8.0 mm wall*	Minimum 20 mm thick insulation, 500 mm long butted up to each face of the floor	EI 240 C/C
Maximum 75 mm diameter/4.6-14.2 mm wall*	Minimum 30 mm thick insulation, 500 mm long butted up to each face of the floor	EI 240 C/C

*See below graphs for interpolation pipe sizes

Steel Pipes with 30 mm Thick Insulation- E 240, EI 60 C/U

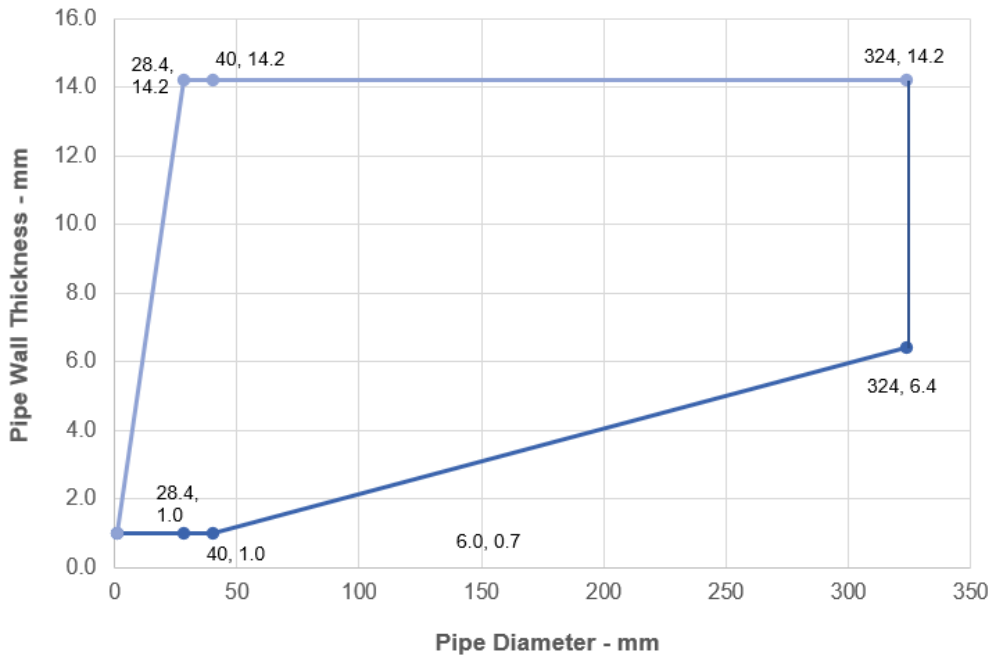

Alupex Pipes with 30 mm Thick Pipe Insulation EI 240 C/C

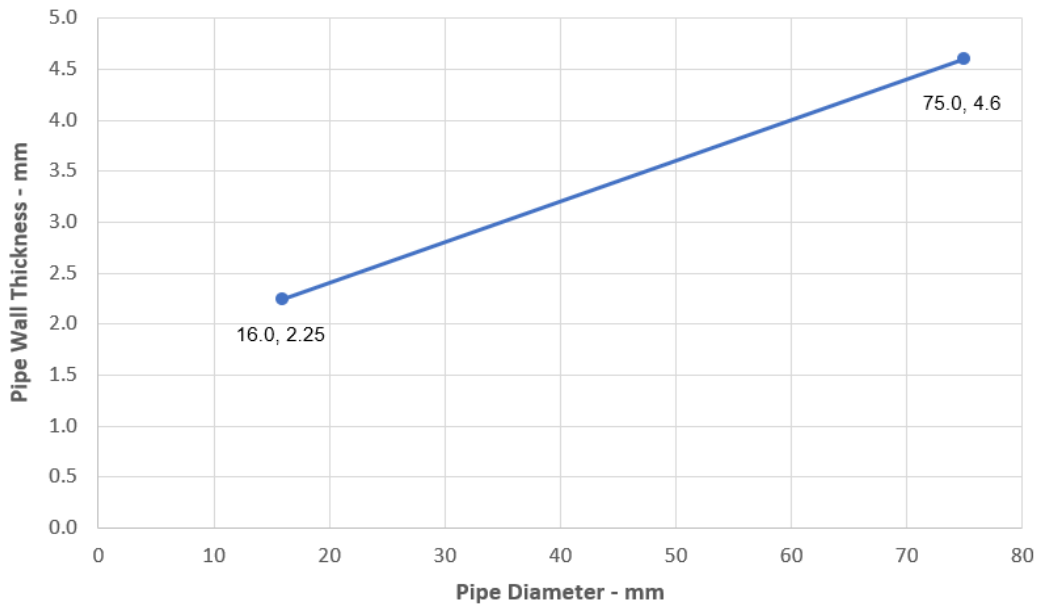

A.4.8 Single sided penetration seal with insulated metallic pipes, Local Interrupted (LI)

Penetration Seal: Metallic pipes insulated with minimum 75 kg/m³ density glass or mineral wool insulation, Local Interrupted (LI), penetrating through a rigid floor construction, fitted at any position within the aperture, sealed with a 15 mm diameter cord of Protecta FR Putty on the top face of the floor. Maximum annular space 10 mm (A1) and minimum separation between penetration seals 30 mm (A2).

Construction details:

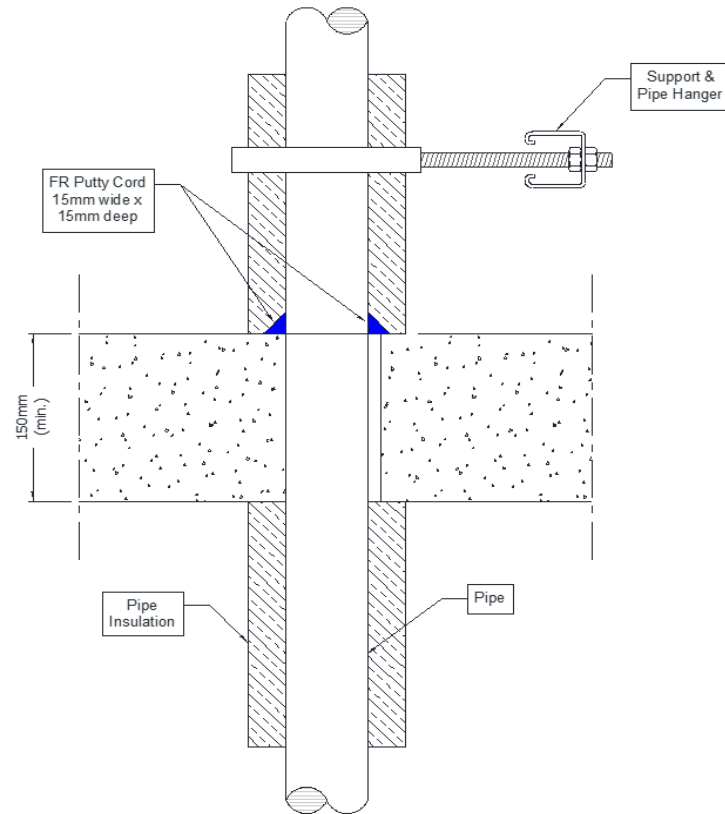

A.4.8.1

Services	Insulation	Classification
Steel pipe with minimum 75 kg/m ³ density glass or mineral wool insulation		
Maximum 40 mm diameter/1.0-14.2 mm wall	Minimum 20 mm thick insulation, 500 mm long butted up to each face of the floor	EI 180 C/U
Copper or steel pipe with minimum 75 kg/m ³ density glass or mineral wool insulation		
Maximum 12 mm diameter/0.7-14.2 mm wall*	Minimum 20 mm thick insulation, 500 mm long butted up to each face of the floor	EI 240 C/C
Maximum 54 mm diameter/1.2-14.2 mm wall*		E 180, EI 120 C/C

*See below graphs for interpolation pipe sizes

Copper Pipes- E 180, EI 120, C/C

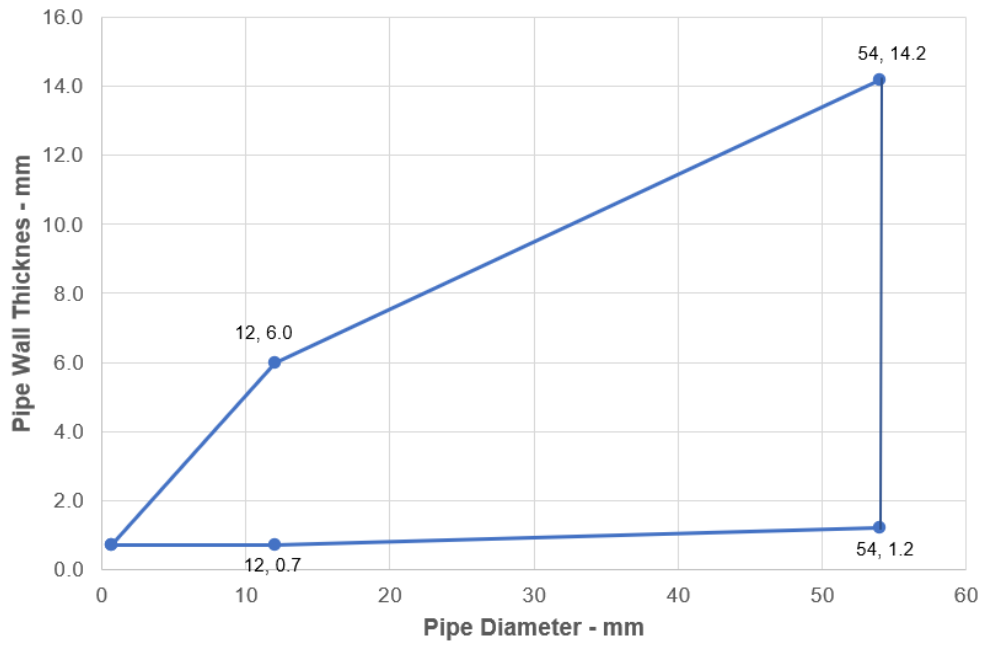

A.4.9 Single sided penetration seal with insulated metallic pipes, Continuous Sustained (CS)

Penetration Seal: Metallic pipes insulated with minimum 80 kg/m³ density mineral wool insulation, Continuous Sustained (CS), penetrating through a rigid floor construction, fitted at any position within the aperture, sealed with a 15mm diameter cord of Protecta FR Putty on the top face of the floor. Maximum annular space 10 mm (A1) and minimum separation between penetration seals 30 mm (A2).

Construction details:

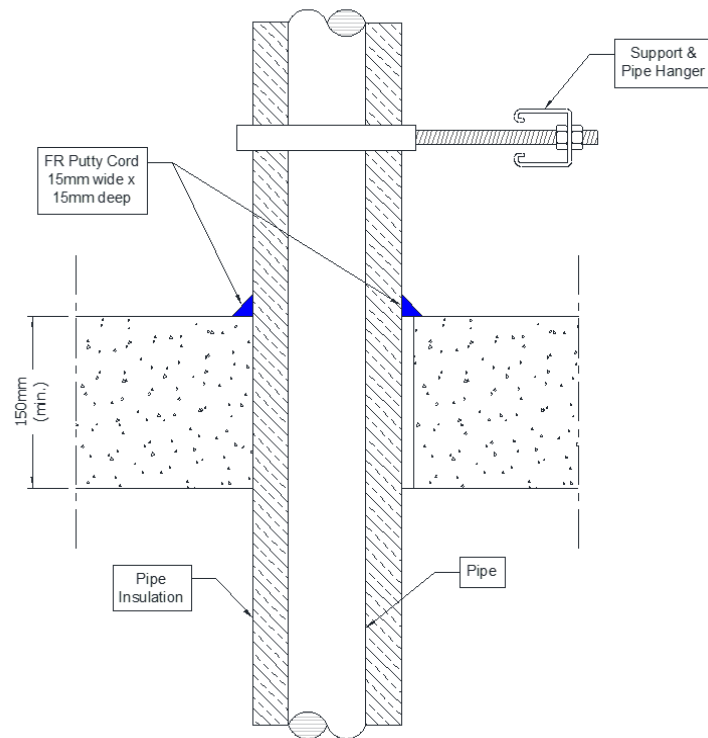

A.4.9.1

Services	Insulation	Classification
Mild or stainless steel pipe, with minimum 80 kg/m ³ density mineral wool insulation		
Maximum 40 mm diameter/1.0-14.2 mm wall	20 mm thick	EI 240 C/U
Maximum 324 mm diameter*	30-80mm thick	EI 240 C/U
Copper or steel pipe with minimum 80 kg/m ³ density mineral wool insulation		
Maximum 12 mm diameter/0.7-6.0 mm wall*	20 mm thick	EI 240 C/C
Maximum 54 mm diameter/1.2-14.2 mm wall*	30-80mm thick	EI 240 C/C
ALUPEX pipe with minimum 80 kg/m ³ density mineral wool insulation		
Maximum 16 mm diameter/2.25-8.0 mm wall*	20 mm thick	EI 240 C/C
Maximum 75 mm diameter/4.6-14.2 mm wall*	30-80mm thick	EI 240 C/C

*See below graphs for interpolation pipe sizes

Steel Pipes with 30-80 mm Thick Insulation - EI 240, C/U

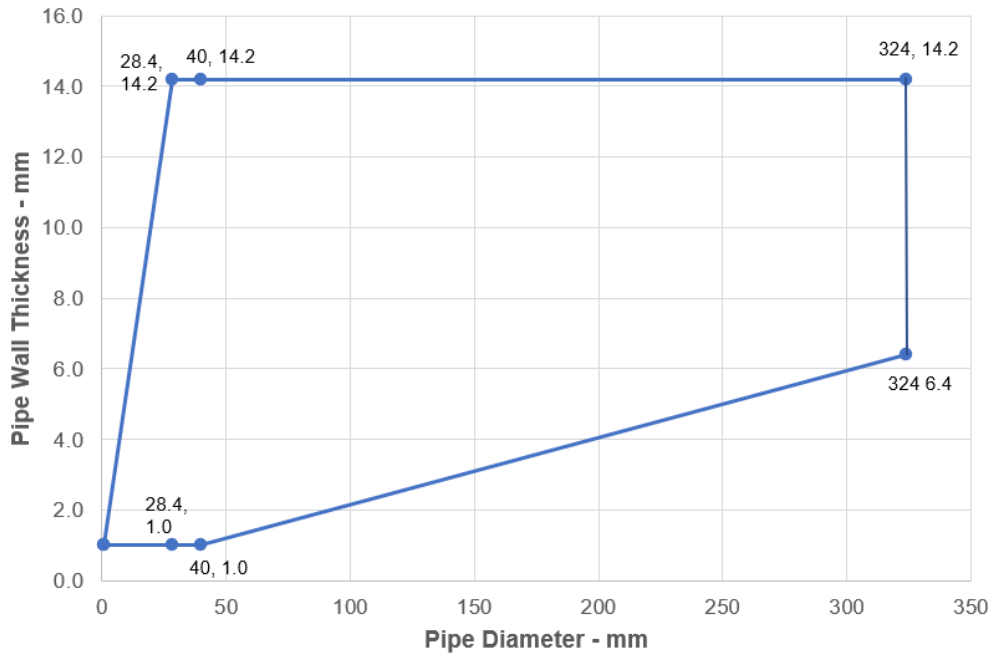

Copper or Steel Pipes with 30-80 mm Thick Insulation - EI 240, C/C

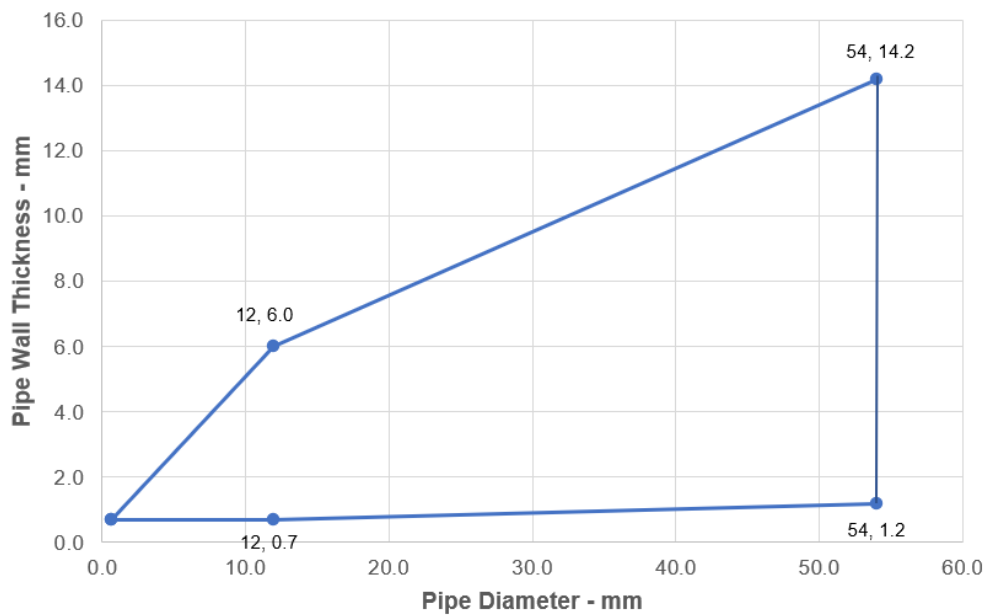

**Alupex Pipes with 30-80 mm Thick Insulation
EI 240 C/C**

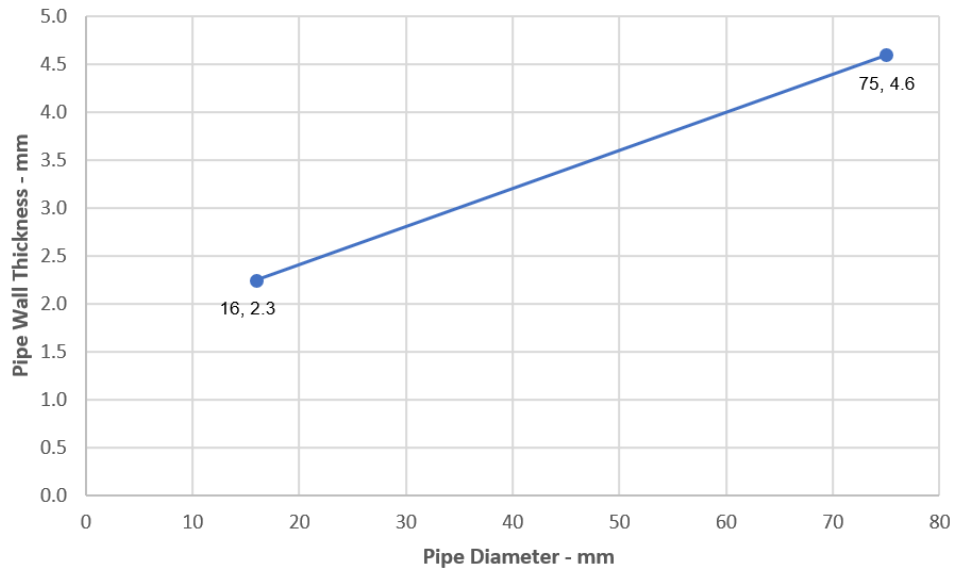

A.4.10 Single sided penetration seal with insulated metallic pipes, Continuous Sustained (CS)

Penetration Seal: Metallic pipes insulated with minimum 75 kg/m³ density glass wool insulation, Continuous Sustained (CS), penetrating through a rigid floor construction, fitted at any position within the aperture, sealed with a 15mm diameter cord of Protecta FR Putty on the top face of the floor. Maximum annular space 10 mm (A1) and minimum separation between penetration seals 30 mm (A2).

Construction details:

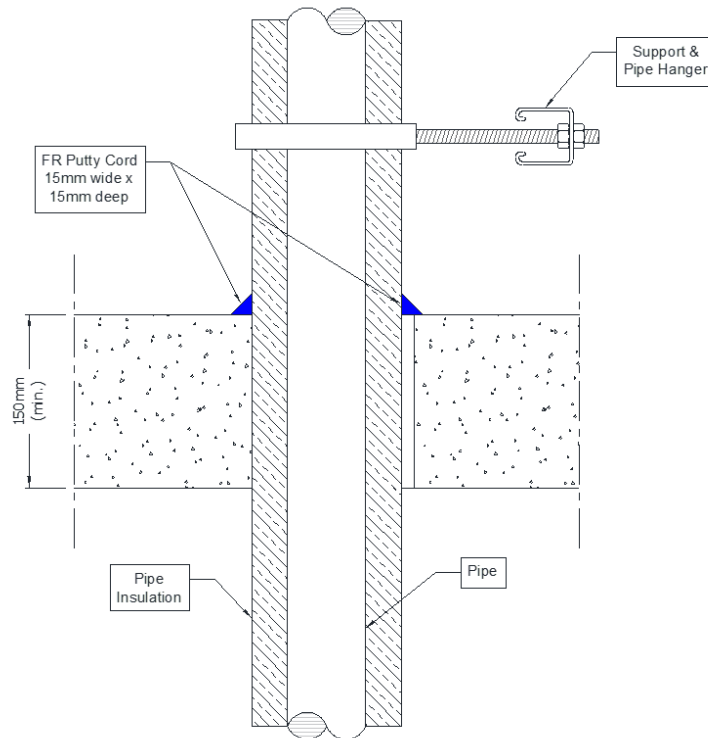

A.4.10.1

Services	Insulation	Classification
Steel pipe with minimum 75 kg/m ³ density glass wool insulation		
Maximum 40 mm diameter/1.0-14.2 mm wall*	20 mm thick	E 180 EI 120 C/U
Copper or steel pipe with minimum 75 kg/m ³ density glass wool insulation		
Maximum 12 mm diameter/0.7-6.0 mm wall*	20 mm thick	E 240, EI 90 C/C
Maximum 54 mm diameter/1.2-14.2 mm wall*	20-40mm thick	EI 90 C/C
ALUPEX pipe with minimum 75 kg/m ³ density glass wool insulation		
Maximum 16 mm diameter/2.25-8.0 mm wall*	20 mm thick	EI 120 C/C
Maximum 75 mm diameter/4.6-14.2 mm wall*	20-50mm thick	EI 120 C/C

*See below graphs for interpolation pipe sizes

Copper or Steel Pipes - EI 90, C/C

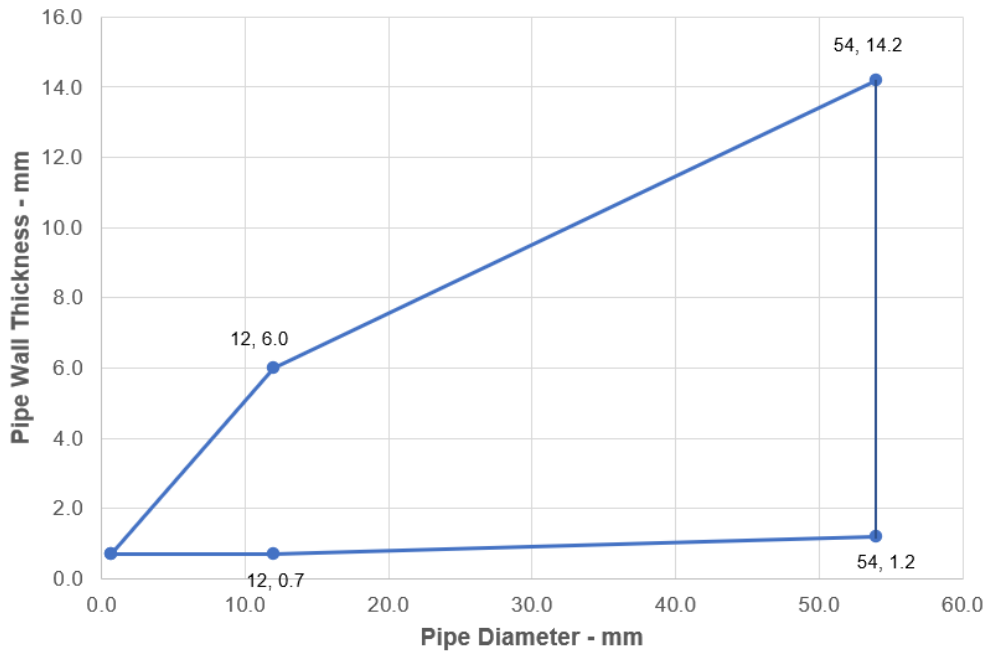

Alupex Pipes - EI 120 C/C

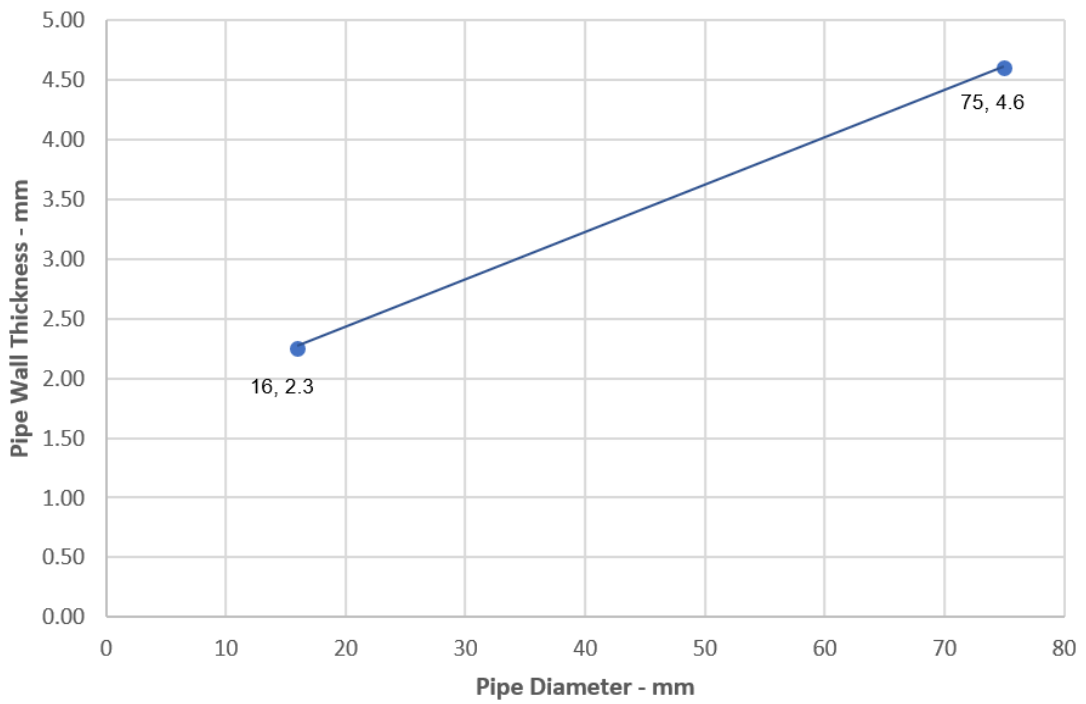

ANNEX B – Air Permeability – Protecta FR Putty

Product tested	Protecta FR Putty Cord around 48mm electrical cable in 58mm hole		
	Summary of testing procedure		Result
	Pressure (Pa)	Leakage (m ³ /h)	Leakage (m ³ /m ² /h)
Results under negative chamber pressure	25	0.32	N/A
	50	0.60	N/A
	100	1.00	N/A
	200	1.63	N/A
	300	2.26	N/A
	600	2.64	N/A
	1000	3.25	N/A
Results under positive chamber pressure	25	0.24	N/A
	50	0.26	N/A
	100	0.36	N/A
	200	0.56	N/A
	300	1.11	N/A
	600	1.88	N/A
	1000	2.49	N/A

