

designated according to Article 29 of the Regulation (EU) No 305/2011 and member of EOTA (European Organisation for Technical Assessment, www.eota.eu)

European Technical Assessment

ETA 22/0733
of 27/04/2023

Technical Assessment Body issuing the ETA and designated according to Article 29 of the Regulation (EU) No 305/2011: UL International (Netherlands) B.V.

Trade name of the construction product	Protecta FR Board
Product family to which the construction product belongs	Fire Stopping and Sealing Product: <ul style="list-style-type: none">• Penetration Seals
Manufacturer	Polyseam Ltd 15. St. Andrews Road Huddersfield, West Yorkshire HD1 6SB, UK www.protecta.co.uk
Manufacturing plant(s)	Polyseam Ltd 15. St. Andrews Road Huddersfield, West Yorkshire HD1 6SB, UK
This European Technical Assessment contains	103 pages including 1 Annex which forms an integral part of this assessment.
This European Technical Assessment is issued in accordance with regulation (EU) No 305/2011, on the basis of	EAD 350454-00-1104, September 2017.

Translations of this European Technical Assessment in other languages shall fully correspond to the original issued document and should be identified as such.

Communication of this European Technical Assessment, including transmission by electronic means, shall be in full. However, partial reproduction may be made, with the written consent of the issuing Technical Assessment Body. Any partial reproduction has to be identified as such.

Table of Contents

I.	SPECIFIC PARTS OF THE EUROPEAN TECHNICAL ASSESSMENT	3
1	Technical description of the product	3
2	Specification of the intended uses of the product in accordance with the applicable European Assessment Document (Hereinafter EAD): EAD 350454-00-1104: 2017	3
3	Performance of the product and references to the methods used for its assessment	6
4	ASSESSMENT AND VERIFICATION OF CONSTANCY OF PERFORMANCE (HEREINAFTER AVCP) SYSTEM APPLIED, WITH REFERENCE TO ITS LEGAL BASE	7
5	Technical details necessary for the implementation of the AVCP system, as provided for in the applicable EAD	7
6	Issued on:	8
ANNEX A – Resistance to Fire Classification – Protecta FR Board	9	
A.1	Rigid wall constructions according to 2. 2)	9
A.1.1	Cable penetration seal with 2x 60 mm thick Protecta FR Board 2-S in minimum 150 mm thick walls	9
A.1.2	Cable penetration seal with 1x 60 mm thick Protecta FR Board 2-S	10
A.1.3	Pipe penetration seal with 2x 60 mm thick Protecta FR Board 2-S	11
A.1.4	Pipe penetration seal with 2x Protecta FR Board 2-S	13
A.1.5	Pipe penetration seal with 1x 60 mm thick Protecta FR Board 2-S	15
A.1.6	Pipe penetration seal with 1x Protecta FR Board 2-S	21
A.1.7	Protecta FR Board 60 mm 2-S penetration seal (protruding) blank and with cables, in rigid wall min. 150 mm thick	25
A.1.8	FR Board 60 mm 2-S penetration seal (pattress) blank and with cables, in rigid wall min. 150 mm thick	26
A.1.9	Penetration seal with 2x Protecta FR Board 2-S	27
A.2	Rigid floor constructions according to 2. 2) with floor thickness of minimum 125 mm	30
A.2.1	Protecta FR Pipe Wrap penetration seal for plastic pipes, in Protecta FR Board	30
A.3	Rigid floor constructions according to 2. 2) with floor thickness of minimum 150 mm	32
A.3.1	Cable penetration seal with 2x Protecta FR Board 2-S	32
A.3.2	Cable penetration seal with 1x Protecta FR Board 2-S	33
A.3.3	Bus-bar penetration seal with 2x Protecta FR Board 1-S (back to back)	34
A.3.4	Pipe penetration seal with 2x Protecta FR Board 2-S	35
A.3.5	Pipe penetration seal with 1x Protecta FR Board 2-S	37
A.3.6	Pipe penetration seal with 1x Protecta FR Board 2-S	40
A.3.7	Pipe penetration seal with 1x Protecta FR Board 2-S	41
A.3.8	Pipe penetration seal with 2x Protecta FR Board 2-S	42
A.3.9	Pipe penetration seal with 2x Protecta FR Board 2-S (back to back)	43
A.4	Timber floor constructions according to 2. 2) with floor thickness of minimum 150 mm	45
A.4.1	Cable penetration seal with 2x Protecta FR Board 1-S	45
A.4.2	Pipe penetration seal with 2x Protecta FR Board 1-S	46
A.5	Flexible or rigid wall constructions according to 2. 2) with wall thickness of minimum 75 mm	49
A.5.1	Cable penetration seal with 2x Protecta FR Board 30 1-S	49
A.5.2	Cable penetration seal with 2x Protecta FR Board 1-S	51
A.6	Flexible or rigid wall constructions according to 2. 2) with wall thickness of minimum 100 mm	52
A.6.1	Cable penetration seal with 2x Protecta FR Board 1-S	52
A.6.2	Pipe penetration seal with 2x Protecta FR Board 1-S	53
A.6.3	Pipe penetration seal with 2x Protecta FR Board 1-S	59
A.6.4	Pipe penetration seal with 2x Protecta FR Board 1-S	61
A.6.5	Pipe penetration seal with 2x Protecta FR Board 1-S	63
A.6.6	Pipe penetration seal with 2x Protecta FR Board 1-S	68
A.6.7	Protecta FR Pipe Wrap penetration seal for plastic pipes, in 2x Protecta FR Board 1-S, in flexible or rigid walls	74
A.6.8	Protecta FR Service Coat FR1 penetration seal for steel pipes, in 2x Protecta FR Board 1-S, in flexible or rigid walls	82
A.6.9	Protecta FR Graphite penetration seal for pipes, in 2x Protecta FR Board 1-S, in flexible or rigid walls	84
A.6.10	Penetration seal with 1x Protecta FR Board 50 2-S in framed aperture	86
A.7	Flexible or rigid wall constructions according to 2. 2) with wall thickness of minimum 120 mm	96
A.7.1	Plastic pipe penetration seal with 2x Protecta FR Board 2-S	96
A.7.2	Metallic pipe penetration seal with 2x Protecta FR Board 1-S	99
A.8	Timber wall constructions according to 2. 2) with wall thickness of minimum 100 mm	102
A.8.1	FR Board 50 mm 1-S penetration seal (pattress) with cables	102
ANNEX B – Air Permeability – Protecta FR Board	103	

I. SPECIFIC PARTS OF THE EUROPEAN TECHNICAL ASSESSMENT

1 Technical description of the product

- 1) Protecta FR Board is a coated mineral wool board used to reinstate the fire resistance performance of wall and floor constructions where they have been provided with apertures for the penetration of single or multiple services.
- 2) The Protecta FR Board is supplied coated on one face, referenced 1-S, or on both faces, referenced 2-S. The board or boards are then cut to allow the penetration of the required services, before being inserted into the aperture in the wall.
- 3) Protecta FR Pipe Wraps, Protecta FR Graphite and Protecta Service Coat FR-1 are required to be used in conjunction with Protecta FR Board depending upon the required application and classification (see Annex A). Protecta FR Pipe Wraps, FR Graphite and Service Coat FR-1 are the subject of separate ETA's.
- 4) Cut the required board(s) to suit the aperture dimensions and type and size of service penetration(s) (see Annex A). All exposed and cut edges of the board can be sealed with Protecta FR Coating or Protecta FR Acrylic prior to fitting which will act as an adhesive (optional). The board(s) must be friction fitted into the aperture with a tight fit (unless gasket fitted). All joints, gaps or imperfections in the installed seal must be filled with Protecta FR Acrylic on the coated exposed side(s) of the board(s). Visible edges of Protecta FR Pipe Wraps can be sealed with Protecta FR Acrylic (optional).
- 5) Polyseam Ltd submitted a written declaration that Protecta FR Board does not contain substances which have to be classified as dangerous according to Directive 67/548/EEC and Regulation (EC) No 1272/2008 and listed in the "Indicative list on dangerous substances" of the EGDS - taking into account the installation conditions of the construction product and the release scenarios resulting from there.

In addition to the specific clauses relating to dangerous substances contained in this European technical Assessment, there may be other requirements applicable to the products falling within its scope (e.g. transposed European legislation and national laws, regulations and administrative provisions). In order to meet the provisions of the Construction Products Regulation, these requirements need also to be complied with, when and where they apply.

2 Specification of the intended uses of the product in accordance with the applicable European Assessment Document (Hereinafter EAD): EAD 350454-00-1104: 2017

Detailed information and data is given in Annex A.

- 1) The intended use of Protecta FR Board is to reinstate the fire resistance performance of flexible wall, rigid wall and floor constructions, and timber wall and floor constructions where they are penetrated by various cables, metallic pipes, composite pipes and plastic pipes.
- 2) The specific elements of construction that the system Protecta FR Board may be used to provide a penetration seal in, are as follows:
 - a. Flexible walls: The wall must have a minimum thickness of 75 mm and comprise steel or timber studs* lined on both faces with minimum 1 layer of 12.5 mm thick boards. Apertures are not required to be lined. Flexible wall solutions may also be used in rigid walls, with a minimum density of 350 kg/m³.
 - b. Timber walls: The wall must have a minimum thickness of 100 mm and comprise solid wood or cross-laminated timber.

- c. Rigid walls: The wall must have a minimum thickness of 75 mm and comprise concrete, aerated concrete or masonry, with a minimum density of 650 kg/m³.
- d. Rigid floors: The floor must have a minimum thickness of 125 mm and comprise aerated concrete or concrete with a minimum density of 650 kg/m³.
- e. Timber floors: The floor must have a minimum thickness of 150 mm and comprise solid wood or cross-laminated timber.

* no part of the penetration seal may be closer than 100 mm to a stud, the cavity must be closed between the penetration seal and the stud, and minimum 100 mm of insulation of class A1 or A2 according to EN 13501-1 must be provided within the cavity between the penetration seal and the stud.

The supporting construction must be classified in accordance with EN 13501-2 for the required fire resistance period.

Protecta Fire Protection Systems which involve services penetrating both sides of a flexible wall may also be used in the situation where the services penetrates one side of the wall only and the remaining side of the wall is not penetrated at the same point (i.e. the services continues on the inside of the wall). All fire integrity and thermal insulation ratings for such single-sided penetrations remain the same as for the equivalent double-sided penetration.

- 3) The System Protecta FR Board may be used to provide a penetration seal with cables, conduits, cable trays, bus-bars, metallic pipes, composite pipes and plastic pipes, with and without insulation, with mixed services within the same seal/aperture (for details see Annex A).
- 4) The total amount of cross sections of services (including insulation) should not exceed 60% of the penetration area.
- 5) The system Protecta FR Board may be used to seal apertures in the separating element of unlimited width by 1200mm high in a wall (uninterrupted separating studs will be required at 2400 mm centres or less in flexible walls), or 2400mm high by 1200mm wide in rigid walls, and 2400mm by 1200 mm in a floor. The additional sizes that are permitted in floors are:

Where 2400 x 1200 mm is specified in Annex A

Width (mm)	Length (mm)
1200	12000
≤ 800	∞ (infinite)

Where 1200 x 600 mm is specified in Annex A

Width (mm)	Length (mm)
600	6000
≤ 400	∞ (infinite)

The minimum permitted separation between adjacent seals/apertures is 100 mm. Services should be a minimum of 25mm from seal edges. Services within the system Protecta FR Board seal do not require a minimum separation, except pipes where combustible pipe insulation penetrates the seal and plastic pipe penetrations which should be a minimum of 30 mm from other services in the aperture (there are exceptions in Annex A).

- 6) Services in floors shall be supported at maximum 450 mm from the top face. Services in walls shall be supported at maximum 270mm from both faces of the wall.

- 7) Where PVC pipes are mentioned in Annex A, this includes PVC-U, PVC-C and similar if the pipe is according to EN 1329-1, EN 1452-2, EN 1453-1[^] and EN 1566-1. Where PP pipes are mentioned in Annex A, this includes PP-MV, PP-H, PP-R and similar if the pipe is according to EN 1451-1 or DIN 8077/8078. Where PE pipes are mentioned, this includes PE-LD, PE-MD, PE-HD, PE-X and similar according to EN 1519-1, EN 12201-2 or EN 12666-1, ABS according to EN 1455-1 and pipes made from SAN+PVC according to EN 1565-1.
- 8) A pattress system is boards installed on the surface of a wall instead of inside the aperture which can be used in Annex A as an alternative installation method, limited to EI 120. The aperture can be located within the wall with maximum size 1100 x 1100 mm or towards the soffit with maximum size 550 mm high x 1100 mm wide. The boards must be oversailing the aperture by 50 mm on both sides of the wall, bonded to the wall with FR Coating and fixed with $\geq 5 \times 100$ mm single thread wood, masonry or concrete screws and penny washers of steel at 300 mm centres. Exposed board edges must be coated with Protecta FR Coating. Soffit applications can be fixed on three sides.
- 9) Solutions in Annex A for 100 mm thick flexible walls, can be used in timber walls (see 2.2) if installed as a pattress system on the surface of a wall instead of inside the aperture. The aperture can be maximum 600mm high x 1200mm wide. The boards must be oversailing the aperture by 100 mm on both sides of the wall, fixed to the wall with ≥ 100 mm wood screws and penny washers of steel at 300 mm centres. The gap between board and wall must have a bead of Protecta FR Acrylic. Exposed board edges must be coated with Protecta FR Coating.
- 10) Solutions in Annex A for 100 mm thick flexible walls with double layer 50 mm thick boards, can be used in 75 mm thick flexible and rigid walls with a maximum aperture of 1,200mm high x 900mm wide, limited to EI 60 unless specified otherwise in Annex A. The boards must be positioned centrally within the wall, and any exposed mineral fibres must be coated with FR Coating.
- 11) Where single sided top face seals are described in Annex A, these can also be used in composite floors (e.g., concrete filled, steel trapezoidal decking).
- 12) Services through the system Protecta FR Board may be used in all angles between 90° and 45° in all directions, subject to metallic pipes only.
- 13) An aperture with or without penetrating services, fire sealed with the system Protecta FR Board, can include a steel or plastic sleeve casted or friction fitted within rigid constructions. The plastic sleeve should have a maximum wall thickness of 9.5 mm (36.3 mm limited to EI 60).
- 14) The system Protecta FR Board in walls, may be surrounded on two sides, horizontally and vertically, with Protecta FR Flexi Board 1-S, maximum 400 mm wide, comprising a lamel construction with the lamels orientated perpendicular to the face of the wall. The solution is limited to EI 120.
- 15) The provisions made in this European Technical Assessment are based on an assumed working life of the Protecta FR Board of 25 years, provided that the conditions laid down in the manufacturers datasheet and instructions for the packaging/transport/ storage/installation/use/repair are met. The indications given on the working life cannot be interpreted as a guarantee given by the producer but are to be regarded only as a means for choosing the right products in relation to the expected economically reasonable working life of the works.
- 16) Type Y₁: intended for use at temperatures below 0°C with exposure to UV but no exposure to rain. Includes lower classes Y₂, Z₁, Z₂.

3 Performance of the product and references to the methods used for its assessment

Product-type: Coated Board		Intended use: Penetration Seal
Assessment method	Essential characteristic	Product Performance
BWR 2 Safety in case of fire		
EN 13501-1	Reaction to fire	D – s1, d0
EN 13501-2	Resistance to fire	Annex A
BWR 3 Hygiene, health and environment		
EN 1026	Air permeability	Annex B
EAD 350454-00-1104, Annex C	Water permeability	No performance determined
Declaration of manufacturer & EN 16516	Release of dangerous substances	Declaration of manufacturer
BWR 4 Safety in use		
EOTA TR 001:2003	Mechanical resistance and stability	No performance determined
EOTA TR 001:2003	Resistance to impact/movement	Pass
EOTA TR 001:2003	Adhesion	No performance determined
EAD 350454-00-1104, Clause 2.2.9	Durability	Y ₁
BWR 5 Protection against noise		
EN 10140-1,2,4,5/ EN ISO 717-1	Airborne sound insulation	29 (-1;-3) dB ¹ 29 (0;-2) dB ² 52 (-4;-7) dB ³ 53 (-4;-7) dB ⁴
BWR 6 Energy economy and heat retention		
EN 12664, EN 12667, EN 12939, EN ISO 8990, EN ISO 6946, EN ISO 14683, EN ISO 10211, EN ISO 10456	Thermal properties	No performance determined
EN ISO 12572, EN 12086, EN ISO 10456	Water vapour permeability	No performance determined

¹ Single 50mm FR Board 2-S.

² Single 60mm FR Board 2-S

³ Double 50 or 60mm FR Board 1-S or 2-S

⁴ Double 50 or 60mm FR Board 1-S or 2-S with 50mm cavity

4 ASSESSMENT AND VERIFICATION OF CONSTANCY OF PERFORMANCE (HEREINAFTER AVCP) SYSTEM APPLIED, WITH REFERENCE TO ITS LEGAL BASE

According to the decision 1999/454/EC – Commission Decision of date 22nd June 1999 on the procedure for attesting the conformity of construction products pursuant to Article 20(2) of Council Directive 89/106/EEC as regards fire stopping, fire sealing and fire protective products, published in the Official Journal of the European Union (OJEU) L178/52 of 14/07/1999, (see <https://eur-lex.europa.eu/oj/direct-access.html>) of the European Commission¹, as amended, the system(s) of assessment and verification of constancy of performance (see Annex V to Regulation (EU) No 305/2011) given in the following table(s) applies (apply).

Product(s)	Intended use(s)	Level(s) or class(es)	System(s)
Fire stopping and Fire Sealing Products	For fire compartmentation and/or fire protection or fire performance	Any	1

5 Technical details necessary for the implementation of the AVCP system, as provided for in the applicable EAD

Tasks of the manufacturer:

Factory production control

The manufacturer shall exercise permanent internal control of production. All the elements, requirements and provisions adopted by the manufacturer shall be documented in a systematic manner in the form of written policies and procedures, including records of results performed. This production control system shall ensure that the product is in conformity with this European Technical Assessment.

The manufacturer may only use initial / raw / constituent materials stated in the technical documentation of this European Technical Assessment.

The factory production control shall be in accordance with the Control Plan of 7th February 2023 relating to the European Technical Assessment ETA 22/0733 issued on 27/04/2023 which is part of the technical documentation of this European Technical Assessment. The "Control Plan" is laid down in the context of the factory production control system operated by the manufacturer and deposited at UL International (Netherlands) B.V.

The results of factory production control shall be recorded and evaluated in accordance with the provisions of the Control Plan.

¹ Official Journal of the European Communities L178/52 of 14/7/1999

Other tasks of the manufacturer:

Additional information

The manufacturer shall provide a technical data sheet and an installation instruction with the following minimum information:

(a) Technical data sheet:

- Field of application:
- Building elements for which the penetration seal is suitable, type and properties of the building elements like minimum thickness, density, and - in case of lightweight constructions – the construction requirements.
- Limits in size, minimum thickness etc. of the penetration seal
- Construction of the penetration seal including the necessary components and additional products (e.g. backfilling material) with clear indication whether they are generic or specific.
- Services which the penetration seal is suitable, type and properties of the services like material, diameter, thickness etc. in case of pipes including insulation materials; necessary/allowed supports/fixings (e.g. pipe trays)

(b) Installation instruction:

- Steps to be followed
- Procedure in case of retrofitting
- Stipulations on maintenance, repair and replacement

6 Issued on:

27th April 2023

Report by:



D. Yates
Staff Engineer
Built Environment

Verified by:



C. Johnson
Senior Staff Engineer
Built Environment

Validated by:



Erik Teubler
Head of TAB
Built Environment

For and on behalf of UL International (Netherlands) B.V.

ANNEX A – Resistance to Fire Classification – Protecta FR Board

A.1 Rigid wall constructions according to 2. 2)

A.1.1 Cable penetration seal with 2x 60 mm thick Protecta FR Board 2-S in minimum 150 mm thick walls

Penetration Seal: Cables fitted at any position within the aperture, with 60 mm Protecta FR Board 2-S to both sides of the wall.

Construction details:

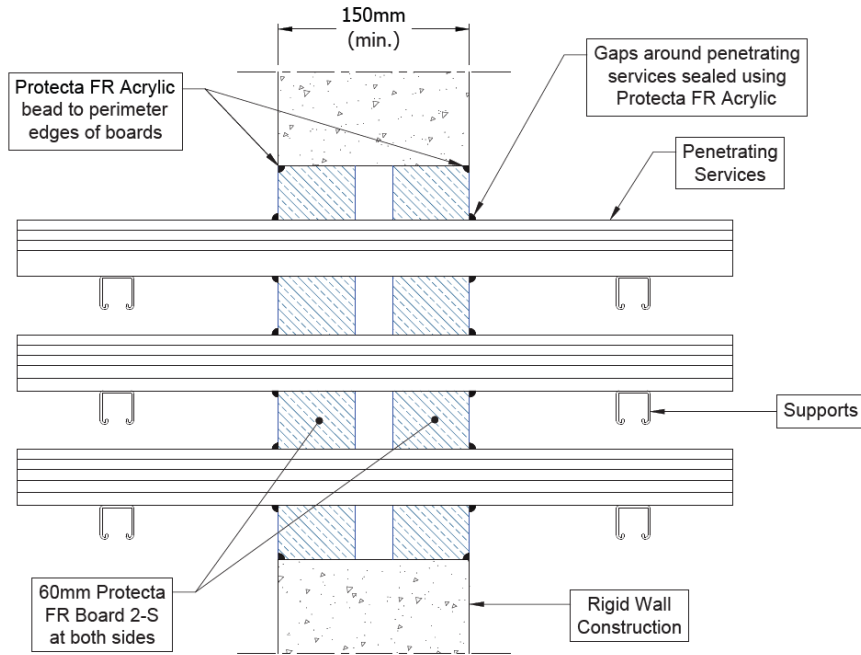

A.1.1.1 Double side penetration seal with cables

Services	Classification
None (blank), at max. 1200 x 1200 mm	EI 240
None (blank)	E 240, EI 180
Single electrical cables up to 21 mm \varnothing	
Single or bundled electrical cables up to 21 mm \varnothing , with or without trays	E 240, EI 180
Electrical cables up to 80 mm \varnothing (single, bundled and on trays)	E 180, EI 60
Cables up to 21mm \varnothing in tied bundles up to 100mm \varnothing	E 180, EI 120
Steel cable trays & ladders	E 180, EI 60
Plastic conduits up to 16 mm \varnothing	EI 180 C/U, EI 180 C/C

A.1.2 Cable penetration seal with 1x 60 mm thick Protecta FR Board 2-S

Penetration Seal: Cables (single) fitted at any position within the aperture, with Protecta FR Board 2-S positioned to either face of the wall (or anywhere in between).

Construction details:

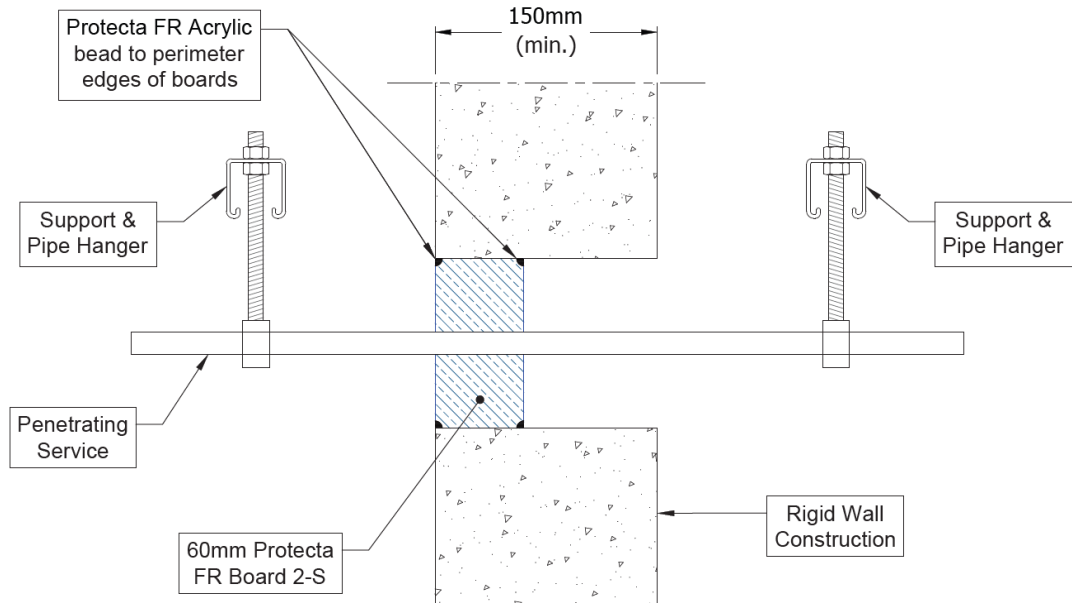

A.1.2.1 Single side penetration seal with cables in minimum 150 mm thick walls

Services	Maximum aperture	Classification
None (blank)	As section 2. 5)	E 240, EI 90
Single electrical cables up to 21 mm \varnothing		
Single A1 cable = 5 x 1.5 mm ² core HD603.3 electrical cable with PVC insulation, PVC sheath and 14 mm diameter	70 x 70 mm	EI 240
Single A2 cable = 5 x 1.5 mm ² core HD22.4 electrical cable with EPR insulation, PO sheath and 11.2-14.4 mm diameter		
Single A3 cable = 5 x 1.5 mm ² core HD604.5 electrical cable with XLPE insulation, EVA sheath and 13 mm diameter		

A.1.2.2 Single side penetration seal with cables in minimum 75 mm thick walls

Services	Maximum aperture	Classification
None (blank)	As section 2. 5)	E 120, EI 90
Single electrical cables up to 21 mm \varnothing		

A.1.3 Pipe penetration seal with 2x 60 mm thick Protecta FR Board 2-S

Penetration Seal: 1000 mm (min.) LI (Local Interrupted) or CI (Continuous Interrupted) insulated metallic pipes (single) fitted at any position within the aperture, with 60 mm Protecta FR Board to both sides of the wall in minimum 150 mm thick walls.

Construction details:

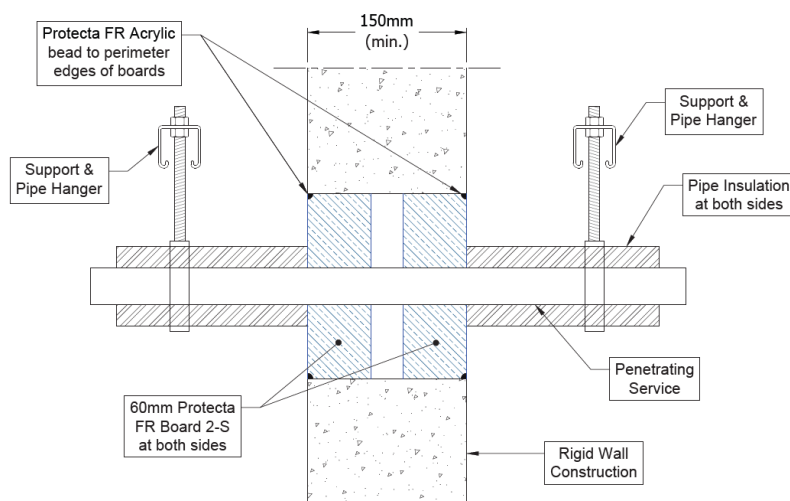

A.1.3.1 Double side penetration seal with pipes

Services	Maximum aperture	Insulation, minimum thickness and density	Classification
Mild or stainless steel pipe			
40 mm diameter/1.5-14.2 mm wall*	1200 x 1200 mm	20 mm Stone wool insulation 80 kg/m ³	EI 240 C/U
40 mm diameter/1.5-14.2 mm wall*	As section 2. 5)	30 mm Stone wool insulation 80 kg/m ³	E 240 C/U, EI 180 C/U
40 mm diameter/1.5-14.2 mm wall*			E 240 C/U, EI 90 C/U
50 mm diameter/1.7-14.2 mm wall*			
60 mm diameter/1.9-14.2 mm wall*			
75 mm diameter/2.2-14.2 mm wall*			
90 mm diameter/2.5-14.2 mm wall*			
100 mm diameter/2.7-14.2 mm wall*			
115 mm diameter/3-14.2 mm wall*			
140 mm diameter/3.5-14.2 mm wall*			
165 mm diameter/ 3.9-14.2 mm wall*			
180 mm diameter/ 4.2-14.2 mm wall*			
200 mm diameter/ 4.6-14.2 mm wall*			
219 mm diameter/ 5.0-14.2 mm wall*			

* Typical pipe diameters shown, see below graph for intermediate sizes

Services	Maximum aperture	Insulation, minimum thickness and density	Classification
Alupex composite			
16 mm diameter/2.25 mm wall	1200 x 1200 mm	20 mm Stone wool insulation 80 kg/m ³	EI 240 U/C
16 mm diameter/2.25 mm wall	As section 2. 5)	20 mm Stone wool insulation 80 kg/m ³	E 240 U/C
			EI 180 U/C
Copper pipe			
Up to 54 mm diameter Copper or steel pipe 0.9-14.2 mm wall	As section 2. 5)	20 mm Stone wool insulation 80 kg/m ³	E 240 C/U, EI 120 C/U

Pipe diameter vs Wall thickness

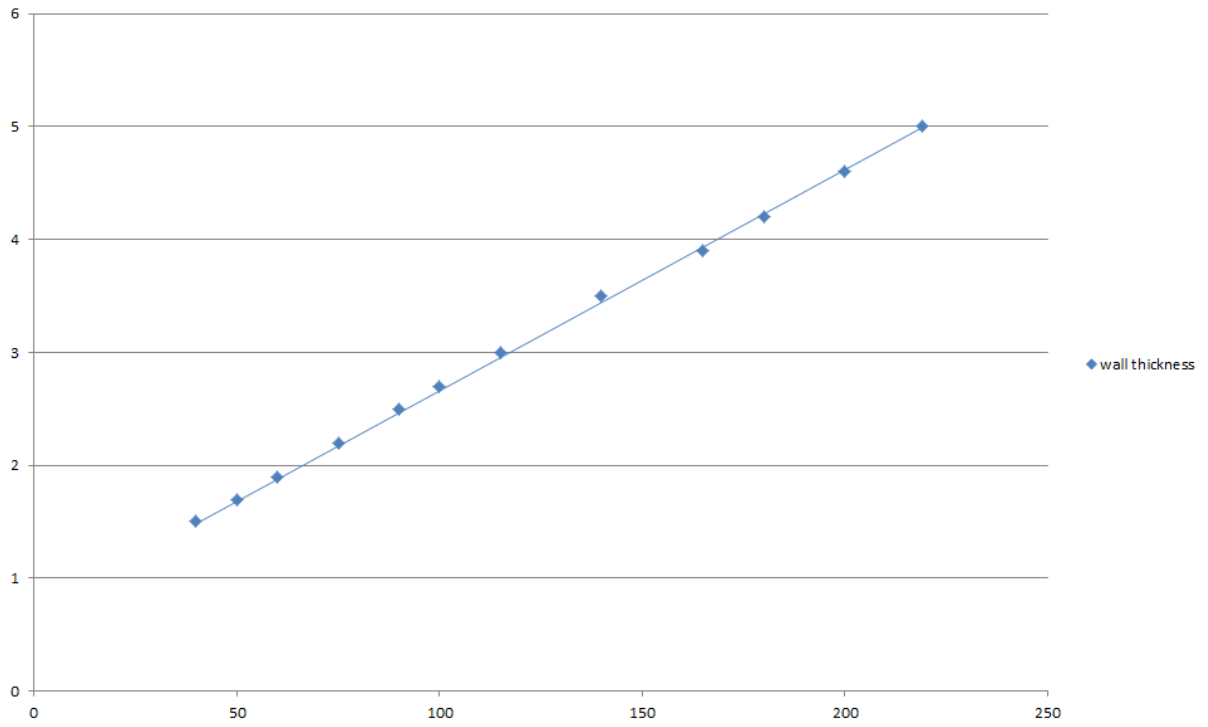

A.1.4 Pipe penetration seal with 2x Protecta FR Board 2-S

Penetration Seal: CS (Continuous Sustained) insulated metallic pipes fitted at any position within the aperture, with 60 mm Protecta FR Board 2-S to both sides of the wall. Minimum separation between penetration seals and seal edges of 30 mm in minimum 150 mm thick walls.

Construction details:

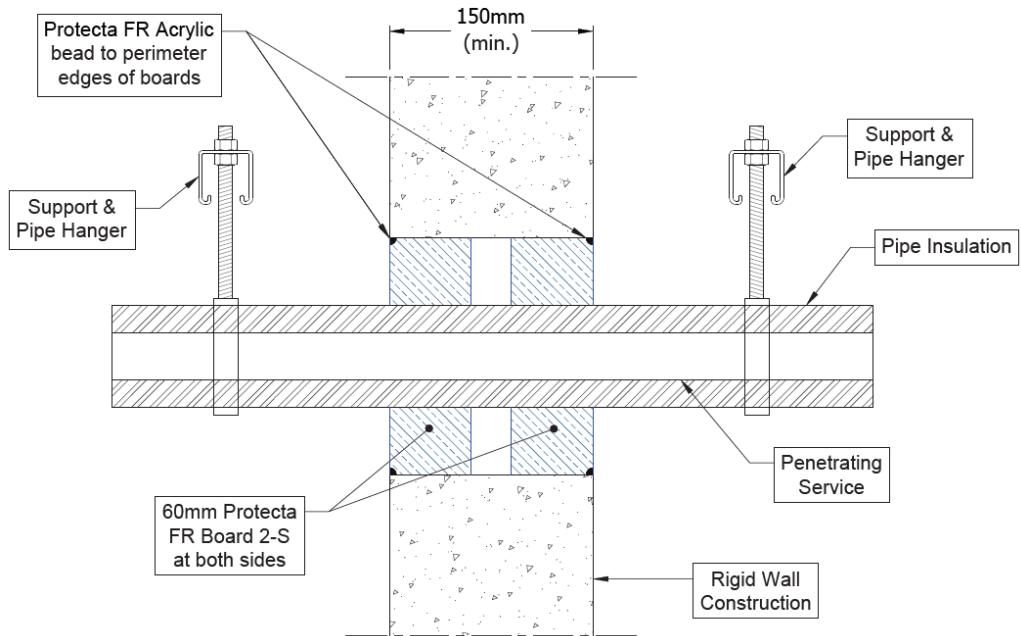

Configuration 1:

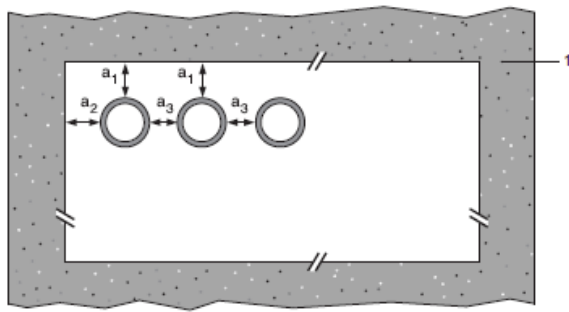

Configuration 2:

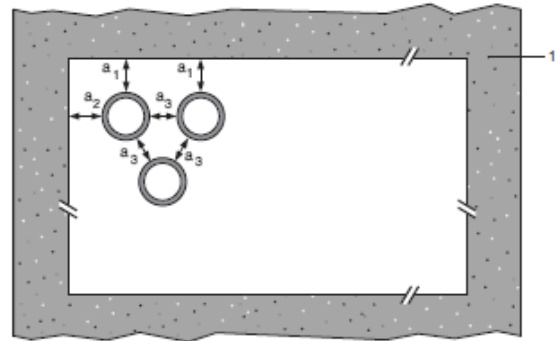

Key

- 1 Supporting construction
- a1 Pipe / top edge of seal separation
- a2 Pipe / side edge of seal separation
- a3 Pipe / pipe separation

A.1.4.1 Double side penetration seal with pipes

Services	Insulation	Classification
Mild or stainless steel pipe		
40 mm diameter/1-14.2 mm wall	20 mm thick stone, mineral wool 80 kg/m ³	E 240 C/U, EI 180 C/U
40 mm diameter/1-14.2 mm wall*	30-80 mm thick stone, mineral wool min. 80 kg/m ³	
50 mm diameter/1.2-14.2 mm wall*		
60 mm diameter/1.4-14.2 mm wall*		
75 mm diameter/1.6-14.2 mm wall*		
90 mm diameter/1.9-14.2 mm wall*		
100 mm diameter/2.1-14.2 mm wall*		
115 mm diameter/2.4-14.2 mm wall*		
140 mm diameter/2.9-14.2 mm wall*		
165 mm diameter/ 3.4-14.2 mm wall*		
180 mm diameter/ 3.6-14.2 mm wall*		
200 mm diameter/ 4.0-14.2 mm wall*		
219 mm diameter/ 4.3-14.2 mm wall*		
250 mm diameter/ 5.0-14.2 mm wall*		
300 mm diameter/ 5.9-14.2 mm wall*		
324 mm diameter/ 6.35-14.2 mm wall*		

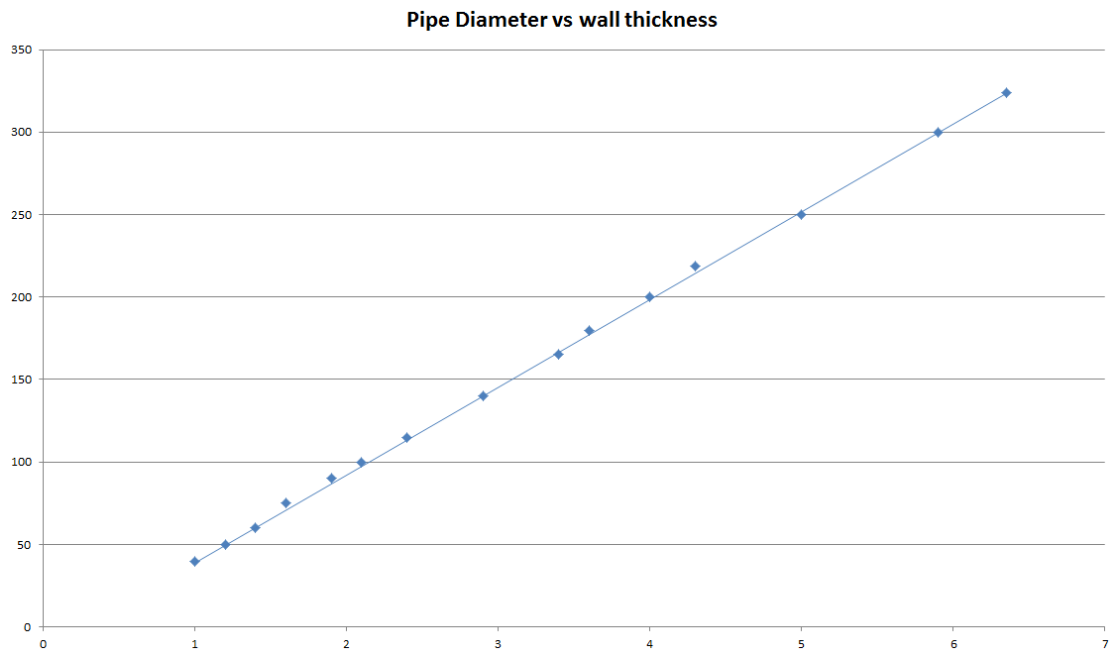

A.1.5 Pipe penetration seal with 1x 60 mm thick Protecta FR Board 2-S

Penetration Seal: 1000 mm (min.)* LI (Local Interrupted), CI (Continuous Interrupted) or CS (continuous sustained) insulated metallic and composite pipes (single) fitted at any position within the aperture, with 60 mm Protecta FR Board to one side of the wall.

Construction details:

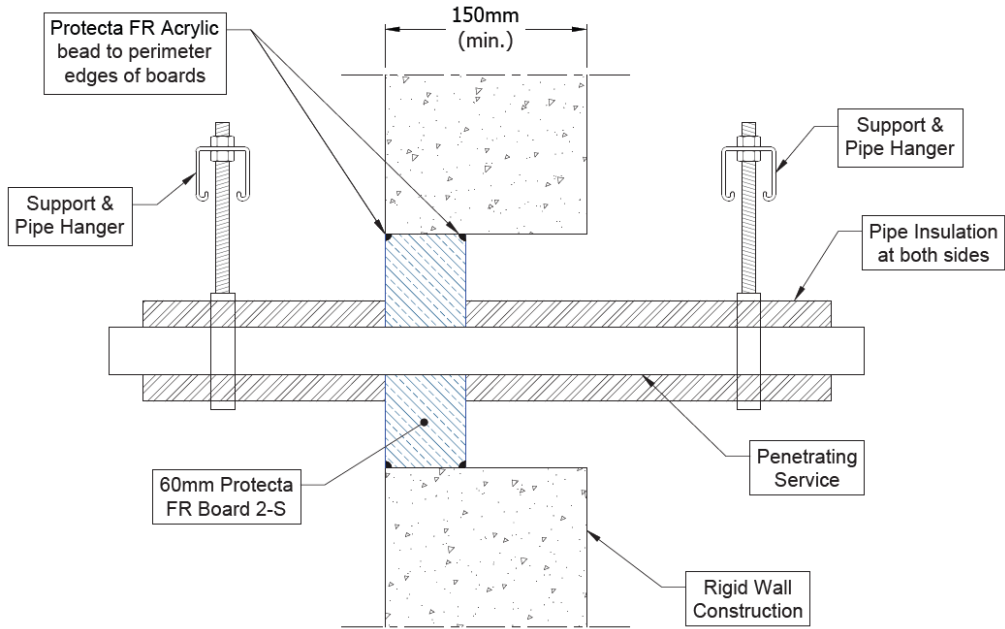

* 600 mm long insulation required for Alupex pipes

A.1.5.1 Single side penetration seal with pipes in minimum 150 mm thick walls

Services	Maximum Aperture	Insulation, minimum thickness and density	Classification
Up to 12 mm diameter Copper or steel pipe 0.9-14.2 mm wall	70 x 70 mm	20 mm Stone wool insulation 80 kg/m ³	EI 240 C/U
Up to 54 mm diameter Copper or steel pipe 0.9-14.2 mm wall	115 x 115 mm		E 240 C/U, EI 120 C/U
75 mm diameter Alupex composite pipe 7.5 mm wall	200 x 200 mm	30 mm Stone wool insulation 80 kg/m ³	EI 120 C/C
Up to 54 mm diameter Copper or steel pipe 0.9-14.2 mm wall	As section 2. 5)	20 mm Stone wool insulation 80 kg/m ³	E 240 C/U, EI 90 C/U
Up to 75 mm diameter Alupex composite pipe 7.5 mm wall		30 mm Stone wool insulation 80 kg/m ³	E 120 C/C, EI 90 C/C
325 mm diameter Steel pipe*		E 120 C/U, EI 90 C/U	

* Typical pipe diameters shown, see below graph for intermediate sizes

Mild or Stainless Steel Pipes - E 120 C/U, EI 90 C/U

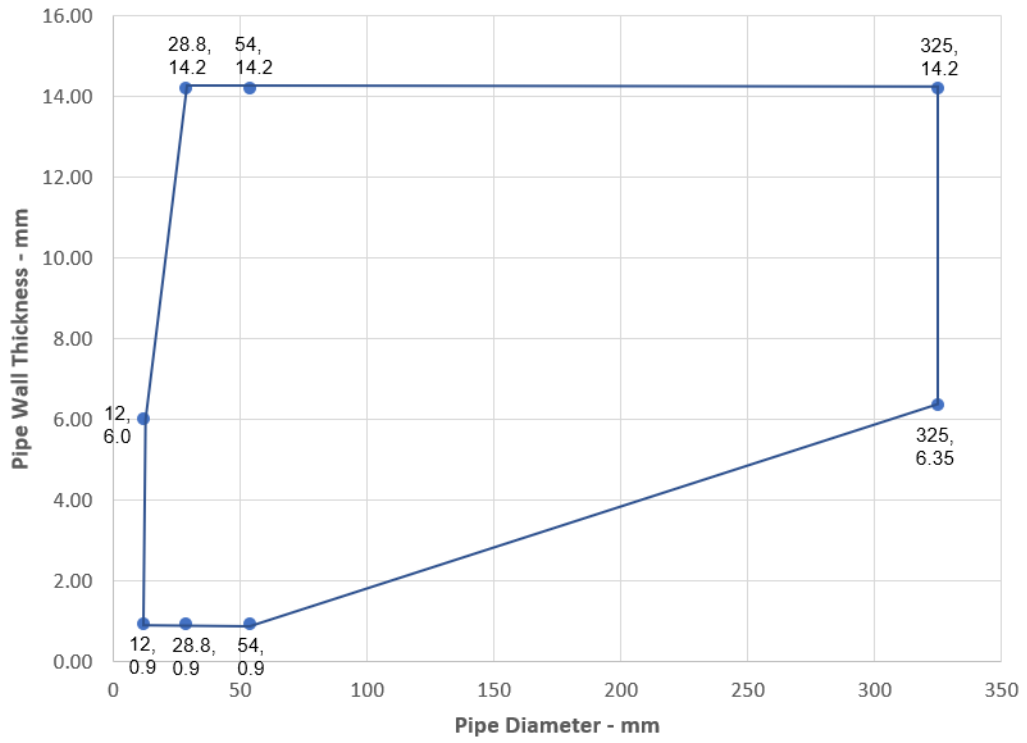

Services	Maximum Aperture	Insulation, minimum thickness and density	Classification
Mild or stainless steel pipe			
40 mm diameter/1.5-14.2 mm wall*	280 x 280 mm	20 mm Stone wool insulation 80 kg/m ³	EI 240 C/U
40 mm diameter/1.5-14.2 mm wall*		30 mm Stone wool insulation 80 kg/m ³	
50 mm diameter/1.7-14.2 mm wall*			
60 mm diameter/1.9-14.2 mm wall*			
75 mm diameter/2.2-14.2 mm wall*			
90 mm diameter/2.5-14.2 mm wall*			
100 mm diameter/2.7-14.2 mm wall*			
115 mm diameter/3-14.2 mm wall*			
140 mm diameter/3.5-14.2 mm wall*			
165 mm diameter/ 3.9-14.2 mm wall*			
180 mm diameter/ 4.2-14.2 mm wall*			
200 mm diameter/ 4.6-14.2 mm wall*			
219 mm diameter/ 5.0-14.2 mm wall*			
40 mm diameter/1.5-14.2 mm wall*	As section 2. 5)	20 mm Stone wool insulation 80 kg/m ³	E 240 C/U, EI 90 C/U
50 mm diameter/1.7-14.2 mm wall*		30 mm Stone wool insulation 80 kg/m ³	
60 mm diameter/1.9-14.2 mm wall*			
75 mm diameter/2.2-14.2 mm wall*			
90 mm diameter/2.5-14.2 mm wall*			
100 mm diameter/2.7-14.2 mm wall*			
115 mm diameter/3-14.2 mm wall*			
140 mm diameter/3.5-14.2 mm wall*			
165 mm diameter/ 3.9-14.2 mm wall*			
180 mm diameter/ 4.2-14.2 mm wall*			
200 mm diameter/ 4.6-14.2 mm wall*			
219 mm diameter/ 5.0-14.2 mm wall*			

* Typical pipe diameters shown, see below graph for intermediate sizes

Pipe diameter vs Wall thickness

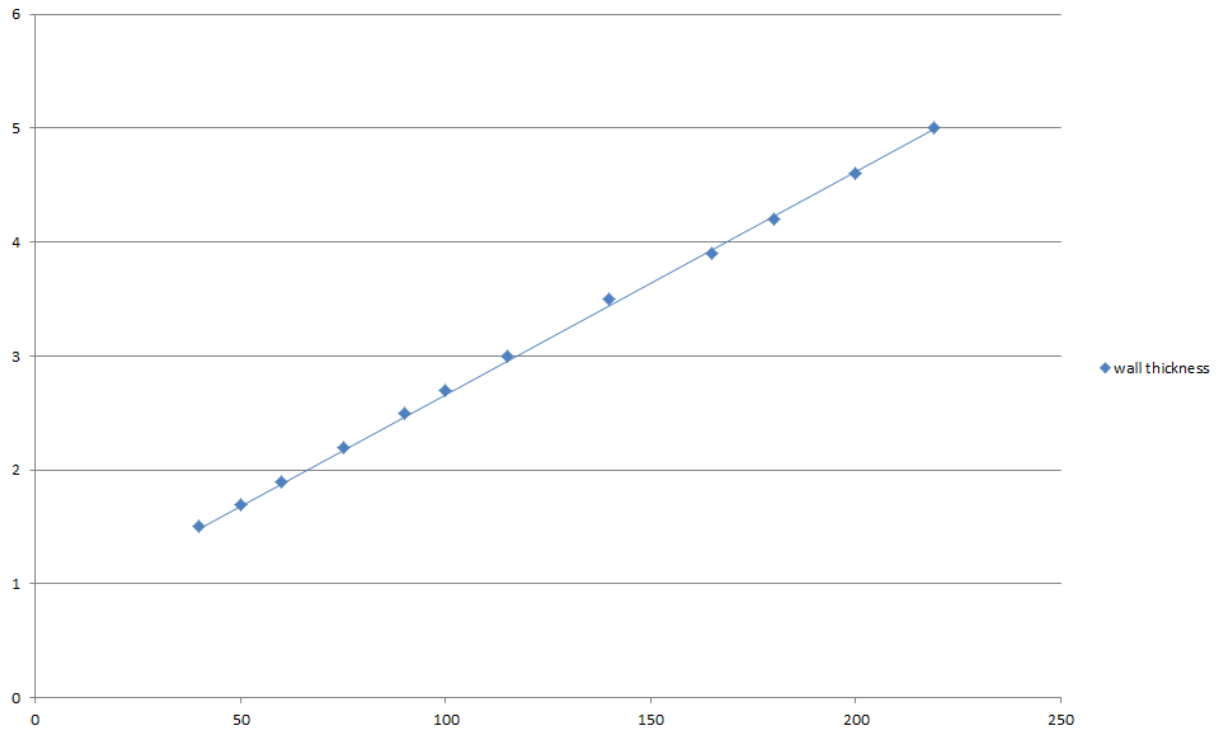

A.1.5.2 Single side penetration seal with pipes in minimum 75 mm thick walls

Services	Maximum Aperture	Insulation, minimum thickness and density	Classification
Up to 54 mm diameter Copper or steel pipe 0.9-14.2 mm wall	As section 2. 5)	20 mm Stone wool insulation 80 kg/m ³	E 120 C/U, EI 90 C/U
Up to 75 mm diameter Alupex composite pipe 7.5 mm wall		30 mm Stone wool insulation 80 kg/m ³	E 120 C/C, EI 90 C/C
325 mm diameter Steel pipe*			E 120 C/U, EI 90 C/U

* Typical pipe diameters shown, see below graph for intermediate sizes

Mild or Stainless Steel Pipes - E 120 C/U, EI 90 C/U

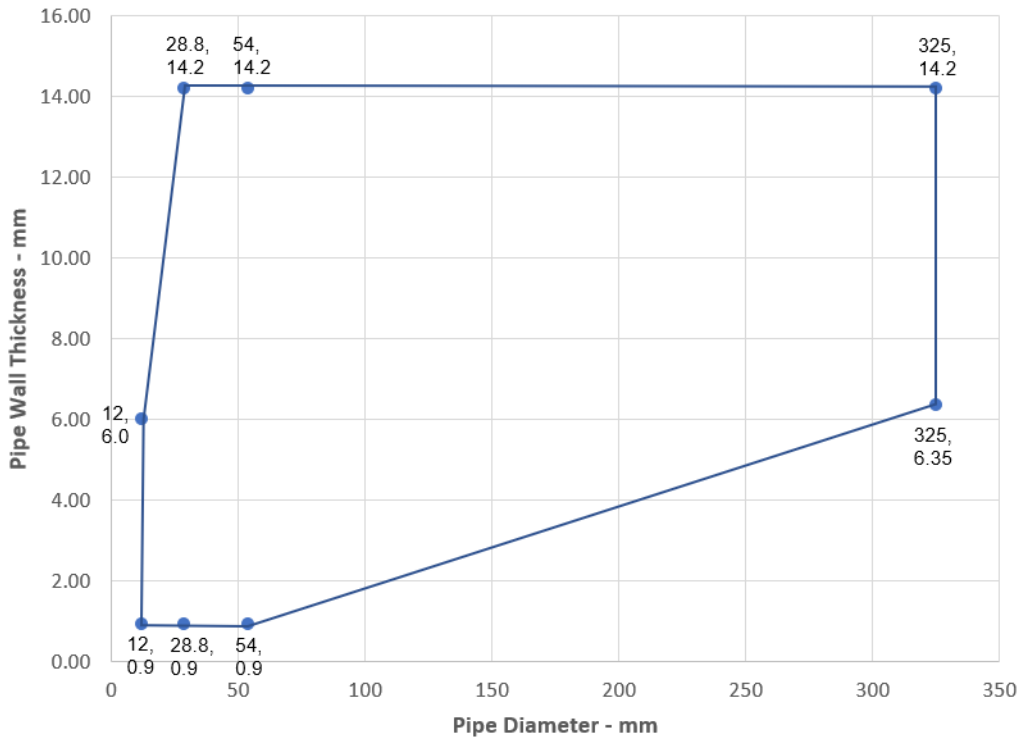

Services	Maximum Aperture	Insulation, minimum thickness and density	Classification
Mild or stainless steel pipe			
40 mm diameter/1.5-14.2 mm wall*	As section 2. 5)	20 mm Stone wool insulation 80 kg/m ³	E 120 C/U, EI 90 C/U
50 mm diameter/1.7-14.2 mm wall*		30 mm Stone wool insulation 80 kg/m ³	
60 mm diameter/1.9-14.2 mm wall*			
75 mm diameter/2.2-14.2 mm wall*			
90 mm diameter/2.5-14.2 mm wall*			
100 mm diameter/2.7-14.2 mm wall*			
115 mm diameter/3-14.2 mm wall*			
140 mm diameter/3.5-14.2 mm wall*			
165 mm diameter/ 3.9-14.2 mm wall*			
180 mm diameter/ 4.2-14.2 mm wall*			
200 mm diameter/ 4.6-14.2 mm wall*			
219 mm diameter/ 5.0-14.2 mm wall*			

* Typical pipe diameters shown, see below graph for intermediate sizes

Pipe diameter vs Wall thickness

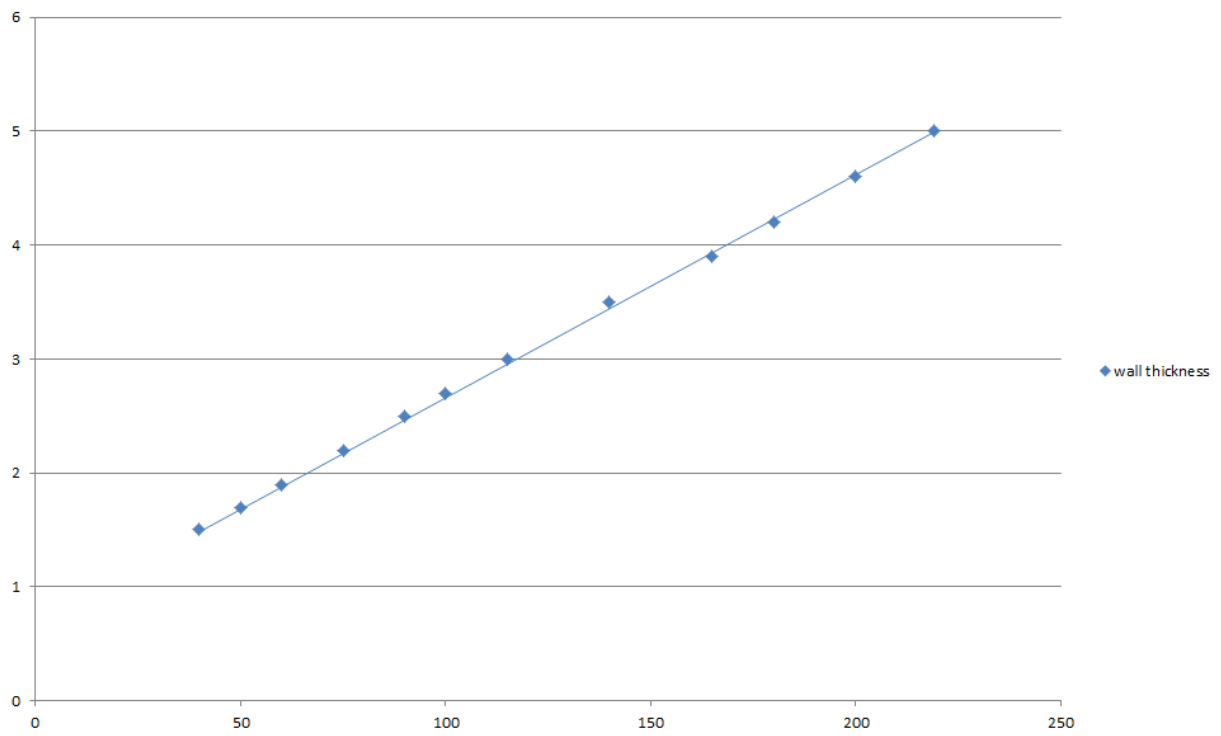

A.1.6 Pipe penetration seal with 1x Protecta FR Board 2-S

Penetration Seal: CS (Continuous Sustained) insulated metallic pipes fitted at any position within the aperture, with 60 mm Protecta FR Board 2-S to either side of the wall (or anywhere in between). Protecta FR Pipes Wraps are required to be fitted around combustible pipe insulation.

Construction details:

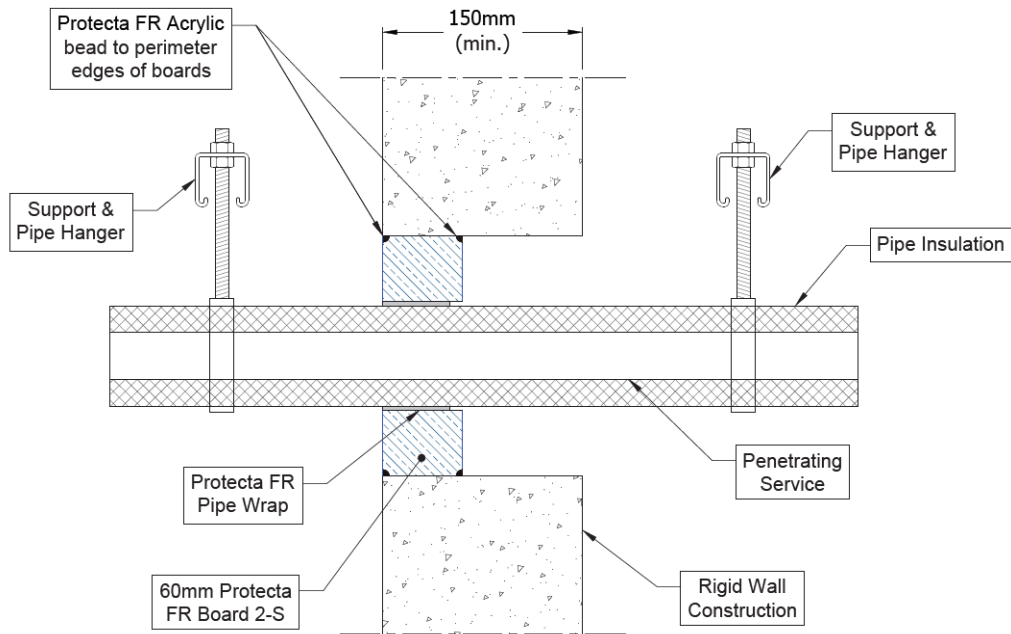

A.1.6.1 Single side penetration seal with pipes in minimum 150 mm thick walls

Services	Wrap	Insulation	Classification
Mild or stainless steel pipe			
165 mm diameter/ 4.5-14.2 mm wall	50 x 1.8 mm Protecta FR Pipe Wrap fitted centrally	9-25 mm elastomeric insulation min. class B-s3, d0	E 120 U/C, E 120 C/U, E 120 C/C, EI 45 U/C, EI 45 C/U, EI 45 C/C
40-219 mm diameter*	Not required	30 mm stone wool min. 80 kg/m ³	E 240 U/C, E 240 C/U, E 240 C/C, EI 60 U/C, EI 60 C/U, EI 60 C/C
40-219 mm diameter*		30-50 mm stone wool min. 80 kg/m ³	E 180 U/C, E 180 C/U, E 180 C/C, EI 60 U/C, EI 60 C/U, EI 60 C/C
40-325 mm diameter*		50 mm stone wool min. 80 kg/m ³	E 180 U/C, E 180 C/U, E 180 C/C, EI 60 U/C, EI 60 C/U, EI 60 C/C

* Typical pipe diameters shown, see below graph for intermediate sizes

Pipe diameter vs Wall thickness

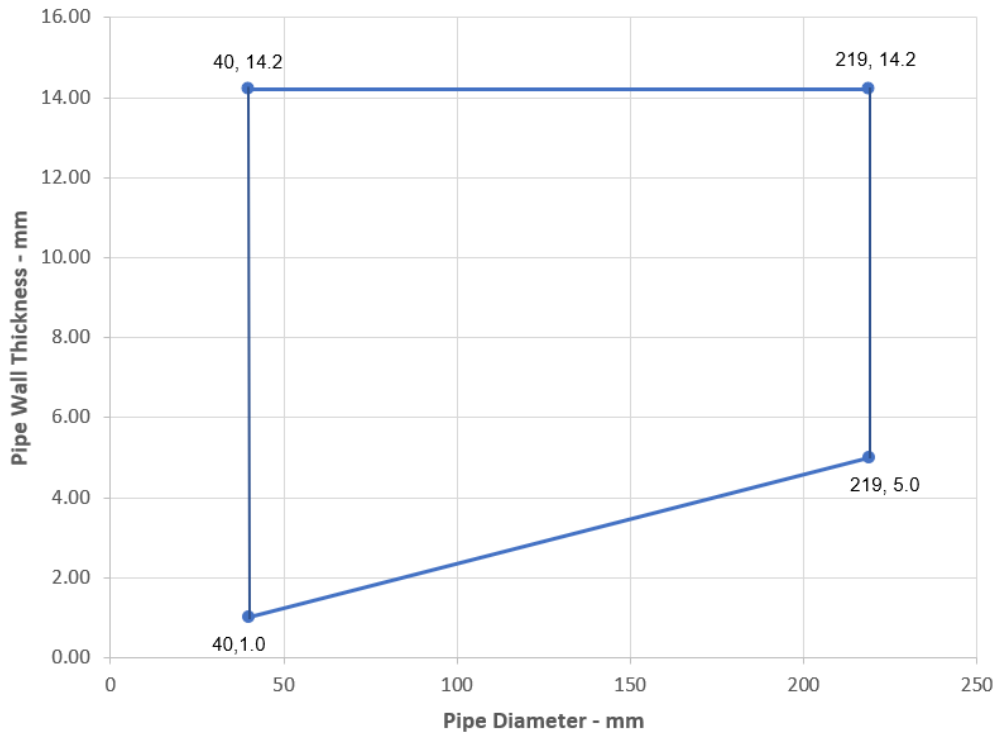

Pipe diameter vs Wall thickness

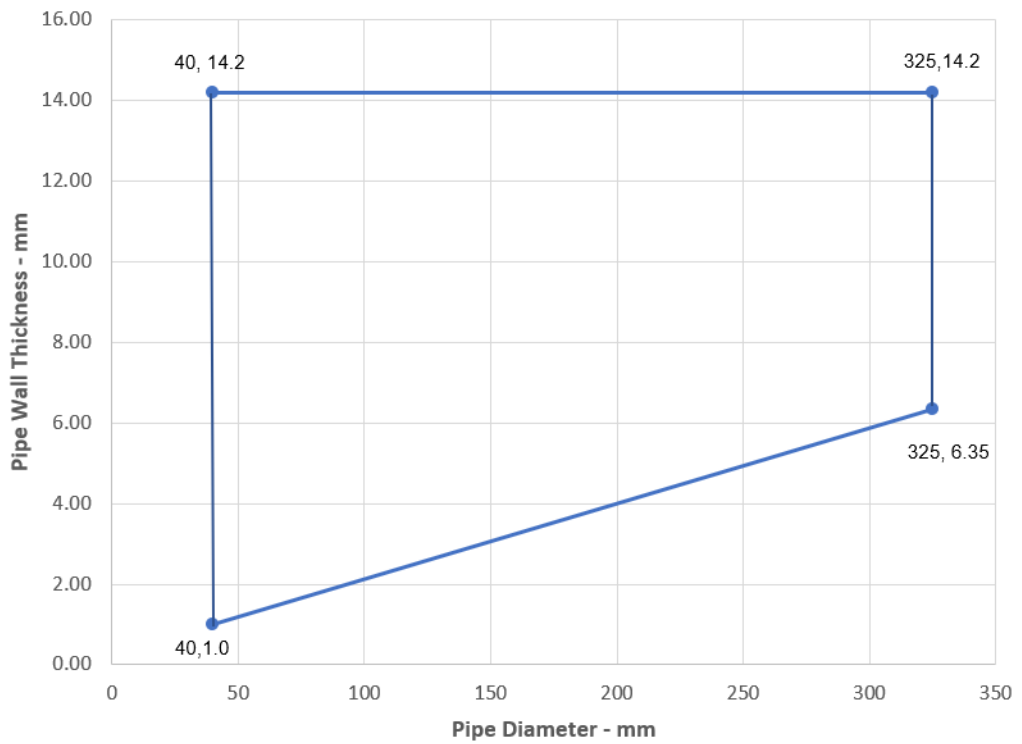

A.1.6.2 Single side penetration seal with pipes in minimum 75 mm thick walls

Single side penetration seal with pipes

Services	Wrap	Insulation	Classification
Mild or stainless steel pipe			
165 mm diameter/ 4.5-14.2 mm wall	50 x 1.8 mm Protecta FR Pipe Wrap fitted centrally	9-25 mm elastomeric insulation min. class B-s3, d0	E 120 U/C, E 120 C/U, E 120 C/C, EI 45 U/C, EI 45 C/U, EI 45 C/C
40-219 mm diameter*	Not required	30-50 mm stone wool min. 80 kg/m ³	E 120 U/C, E 120 C/U, E 120 C/C, EI 60 U/C, EI 60 C/U, EI 60 C/C
40-325 mm diameter*		50 mm stone wool min. 80 kg/m ³	E 120 U/C, E 120 C/U, E 120 C/C, EI 60 U/C, EI 60 C/U, EI 60 C/C

* Typical pipe diameters shown, see below graph for intermediate sizes

Pipe diameter vs Wall thickness

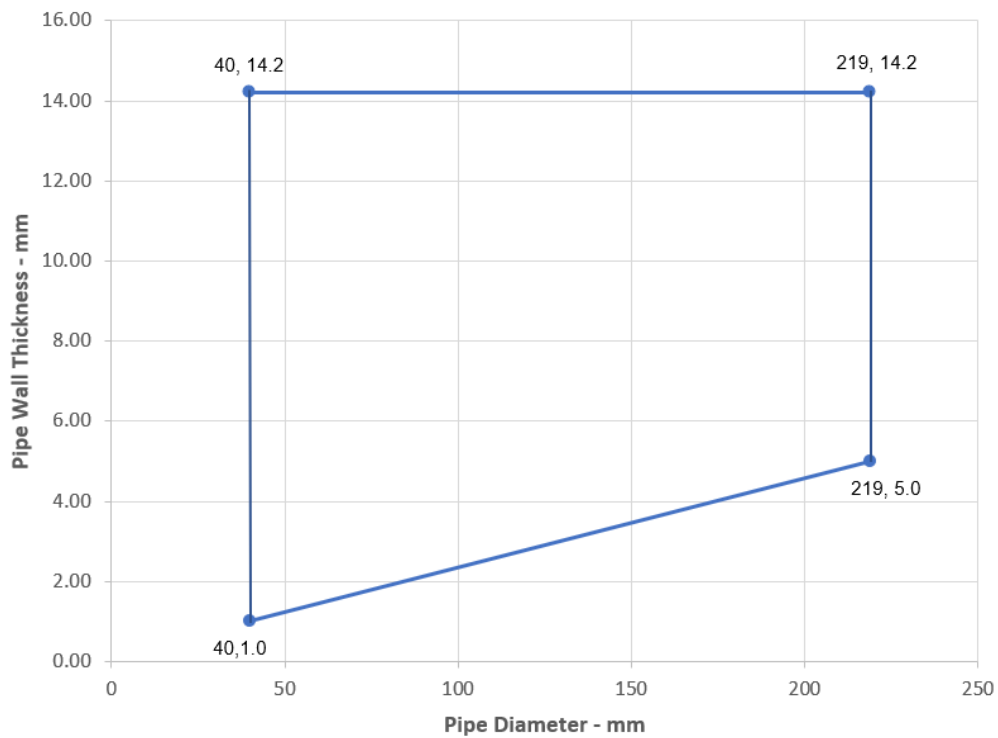

Pipe diameter vs Wall thickness

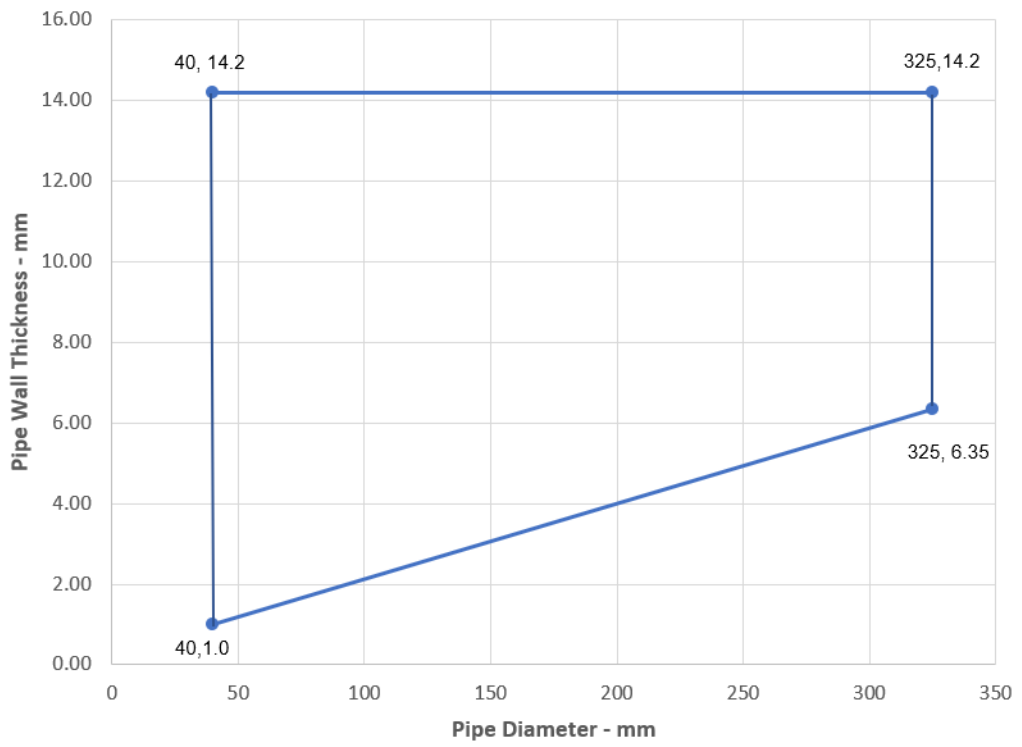

A.1.7 Protecta FR Board 60 mm 2-S penetration seal (protruding) blank and with cables, in rigid wall min. 150 mm thick

Penetration Seal: Cables fitted at any position within the aperture, with 60 mm Protecta FR Board 2-S to both sides of the wall. Boards to be separated by minimum 90 mm.

Construction details:

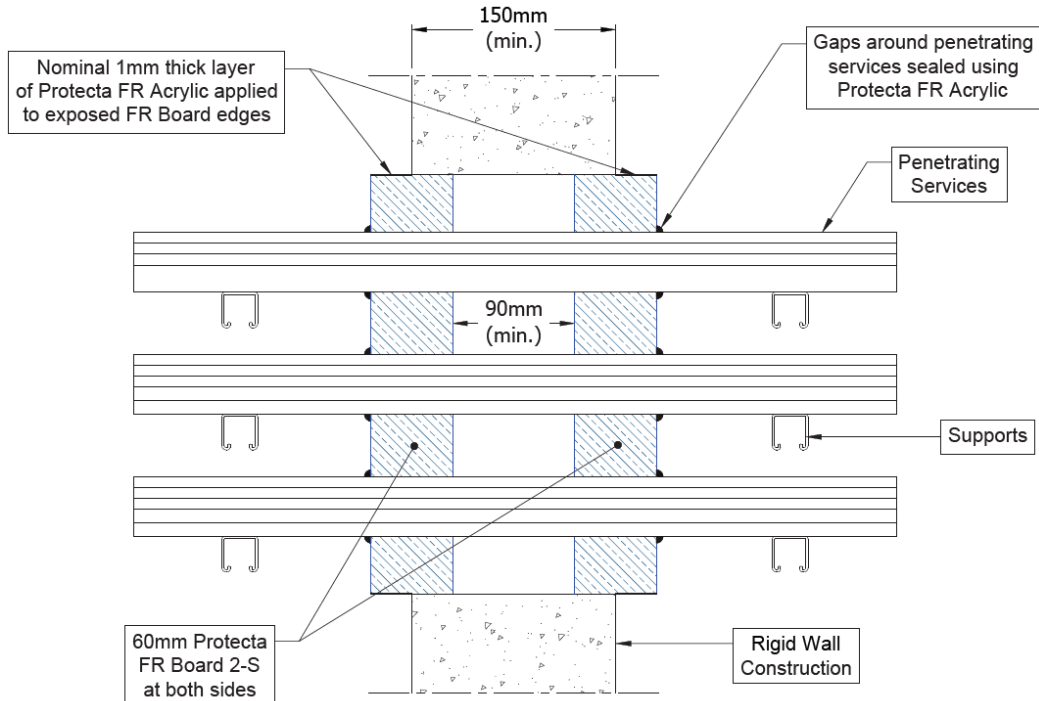

A.1.7.1 Two side penetration seal with cables

Services	Maximum aperture	Classification
None (blank)	600 mm wide x 600 mm high	E 240, EI 180
Single or bundled electrical cables up to 21 mm \varnothing , with or without trays		E 240, EI 120
Electrical cables up to 80 mm \varnothing (single, bundled and on trays)		E 240, EI 60
Cables up to 21mm \varnothing in tied bundles up to 100mm \varnothing		EI 240
Steel cable trays & ladders		E 240, EI 180
Non-Sheathed wires up to 17 mm \varnothing		E 240, EI 180
Non-Sheathed wires up to 24 mm \varnothing		E 240, EI 90

A.1.8 FR Board 60 mm 2-S penetration seal (pattress) blank and with cables, in rigid wall min. 150 mm thick

Penetration Seal: Cables fitted at any position within the aperture, with 60 mm Protecta FR Board 2-S to both sides of the wall. Boards to be pattress fixed with 100 mm steel screws and penny washers at 350 mm centres and with a minimum 50 mm overlap around the opening.

Construction details:

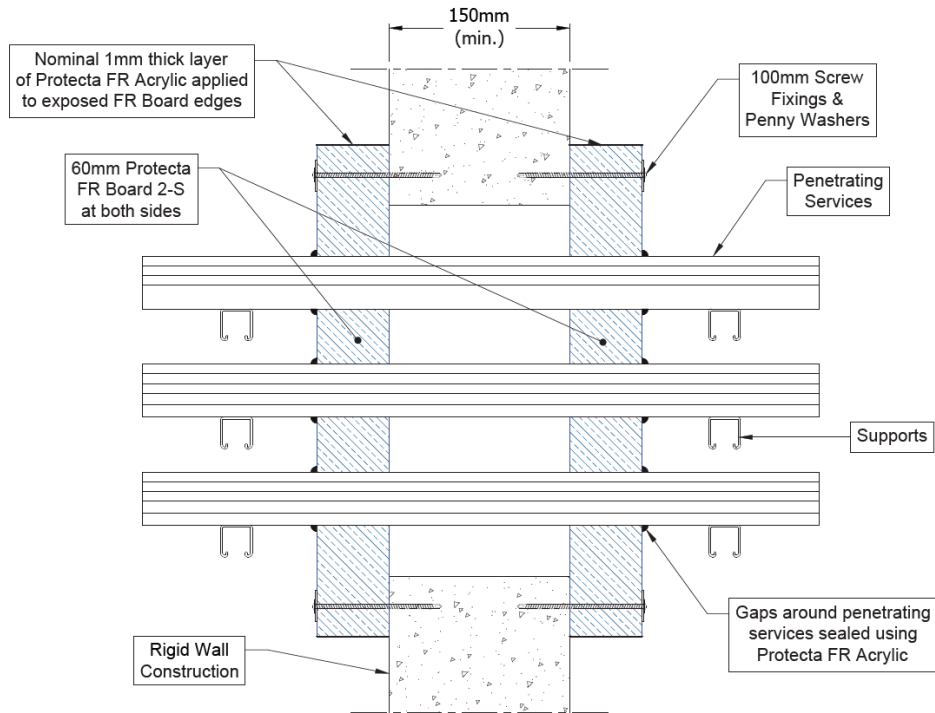

A.1.8.1 Two side penetration seal with cables

Services	Maximum aperture	Classification
None (blank)	600 mm wide x 600 mm high	E 240, EI 180
Single or bundled electrical cables up to 50 mm \varnothing , with or without trays		E 240, EI 90
Single or bundled electrical cables up to 80 mm \varnothing (single, bundled and on trays)		E 240, EI 60
Cables up to 21mm \varnothing in tied bundles up to 100mm \varnothing		EI 240
Steel cable trays & ladders		E 240, EI 180
Non-Sheathed wires up to 24 mm \varnothing		E 240, EI 120

A.1.9 Penetration seal with 2x Protecta FR Board 2-S

Penetration Seal: Plastic and metal pipes fitted at any position within the aperture, with 60 mm Protecta FR Board 2-S to both sides of the wall. Protecta FR Pipes Wraps may be required to be fitted around pipes.

Construction details:

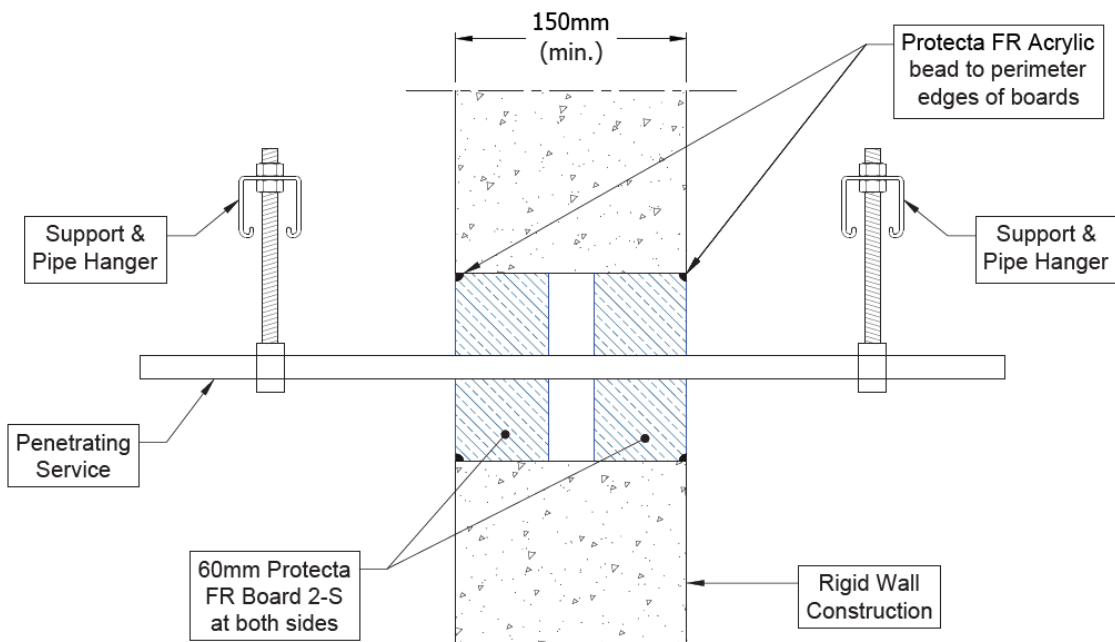
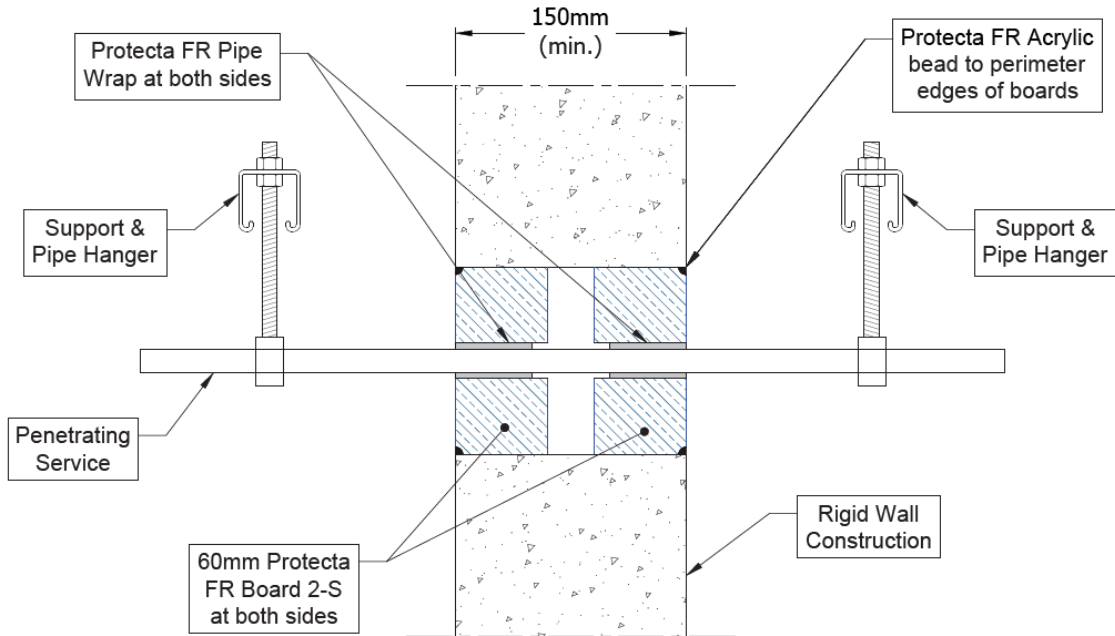

A.1.9.1 Double side penetration seal with pipes

Services	Wrap	Classification
PVC-U pipe according to EN 1329-1, EN 1452-1 and EN 1453-1 and PVC-C according to EN 1566-1		
Up to 32 mm diameter / 1.0-2.4 mm wall [^]	None	EI 240 U/C
Up to 40 mm diameter / 1.9-3.0 mm wall	50 x 1.8 mm	
Up to 110 mm diameter / 2.7-6.6 mm wall	50 x 3.6 mm	
Up to 125 mm diameter / 4.7-7.4 mm wall	50 x 7.2 mm	
Up to 160 mm diameter / 4.0-9.5 mm wall*	50 x 10.8 mm	
Up to 200 mm diameter / 4.9-11.9 mm wall*	75 x 10.8 mm	EI 180 C/C
Up to 315 mm diameter/7.7-12.1 mm wall thickness*#	75 x 18 mm	EI 120 C/C
Up to 400 mm diameter/9.8-15.3 mm wall thickness*#	75 x 28.8 mm	EI 120 C/C
Diameter up to 32 mm \varnothing , wall thickness 1.0-2.4 mm in pipe bundles up to 107 mm \varnothing ¹⁾	50 x 3.6 mm	EI 240 U/C
Diameter up to 110 mm, wall thickness 1.0–6.6 mm, fully or partially filled conduits with cables up to 14 mm diameter	50 x 3.6 mm	EI 120 U/C
PE pipe according to EN 1519-1, EN 12201-2 and EN 12666-1, ABS according to EN 1455-1 and pipes made from SAN+PVC according to EN 1565-1		
Up to 20 mm diameter / 2.0 mm wall	None	EI 120 U/C
Up to 32 mm diameter / 3.0 mm wall	None	
Up to 32 mm diameter / 2.0-3.0 mm wall	None	EI 90 U/C
Up to 40 mm diameter / 2.4-4.6 mm wall	50 x 1.8 mm	EI 240 U/C
Up to 110 mm diameter / 3.4-10.0 mm wall	50 x 3.6 mm	
Up to 125 mm diameter / 3.9-7.4 mm wall	50 x 7.2 mm	
Up to 160 mm diameter / 4.9-9.5 mm wall	50 x 10.8 mm	
Up to 200 mm diameter / 4.9-18.2 mm wall	75 x 10.8 mm	EI 180 C/C
Up to 315 mm diameter / 28.6 mm wall	75 x 18.0 mm	E 180 C/C, EI 120 C/C
Up to 400 mm diameter / 36.3 mm wall	75 x 28.8 mm	EI 120 C/C
Diameter up to 32 mm \varnothing , wall thickness 2.0-4.4 mm in pipe bundles up to 107 mm \varnothing ¹⁾	50 x 3.6 mm	EI 240 C/U
Diameter up to 110 mm, wall thickness 2.0–10.0 mm, fully or partially filled conduits with cables up to 14 mm diameter	50 x 3.6 mm	EI 120 U/C
PP pipe according to EN 1451-1		
Up to 32 mm diameter / 1.9-4.4 mm wall	None	EI 60 U/C
Up to 40 mm diameter / 1.8-5.5 mm wall	50 x 1.8 mm	EI 240 U/C
Up to 110 mm diameter / 2.7-10.0 mm wall	50 x 3.6 mm	EI 240 C/C
Up to 125 mm diameter / 3.1-11.4 mm wall	50 x 7.2 mm	
Up to 160 mm diameter / 4.9-14.6 mm wall	50 x 10.8 mm	
Up to 200 mm diameter / 4.9-18.2 mm wall	75 x 10.8 mm	EI 180 C/C
Diameter up to 32 mm \varnothing , wall thickness 1.8-4.4 mm in pipe bundles up to 107 mm \varnothing ¹⁾	50 x 3.6 mm	EI 240 C/U
Diameter up to 110 mm, wall thickness 1.8–10.0 mm, fully or partially filled conduits with cables up to 14 mm diameter	50 x 3.6 mm	EI 120 U/C
Copper and steel pipe		
Up to 12 mm diameter / 0.6-6.0 mm wall*	None	EI 120 C/U

¹⁾ PVC, PE and PP pipes can be mixed in the same bundle.

* Typical pipe diameters shown, see below graph for intermediate sizes.

Configuration 1 & 2

[^]Sealed with a bead of Protecta FR Acrylic applied flush to the pipe and batt on the outer faces of the board

PVC-U Pipes - EI 120 C/C

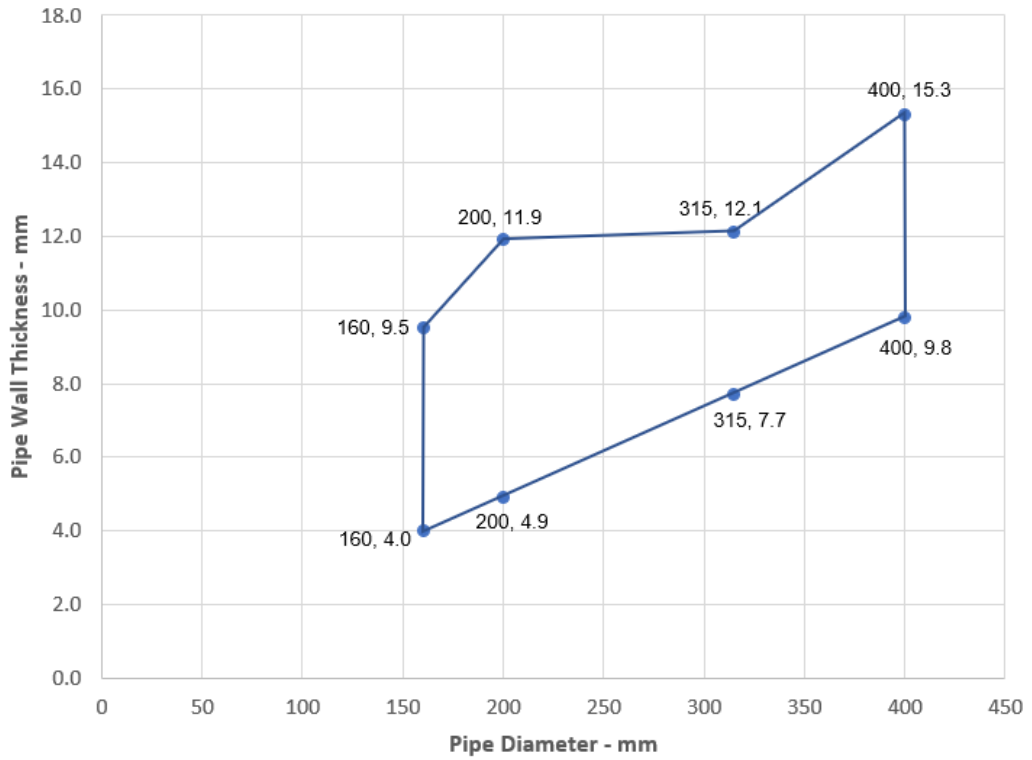

Copper or Steel Pipes - E 120 C/U

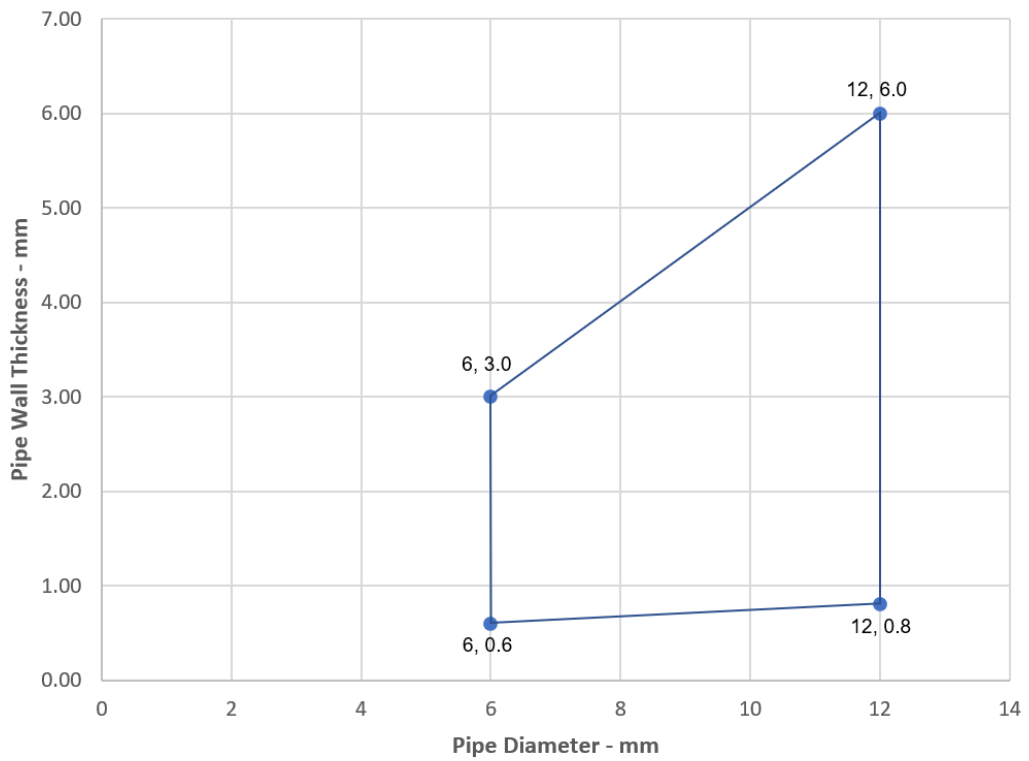

A.2 Rigid floor constructions according to 2. 2) with floor thickness of minimum 125 mm

A.2.1 Protecta FR Pipe Wrap penetration seal for plastic pipes, in Protecta FR Board

Penetration Seal: Combustible pipes sealed with Protecta FR Board, positioned to either face of the floor (or anywhere in between). Minimum separation according to 2. 5) (Configuration 1 & 2).

Construction details:

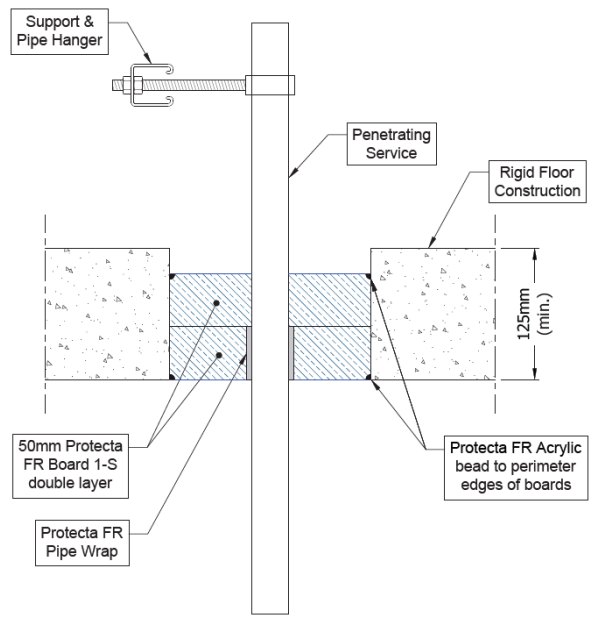
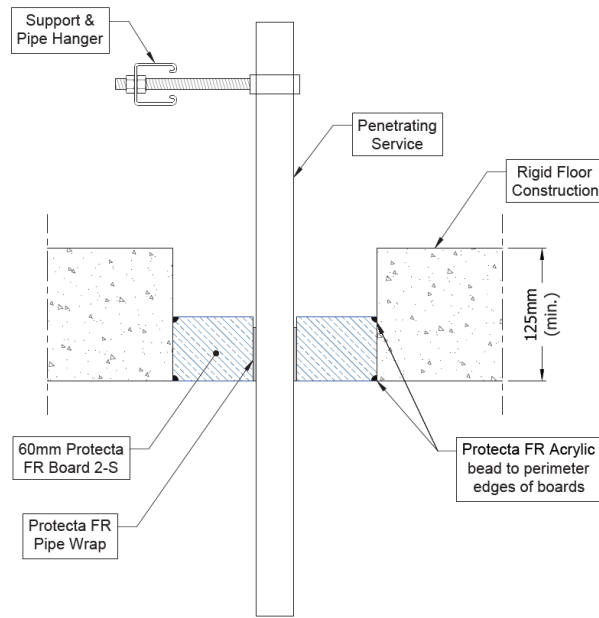

Configuration 1:

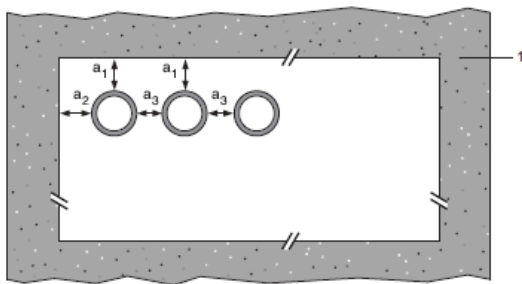

Configuration 2:

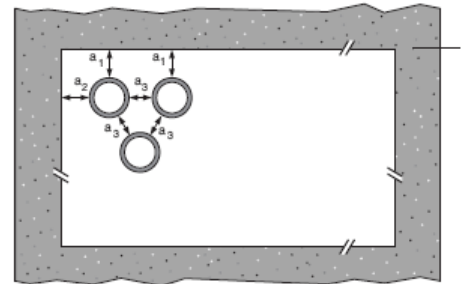

Key

- 1 Supporting construction
- a1 Pipe / top edge of seal separation
- a2 Pipe / side edge of seal separation
- a3 Pipe / pipe separation

A.2.1.1

Services	Wrap (soffit side)	FR Board configuration	Classification
PVC pipes according to 2. 7)			
Diameter up to 40 mm, wall thickness 1.9 – 3.0 mm	50 x 1.8 mm (1 layer)	Single 2-S 60 mm	E 120 U/C, EI 60 U/C
Diameter up to 110 mm, wall thickness 2.7 - 6.6 mm	50 x 3.6 mm (2 x 1.8 layer)		EI 60 U/C

Services	Wrap (soffit side)	FR Board configuration	Classification
PE pipes according to 2. 7)			
Diameter up to 40 mm, wall thickness 2.4 – 3.7 mm	50 x 1.8 mm (1 layer)	Single 2-S 60 mm	EI 60 U/C
Diameter up to 110 mm, wall thickness 3.4 – 10.0 mm	50 x 3.6 mm (2 x 1.8 layer)		EI 60 U/C

Services	Wrap (soffit side)	FR Board configuration	Classification
PP pipes according to 2. 7)			
Diameter up to 40 mm, wall thickness 1.8 – 5.5 mm	50 x 1.8 mm (1 layer)	Single 2-S 60 mm	EI 60 U/C
Diameter up to 110 mm, wall thickness 2.7 – 10.0 mm	50 x 3.6 mm (2 x 1.8 layer)		EI 60 C/C
Diameter up to 160 mm, wall thickness 4.9 - 14.6 mm	50 x 10.8 mm (6 x 1.8 layer)	Double 1-S 50 mm	EI 60 C/C

A.3 Rigid floor constructions according to 2. 2) with floor thickness of minimum 150 mm

A.3.1 Cable penetration seal with 2x Protecta FR Board 2-S

Penetration Seal: Cables fitted at any position within the aperture, with 60 mm Protecta FR Board 2-S to both sides of the floor.

Construction details:

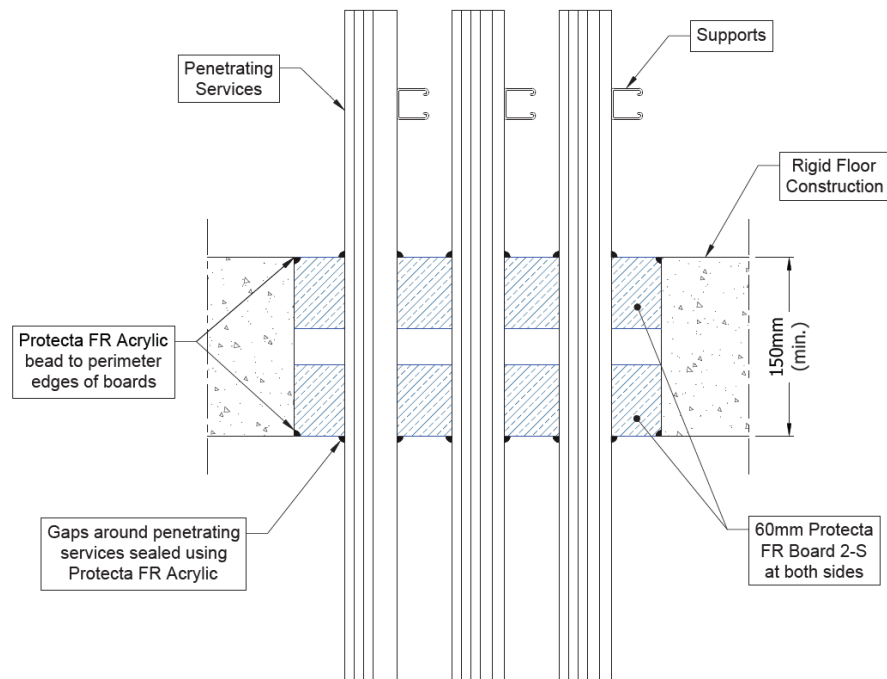

A.3.1.1 Double side penetration seal with cables

Services	Maximum aperture	Classification
None (blank)	1200 x 600 mm	EI 180
None (blank)	2400 mm x 1200 mm	E 180, EI 120
Electrical cables up to 21 mm \varnothing (single, bundled and on trays)		EI 120
Electrical cables up to 80 mm \varnothing (single, bundled and on trays)		E 120, EI 60
Cables up to 21mm \varnothing in tied bundles up to 100mm \varnothing		EI 120
Steel cable trays & ladders		E 120, EI 60
Non-sheathed wires up to 24 mm \varnothing		E 180, EI 45
Plastic conduits up to 16 mm \varnothing		E 120 C/U, E 120 C/C, EI 90 C/U, EI 90 C/C

A.3.2 Cable penetration seal with 1x Protecta FR Board 2-S

Penetration Seal: Cables fitted at any position within the aperture, with Protecta FR Board 2-S positioned to either face of the floor (or anywhere in between).

Construction details:

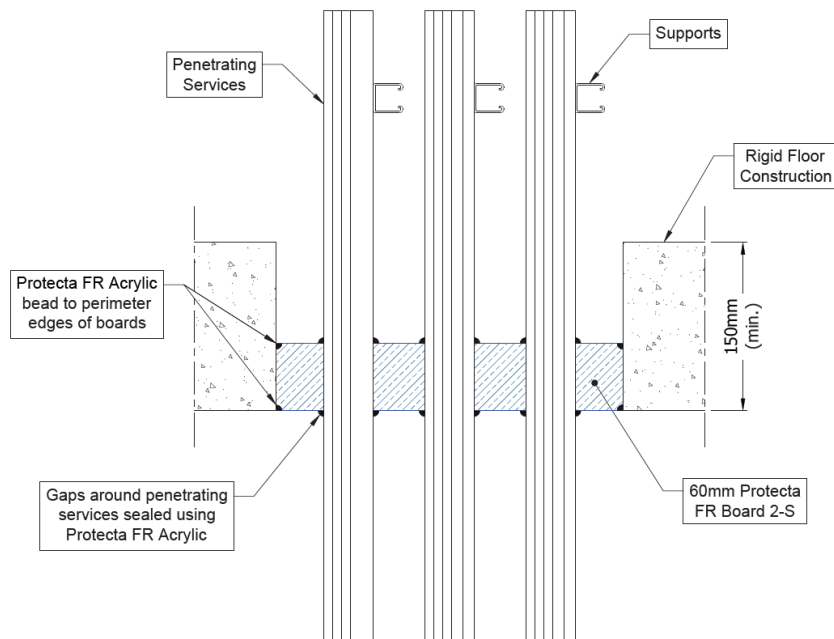

A.3.2.1 Single side penetration seal with cables

Services	Maximum aperture	Classification
None (blank)	1200 x 600 mm	E 240, EI 120
None (blank)	2400 mm x 1200 mm	E 120, EI 90
Single* electrical cables up to 21 mm Ø		E 120, EI 30
Single* electrical cables up to 21 mm Ø	600 mm x 1200 mm	E 240, EI 30
Electrical cables up to 21 mm Ø (single, bundled and on trays)	2400 mm x 1200 mm	E 90, EI 45
Electrical cables up to 80 mm Ø (single, bundled and on trays)		E 90, EI 30
Cables up to 21mm Ø in tied bundles up to 100mm Ø		EI 45
Steel cable trays & ladders		EI 45
Non-sheathed wires up to 17 mm Ø		E 45, EI 30
Non-sheathed wires up to 24 mm Ø		E 45, EI 20
Plastic conduits up to 16 mm Ø		EI 45 C/U, EI 45 C/C
Steel or copper conduit up to 16 mm Ø		E 45 C/U, EI 15 C/U

A.3.3 Bus-bar penetration seal with 2x Protecta FR Board 1-S (back to back)

Penetration Seal: Bus-bars fitted at any position within the aperture, with two layers of 50 mm Protecta FR Board 1-S installed together to either side of the floor (or anywhere in between). Minimum separation according to 2. 5).

Construction details:

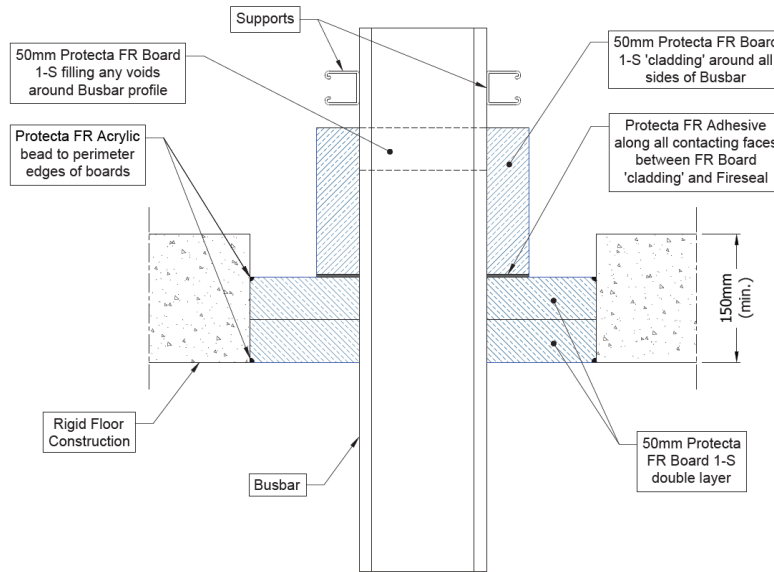
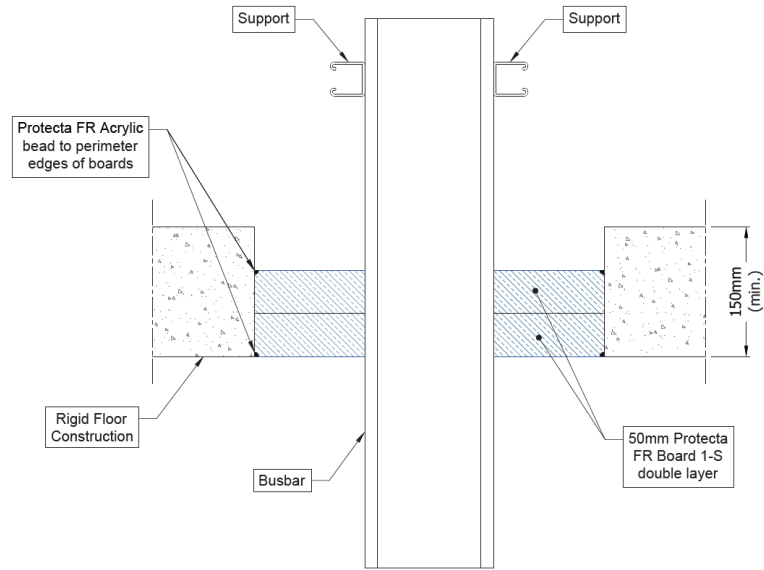

A.3.3.1 Penetration seal with electrical services

Services	Maximum aperture	Classification
Aluminium bus bars up to 592 by 150 mm and cross section up to 5275 mm ²	1200 x 600 mm	E 180, EI 20
	2400 x 1200 mm	E 120, EI 20
Aluminium bus bars up to 592 by 150 mm and cross section up to 5275 mm ² , insulated top side with 500 mm long by 50 mm thick Protecta FR Board 1-S, bonded to the fire seal with Protecta FR Adhesive and fixed with 3 pcs 80 mm pig-tails in the corners 150 mm apart	1200 x 600 mm	E 240, EI 60
	2400 x 1200 mm	E 120, EI 60

A.3.4 Pipe penetration seal with 2x Protecta FR Board 2-S

Penetration Seal: 1000 mm (min.) LI (Local Interrupted) or CI (Continuous Interrupted) insulated metallic pipes (single) fitted at any position within the aperture, with 2 layers of 60 mm Protecta FR Board 2-S together within the floor.

Construction details:

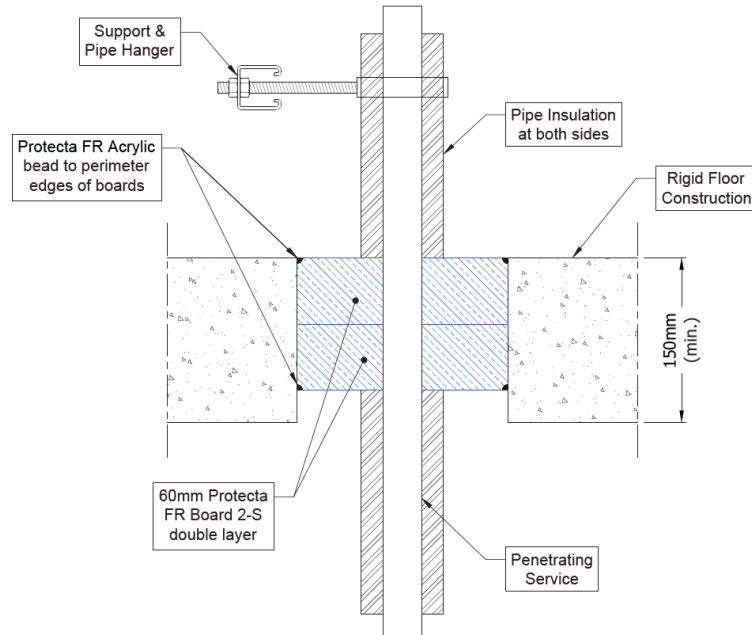

A.3.4.1 Two layer penetration seal with pipes

Services	Maximum aperture	Insulation, minimum thickness and density	Classification
Mild or stainless steel pipe			
40 mm diameter/1.5-14.2 mm wall*	1200 x 600 mm	20 mm Stone wool insulation 80 kg/m ³	EI 180 C/U
40 mm diameter/1.5-14.2 mm wall*	280 x 280 mm		EI 240 C/U
40 mm diameter/1.5-14.2 mm wall*	2400 x 1200 mm		30 mm Stone wool insulation 80 kg/m ³
40 mm diameter/1.5-14.2 mm wall*		E 180 C/U, EI 60 C/U	
50 mm diameter/1.7-14.2 mm wall*			
60 mm diameter/1.8-14.2 mm wall*			
75 mm diameter/2.1-14.2 mm wall*			
90 mm diameter/2.3-14.2 mm wall*			
100 mm diameter/2.5-14.2 mm wall*			
115 mm diameter/2.8-14.2 mm wall*			
140 mm diameter/3.2-14.2 mm wall*			
165 mm diameter/ 3.6-14.2 mm wall*			
180 mm diameter/ 3.9-14.2 mm wall*			
200 mm diameter/ 4.2-14.2 mm wall*			
219 mm diameter/ 4.5-14.2 mm wall*			

* Typical pipe diameters shown, see below graph for intermediate sizes

Pipe diameter vs Wall thickness

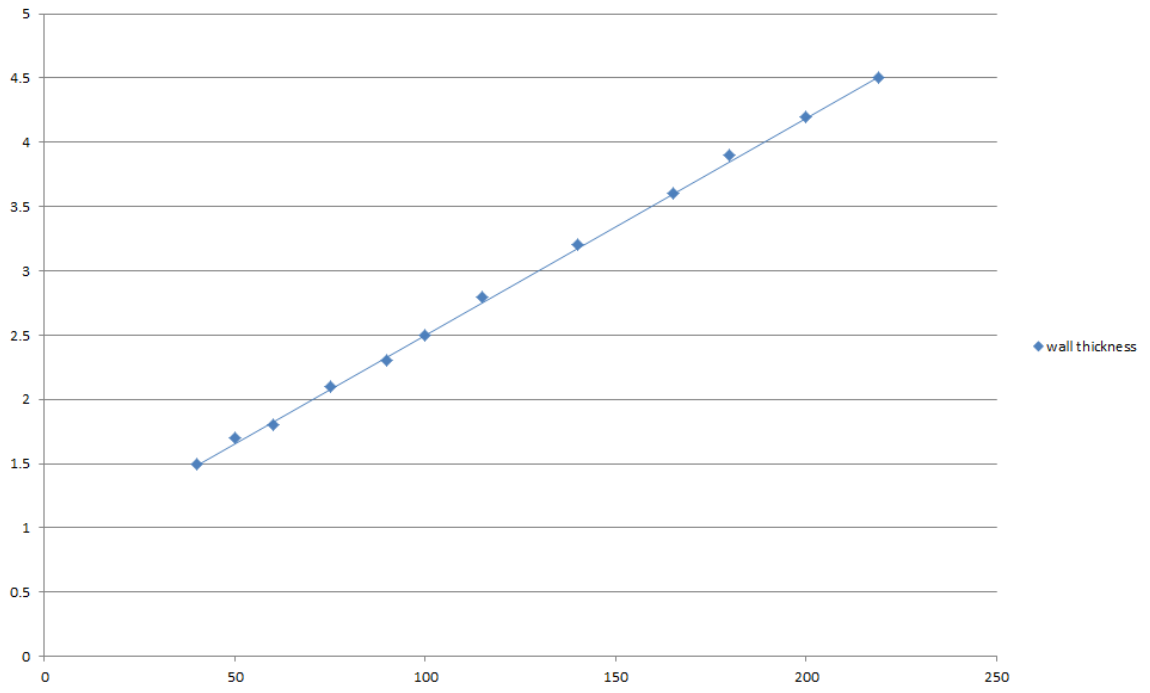

A.3.5 Pipe penetration seal with 1x Protecta FR Board 2-S

Penetration Seal: 1000 mm (min.)* LI (Local Interrupted) or CI (Continuous Interrupted) insulated metallic pipes (single) fitted at any position within the aperture, with 60 mm Protecta FR Board 2-S to either side of the floor (or anywhere in between).

Construction details:

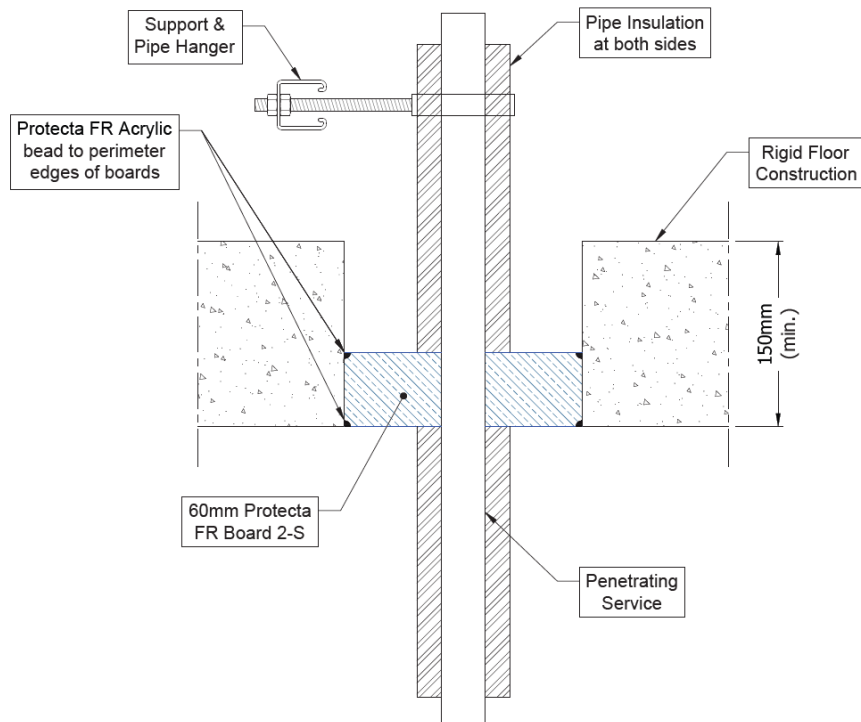

A.3.5.1 Single side penetration seal with pipes

Services	Maximum Aperture	Insulation, minimum thickness and density	Classification
Up to 12 mm diameter Copper pipe 0.9-14.2 mm wall	1200 x 600 mm	20 mm Stone wool insulation 80 kg/m ³	E 240 C/U, EI 45 C/U
Up to 54 mm diameter Copper pipe 0.9-14.2 mm wall	1200 x 600 mm		E 240 C/U
	2400 mm x 1200 mm	E 120 C/U	
114 mm diameter mild or stainless steel pipe 11-14.2 mm wall	600 x 1200 mm	None	E 240 C/C, EI 20 C/C
	2400 mm x 1200 mm		E 120 C/C, EI 20 C/C

Services	Maximum Aperture	Insulation, minimum thickness and density	Classification
Mild or stainless steel pipe			
40 mm diameter/1.5-14.2 mm wall*	600 x 1200 mm	20 mm Stone wool insulation 80 kg/m ³	E 240 C/U, EI 60 C/U
40 mm diameter/1.5-14.2 mm wall*		30 mm Stone wool insulation 80 kg/m ³	E 240 C/U, EI 90 C/U
50 mm diameter/1.7-14.2 mm wall*			
60 mm diameter/1.8-14.2 mm wall*			
75 mm diameter/2.1-14.2 mm wall*			
90 mm diameter/2.3-14.2 mm wall*			
100 mm diameter/2.5-14.2 mm wall*			
115 mm diameter/2.8-14.2 mm wall*			
140 mm diameter/3.2-14.2 mm wall*			
165 mm diameter/ 3.6-14.2 mm wall*			
180 mm diameter/ 3.9-14.2 mm wall*			
200 mm diameter/ 4.2-14.2 mm wall*			
219 mm diameter/ 4.5-14.2 mm wall*			
40 mm diameter/1.5-14.2 mm wall*	2400 mm wide by 1200 mm high	20 mm Stone wool insulation 80 kg/m ³	E 120 C/U, EI 60 C/U
40 mm diameter/1.5-14.2 mm wall*		30 mm Stone wool insulation 80 kg/m ³	E 120 C/U, EI 90 C/U
50 mm diameter/1.7-14.2 mm wall*			
60 mm diameter/1.8-14.2 mm wall*			
75 mm diameter/2.1-14.2 mm wall*			
90 mm diameter/2.3-14.2 mm wall*			
100 mm diameter/2.5-14.2 mm wall*			
115 mm diameter/2.8-14.2 mm wall*			
140 mm diameter/3.2-14.2 mm wall*			
165 mm diameter/ 3.6-14.2 mm wall*			
180 mm diameter/ 3.9-14.2 mm wall*			
200 mm diameter/ 4.2-14.2 mm wall*			
219 mm diameter/ 4.5-14.2 mm wall*			

* Typical pipe diameters shown, see below graph for intermediate sizes

Pipe diameter vs Wall thickness

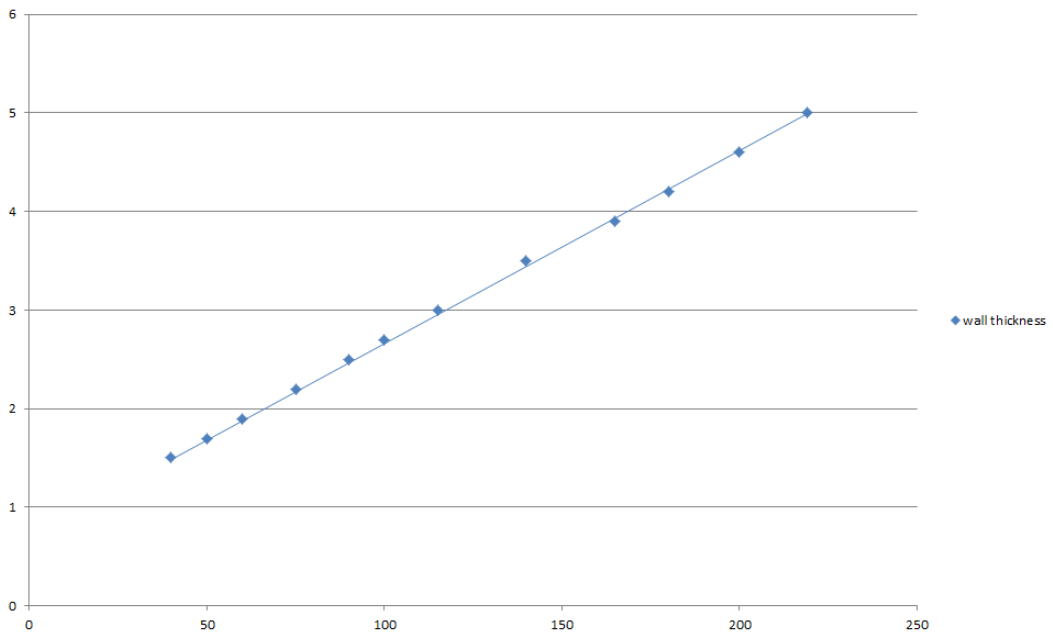

Services	Maximum Aperture	Insulation (minimum)	Classification
Geberit Mepla MLC (PE-Xb/Aluminium/PE-HD pipe)			
16 mm diameter/2.25 mm wall	75 x 75 mm		E 240 C/C, EI 180 C/C
16 mm diameter/2.25 mm wall	600 x 1200 mm	500 mm long, 20 mm Stone wool insulation 80 kg/m ³	E 240 C/C, EI 90 C/C
20 mm diameter/2.5 mm wall			
26 mm diameter/3 mm wall			
32 mm diameter/3 mm wall			
40 mm diameter/3.5 mm wall			
50 mm diameter/4 mm wall			
63 mm diameter/4.5 mm wall	2400 mm x 1200 mm		E 120 C/C, EI 90 C/C
75 mm diameter/4.7 mm wall			
16 mm diameter/2.25 mm wall			
20 mm diameter/2.5 mm wall			
26 mm diameter/3 mm wall			
32 mm diameter/3 mm wall			
40 mm diameter/3.5 mm wall			
50 mm diameter/4 mm wall			
63 mm diameter/4.5 mm wall			
75 mm diameter/4.7 mm wall			

A.3.6 Pipe penetration seal with 1x Protecta FR Board 2-S

Penetration Seal: Combustible pipes fitted at any position within the aperture, with 50 mm Protecta FR Board 2-S at mid-depth of the floor. Protecta FR Pipes Wraps are required to be fitted around combustible pipe insulation. Maximum aperture size 2400 mm x 1200 mm

Construction details:

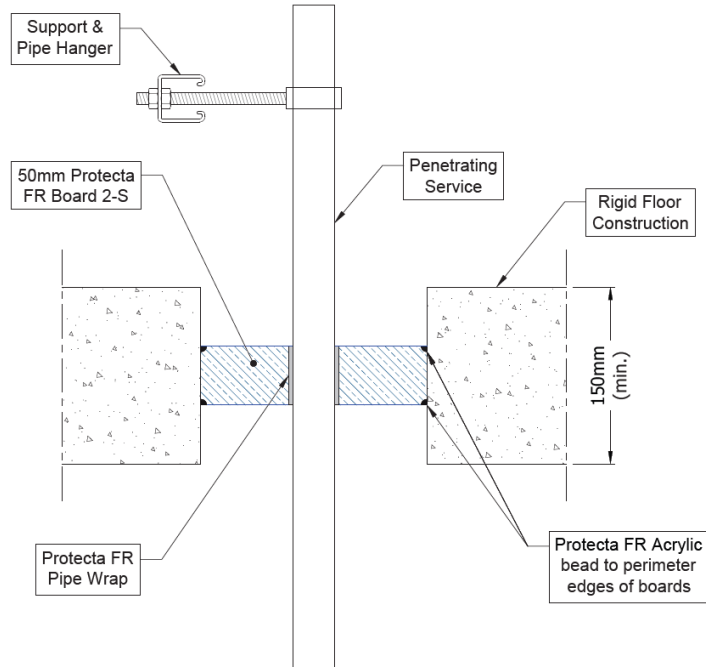

A.3.6.1 Central penetration seal with pipes

Services	Wrap	Classification
PVC-U pipe according to EN 1329-1, EN 1452-1 and EN 1453-1* 110 mm diameter/ 3.4mm wall	50 x 3.6 mm Protecta FR Pipe Wrap	EI 90 U/C, EI 90 C/C

A.3.7 Pipe penetration seal with 1x Protecta FR Board 2-S

Penetration Seal: CS (Continuous Sustained) insulated metallic pipes fitted at any position within the aperture, with 60 mm Protecta FR Board 2-S to either side of the floor (or anywhere in between). Protecta FR Pipes Wraps are required to be fitted around combustible pipe insulation. Maximum aperture size 2400 mm x 1200 mm

Construction details:

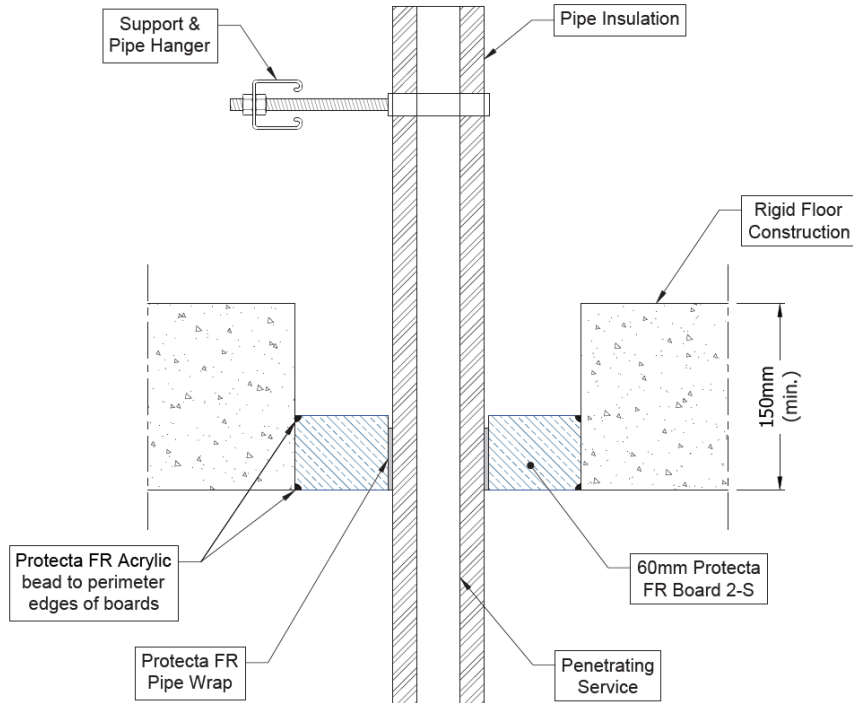

A.3.7.1 Single side penetration seal with pipes

Services	Wrap	Insulation	Classification
Mild or stainless steel pipe			
165 mm diameter/ 4.5-14.2 mm wall	50 x 3.6 mm Protecta FR Pipe Wrap fitted at bottom of seal	13 mm elastomeric insulation min. class B-s3, d0	E 90 C/U, EI 45 C/U
		19 mm elastomeric insulation min. class B-s3, d0	EI 90 C/U
	Not required	25-40 mm stone wool min. 80 kg/m ³	E 90 C/U, EI 60 C/U

A.3.8 Pipe penetration seal with 2x Protecta FR Board 2-S

Penetration Seal: CS (Continuous Sustained) insulated metallic pipes fitted at any position within the aperture, with 60 mm Protecta FR Board 2-S to both sides of the floor. Protecta FR Pipes Wraps are required to be fitted around combustible pipe insulation at the soffit. Maximum aperture size 2400 mm x 1200 mm

Construction details:

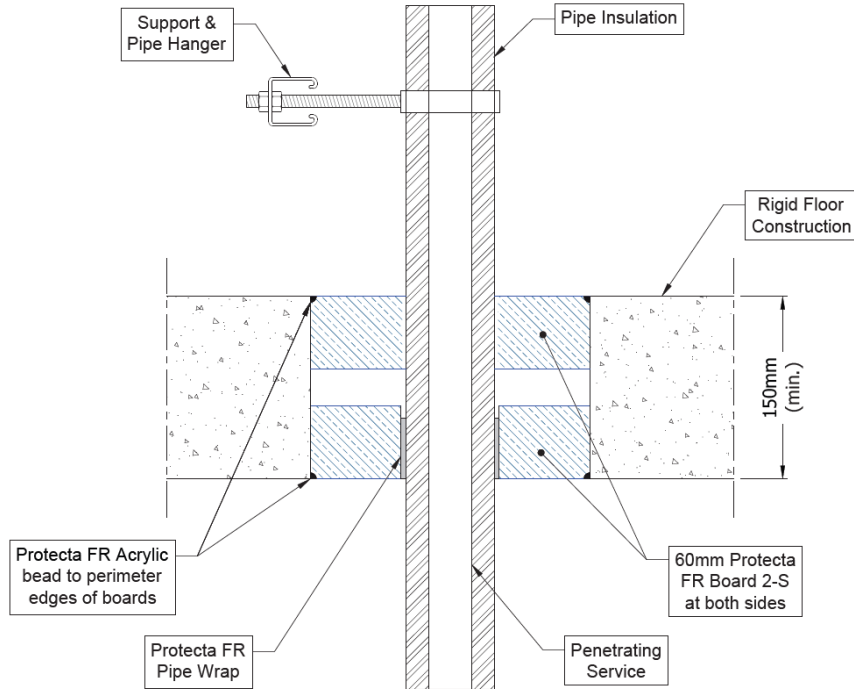

A.3.8.1 Double side penetration seal with pipes

Services	Wrap	Insulation	Classification
Mild or stainless steel pipe			
Up to 40 mm diameter/ 1-14.2 mm wall	50 x 1.8 mm Protecta FR Pipe Wrap	13 mm elastomeric insulation min. class B-s3, d0	E 180 C/U, EI 120 C/U

A.3.9 Pipe penetration seal with 2x Protecta FR Board 2-S (back to back)

Penetration Seal: CS (Continuous Sustained) insulated metallic and composite pipes fitted at any position within the aperture, with two layers of 60 mm Protecta FR Board 1-S installed together to either side of the floor (or anywhere in between). Protecta FR Pipes Wraps are required to be fitted around combustible pipe insulation at the bottom of the seal. Maximum aperture size 2400 mm x 1200 mm

Construction details:

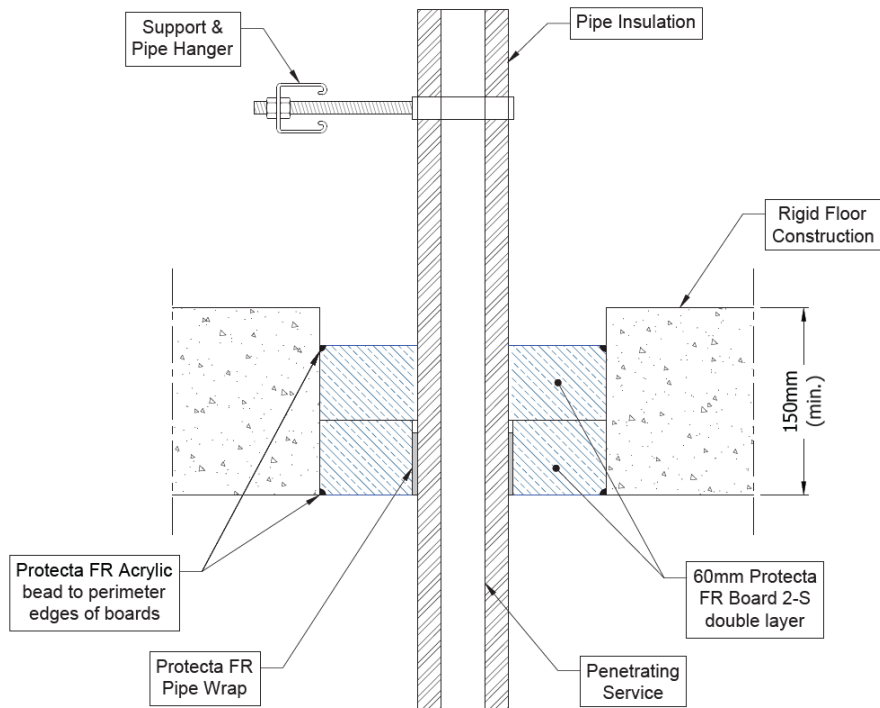

A.3.9.1 Back to back penetration seal with pipes

Services	Wrap	Insulation	Classification
Copper pipe			
12-54 mm diameter/1-1.2 mm wall	50 x 3.6 mm Protecta FR Pipe Wrap fitted to the bottom of the seal	9-13 mm elastomeric insulation min. class B-s3, d0	E240 C/C, EI 60 C/C
12-54 mm diameter/1-1.2 mm wall		13-25 mm elastomeric insulation min. class B-s3, d0	E 180 C/C, EI 45 C/C
Geberit Mepla MLC (PE-Xb/Aluminium/PE-HD pipe)			
16 mm diameter/2.25 mm wall	50 x 3.6 mm Protecta FR Pipe Wrap fitted to the bottom of the seal	9 mm elastomeric insulation min. class B-s3, d0	EI 120 C/C
20 mm diameter/2.5 mm wall			
26 mm diameter/3 mm wall			
32 mm diameter/3 mm wall			
40 mm diameter/3.5 mm wall			
50 mm diameter/4 mm wall			
63 mm diameter/4.5 mm wall		13-25 mm elastomeric insulation min. class B-s3, d0	E 60 C/C, EI 45 C/C
75 mm diameter/4.7 mm wall			
16 mm diameter/2.25 mm wall			
20 mm diameter/2.5 mm wall			
26 mm diameter/3 mm wall			
32 mm diameter/3 mm wall			
40 mm diameter/3.5 mm wall			
50 mm diameter/4 mm wall			
63 mm diameter/4.5 mm wall			
75 mm diameter/4.7 mm wall			

A.4 Timber floor constructions according to 2. 2) with floor thickness of minimum 150 mm

A.4.1 Cable penetration seal with 2x Protecta FR Board 1-S

Penetration Seal: Cables fitted at any position within the aperture, with 2 layers of 50 mm Protecta FR Board 1-S within the floor with the coated sides downwards. The external board layer has a minimum 100 mm overlap all around the aperture.

Construction details:

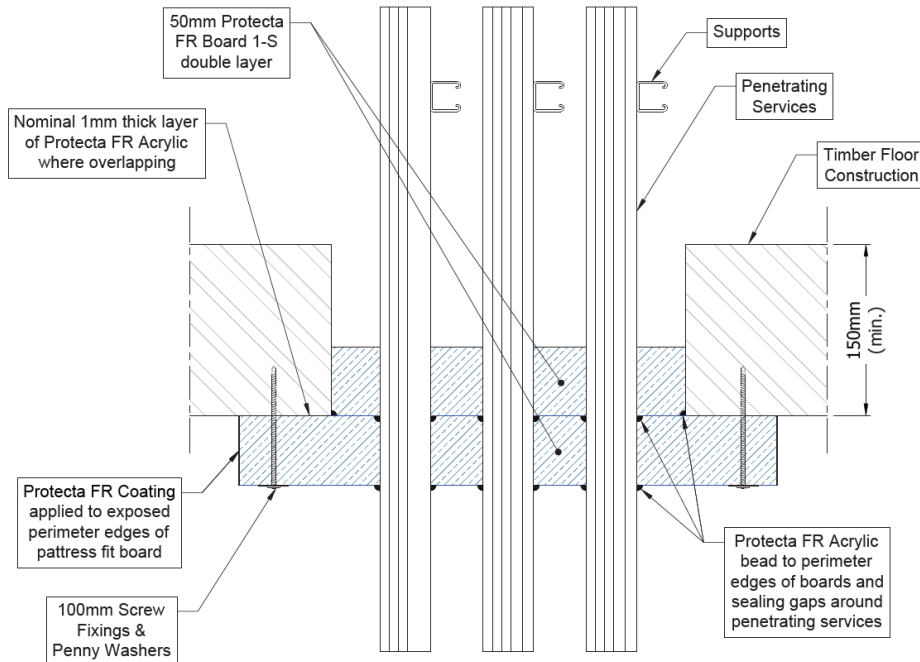

A.4.1.1 Back to back penetration seal with cables

Services	Maximum aperture	Classification
Electrical cables up to 21 mm \varnothing (single, bundled and on trays)	1200 mm x 600 mm	E 90, EI 45
Electrical cables up to 50 mm \varnothing (single, bundled and on trays)		E 90, EI 60
Electrical cables up to 80 mm \varnothing (single, bundled and on trays)		E 90, EI 60
Cables up to 21mm \varnothing in tied bundles up to 100mm \varnothing		E 90, EI 60
Steel cable trays & ladders		E 90, EI 60
Non-sheathed wires up to 24 mm \varnothing		E 90, EI 30
PE-X pipe-in-pipe up to 25 mm diameter / 1.0 mm wall		EI 90 C/C

A.4.2 Pipe penetration seal with 2x Protecta FR Board 1-S

Penetration Seal: 500 mm (min.)* LI (Local Interrupted) or CI (Continuous Interrupted) insulated metallic pipes fitted at any position within the aperture, with 2 layers of 50 mm Protecta FR Board 1-S within the floor with the coated sides downwards. The external board layer has a minimum 100 mm overlap all around the aperture.

Construction details:

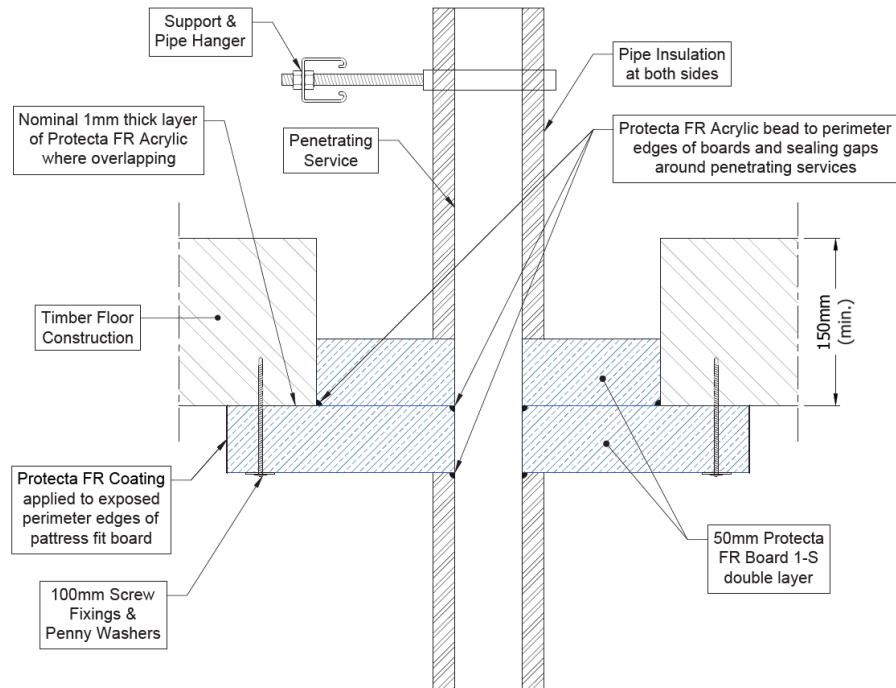

A.4.2.1 Back to back penetration seal with pipes

Services	Max. aperture	Insulation, minimum thickness and density	Classification
Mild or stainless steel pipe			
60 mm diameter*	1200 mm x 600 mm	20 mm glass or stone wool insulation 75 kg/m ³	E 90 C/U, EI 60 C/U
273 mm diameter*		25 mm glass or stone wool insulation 75 kg/m ³	E 90 C/U, EI 60 C/U
Copper or steel pipes			
15 mm diameter*	1200 mm x 600 mm	20 mm glass or stone wool insulation 75 kg/m ³	EI 90 C/C
54 mm diameter*			EI 90 C/C
Alupex pipes			
16 mm diameter*	1200 mm x 600 mm	20 mm glass or stone wool insulation 75 kg/m ³	E 90 C/C, EI 60 C/C
75 mm diameter*			

*See below graphs for interpolation pipe sizes

Mild or Stainless Steel Pipes - E 90 C/U, EI 60 C/U

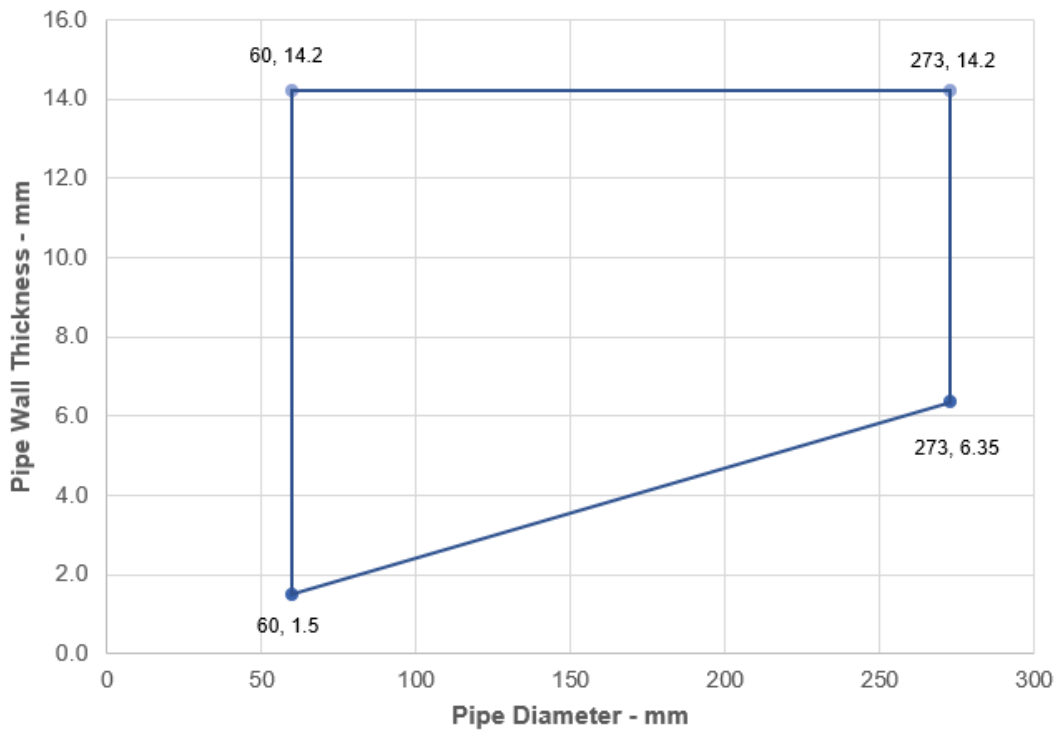

Copper or Steel Pipes- EI 90 C/C

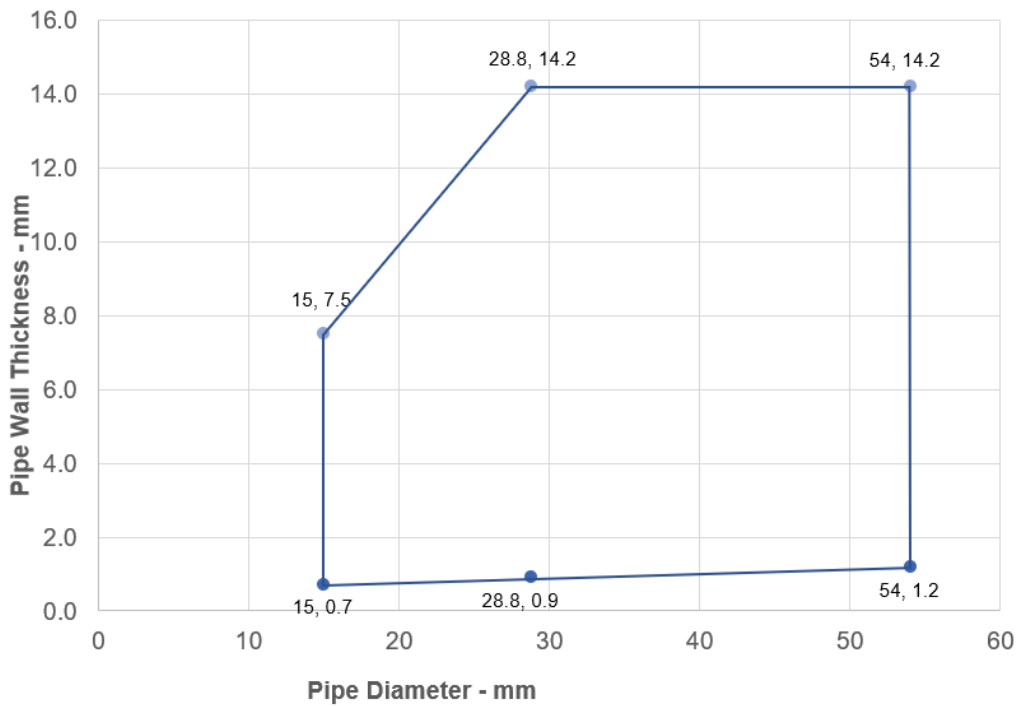

ALUPEX Pipes - E 90 C/C, EI 60 C/C

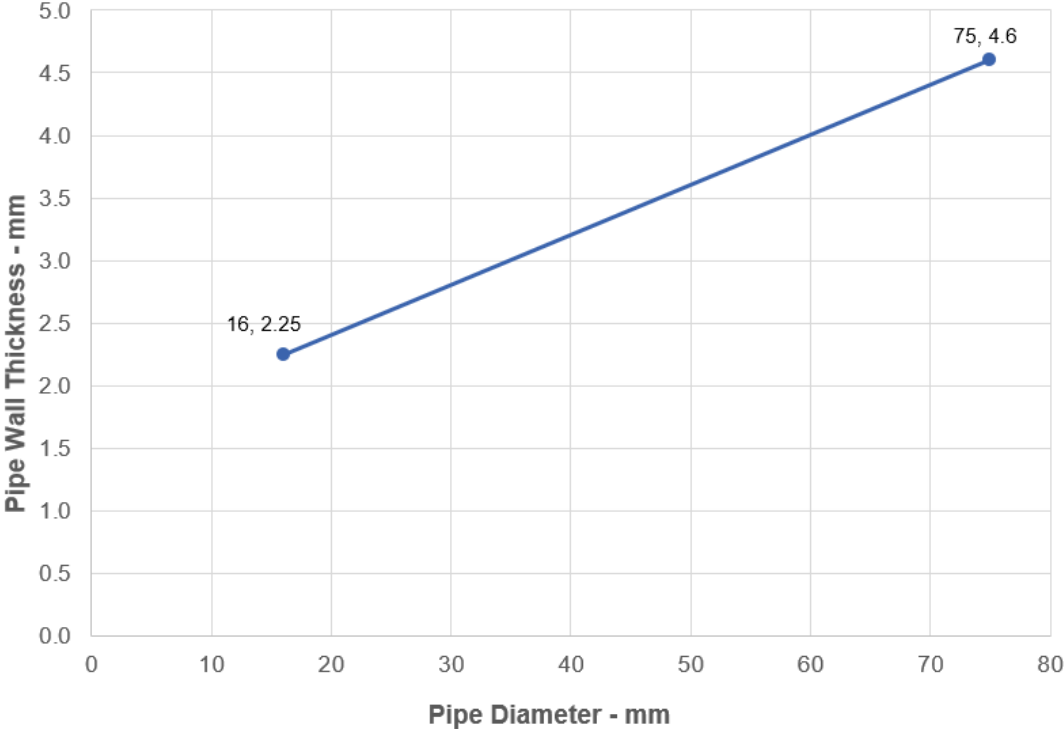

A.5 Flexible or rigid wall constructions according to 2. 2) with wall thickness of minimum 75 mm

A.5.1 Cable penetration seal with 2x Protecta FR Board 30 1-S

Penetration Seal: Cables and pipes fitted at any position within the aperture, with 30 mm Protecta FR Board 1-S to both sides of the wall.

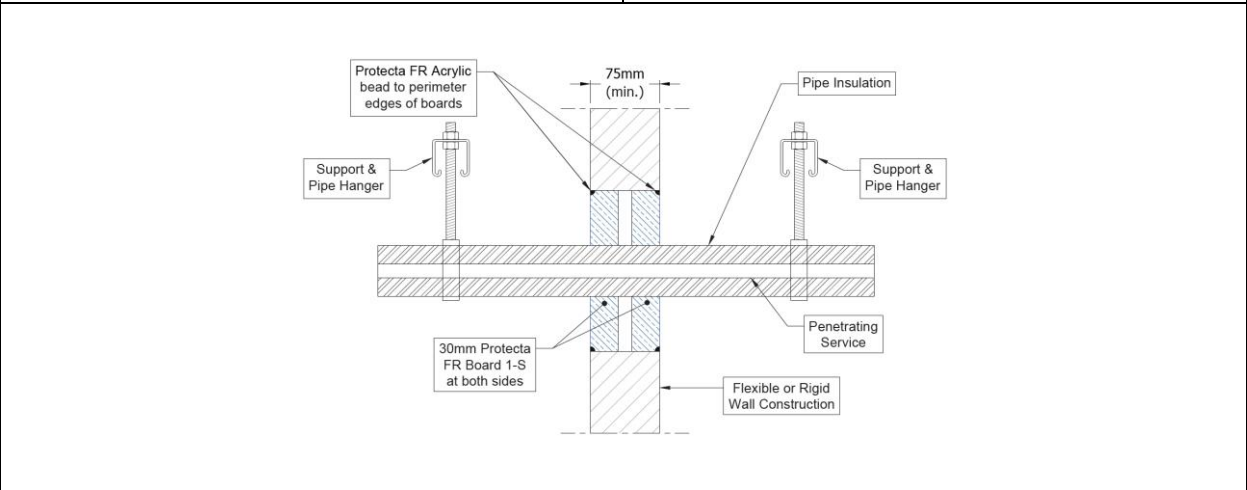
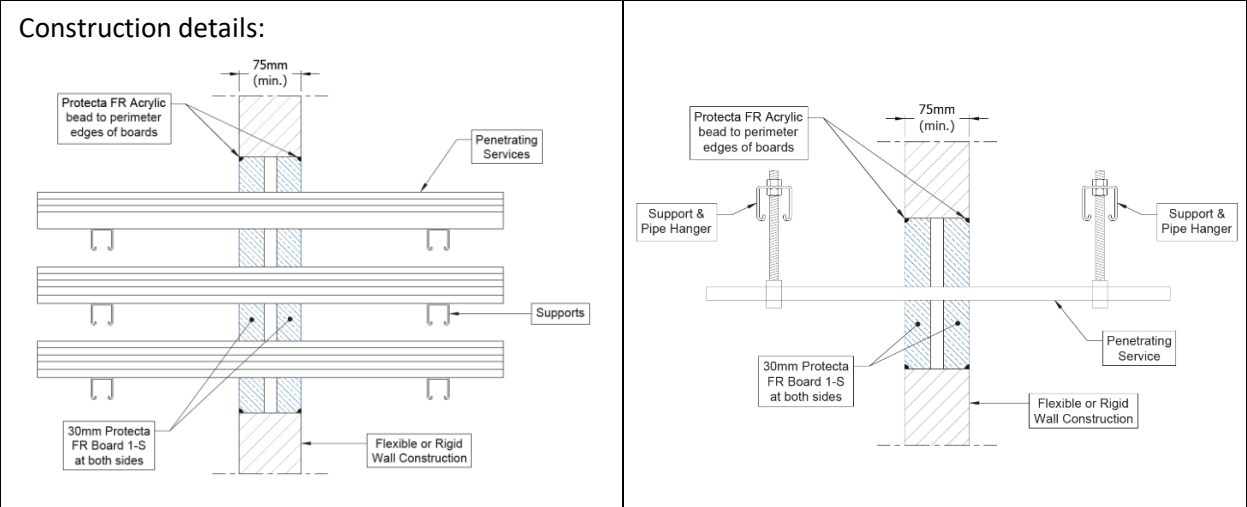

A.5.1.1 Double side penetration seal with cables and pipes

Services	Maximum aperture	Classification
Electrical cables up to 21 mm \varnothing (single, bundled and on trays)	1200 mm wide x 600 mm high	EI 45
Electrical cables up to 80 mm \varnothing (single, bundled and on trays)		E 45, EI 30
Cables including telecoms up to 21mm \varnothing in tied bundles up to 100mm \varnothing		
Steel cable trays & ladders		
Unsheathed wires up to 24 mm \varnothing		E 45, EI 20
Plastic conduits maximum 32 mm diameter		EI 45

Services	Maximum Aperture	Insulation, minimum thickness and density - CS	Classification
Mild or stainless steel pipe	1200 mm wide x 600 mm high	None	EI 45 C/U
4 mm diameter/0.7-14.2 mm wall			E 45 C/U, EI 30 C/U
22 mm diameter/2.0-14.2 mm wall		20 mm Stone wool insulation 80 kg/m ³	EI 45 C/U
40 mm diameter/1.0-14.2 mm wall*			
40 mm diameter/1.0-14.2 mm wall*			
50 mm diameter/1.7-14.2 mm wall*			
60 mm diameter/1.8-14.2 mm wall*			
75 mm diameter/2.1-14.2 mm wall*			
90 mm diameter/2.3-14.2 mm wall*			
100 mm diameter/2.5-14.2 mm wall*			
115 mm diameter/2.8-14.2 mm wall*			
140 mm diameter/3.2-14.2 mm wall*			
165 mm diameter/ 3.6-14.2 mm wall*			
180 mm diameter/ 3.9-14.2 mm wall*			
200 mm diameter/ 4.2-14.2 mm wall*			
219 mm diameter/ 4.5-14.2 mm wall*			
250 mm diameter/ 5.0-14.2 mm wall*			
300 mm diameter/ 5.9-14.2 mm wall*			
324 mm diameter/ 6.35-14.2 mm wall*	30 mm Stone wool insulation 80 kg/m ³	EI 45 C/U	

* Typical pipe diameters shown, see below graph for intermediate sizes

CS – Continuous Sustained

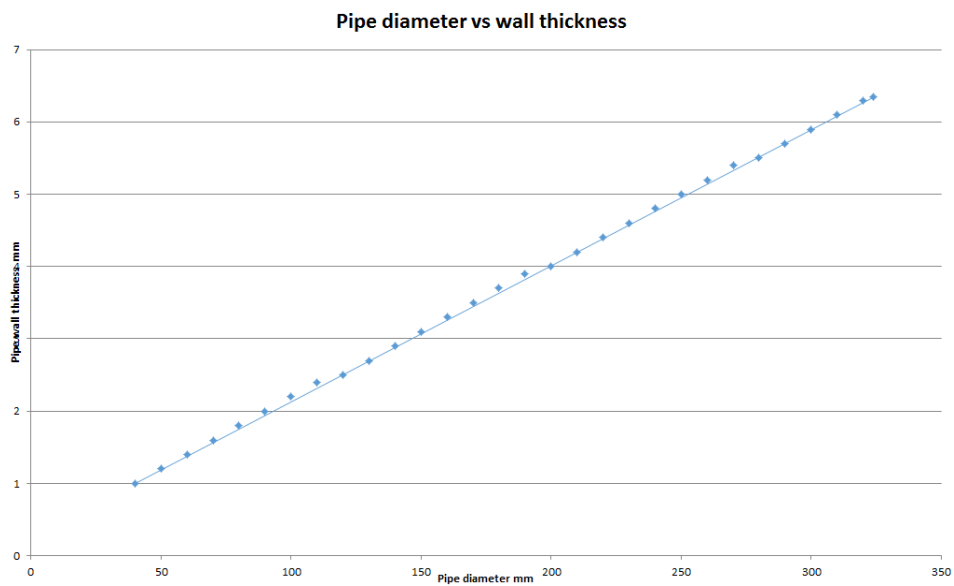

A.5.2 Cable penetration seal with 2x Protecta FR Board 1-S

Penetration Seal: Cables fitted at any position within the aperture, with 50 mm Protecta FR Board 1-S to both sides of the wall.

Construction details:

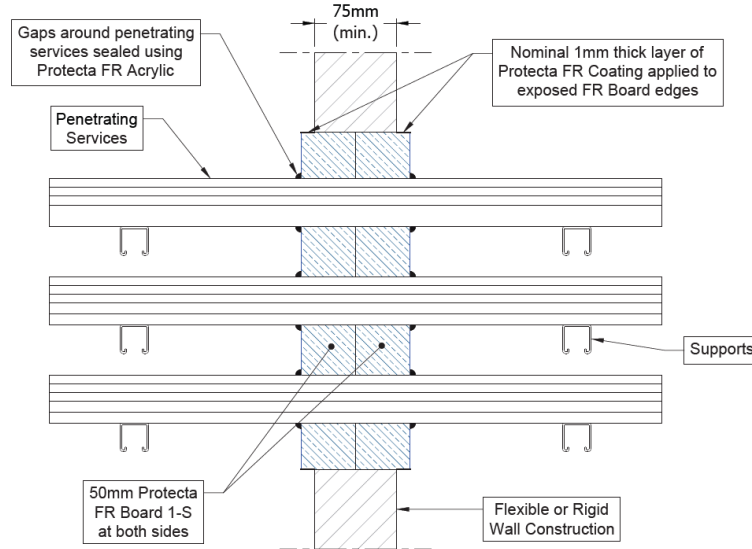
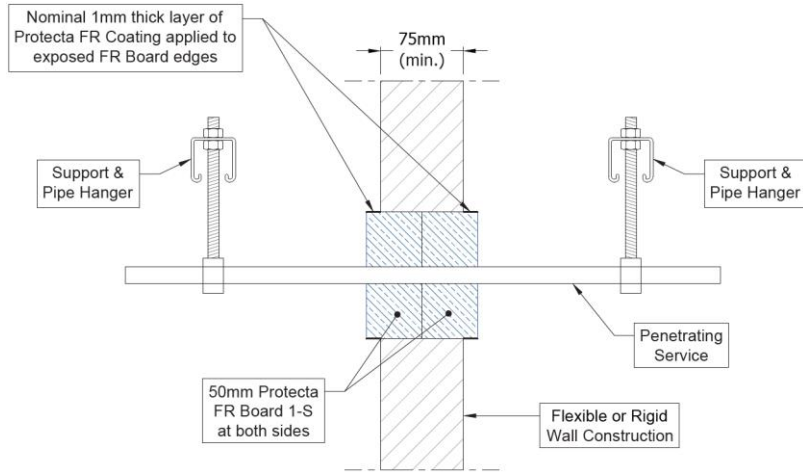

A.5.2.1 Double side penetration seal with cables

Services	Maximum aperture	Classification
None (blank)	As section 2. 5)	EI 60
Single electrical cables up to 21 mm \varnothing		EI 60
Electrical cables up to 80 mm \varnothing (single, bundled and on trays)		E 60, EI 45
Cables up to 21mm \varnothing in tied bundles up to 100mm \varnothing		EI 60
Steel cable trays & ladders		EI 60 C/U
Steel conduit up to 16 mm \varnothing		E 60 C/U, EI 45 C/U
Copper conduit up to 16 mm \varnothing		E 60, EI 30
Unsheathed wires up to 24 mm \varnothing		EI 60 C/U, EI 60 C/C
Plastic conduits up to 16 mm \varnothing		

A.6 Flexible or rigid wall constructions according to 2. 2) with wall thickness of minimum 100 mm

A.6.1 Cable penetration seal with 2x Protecta FR Board 1-S

Penetration Seal: Cables fitted at any position within the aperture, with 50 mm Protecta FR Board 1-S to both sides of the wall.

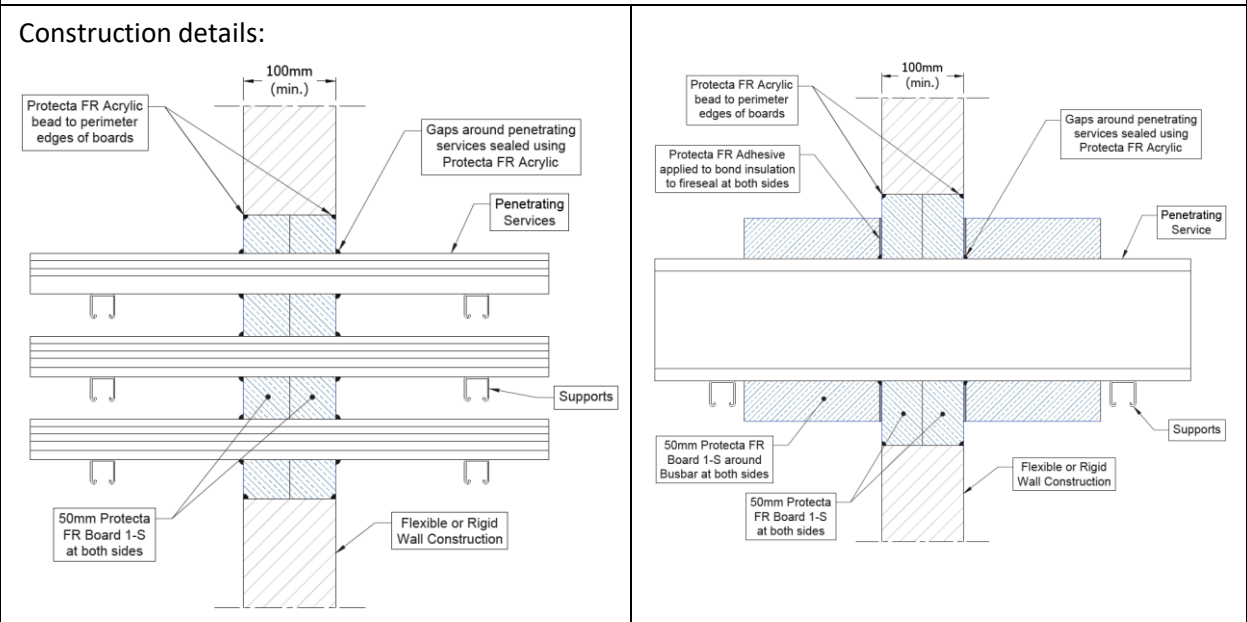

A.6.1.1 Double side penetration seal with electrical services

Services	Maximum aperture	Classification
None (blank)	As section 2. 5)	EI 120
Single electrical cables up to 21 mm Ø		E 120, EI 60
Electrical cables up to 80 mm Ø (single, bundled and on trays)		EI 60
Cables up to 21mm Ø in tied bundles up to 100mm Ø		
Steel cable trays & ladders		EI 60 C/U
Steel conduit up to 16 mm Ø		E 60 C/U, EI 45 C/U
Copper conduit up to 16 mm Ø		E 60, EI 30
Unsheathed wires up to 24 mm Ø		EI 60 C/U, EI 60 C/C
Plastic conduits up to 16 mm Ø		E 90, EI 20
Aluminium bus bars up to 592 by 150 mm and cross section up to 5275 mm ²		EI 90
Aluminium bus bars up to 592 by 150 mm and cross section up to 5275 mm ² , insulated both sides with 500 mm long by 50 mm thick Protecta FR Board 1-S, bonded to the fire seal with Protecta FR Adhesive and fixed with 3 pcs 80 mm pig-tails in the corners 150 mm apart		

A.6.2 Pipe penetration seal with 2x Protecta FR Board 1-S

Penetration Seal: CS (Continuous Sustained) insulated metallic pipes fitted at any position within the aperture, with 50 mm Protecta FR Board 1-S to both sides of the wall. Minimum separation between penetration seals and seal edges of 30 mm.

Construction details:

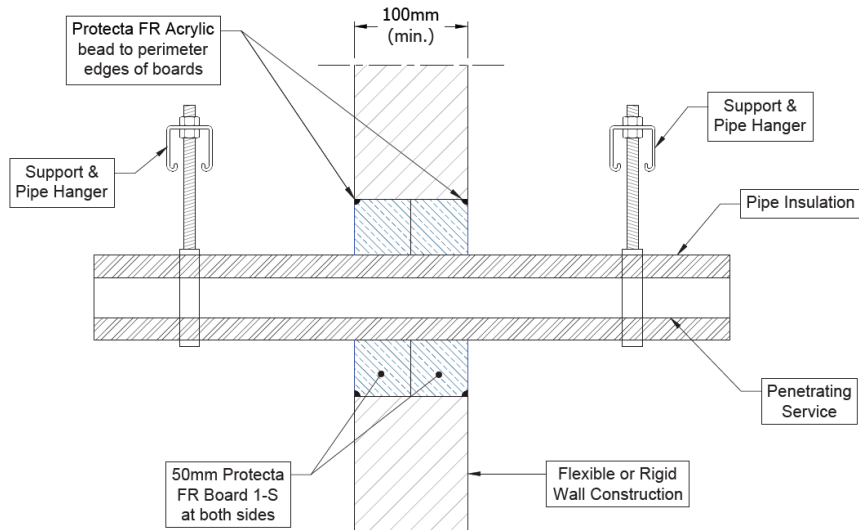

Configuration 1:

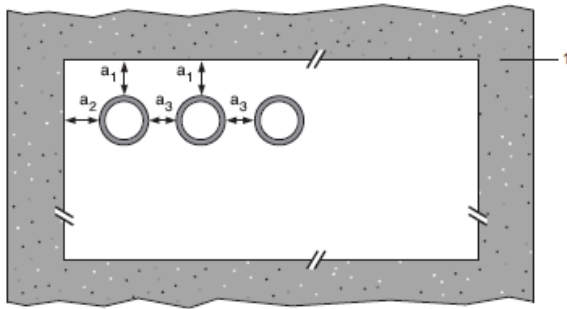

Configuration 2:

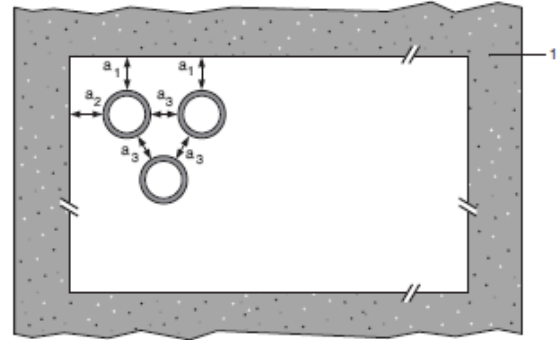

Key

- 1 Supporting construction
- a1 Pipe / top edge of seal separation
- a2 Pipe / side edge of seal separation
- a3 Pipe / pipe separation

A.6.2.1 Double side penetration seal with pipes

Services	Insulation	Classification
Mild or stainless steel pipe	20 mm thick stone, mineral wool min. 80 kg/m ³	EI 120 C/U
40 mm diameter/1-14.2 mm wall		
40 mm diameter/1-14.2 mm wall*		
50 mm diameter/1.2-14.2 mm wall*		
60 mm diameter/1.4-14.2 mm wall*		
75 mm diameter/1.6-14.2 mm wall*		
90 mm diameter/1.9-14.2 mm wall*		
100 mm diameter/2.1-14.2 mm wall*		
115 mm diameter/2.4-14.2 mm wall*		
140 mm diameter/2.9-14.2 mm wall*		
165 mm diameter/ 3.4-14.2 mm wall*		
180 mm diameter/ 3.6-14.2 mm wall*		
200 mm diameter/ 4.0-14.2 mm wall*		
219 mm diameter/ 4.3-14.2 mm wall*		
250 mm diameter/ 5.0-14.2 mm wall*		
300 mm diameter/ 5.9-14.2 mm wall*		
324 mm diameter/ 6.35-14.2 mm wall*		
PEX pipe in pipe system	None	EI 90 C/C
15 mm diameter x 2.5 mm wall inner /25mm diameter outer		

Pipe Diameter vs wall thickness

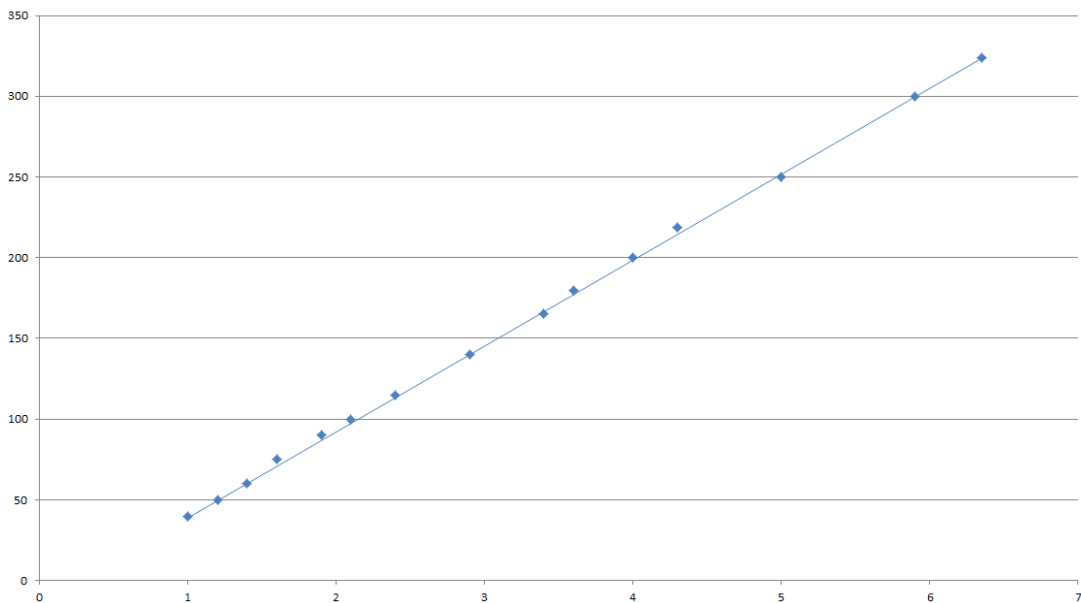

Services	Insulation	Classification
Mild or stainless steel pipe		
4 mm diameter*	None	EI 120 C/U
5-22 mm diameter*		E 120 C/U, EI 60 C/U
23-114 mm diameter*		E 90 C/U, EI 20 C/U
Up to 273 mm diameter/0.7-14.2 mm wall*	30-60 mm thick glass wool min. 75 kg/m ³	EI 60 C/U
Copper, mild or stainless steel pipe		
Up to 6 mm diameter/0.7-14.2 mm wall	None	E 120 C/C, EI 60 C/C
Up to 15 mm diameter/0.7-7.5 mm wall	20 mm thick glass or stone wool min. 75 kg/m ³	EI 60 C/C
16-54 mm diameter/0.7-14.2 mm wall*		E 60 C/C, EI 45 C/C
Up to 54 mm diameter/0.7-14.2 mm wall*	20-40 mm thick glass or stone wool min. 75 kg/m ³	E 120, EI 45 C/C
Up to 54 mm diameter/0.7-14.2 mm wall*	30-60 mm thick glass or stone wool min. 75 kg/m ³	EI 60 C/C
Alupex pipe		
16 -20 mm diameter/2.0 mm wall	None	EI 120 C/C
16 mm diameter/2.0-2.25 mm wall	20 mm thick glass or stone wool min. 75 kg/m ³	E 120 C/C, EI 90 C/C
16-75 mm diameter*	25-60 mm thick glass or stone wool min. 75 kg/m ³	E 120 C/C, EI 90 C/C
Gas pipe		
DN 40 mm semi-rigid steel gas pipe	None	EI 120 C/C
DN 12-39 mm semi-rigid steel gas pipe		E 120 C/C, EI 60 C/C
PVC-U~ pipe		
6 mm diameter*	None	EI 120 U/C
7-32 mm diameter*		EI 60 U/C
32 mm diameter*		EI 90 U/C
PE^ pipe		
20 mm diameter/2.0 mm wall	None	E 120 U/C, EI 90 U/C
21-32 mm diameter/2.0-3.0 mm wall		EI 60 U/C
32 mm diameter/3.0 mm wall		EI 90 U/C
PP pipe		
20 mm diameter/2.2 mm wall	None	E 120 U/C, EI 60 U/C
Up to 32 mm diameter/1.8 mm wall		
Up to 32 mm diameter/1.9-4.4 mm wall		EI 45 C/C

*See below graphs for interpolation pipe sizes

~ PVC-U pipe according to EN 1329-1, EN 1452-1 and EN 1453-1 and PVC-C according to EN 1566-1

^ PE pipe according to EN 1519-1, EN 12201-2 and EN 12666-1, ABS according to EN 1455-1 and pipes made from SAN+PVC according to EN 1565-1

Mild or Stainless Steel Pipes - E 120 C/U, EI 60 C/U

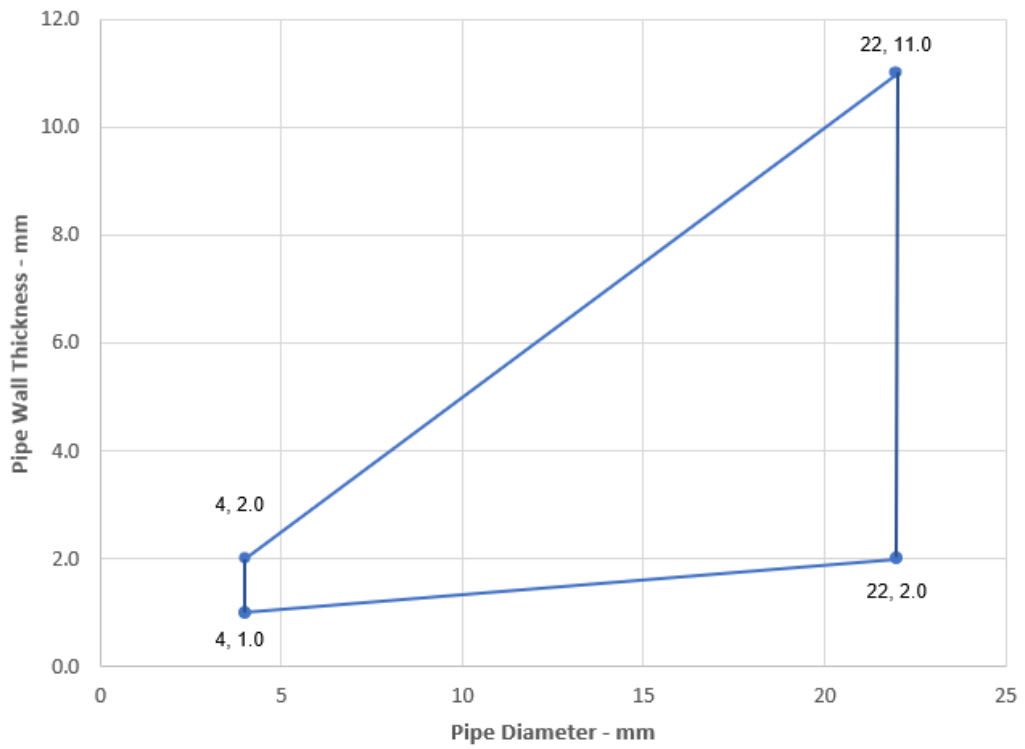

Mild or Stainless Steel Pipes - C/U

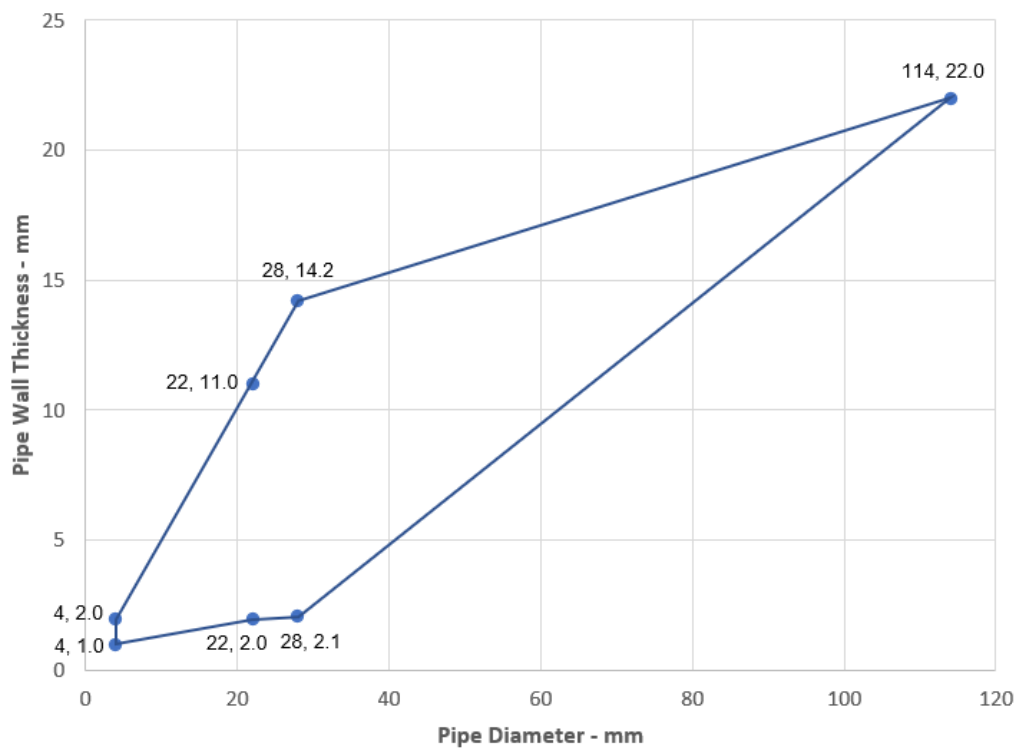

Mild or Stainless Steel Pipes with Glass Wool Insulation - EI 60 C/U

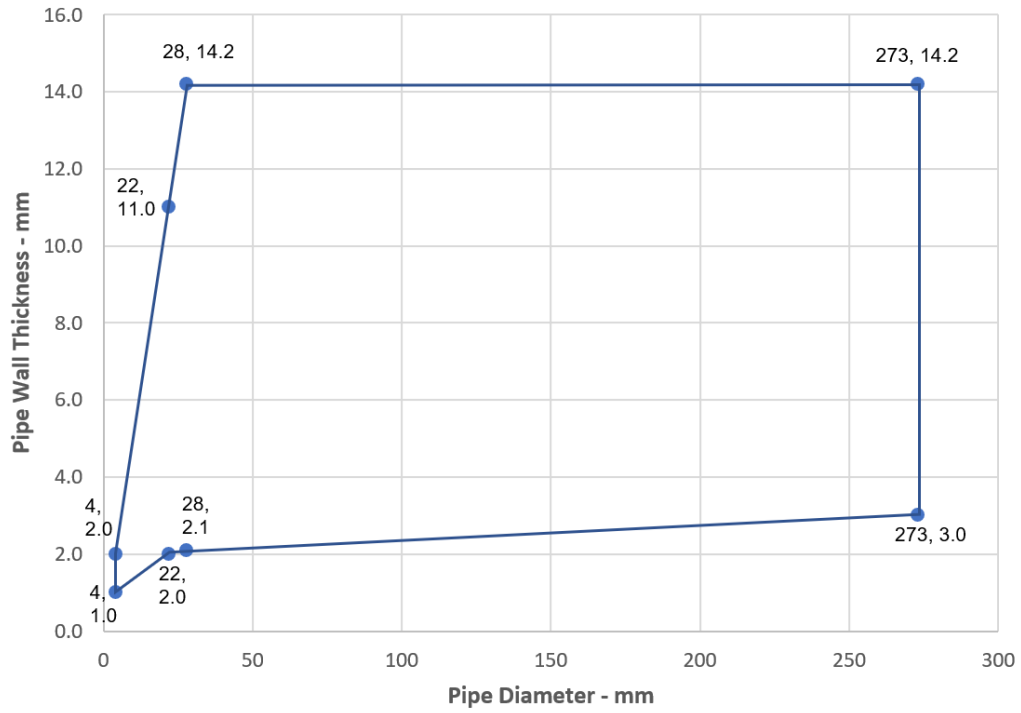

Copper or Steel Pipes with Glass or Stone Wool Insulation - C/C

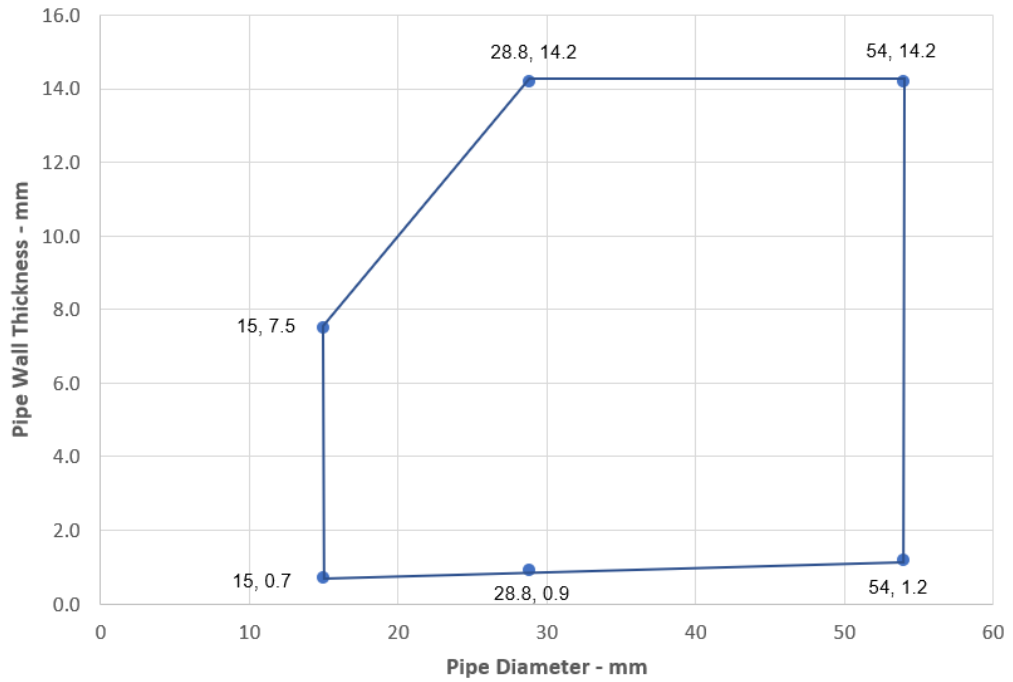

Alupex Pipes - E 120 C/C, EI 90 C/C

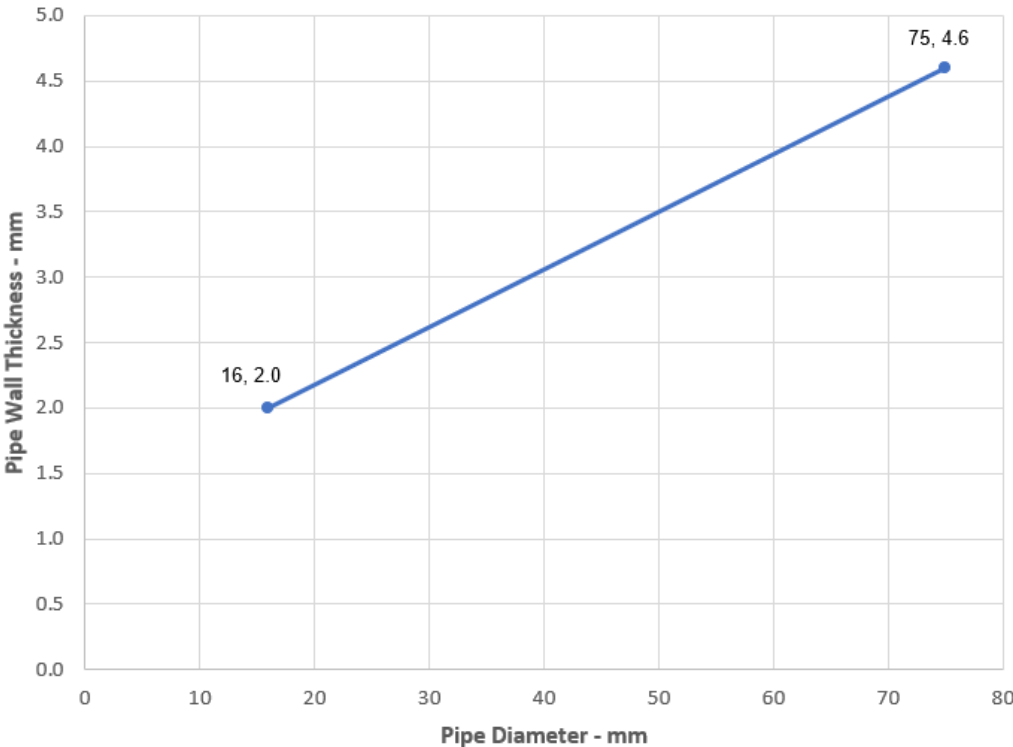

PVC-U Pipes - EI 60 U/C

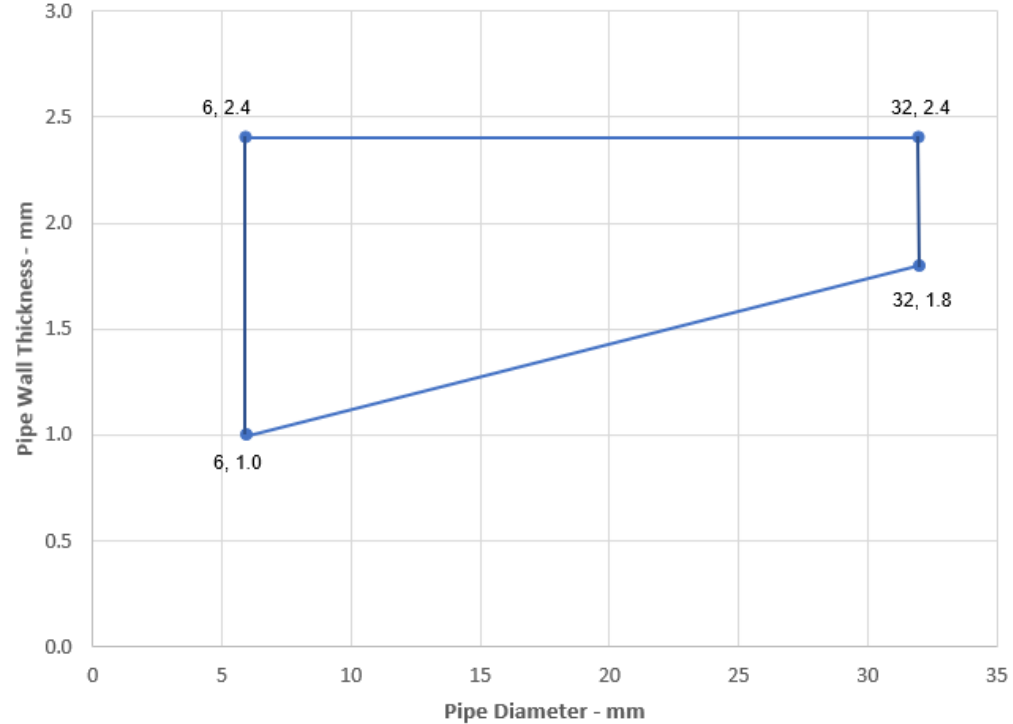

A.6.3 Pipe penetration seal with 2x Protecta FR Board 1-S

Penetration Seal: CS (Continuous Sustained) insulated metallic pipes fitted at any position within the aperture, with 50 mm Protecta FR Board 1-S to both sides of the wall. Minimum separation between penetration seals and seal edges of 30 mm. Protecta FR Pipes Wraps are required to be fitted around the pipe insulation.

Construction details:

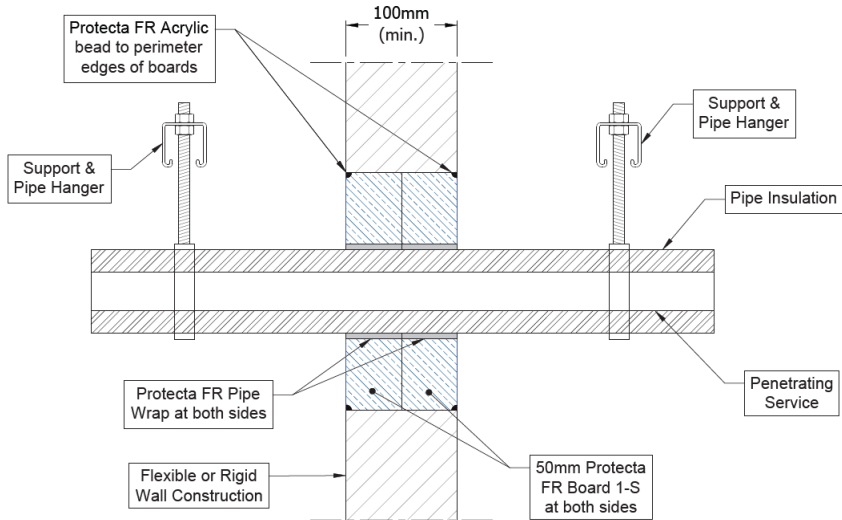

Configuration 1:

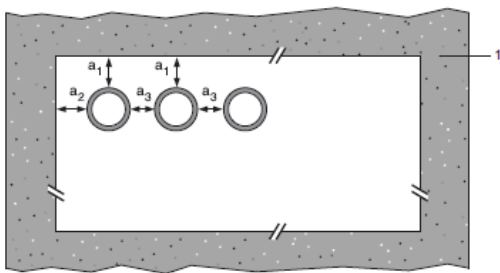

Configuration 2:

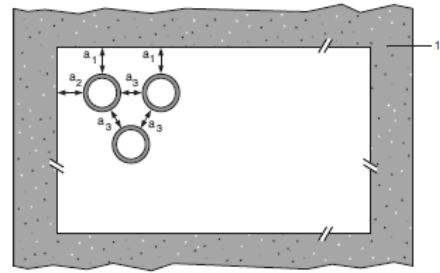

Key

- 1 Supporting construction
- a1 Pipe / top edge of seal separation
- a2 Pipe / side edge of seal separation
- a3 Pipe / pipe separation

A.6.3.1 Double side penetration seal with pipes

Services	Insulation	Protecta FR Wrap	Classification
Mild or stainless steel pipe	32-50 mm thick Elastomeric insulation minimum class B-s3, d0 or PE Foam insulation	3 layers 50 x 1.8 mm	EI 90 C/U
40 mm diameter/1-14.2 mm wall*			
50 mm diameter/1.2-14.2 mm wall*			
60 mm diameter/1.4-14.2 mm wall*			
75 mm diameter/1.6-14.2 mm wall*			
90 mm diameter/1.9-14.2 mm wall*			
100 mm diameter/2.1-14.2 mm wall*			
115 mm diameter/2.4-14.2 mm wall*			
140 mm diameter/2.9-14.2 mm wall*			
165 mm diameter/ 3.4-14.2 mm wall*			
180 mm diameter/ 3.6-14.2 mm wall*			
200 mm diameter/ 4.0-14.2 mm wall*			
219 mm diameter/ 4.3-14.2 mm wall*			
250 mm diameter/ 5.0-14.2 mm wall*			
300 mm diameter/ 5.9-14.2 mm wall*			
324 mm diameter/ 6.35-14.2 mm wall*			

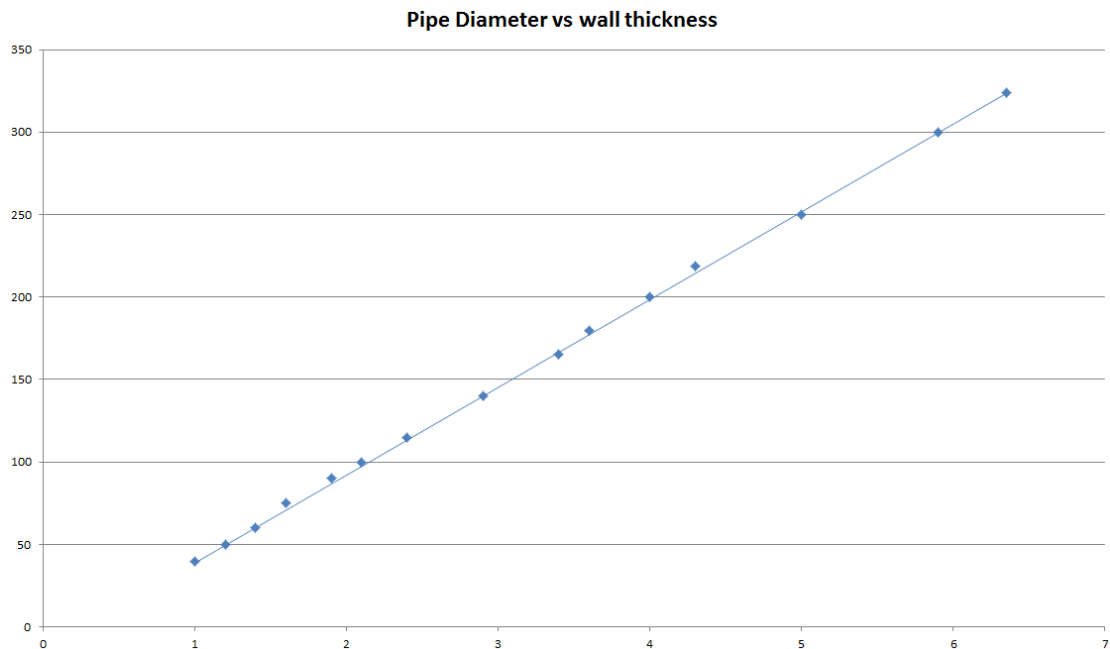

A.6.4 Pipe penetration seal with 2x Protecta FR Board 1-S

Penetration Seal: CS (Continuous Sustained) insulated metallic pipes fitted at any position within the aperture, with 50 mm Protecta FR Board 1-S to both sides of the wall. Protecta FR Pipes Wraps are required to be fitted around the pipe insulation.

Construction details:

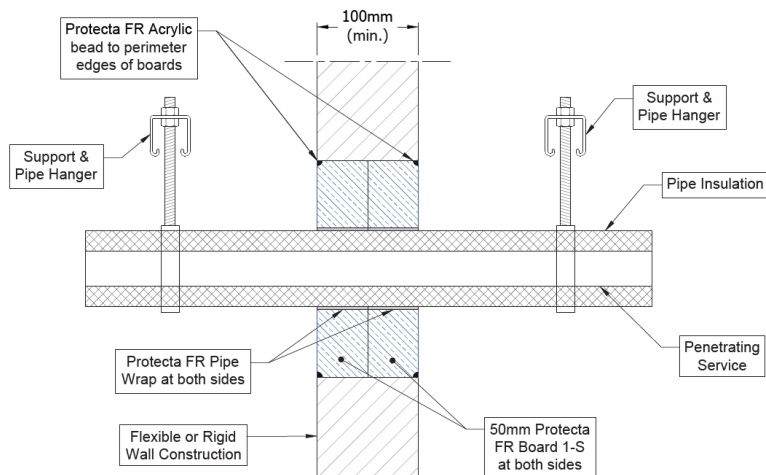
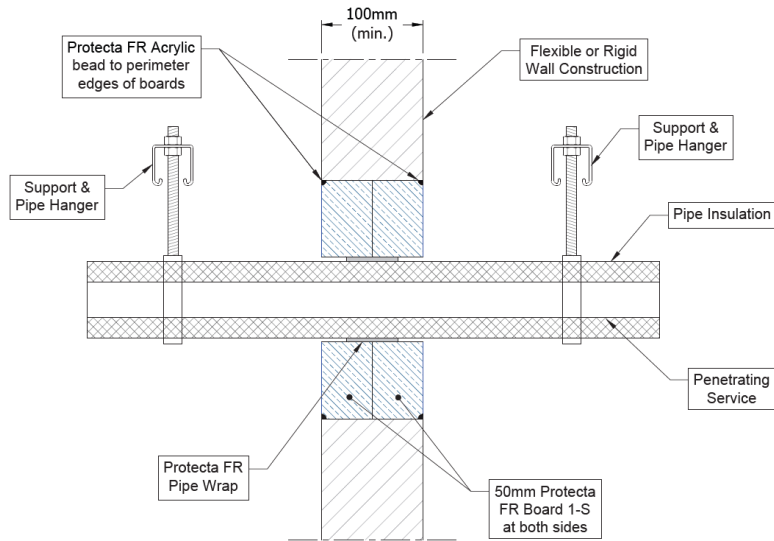

A.6.4.1 Two layer penetration seal with pipes

Services	Wrap	Insulation	Classification
Mild or stainless steel pipe			
Up to 40 mm diameter/1-14.2 mm wall	50 x 1.8 mm Protecta FR Pipe Wrap fitted centrally	13 mm elastomeric insulation minimum class B-s3, d0 or PE Foam insulation	EI 120 U/C, EI 120 U/U, EI 120 C/U, EI 120 C/C
Up to 40 mm diameter/1-14.2 mm wall*	2 off 50 x 3.6 mm Protecta FR Pipe Wrap, one fitted flush to each face of seal	13 – 32 mm elastomeric insulation minimum class B-s3, d0 or PE Foam insulation	E 120 U/C, E 120 U/U, E 120 C/U, E 120 C/C, EI 60 U/C, EI 60 U/U, EI 60 C/U, EI 60 C/C
50 mm diameter/1.3-14.2 mm wall*			
60 mm diameter/1.6-14.2 mm wall*			
75 mm diameter/2-14.2 mm wall*			
90 mm diameter/2.4-14.2 mm wall*			
100 mm diameter/2.7-14.2 mm wall*			
115 mm diameter/3.1-14.2 mm wall*			
140 mm diameter/3.8-14.2 mm wall*			
165 mm diameter/ 4.5-14.2 mm wall*			

* Typical pipe diameters shown, see below graph for intermediate sizes

Pipe diameter vs Wall thickness

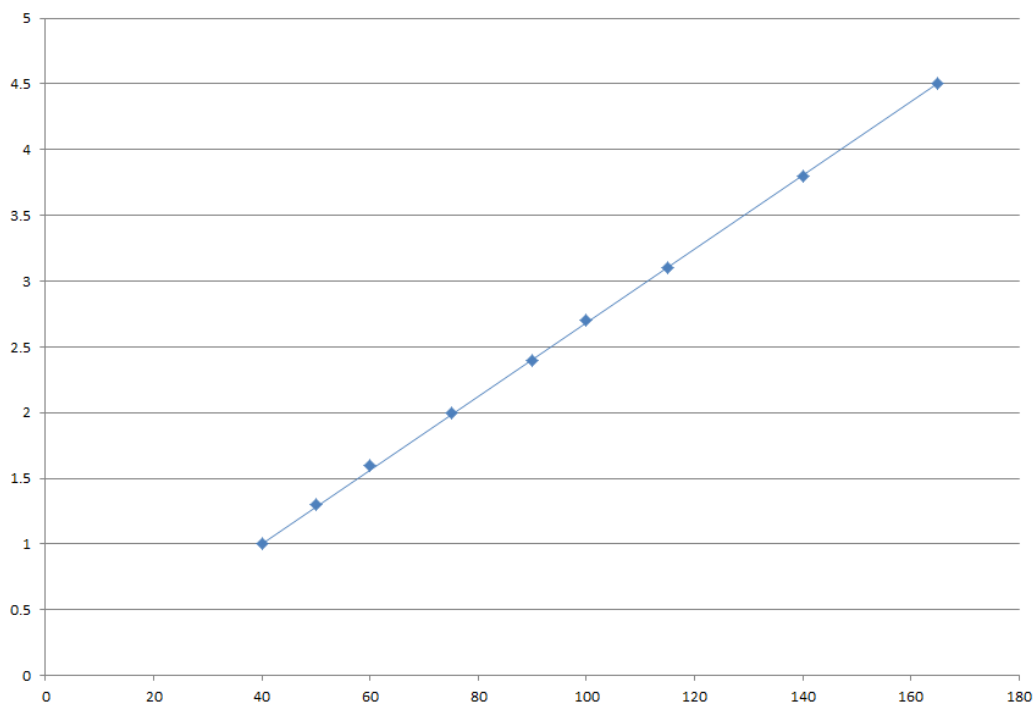

A.6.5 Pipe penetration seal with 2x Protecta FR Board 1-S

Penetration Seal: 500 mm (min.) LI (Local Interrupted) or CI (Continuous Interrupted) insulated or uninsulated metallic and composite pipes fitted at any position within the aperture, with 50 mm Protecta FR Board 1-S to both sides of the wall.

Construction details:

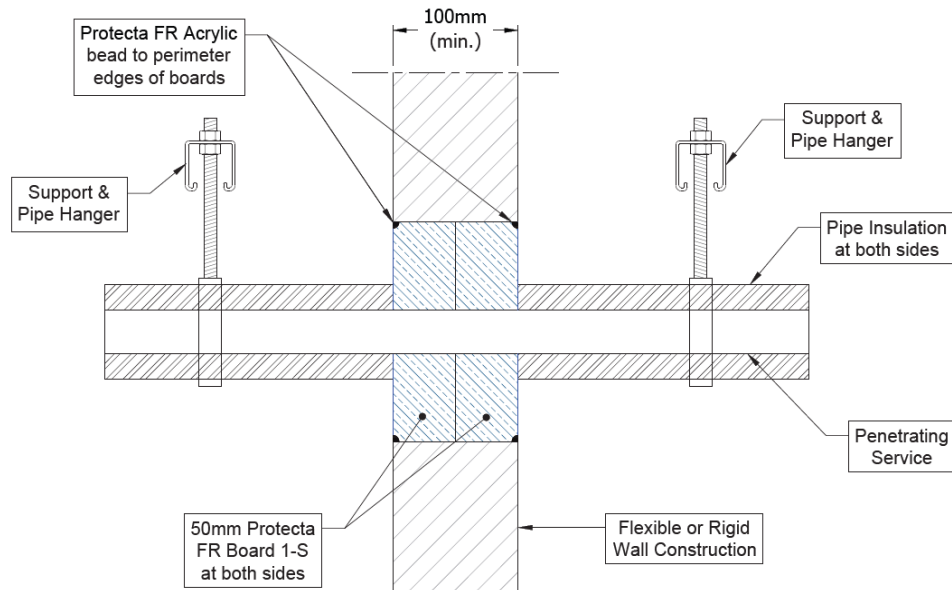

A.6.5.1 Two layer penetration seal with pipes

Services	Insulation (minimum thickness and density)	Classification
Copper or steel pipe up to 54 mm diameter/1-14.2 mm wall	20 mm stone wool 80 kg/m ³	EI 120 C/C
Copper or steel pipe up to 54 mm diameter/0.7-14.2 mm wall*	20 mm glass or stone wool 75 kg/m ³	E 90 C/C, EI 60 C/C
Copper or steel pipe up to 108 mm diameter/0.7-14.2 mm wall*	30 mm glass or stone wool 75 kg/m ³	E 120 C/C, EI 30 C/C
Mild or stainless steel pipe up to 273 mm diameter/1-14.2 mm wall*	30 mm glass or stone wool 75 kg/m ³	E 90 C/U, EI 60 C/U
Alupex pipe up to 75 mm diameter/2.75-4.7 mm wall*	25 mm glass or stone wool 75 kg/m ³	EI 30 C/C

Copper or Steel Pipes with Glass or Stone Wool Insulation - C/C

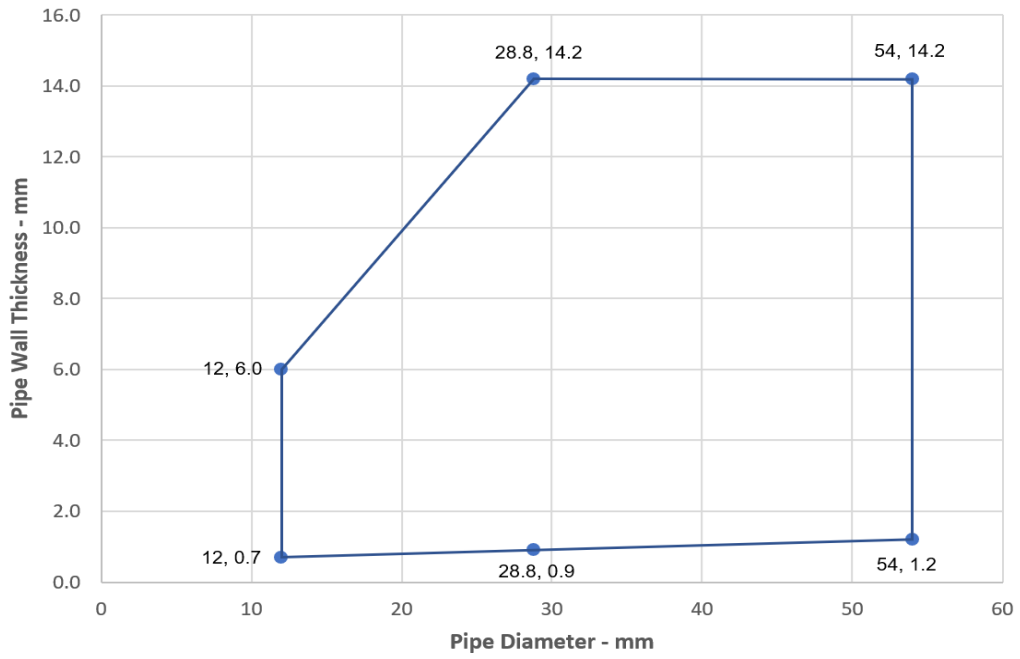

Copper or Steel Pipes with Glass or Stone Wool Insulation - C/C

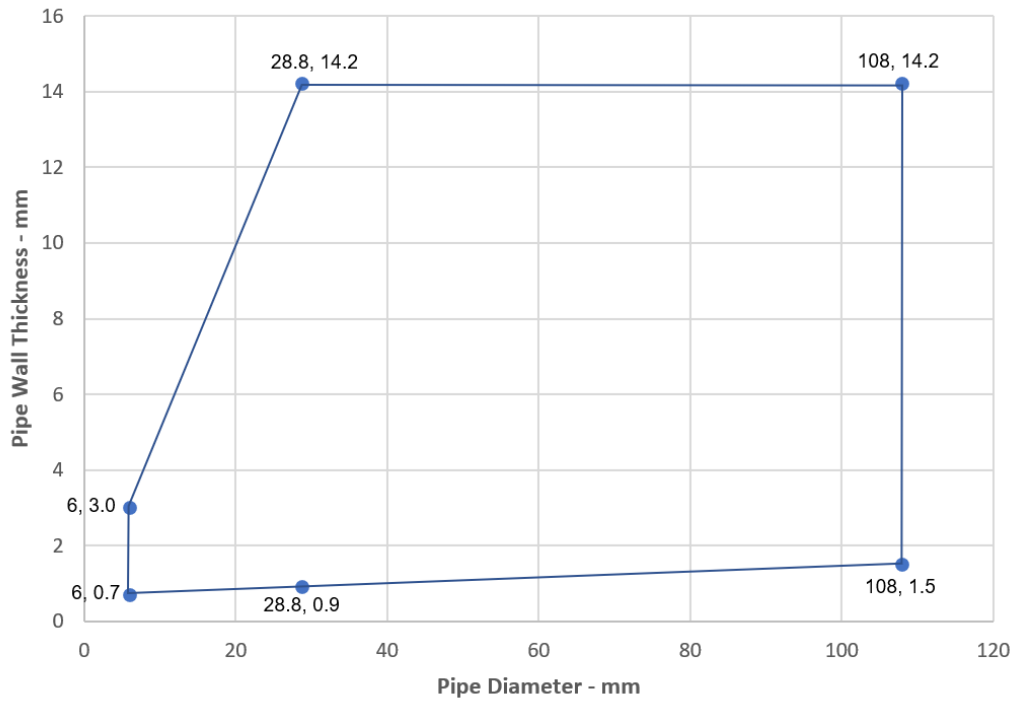

Steel Pipes with Glass or Stone Wool Insulation - C/U

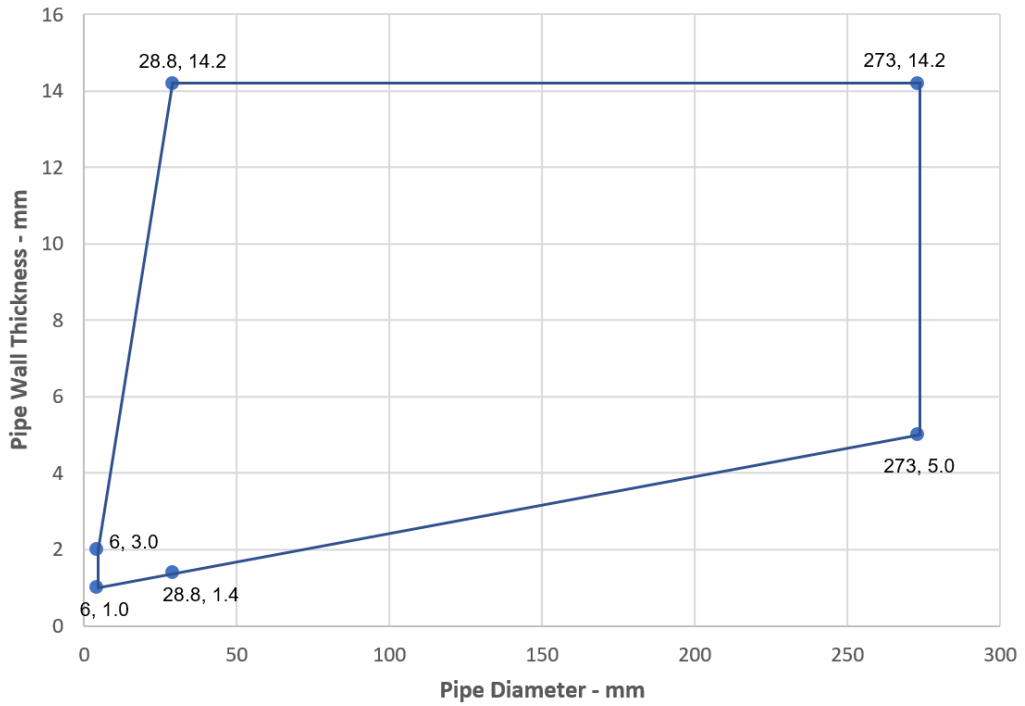

Alupex Pipes with Glass or Stone Wool Insulation - C/C

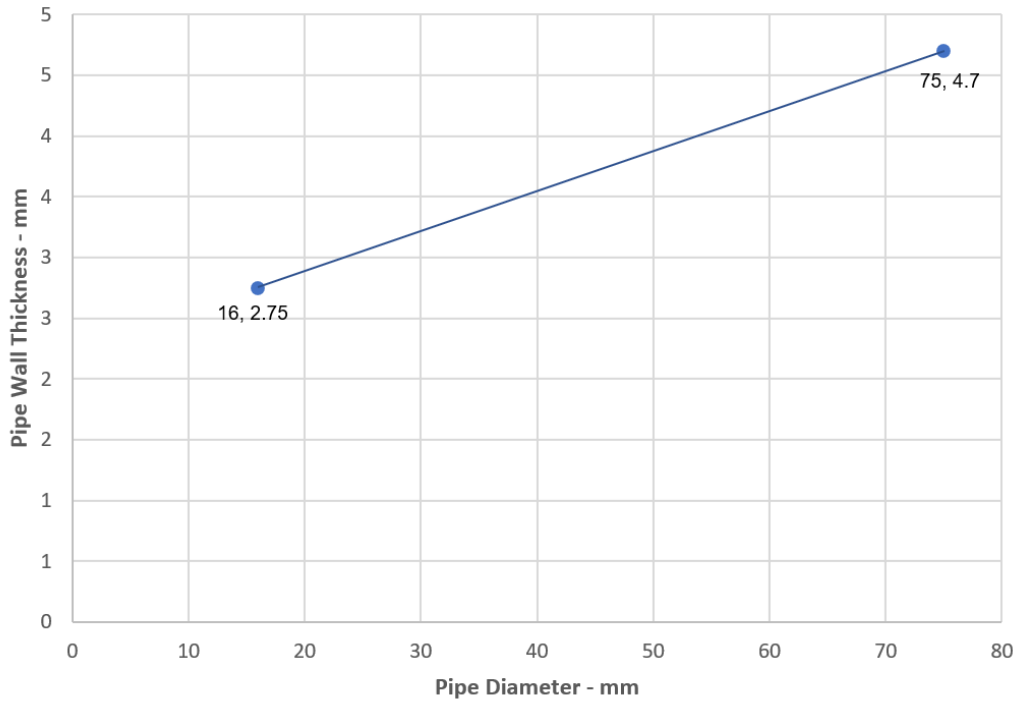

Services	Insulation (minimum thickness and density)	Classification
Mild or stainless steel pipe		
40 mm diameter/1-14.2 mm wall	20 mm stone wool 80 kg/m ³	EI 120 C/U
40 mm diameter/1-14.2 mm wall*	30 mm stone wool 80 kg/m ³	E 120 C/U, EI 90 C/U
50 mm diameter/1.2-14.2 mm wall*		
60 mm diameter/1.4-14.2 mm wall*		
75 mm diameter/1.7-14.2 mm wall*		
90 mm diameter/2-14.2 mm wall*		
100 mm diameter/2.2-14.2 mm wall*		
115 mm diameter/2.5-14.2 mm wall*		
140 mm diameter/3-14.2 mm wall*		
165 mm diameter/3.5-14.2 mm wall*		
180 mm diameter/3.8-14.2 mm wall*		
200 mm diameter/4.2-14.2 mm wall*		
219 mm diameter/4.5-14.2 mm wall*		

* Typical pipe diameters shown, see below graph for intermediate sizes

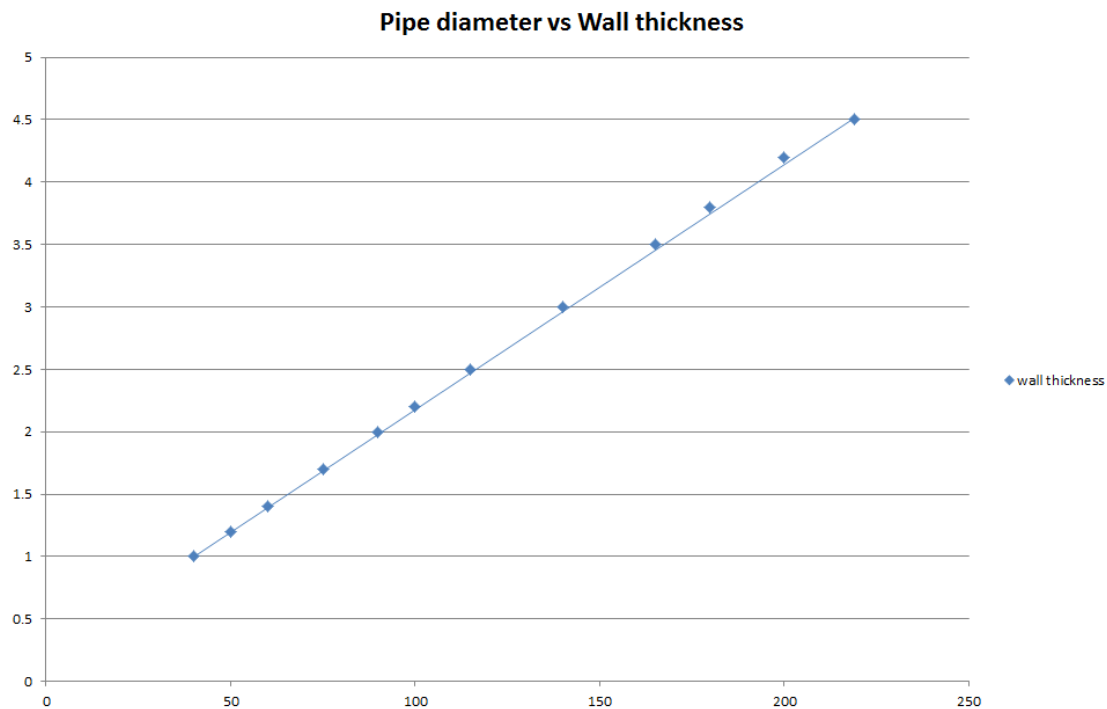

Services	Insulation (minimum thickness and density)	Classification
Alupex pipe	20 mm stone wool 80 kg/m ³	EI 120 C/C
16 mm diameter/2.25 mm wall		EI 60 C/C
20 mm diameter/2.5 mm wall		
26 mm diameter/3 mm wall		
32 mm diameter/3 mm wall		
40 mm diameter/3.5 mm wall		
50 mm diameter/4 mm wall		
63 mm diameter/4.5 mm wall		
75 mm diameter/4.7 mm wall		

A.6.6 Pipe penetration seal with 2x Protecta FR Board 1-S

Penetration Seal: LS (Local Sustained) or CS (Continuous Sustained) insulated metallic and composite pipes fitted at any position within the aperture, with 50 mm Protecta FR Board 1-S to both sides of the wall. Protecta FR Pipes Wraps are required to be fitted around the pipe to both sides of the seal.

Construction details:

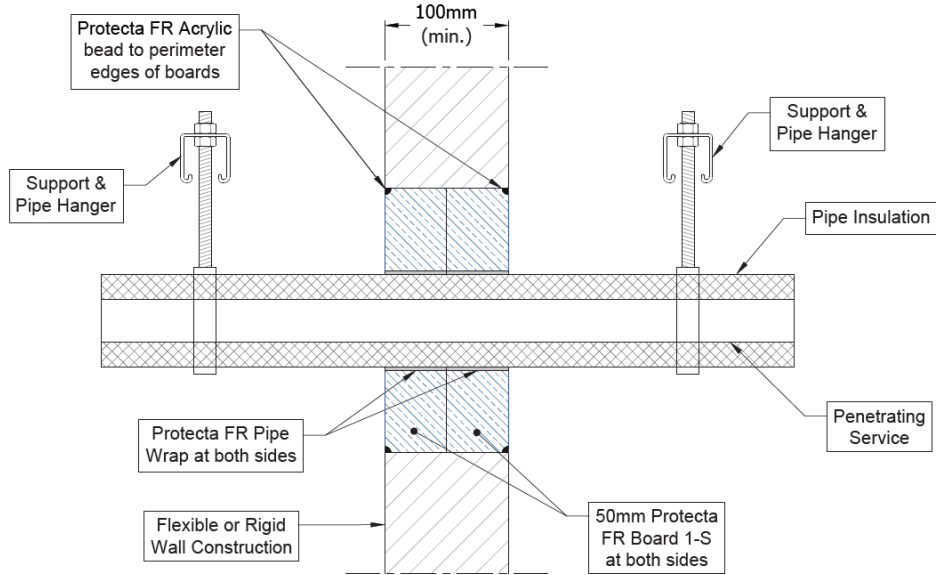

A.6.6.1 Two layer penetration seal with pipes

Services	Wrap	Insulation	Classification
Mild or stainless steel pipe	50 x 1.8 mm Protecta FR Pipe Wrap fitted to both sides of the seal	15 mm phenolic foam insulation (CS)	EI 90 C/U
16 mm diameter/1.0 mm wall		25-100 mm phenolic foam insulation (CS)	
16-273 mm diameter/1.0-14.2 mm wall*			

Steel Pipes with Phenolic Foam Insulation - C/U

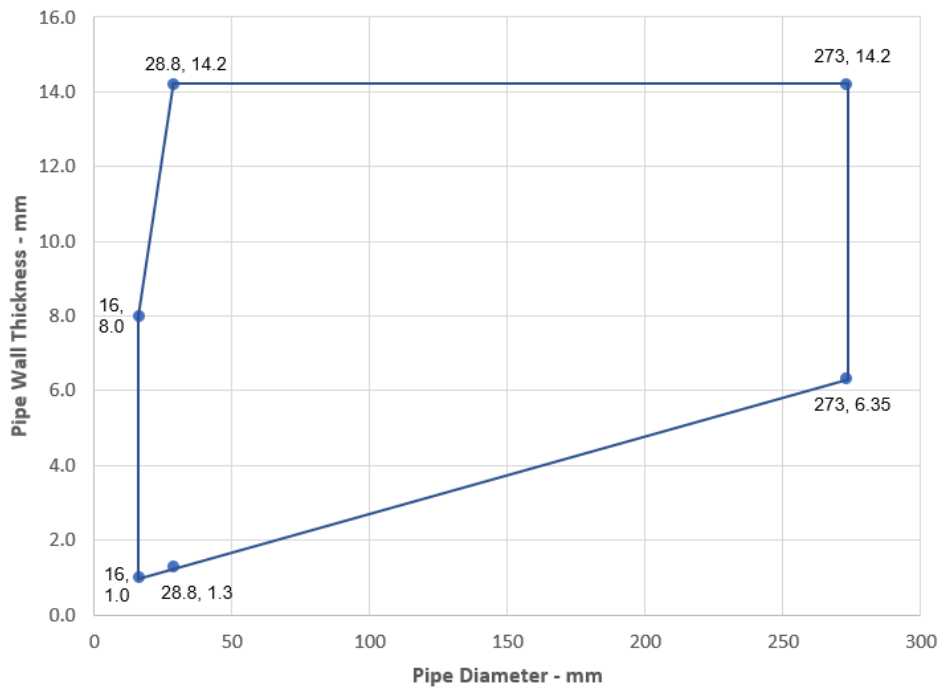

Services	Wrap	Insulation	Classification
Copper and steel pipe			
12 mm diameter/1 mm wall	50 x 3.6 mm Protecta FR Pipe Wrap fitted to both sides of the seal	9 mm elastomeric insulation minimum class B-s3, d0 or PE Foam insulation (LS and CS)	EI 120 C/C
12-54 mm diameter/1-1.2 mm wall		9-13 mm elastomeric insulation minimum class B-s3, d0 or PE Foam insulation (LS and CS)	E 120 C/C, EI 90 C/C
6-54 mm diameter/0.7-1.2 mm wall		13-25 mm elastomeric insulation minimum class B-s3, d0 or PE Foam insulation (LS and CS)	E 120 C/C, EI 60 C/C
15 mm diameter/0.7 mm wall	50 x 1.8 mm Protecta FR Pipe Wrap fitted to both sides of the seal	15 mm phenolic insulation (CS)	E 120 C/C, EI 90 C/C
6-159 mm diameter/0.7-14.2 mm wall*		100 mm phenolic insulation (CS)	EI 60 C/C
6-159 mm diameter/0.7-14.2 mm wall*		15 mm phenolic insulation (CS)	E 120 C/C, EI 30 C/C
6-159 mm diameter/0.7-14.2 mm wall*		16-99 mm phenolic insulation (CS)	E 60 C/C, EI 30 C/C
6-54 mm diameter/0.7-14.2 mm wall*	50 x 3.6 mm Protecta FR Pipe Wrap fitted to both sides of the seal	40 mm PU foam insulation (CS)	E 120 C/C, EI 60 C/C

*See below graph for interpolation pipe sizes

Copper or Steel Pipes with Phenolic Foam Insulation - C/C

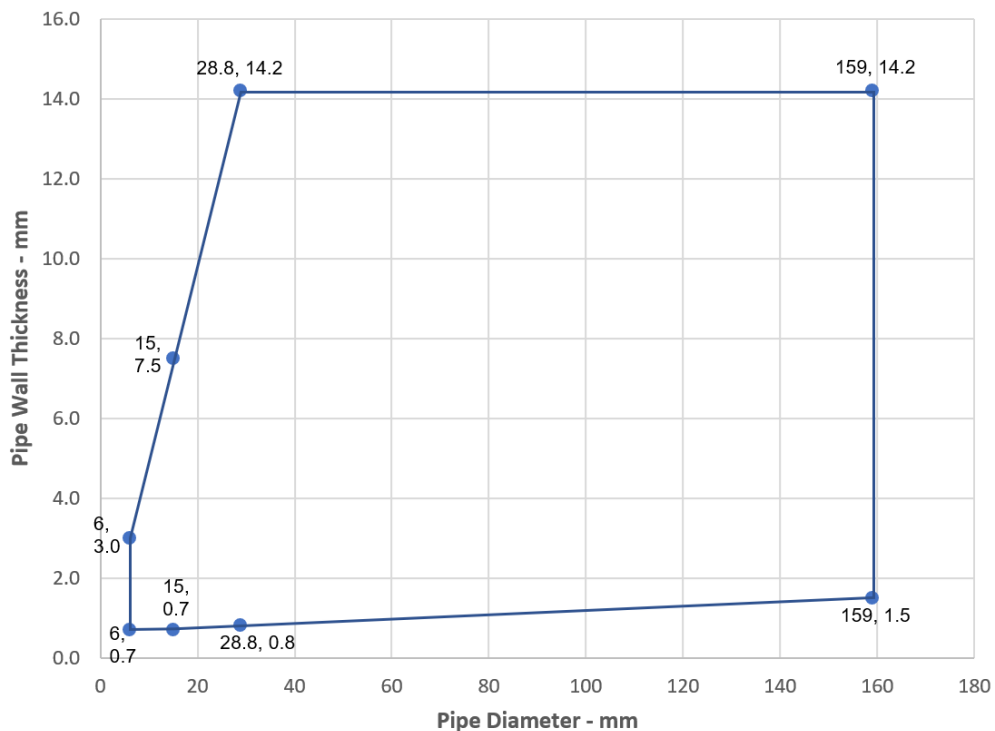

Copper or Steel Pipes with Phenolic Foam Insulation - C/C

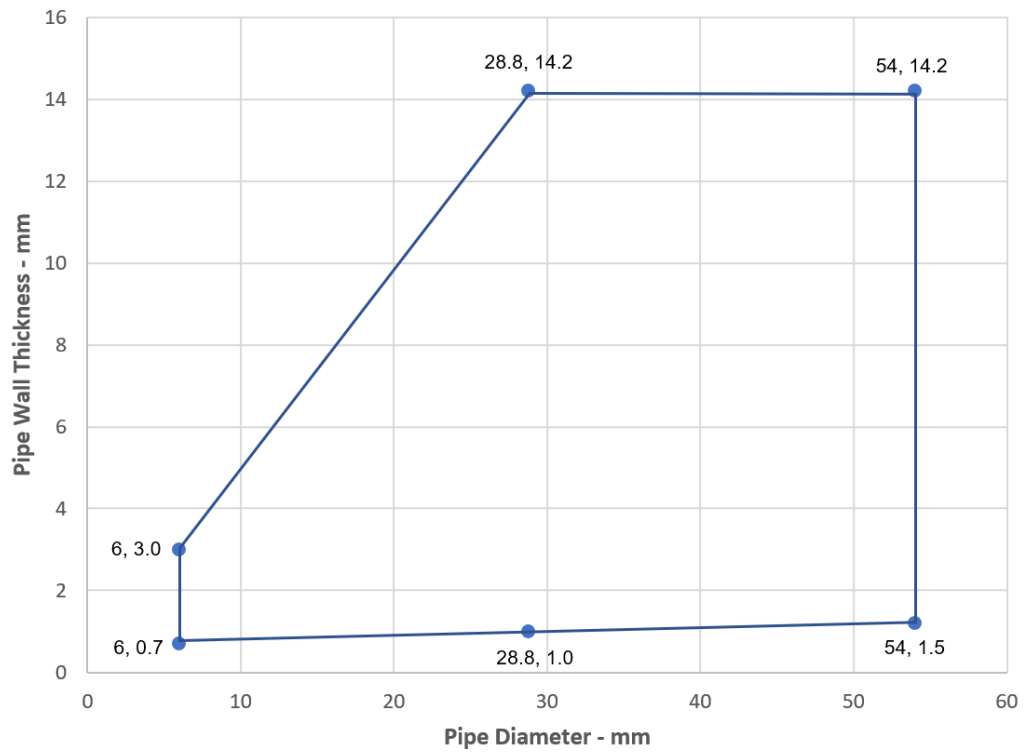

Services		Wrap	Insulation	Classification
Alupex pipe				
16 mm diameter/2.25 mm wall		50 x 3.6 mm Protecta FR Pipe Wrap fitted to both sides of the seal	9-25 mm elastomeric insulation minimum class B-s3, d0 or PE Foam insulation	EI 120 C/C
20 mm diameter/2.5 mm wall				
26 mm diameter/3 mm wall				
32 mm diameter/3 mm wall				
40 mm diameter/3.5 mm wall				
50 mm diameter/4 mm wall				
63 mm diameter/4.5 mm wall				
75 mm diameter/4.7 mm wall				
25 mm diameter/2.5 mm wall			13 mm polyethylene foam with plastic sheaving	E 90 C/C, EI 60 C/C
PE pipe according to EN 1519-1, EN 12201-2 and EN 12006-1, ABS according to EN 1455-1 and pipes made from SAN+PVC according to EN 1565-1				
Maximum 160 mm diameter pipe*	Maximum 68 mm diameter	50 x 3.6 mm Protecta FR Pipe Wrap fitted to both sides of the seal	9-50 mm Elastomeric insulation minimum class B-s3, d0 or PE Foam insulation	EI 60 C/C
	Maximum 178 mm diameter	50 x 10.8 mm Protecta FR Pipe Wrap fitted to both sides of the seal		
	Maximum 260 mm diameter	50 x 18.0 mm Protecta FR Pipe Wrap fitted to both sides of the seal		
PP pipe according to EN 1852-1: 2009				
Maximum 160 mm diameter pipe*	Maximum 68 mm diameter	50 x 3.6 mm Protecta FR Pipe Wrap fitted to both sides of the seal	9-50 mm Elastomeric insulation minimum class B-s3, d0 or PE Foam insulation	EI 60 C/C
	Maximum 178 mm diameter	50 x 10.8 mm Protecta FR Pipe Wrap fitted to both sides of the seal		
	Maximum 260 mm diameter	50 x 18.0 mm Protecta FR Pipe Wrap fitted to both sides of the seal		

*See below graph for interpolation pipe sizes

PE Pipes - EI 60 C/C

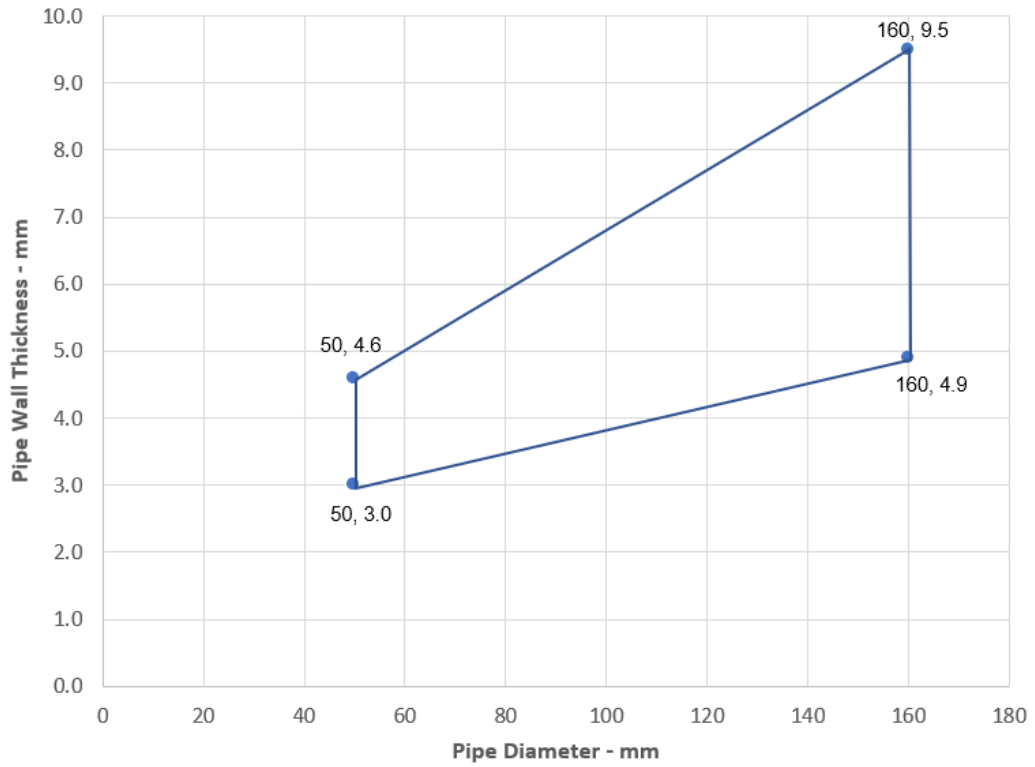

PP Pipes - EI 60 C/C

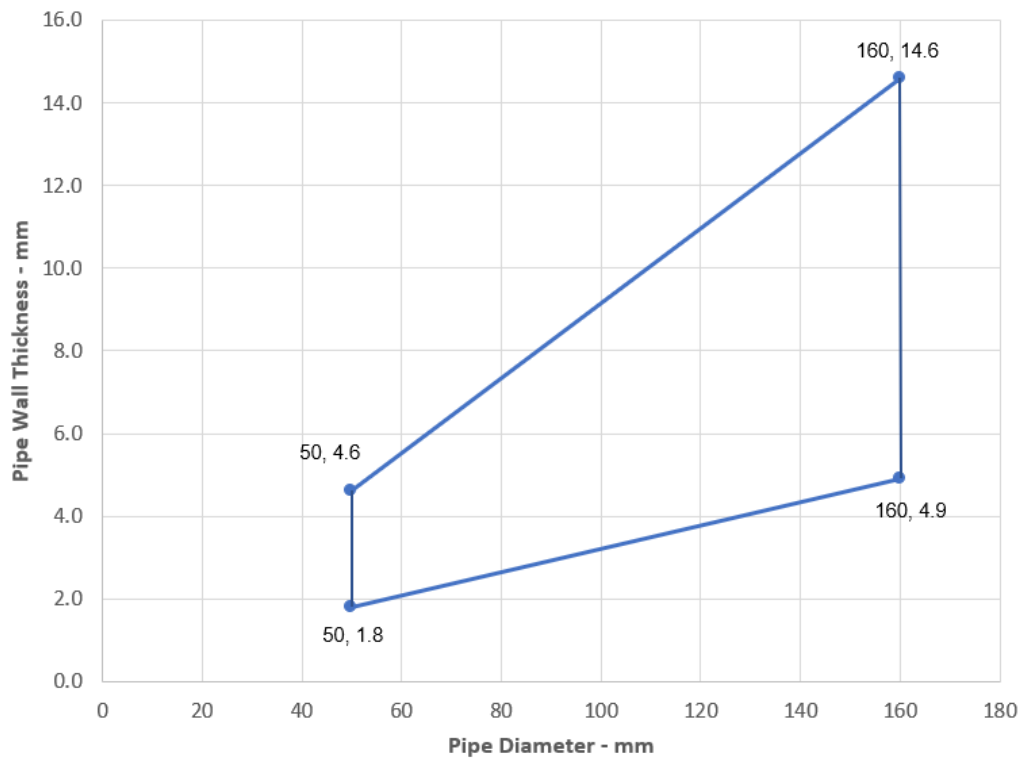

A.6.7 Protecta FR Pipe Wrap penetration seal for plastic pipes, in 2x Protecta FR Board 1-S, in flexible or rigid walls

Penetration Seal: Combustible pipes sealed with Protecta FR Pipe Wrap, to both sides of the wall. Minimum separation between penetration seals and seal edges of 30 mm. (Configuration 1 & 2).

Construction details:

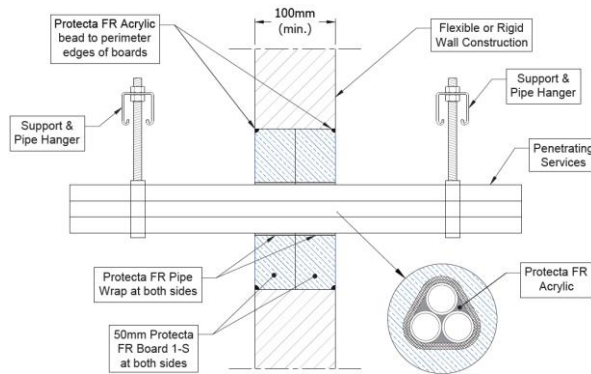
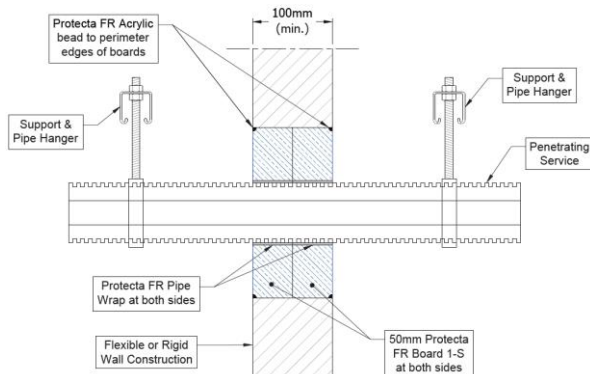
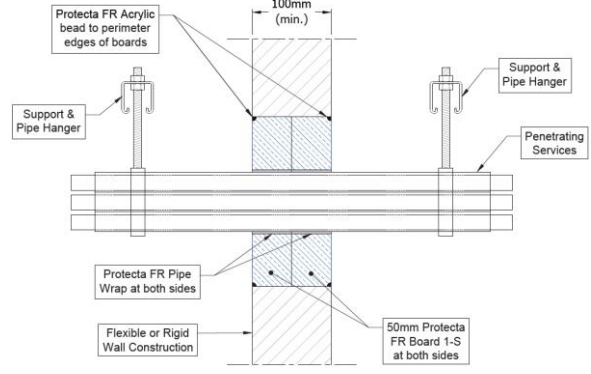
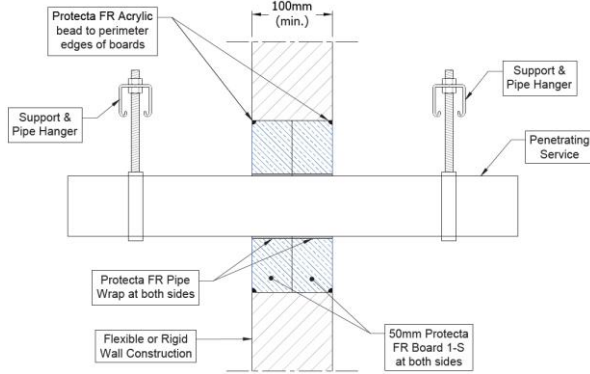

Configuration 1:

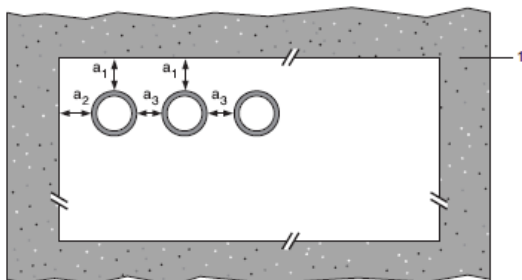

Configuration 2:

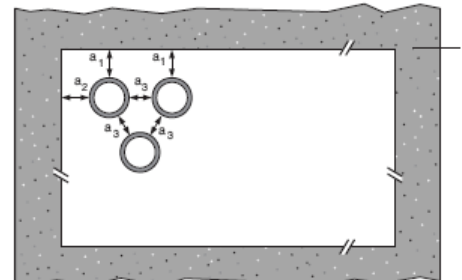

Key

- 1 Supporting construction
- a1 Pipe / top edge of seal separation
- a2 Pipe / side edge of seal separation
- a3 Pipe / pipe separation

A.6.7.1

Services	Wraps (both sides)	Permitted configuration for seal separation	Classification
PVC-U pipe according to EN 1329-1, EN 1452-2 and EN 1453-1 and PVC-C according to EN 1566-1			
Diameter up to 40 mm, wall thickness 1.9 – 3.0 mm	50 x 1.8 mm (1 layer)	1 & 2	EI 120 U/U, EI 120 C/U, EI 120 U/C, EI 120 C/C
Diameter up to 110 mm, wall thickness 2.7 - 6.6 mm	50 x 3.6 mm (2 x 1.8 layer)		E 120 U/C, E 120 C/C EI 90 U/C, EI 90 C/C
Diameter up to 125 mm, wall thickness 3.7 – 7.4 mm	50 x 5.4 mm (3 x 1.8 layer)		
Diameter up to 160 mm, wall thickness 9.5 mm *	50 x 7.2 mm (4 x 1.8 layer)		E 90 U/C, E 90 C/C EI 60 U/C, EI 60 C/C
Diameter up to 160 mm, wall thickness 4.0-9.5 mm *	50 x 10.8 mm (6 x 1.8 layer)		
Diameter up to 200 mm, wall thickness 4.9-11.9 mm	50 x 10.8 mm (6 x 1.8 layer)		EI 90 C/C
Diameter up to 315 mm, wall thickness 7.7-12.1 mm*	50 x 18 mm (10 x 1.8 layers)		EI 90 C/C
Diameter up to 400 mm, wall thickness 9.8-15.3 mm*	50 x 28.8 mm (16 x 1.8 layers)		EI 90 C/C
Diameter up to 110 mm, wall thickness 2.7–6.6 mm, fully or partially filled conduits with cables up to 14 mm diameter	50 x 3.6 mm (2 x 1.8 layers)		E 120 U/C, EI 90 U/C
Diameter up to 32 mm Ø, wall thickness 1.5-2.4 mm with or without cables up to 14 mm Ø, in pipe bundles up to 110 mm Ø ¹⁾	50 x 3.6 mm (2 x 1.8 layers)		EI 90 U/C
PE pipe according to EN 1519-1, EN 12201-2 and EN 12006-1, ABS according to EN 1455-1 and pipes made from SAN+PVC according to EN 1565-1			
Diameter up to 40 mm, wall thickness 2.4 – 3.7 mm	50 x 1.8 mm (1 layer)	1 & 2	EI 120 U/U, EI 120 C/U, EI 120 U/C, EI 120 C/C
Diameter up to 110 mm, wall thickness 4.2 - 10 mm	50 x 3.6 mm (2 x 1.8 layer)		E 120 U/C, E 120 C/C EI 90 U/C, EI 90 C/C
Diameter up to 125 mm, wall thickness 4.8 – 12 mm	50 x 5.4 mm (3 x 1.8 layer)		
Diameter up to 160 mm, wall thickness 14.6 mm	50 x 7.2 mm (4 x 1.8 layer)		E 90 U/C, E 90 C/C EI 60 U/C, EI 60 C/C
Diameter up to 160 mm, wall thickness 4.9-14.6 mm	50 x 10.8 mm (6 x 1.8 layer)		
Diameter up to 200 mm, wall thickness 6.2-18.2 mm	50 x 10.8 mm (6 x 1.8 layer)		EI 90 C/C
Diameter up to 315 mm, wall thickness 18.7 mm	50 x 18 mm (10 x 1.8 layers)		EI 60 C/C
Diameter up to 400 mm, wall thickness 23.7 mm	50 x 28.8 mm (16 x 1.8 layers)		EI 60 C/C
Diameter up to 110 mm, wall thickness 4.2–10 mm, fully or partially filled conduits with cables up to 14 mm diameter	50 x 3.6 mm (2 x 1.8 layers)		E 120 U/C, EI 90 U/C
Diameter up to 40 mm Ø, wall thickness 2.0-3.7 mm with or without cables up to 14 mm Ø, in pipe bundles up to 110 mm Ø ¹⁾	50 x 3.6 mm (2 x 1.8 layers)		EI 90 U/C

Services	Wraps (both sides)	Permitted configuration for seal separation	Classification
PP pipe according to EN 1852-1: 2009			
Diameter up to 40 mm, wall thickness 1.8 – 5.5 mm	50 x 1.8 mm (1 layer)	1 & 2	EI 120 U/U, EI 120 C/U, EI 120 U/C, EI 120 C/C
Diameter up to 110 mm, wall thickness 2.7 - 15.1 mm	50 x 3.6 mm (2 x 1.8 layer)		EI 90 U/U, EI 90 C/U, EI 90 U/C, EI 90 C/C
Diameter up to 125 mm, wall thickness 3.1 – 17.1 mm	50 x 5.4 mm (3 x 1.8 layer)		E 120 U/C, E 120 C/C EI 90 U/C, EI 90 C/C
Diameter up to 160 mm, wall thickness 21.9 mm	50 x 7.2 mm (4 x 1.8 layer)		EI 60 U/C, EI 60 C/C
Diameter up to 160 mm, wall thickness 4.9-21.9 mm	50 x 10.8 mm (6 x 1.8 layer)		EI 90 C/C
Diameter up to 200 mm, wall thickness 4.9-18.2 mm	50 x 10.8 mm (6 x 1.8 layer)		EI 60 C/C
Diameter up to 315 mm, wall thickness 28.6 mm	50 x 18 mm (10 x 1.8 layers)		E 120 U/C, EI 90 U/C
Diameter up to 110 mm, wall thickness 2.7–15.1 mm, fully or partially filled conduits with cables up to 14 mm diameter	50 x 3.6 mm (2 x 1.8 layers)		EI 90 U/C
Diameter up to 40 mm \varnothing , wall thickness 1.8-2.0 mm with or without cables up to 14 mm \varnothing , in pipe bundles up to 110 mm \varnothing ¹⁾	50 x 3.6 mm (2 x 1.8 layers)		

¹⁾ PVC, PE and PP pipes can be mixed in the same bundle.

Services	Wraps (both sides)	Permitted configuration for seal separation	Classification
Uponor Wirsbo PEX double pipe in pipe system according to ISO 15875			
Diameter up to 54 mm/4.0 mm wall thickness (outer pipe), 28 mm diameter/0.4 mm wall thickness (inner pipe)	50 x 3.6 mm (2 x 1.8 layers)	1 & 2	EI 120 C/C
Diameter up to 25 mm pipes, wall thickness 0.6 mm, in bundles up to 50 mm	50 x 3.6 mm (2 x 1.8 layers)		EI 90 C/C
Uponor Decibel pipe according to EN 1451-1			
50 mm diameter/2.0 mm wall thickness	50 x 3.6 mm (2 x 1.8 layers)	1 & 2	EI 90 U/U
75-110 mm diameter/2.6-3.8 mm wall thickness	50 x 3.6 mm (2 x 1.8 layers)		EI 90 U/C
BluePower Multilayer pipe according to EN 1451-1			
32-50 mm diameter/1.8 mm wall thickness*	50 x 3.6 mm (2 x 1.8 layers)	1 & 2	EI 90 U/U
75-110 mm diameter/3.4 mm wall thickness*	50 x 3.6 mm (2 x 1.8 layers)		EI 90 C/U
125-160 mm diameter/3.9-4.9 mm wall thickness	50 x 10.8 mm (6 x 1.8 layers)		EI 90 U/C

Services	Wraps (both sides)	Permitted configuration for seal separation	Classification
Rehau Raupiano Plus PP-DD according to DIN 4102			
40-50 mm diameter/1.8-2.7 mm wall thickness*	50 x 3.6 mm (2 x 1.8 layers)	1 & 2	EI 120 U/U
75-110 mm diameter/2.7 mm wall thickness*	50 x 3.6 mm (2 x 1.8 layers)		EI 120 U/C
125 mm diameter/3.9 mm wall thickness	50 x 7.2 mm (4 x 1.8 layers)		EI 120 U/C
160 mm diameter/3.9 mm wall thickness	50 x 10.8 mm (6 x 1.8 layers)		EI 120 U/C
Polo-Kal NG Poloplast PP-MV according to DIN 4102			
32-50 mm diameter/2.0-3.4 mm wall thickness*	50 x 3.6 mm (2 x 1.8 layers)	1 & 2	EI 120 U/U
75-110 mm diameter/3.4 mm wall thickness*	50 x 3.6 mm (2 x 1.8 layers)		EI 120 U/C
125 mm diameter/3.9 mm wall thickness	50 x 7.2 mm (4 x 1.8 layers)		EI 120 U/C
160 mm diameter/4.9 mm wall thickness	50 x 10.8 mm (6 x 1.8 layers)		EI 120 U/C
Aquatherm Green SDR9 MF PP-RP according to ISO 21003			
32 mm diameter/3.0 mm wall thickness	50 x 1.8 mm (1 x 1.8 layer)	1 & 2	E 120 C/C, EI 90 C/C
40-50 mm diameter/5.6-12.3 mm wall thickness*	50 x 3.6 mm (2 x 1.8 layers)		E 120 C/C, EI 90 C/C
63-110 mm diameter/12.3 mm wall thickness*	50 x 3.6 mm (2 x 1.8 layers)		E 120 C/C, EI 90 C/C
Wavin SiTech + PP-M B according to EN 13501-1			
32-50 mm diameter/1.8-3.4 mm wall thickness*	50 x 3.6 mm (2 x 1.8 layers)	1 & 2	E 120 U/U, EI 90 U/U
75-110 mm diameter/3.4 mm wall thickness*	50 x 3.6 mm (2 x 1.8 layers)		E 120 U/C, EI 60 U/C
Wavin AS+ pipes according to EN 12056 and DIN 1986-100			
32-50 mm diameter*	50 x 3.6 mm (2 x 1.8 layers)	1 & 2	E 120 U/C, EI 90 U/C
75-110 mm diameter*	50 x 3.6 mm (2 x 1.8 layers)		E 120 U/C, EI 90 U/C
160-200 mm diameter*	50 x 10.8 mm (6 x 1.8 layers)		EI 90 C/C
Gilbert Silent PP according to DIN 4102			
32-50 mm diameter*	50 x 3.6 mm (2 x 1.8 layers)	1 & 2	EI 120 U/U
75-110 mm diameter*	50 x 3.6 mm (2 x 1.8 layers)		EI 120 U/C
125-160 mm diameter*	50 x 10.8 mm (6 x 1.8 layers)		EI 90 U/C

*See below graph for interpolation pipe sizes

PVC-U Pipes - E 90 C/C, EI 60 C/C

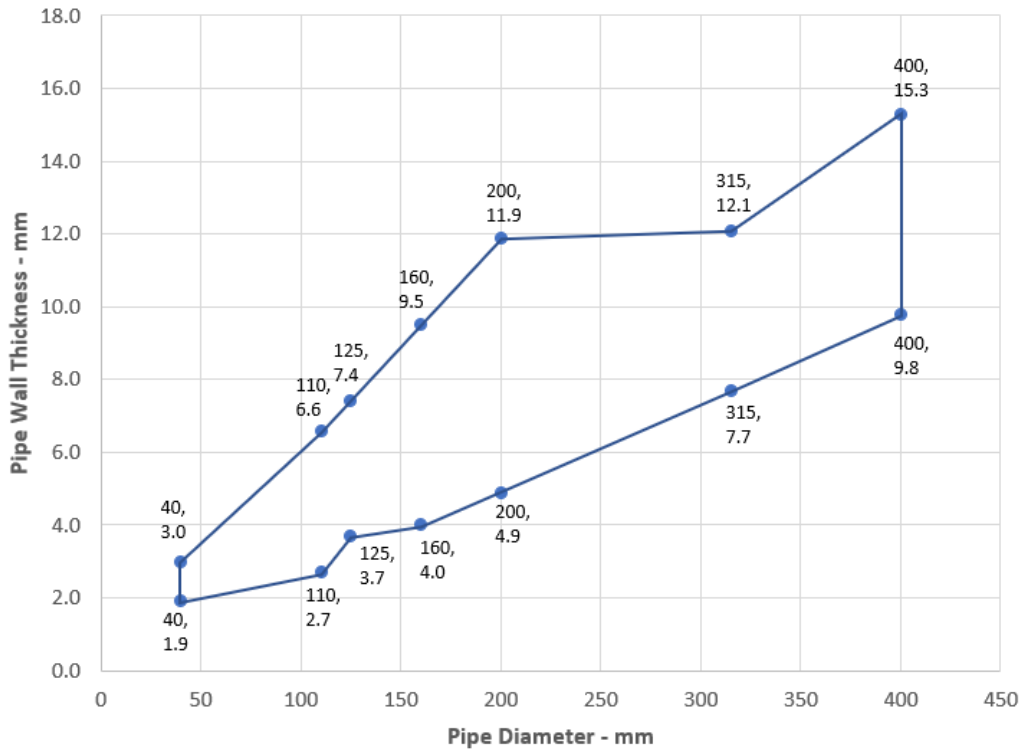

BluePower Pipes - EI 90 U/C

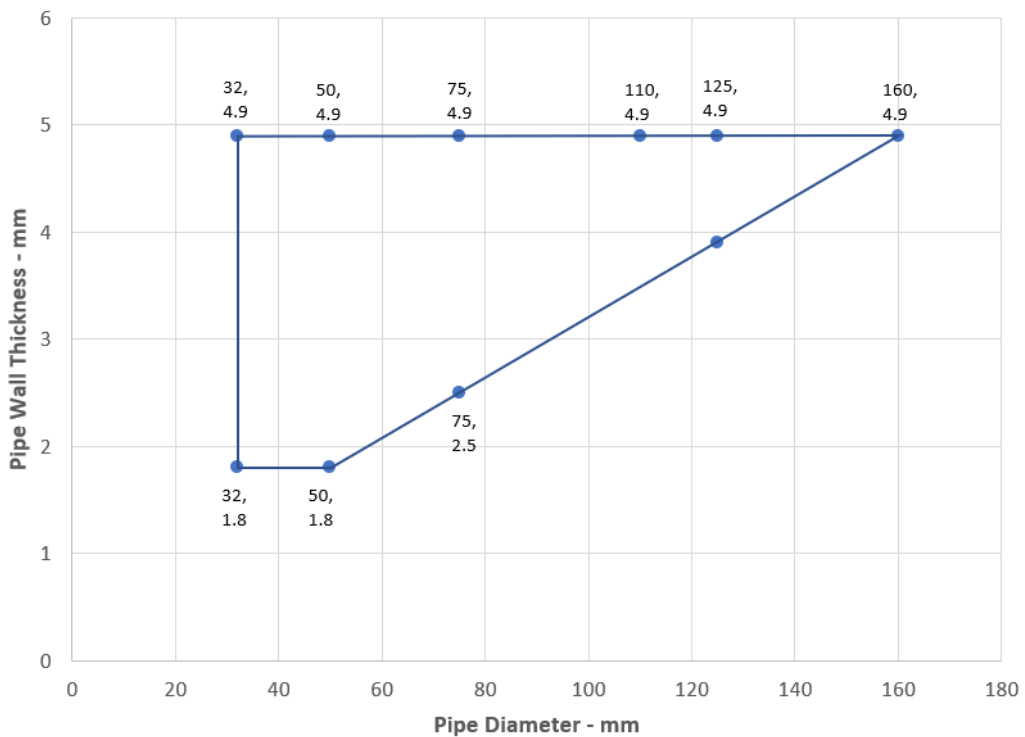

Rehau Raupiano Plus -EI 120 U/C

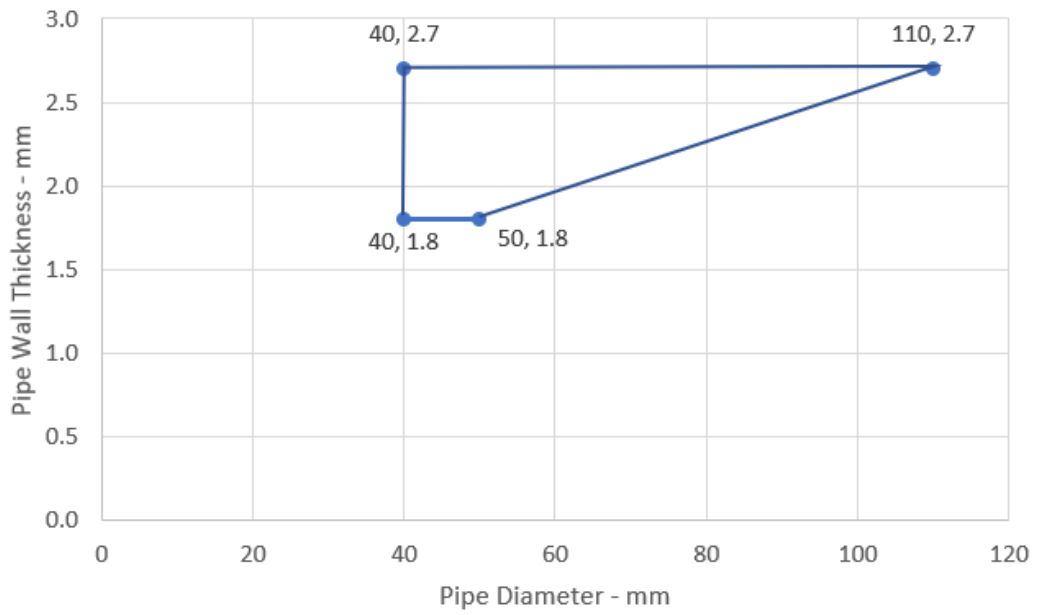

Polo-Kal NG - EI 120 U/C

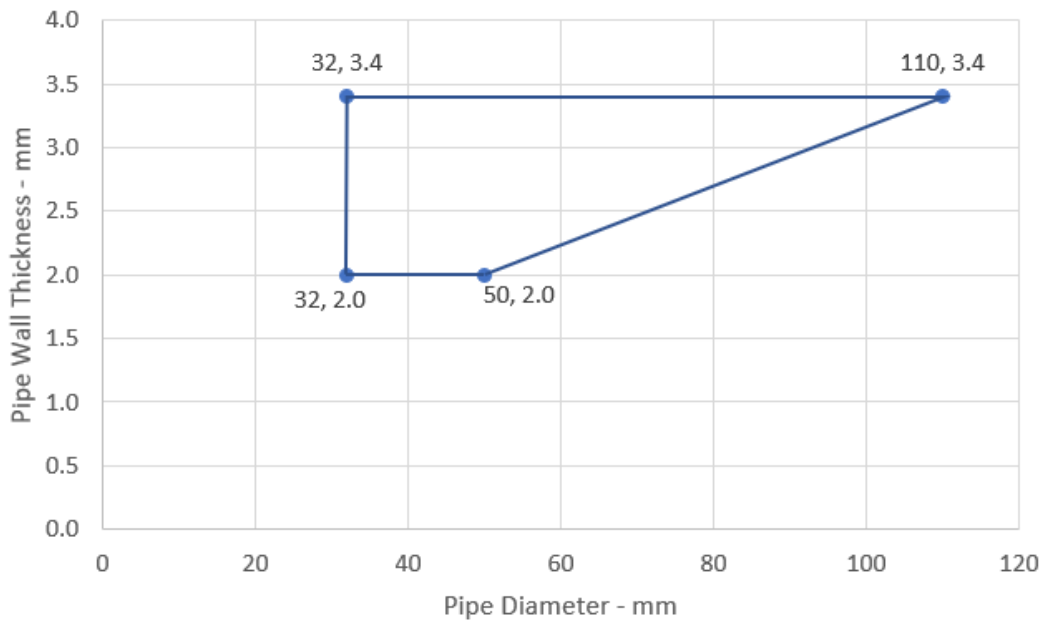

Aquatherm Green - E 120 C/C, EI 90 C/C

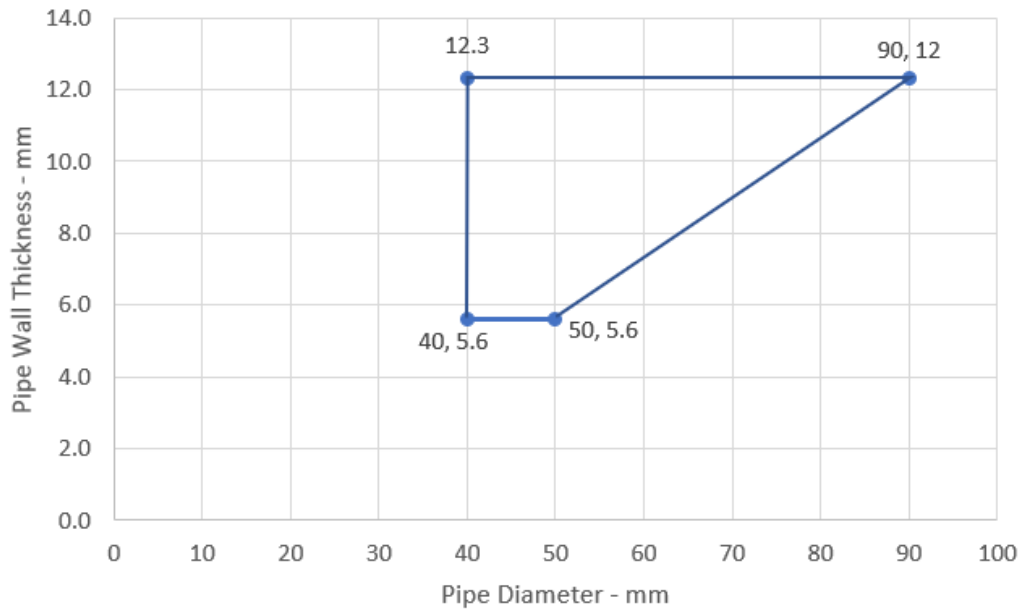

Wavin SiTech Pipes - E120 C/C, EI 60 C/C

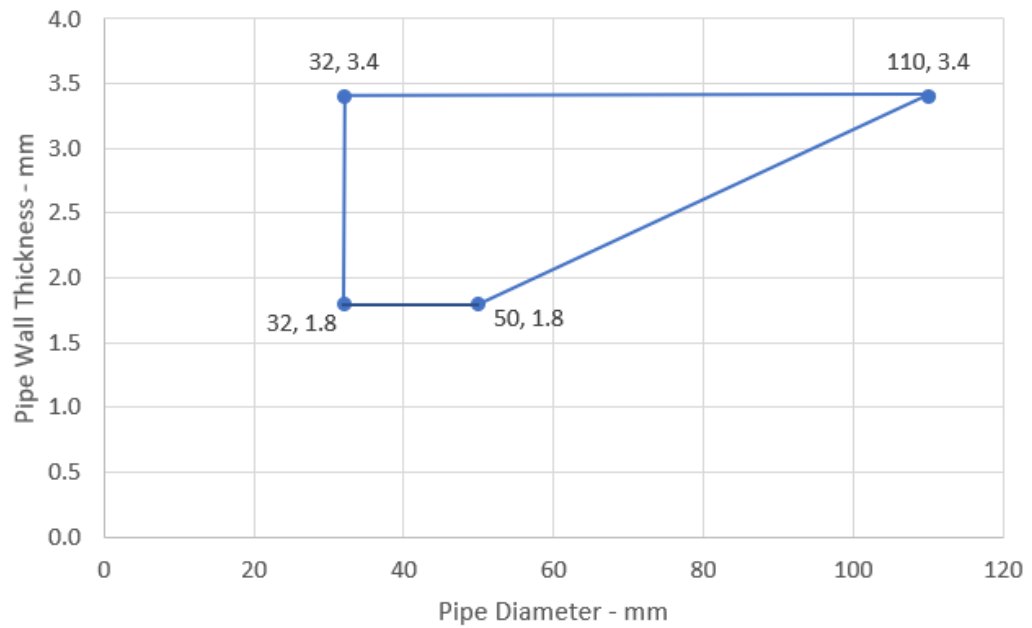

Wavin AS+ Pipes 32-200 / 50 mm Wrap

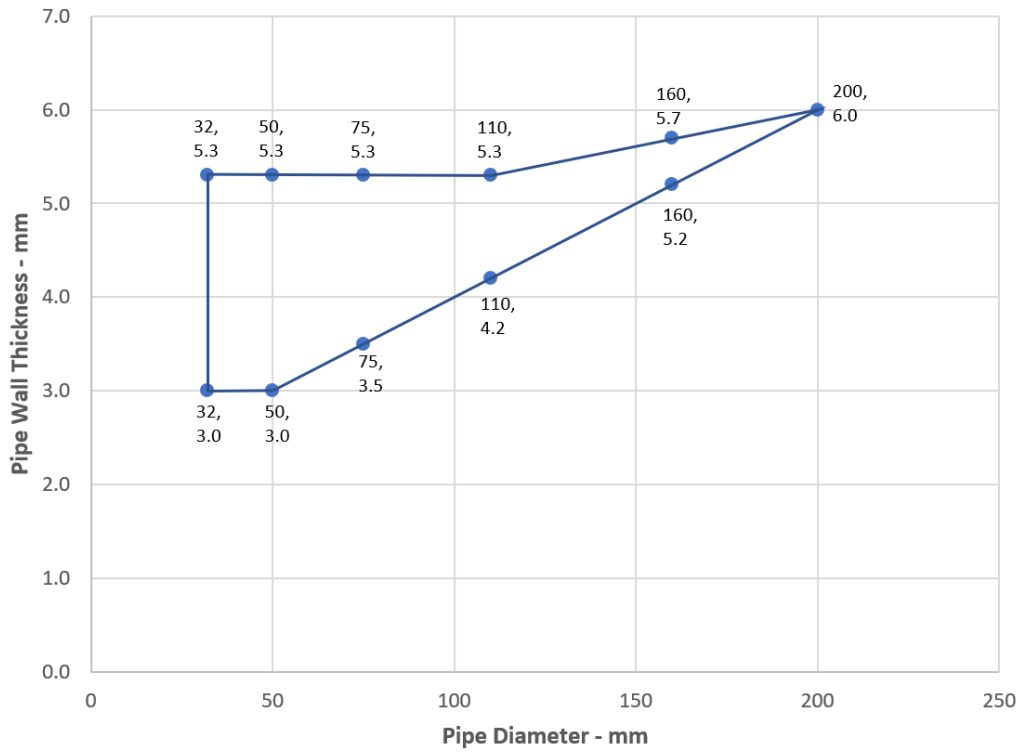

Gilbert Silent PP Pipes - U/C

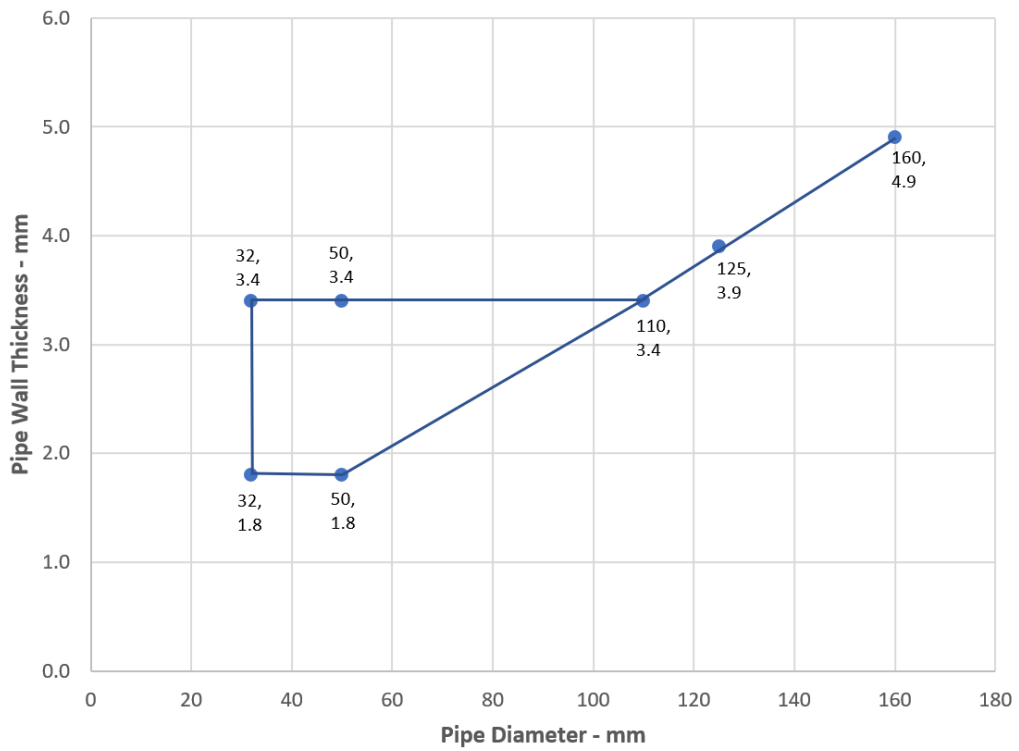

A.6.8 Protecta FR Service Coat FR1 penetration seal for steel pipes, in 2x Protecta FR Board 1-S, in flexible or rigid walls

Penetration Seal: Metallic pipes with Protecta FR Service Coat FR1 fitted at any position within the aperture, with 50 mm Protecta FR Board 1-S to both sides of the wall. Minimum separation between penetration seals and seal edges of 30 mm. (Configuration 1 & 2).

Construction details:

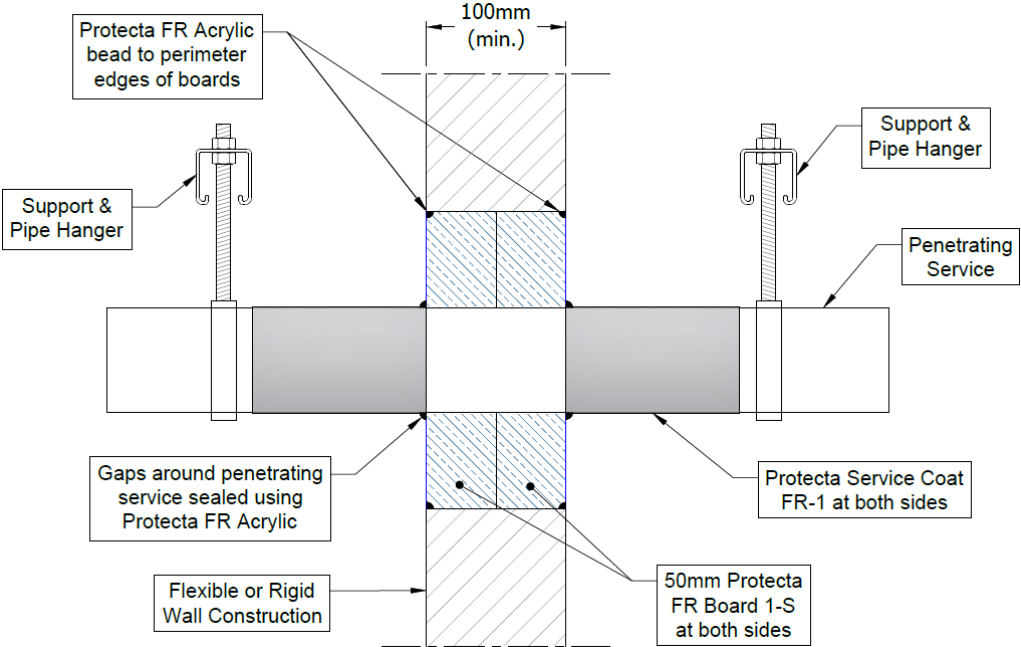

Configuration 1:

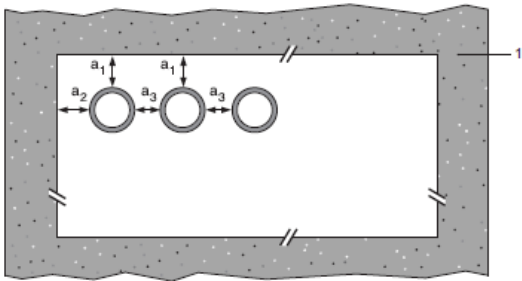

Configuration 2:

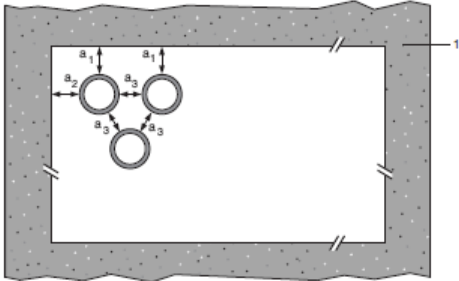

Key

- 1 Supporting construction
- a1 Pipe / top edge of seal separation
- a2 Pipe / side edge of seal separation
- a3 Pipe / pipe separation

A.6.8.1

Services	Insulation, minimum	Classification
Mild or stainless steel pipe		
Maximum 63 mm diameter*	Protecta FR Service Coat FR-1, 750-micron DFT extending 200 mm from both faces of the Protecta FR Board fire seal	EI 120 C/C
	Protecta FR Service Coat FR-1, 1500-micron DFT extending 200 mm from both faces of the Protecta FR Board fire seal	E 90 C/U, EI 60 C/U
Maximum 114 mm diameter	Protecta FR Service Coat FR-1, 1000-micron DFT extending 200 mm from both faces of the Protecta FR Board fire seal	E 120 C/U, EI 45 C/U

* Typical pipe diameters shown, see below graph for intermediate sizes

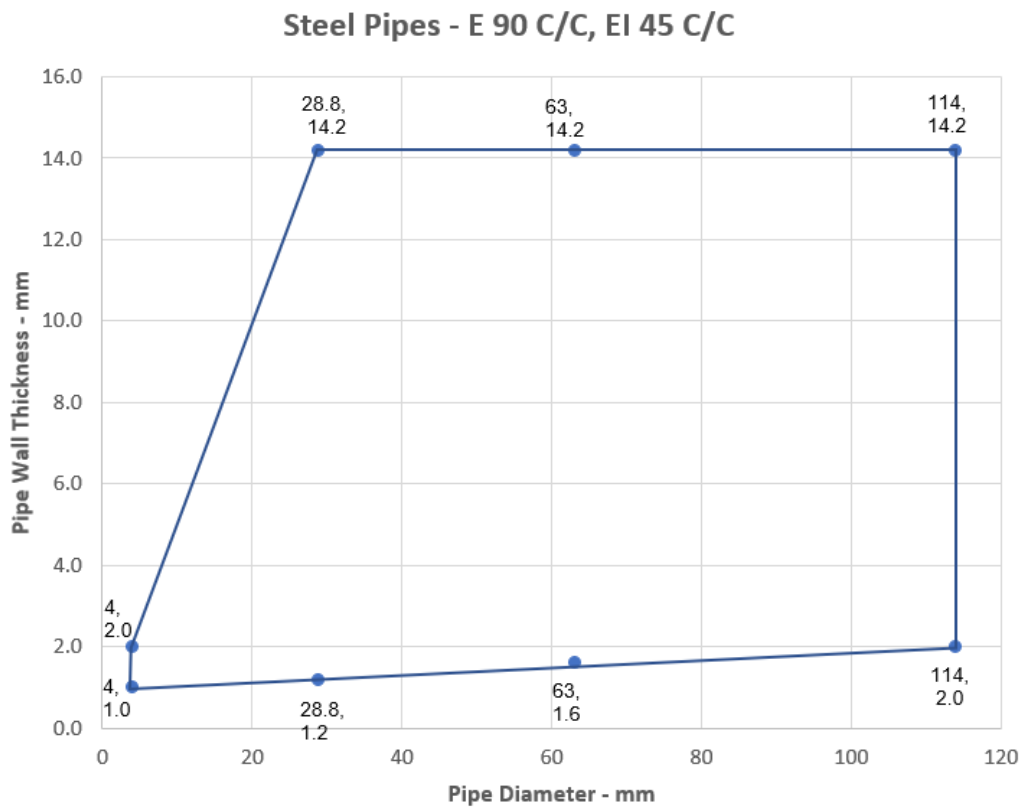

A.6.9 Protecta FR Graphite penetration seal for pipes, in 2x Protecta FR Board 1-S, in flexible or rigid walls

Penetration Seal: Metallic pipes with 5-10 mm annulus by 25 mm deep Protecta FR Graphite to both sides of the seal, backed with 25 mm deep minimum 33 kg/m³ stone wool insulation fitted around services, within 50 mm Protecta FR Board 1-S to both sides of the wall within the aperture. Minimum separation between penetration seals and seal edges of 30 mm (a1 and a2). Min. separation between services of 0 mm (a3) (Configuration 1 & 2).

Construction details:

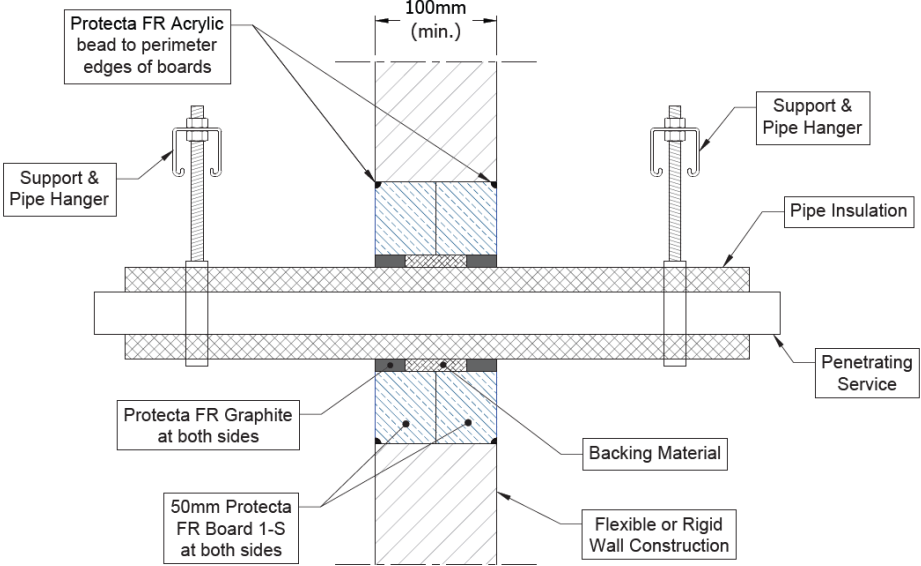

Configuration 1:

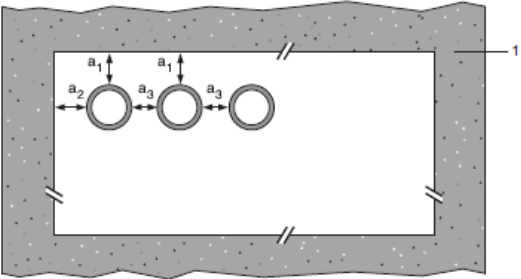

Configuration 2:

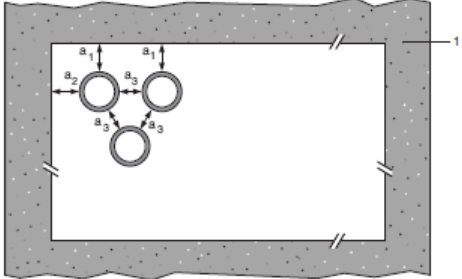

Key

- 1 Supporting construction
- a1 Pipe / top edge of seal separation
- a2 Pipe / side edge of seal separation
- a3 Pipe / pipe separation

A.6.9.1

Services	Insulation	Classification
Copper or steel pipe		
6 mm diameter*	9 mm elastomeric insulation minimum class B-s3, d0 (CS)	EI 120 C/C
Maximum 18 mm diameter*	9 mm elastomeric insulation minimum class B-s3, d0 (CS)	E 120 C/C, EI 90 C/C
Maximum 54 mm diameter*	19 mm elastomeric insulation minimum class B-s3, d0 (CS)	E 120 C/C, EI 90 C/C
Maximum 54 mm diameter*	25 mm phenolic insulation (CS)	E 120 C/C, EI 60 C/C
Alupex pipe		
14 mm diameter/2 mm wall	6 mm PE foam insulation minimum class E (CS)	E 90 C/C, EI 60 C/C

* Typical pipe diameters shown, see below graph for intermediate sizes

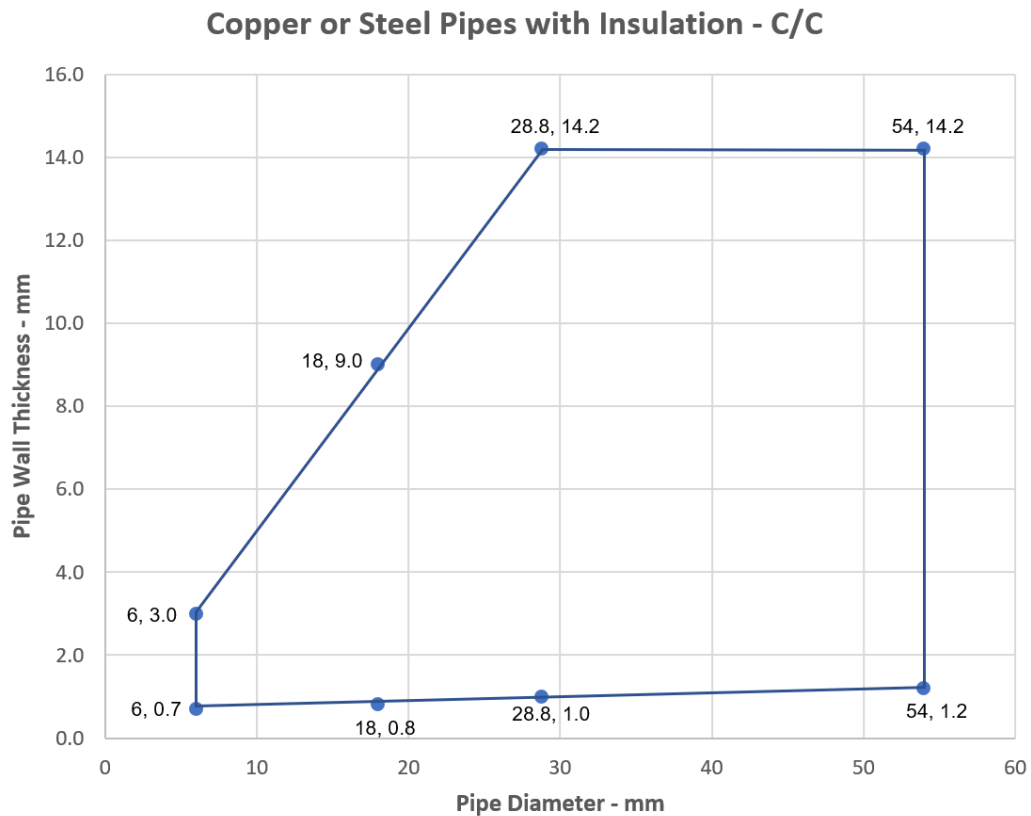

A.6.10 Penetration seal with 1x Protecta FR Board 50 2-S in framed aperture

Penetration Seal: Services fitted at any position within the aperture, with 50 mm Protecta FR Board 2-S positioned to either face of the wall (or anywhere in between). Minimum 30 mm separation between pipes. Protecta FR Collars fixed with 50mm pigtail screws. Cables and cable trays coated 150mm each side of FR Board with nominally 300µm WFT Protecta Service Coat FR-1. In rigid wall constructions the wall thickness can be minimum 75 mm.

Construction details:

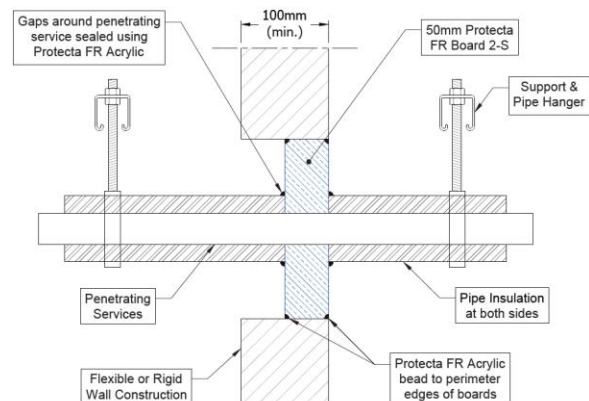
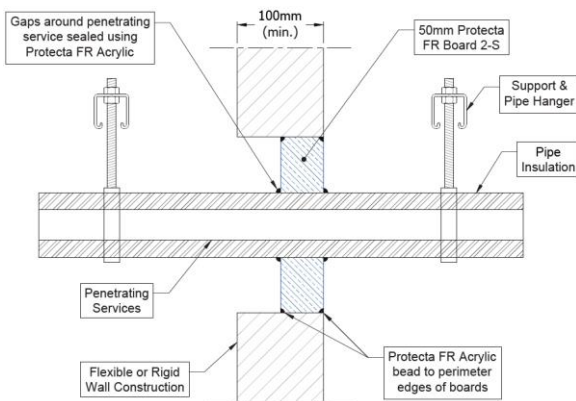
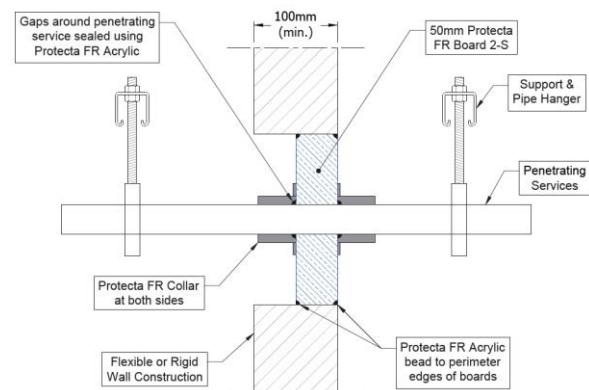
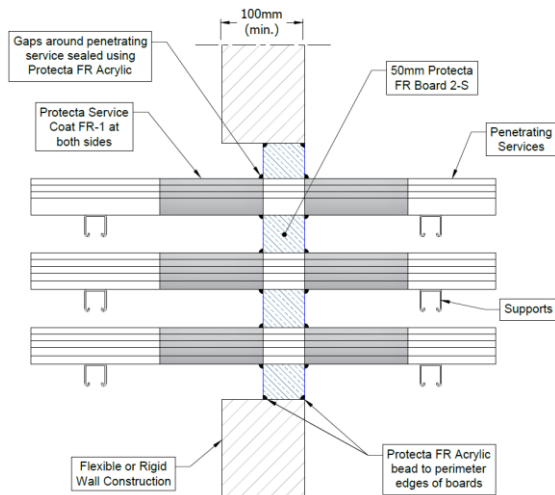

A.6.10.1 Single side penetration seal with cables

Services	Maximum aperture	Classification
Electrical cables up to 80 mm Ø (single, bundled and on trays)	1200 mm wide x 600 mm high	EI 60
Cables up to 21mm Ø in tied bundles up to 100mm Ø		
Perforated Steel cable trays & ladders		EI 60
Unperforated steel cable trays		E 60, EI 45
Unsheathed wires up to 24 mm Ø		E 60, EI 45

A.6.10.2 Single side penetration seal with metallic pipes

Services	Maximum Aperture	Insulation CS	Classification
Mild or stainless steel pipe	1200 mm wide x 600 mm high	20 mm Stone wool insulation min. 80 kg/m ³	E 90 C/U, EI 60 C/U
40 mm diameter/1.0-14.2 mm wall*		30 mm Stone wool insulation min. 80 kg/m ³	
40 mm diameter/1.0-14.2 mm wall*			
50 mm diameter/1.7-14.2 mm wall*			
60 mm diameter/1.8-14.2 mm wall*			
75 mm diameter/2.1-14.2 mm wall*			
90 mm diameter/2.3-14.2 mm wall*			
100 mm diameter/2.5-14.2 mm wall*			
115 mm diameter/2.8-14.2 mm wall*			
140 mm diameter/3.2-14.2 mm wall*			
165 mm diameter/ 3.6-14.2 mm wall*			
180 mm diameter/ 3.9-14.2 mm wall*			
200 mm diameter/ 4.2-14.2 mm wall*			
219 mm diameter/ 4.5-14.2 mm wall*			
250 mm diameter/ 5.0-14.2 mm wall*			
300 mm diameter/ 5.9-14.2 mm wall*			
324 mm diameter/ 6.35-14.2 mm wall*			

* Typical pipe diameters shown, see below graph for intermediate sizes

CS – Continuous Sustained

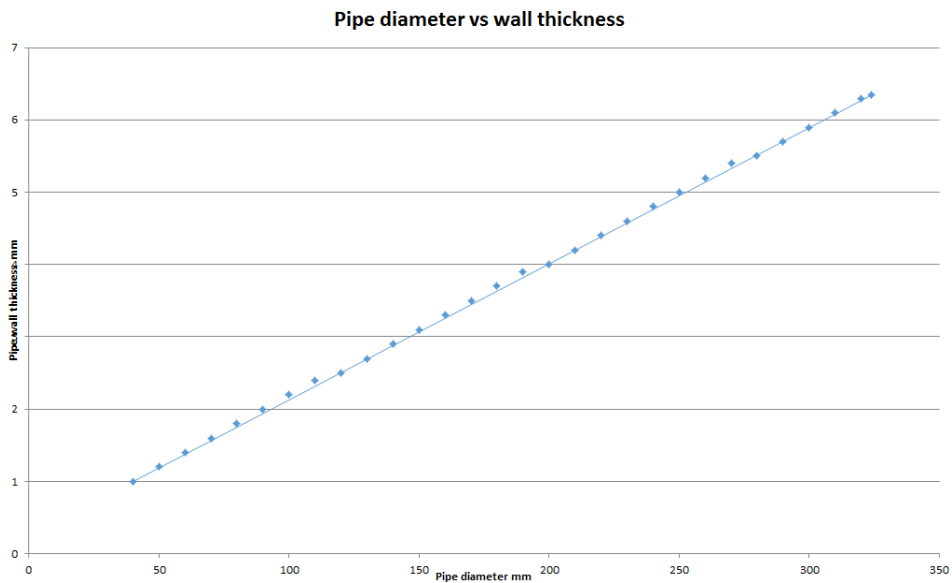

Services	Maximum Aperture	Insulation CS	Classification
Copper or steel pipe maximum 54 mm diameter*	1200 mm wide x 600 mm high	20-50 mm stone wool insulation min. 80 kg/m ³	E 90 C/C, EI 60 C/C
Copper or steel pipe maximum 54 mm diameter*		20-40 mm glass or stone wool insulation min. 75 kg/m ³	E 60 C/C, EI 30 C/C
Alupex pipe maximum 75 mm diameter/2.25-4.7 mm wall*		20-50 mm stone wool insulation min. 80 kg/m ³	EI 60 C/C
Alupex pipe maximum 16 mm diameter/2.25 mm wall		20 mm glass or stone wool insulation min. 75 kg/m ³	E60 C/C, EI 45 C/C
Alupex pipe maximum 75 mm diameter/4.6 mm wall		25 mm glass or stone wool insulation min. 75 kg/m ³	EI 60 C/C

*See below graph for interpolation pipe sizes

Copper Pipes with Insulation - C/C

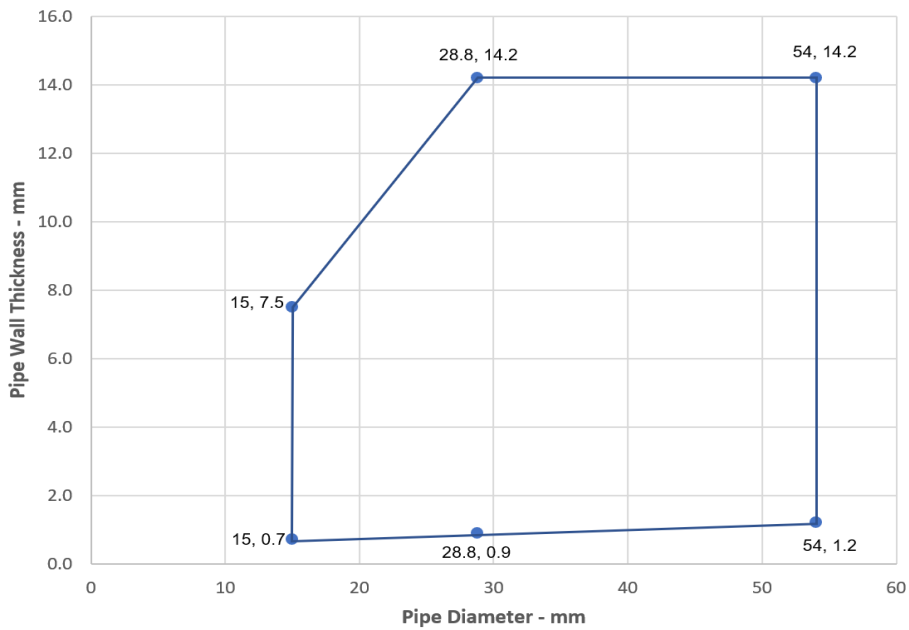

Alupex Pipes with Insulation - C/C

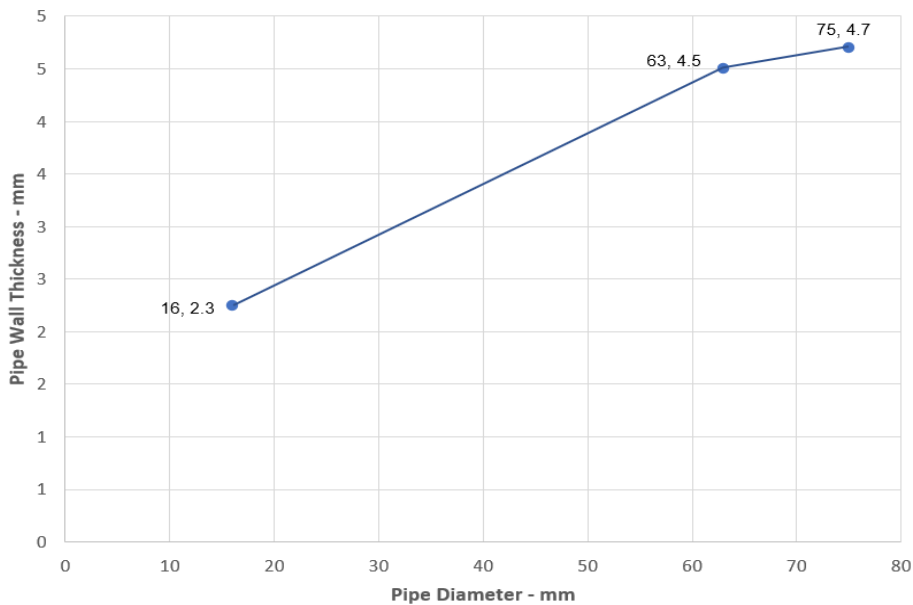

Services	Maximum Aperture	Insulation LI or CI	Classification
Copper or steel pipe maximum 54 mm diameter*	1200 mm wide x 600 mm high	Min. 500 mm length, min. 20 mm thick glass or stone wool insulation 75 kg/m ³	E 60 C/C, EI 45 C/C
Copper or steel pipe maximum 54 mm diameter*	1200 mm wide x 600 mm high	Min. 500 mm length, min. 20 mm thick stone wool insulation min. 80 kg/m ³	E 90 C/C, EI 60 C/C

*See below graph for interpolation pipe sizes

Copper Pipes with Insulation - C/C

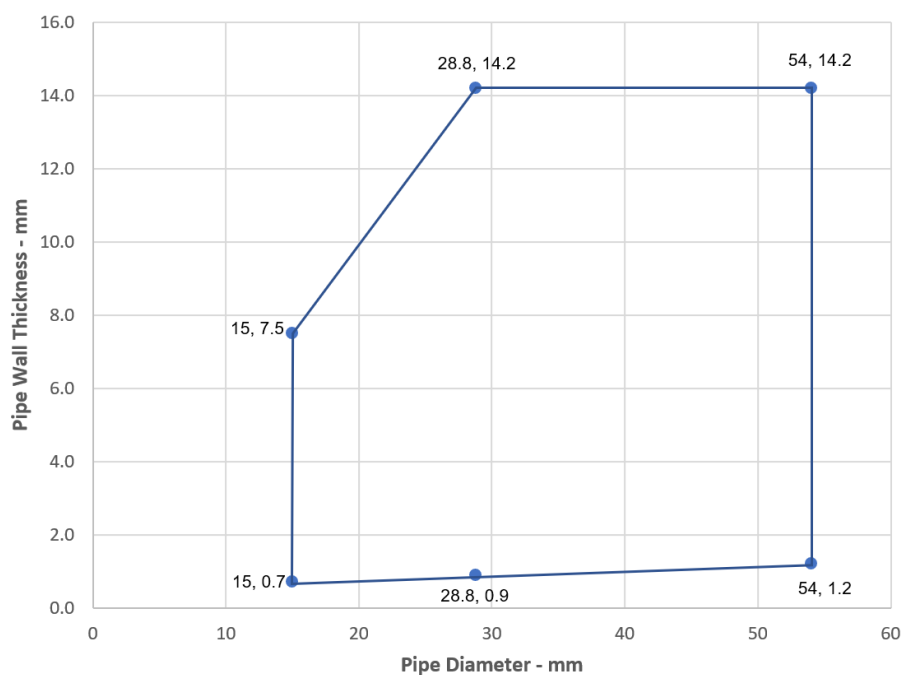

Services	Collar	Insulation CS	Classification
Copper pipe			
Maximum 54 mm diameter*	Maximum 110 mm diameter/50 mm high	9-25 mm elastomeric insulation min. class B-s3, d0 or PE Foam insulation	E 60 C/C, EI 30 C/C
Alupex pipe			
Maximum 16 mm diameter, wall thickness 2.25 mm	Maximum 40 mm diameter/50 mm high	9 mm elastomeric insulation min. class B-s3, d0 or PE Foam insulation	EI 60 C/C
Maximum 75 mm diameter, wall thickness 2.25-4.6 mm	Maximum 110 mm diameter/50 mm high		E 60 C/C, EI 45 C/C
Maximum 75 mm diameter, wall thickness 2.25-4.6 mm	Maximum 125 mm diameter/50-60mm high	13-25 mm elastomeric insulation min. class B-s3, d0 or PE Foam insulation	EI 60 C/C

*See below graph for interpolation pipe sizes

Copper Pipes - E 60 C/C, EI 30 C/C

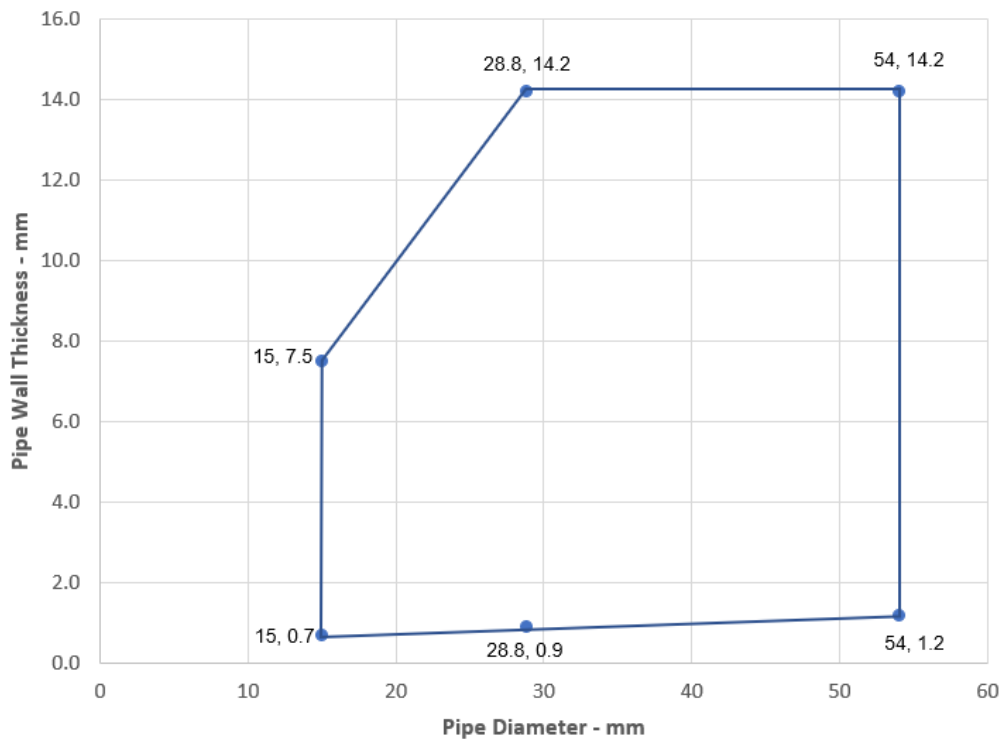

A.6.10.3 Single side penetration seal with plastic pipes

Services	Collar Inlay	Classification
PVC-U pipe according to EN 1329-1, EN 1452-1 and EN 1453-1 and PVC-C according to EN 1566-1		
Diameter 32 mm, wall thickness 1.9 mm	30 x 3.0 mm	E 90 U/C, EI 45 U/C
Diameter 40 mm, wall thickness 1.9 mm	30 x 3.0 mm	
Diameter 50 mm, wall thickness 3.7-6.6 mm	30 x 3.0 mm	
Diameter 55 mm, wall thickness 3.7-6.6 mm	30 x 3.2 mm	E 90 U/C, EI 30 U/C
Diameter 63 mm, wall thickness 3.7-6.6 mm	30 x 3.6 mm	
Diameter 75 mm, wall thickness 3.7-6.6 mm	30 x 4.2 mm	
Diameter 82 mm, wall thickness 3.7-6.6 mm	30 x 4.6 mm	
Diameter 90 mm, wall thickness 3.7-6.6 mm	30 x 5.0 mm	
Diameter 110 mm, wall thickness 2.7-6.6 mm	30 x 6.0 mm	
32 mm diameter*	50 x 3.0 mm	E 120 U/C, EI 60 U/C
40 mm diameter *	50 x 3.0 mm	
50 mm diameter *	50 x 3.0 mm	
55 mm diameter *	50 x 3.2 mm	E 90 U/C, EI 60 U/C
63 mm diameter *	50 x 3.6 mm	
75 mm diameter *	50 x 4.2 mm	
82 mm diameter *	50 x 4.6 mm	
90 mm diameter *	50 x 5.0 mm	
110 mm diameter *	50 x 6.0 mm	
125 mm diameter*	60 x 9.0 mm	EI 60 C/C
140 mm diameter*	60 x 11.5 mm	
160 mm diameter*	60 x 15.0 mm	

*See below graph for interpolation pipe sizes

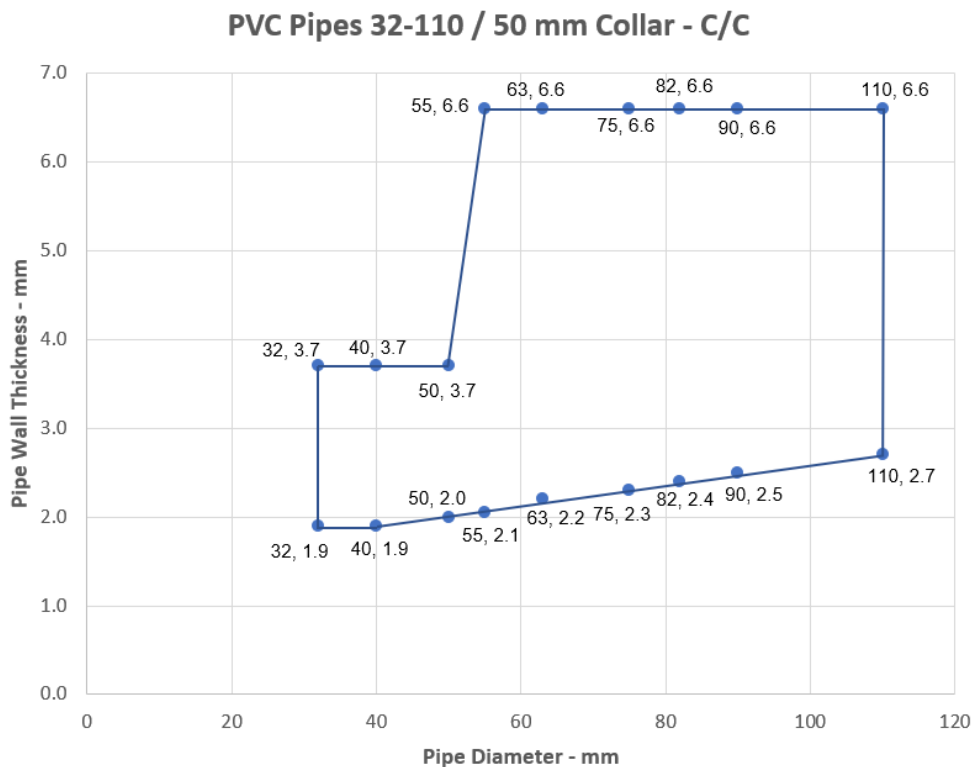

PVC Pipes 110-160 / 60 mm Collar - C/C

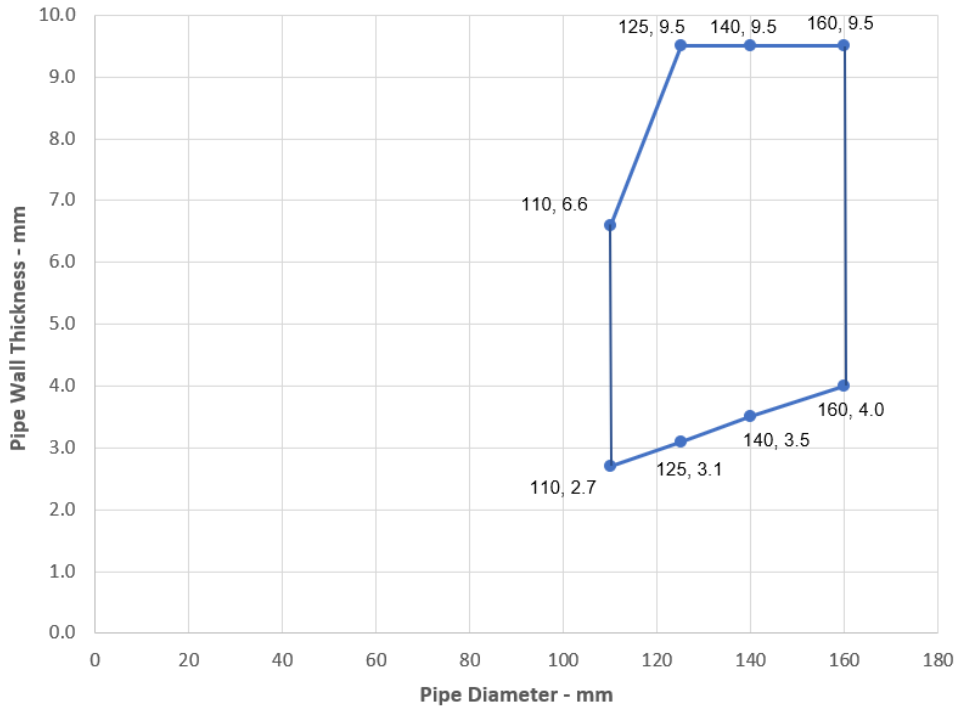

Services	Collar Inlay	Classification
PE pipe according to EN 1519-1, EN 12201-2 and EN 12666-1, ABS according to EN 1455-1 and pipes made from SAN+PVC according to EN 1565-1		
Diameter 32 mm, wall thickness 3.4-10.0 mm	30 x 3.0 mm	E 60 U/C, EI 45 U/C
Diameter 40 mm, wall thickness 3.4-10.0 mm	30 x 3.0 mm	
Diameter 50 mm, wall thickness 3.4-10.0 mm	30 x 3.0 mm	
Diameter 55 mm, wall thickness 3.4-10.0 mm	30 x 3.2 mm	
Diameter 63 mm, wall thickness 3.4-10.0 mm	30 x 3.6 mm	
Diameter 75 mm, wall thickness 3.4-10.0 mm	30 x 4.2 mm	
Diameter 82 mm, wall thickness 3.4-10.0 mm	30 x 4.6 mm	
Diameter 90 mm, wall thickness 3.4-10.0 mm	30 x 5.0 mm	
Diameter 110 mm, wall thickness 3.4-10.0 mm	30 x 6.0 mm	
32 mm diameter*	50 x 3.0 mm	E 120 U/C, 60 U/C
40 mm diameter*	50 x 3.0 mm	
50 mm diameter*	50 x 3.0 mm	
55 mm diameter*	50 x 3.2 mm	
63 mm diameter*	50 x 3.6 mm	E 90 C/C, EI 60 C/C
75 mm diameter*	50 x 4.2 mm	
82 mm diameter*	50 x 4.6 mm	
90 mm diameter*	50 x 5.0 mm	
110 mm diameter*	50 x 6.0 mm	
125 mm diameter*	60 x 9.0 mm	EI 60 C/C
140 mm diameter*	60 x 11.5 mm	
160 mm diameter*	60 x 15.0 mm	

*See below graph for interpolation pipe sizes

PE Pipes 32-110 / 50 mm Collar - U/C

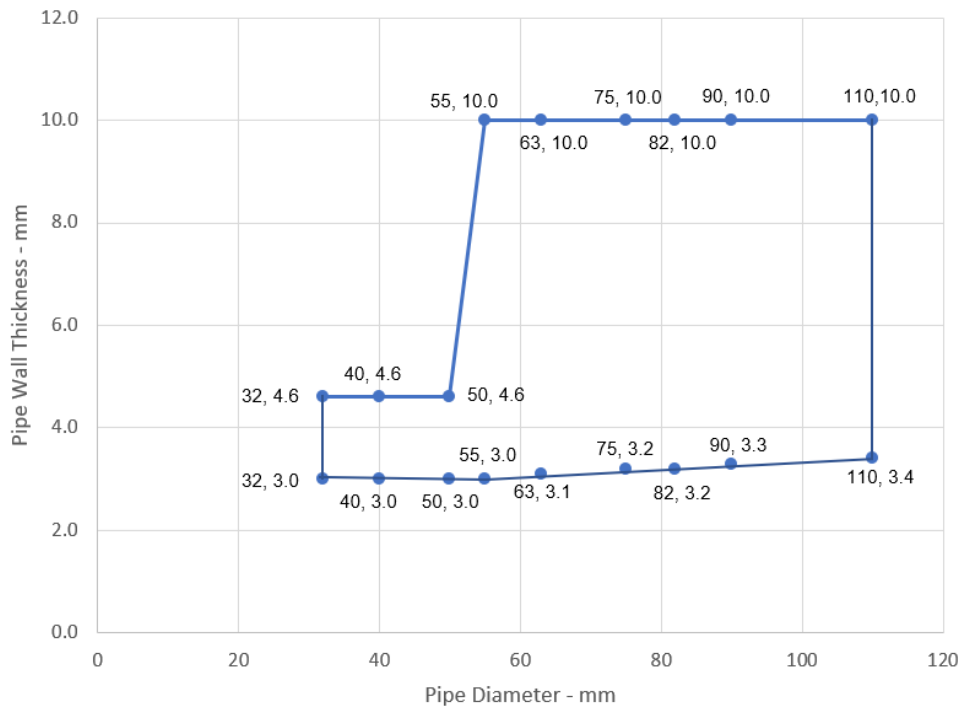

PE Pipes 110-160 / 60 mm Collar - C/C

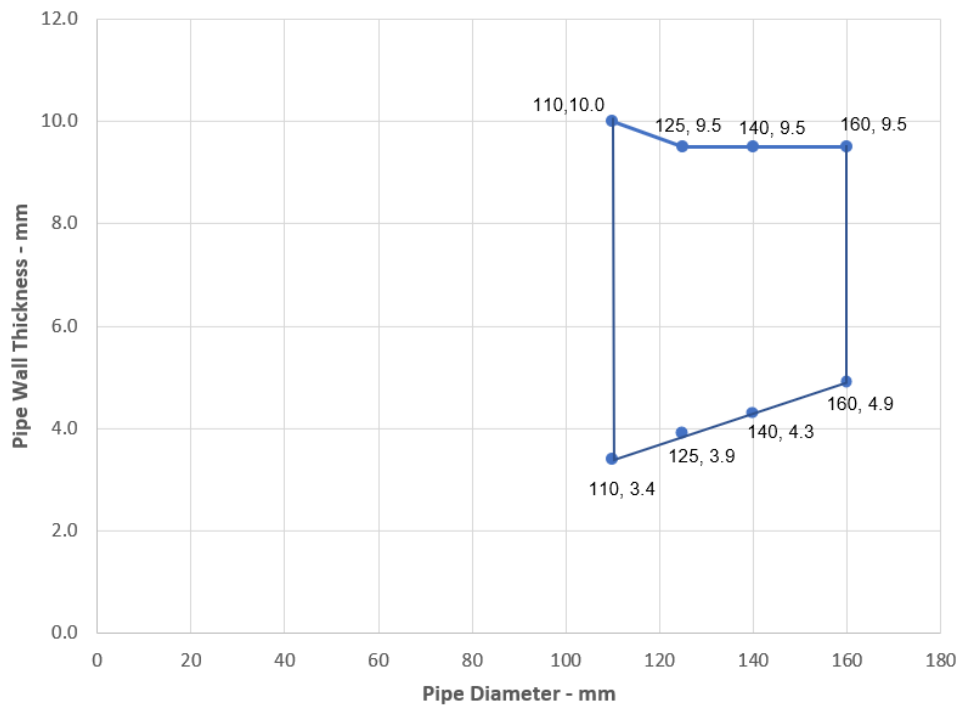

Services	Collar Inlay	Classification
PP pipe according to EN 1852-1: 2009		
32 mm diameter*	50 x 3.0 mm	EI 60 C/C
40 mm diameter*	50 x 3.0 mm	
50 mm diameter*	50 x 3.0 mm	
55 mm diameter*	50 x 3.2 mm	
63 mm diameter*	50 x 3.6 mm	
75 mm diameter*	50 x 4.2 mm	
82 mm diameter*	50 x 4.6 mm	
90 mm diameter*	50 x 5.0 mm	
110 mm diameter*	50 x 6.0 mm	
125 mm diameter*	60 x 9.0 mm	
140 mm diameter*	60 x 11.5 mm	
160 mm diameter*	60 x 15.0 mm	

*See below graph for interpolation pipe sizes

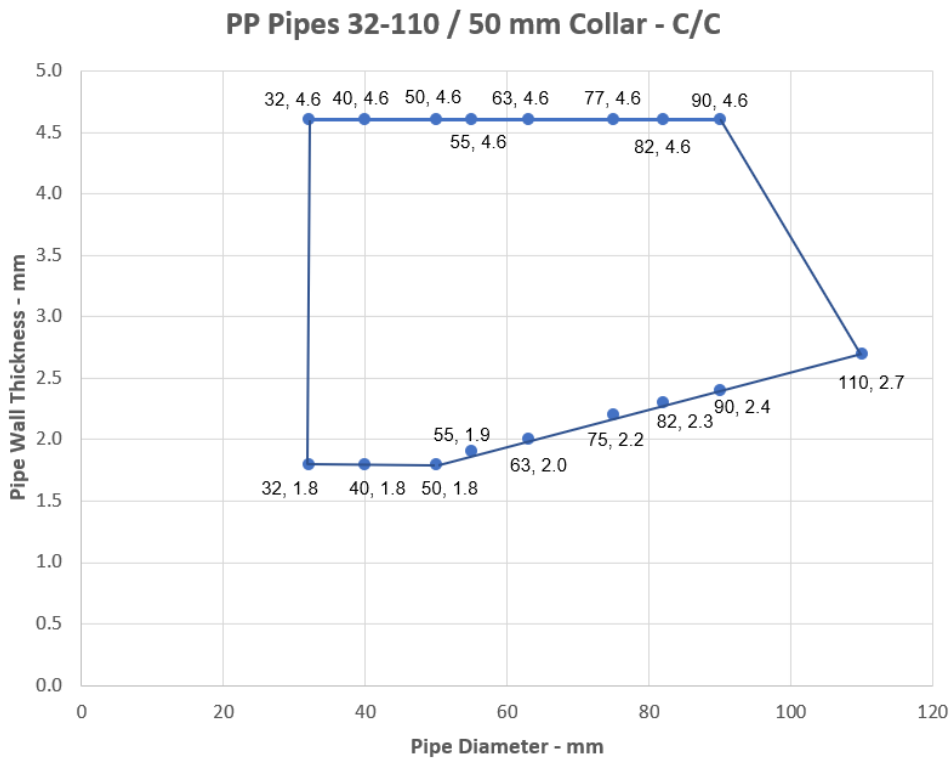

PP Pipes 110-160 / 60 mm Collar - C/C

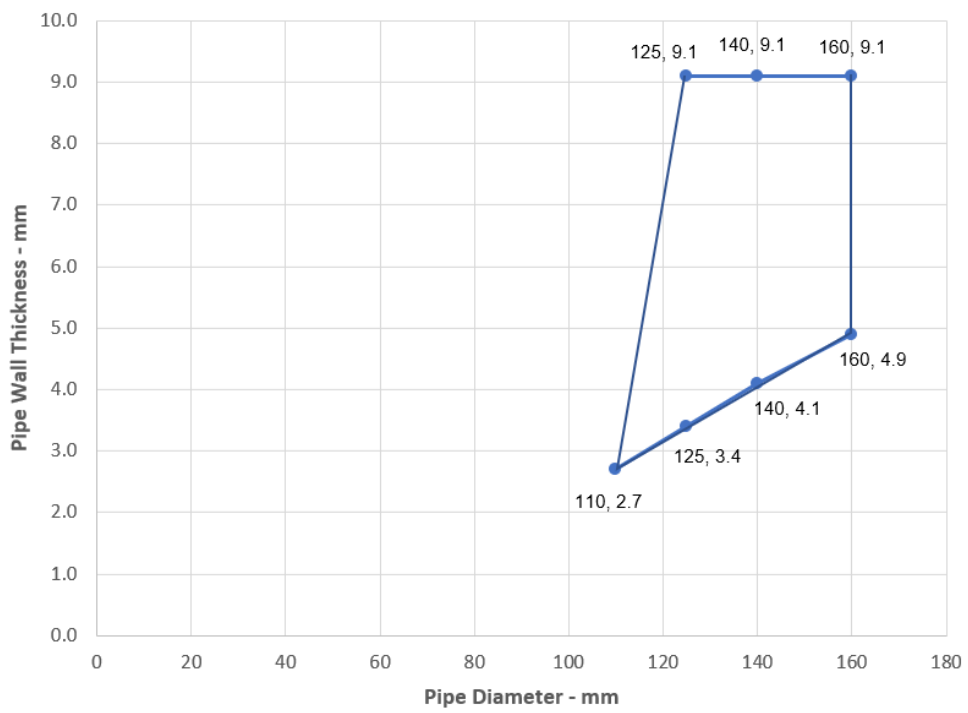

A.7 Flexible or rigid wall constructions according to 2. 2) with wall thickness of minimum 120 mm

A.7.1 Plastic pipe penetration seal with 2x Protecta FR Board 2-S

Penetration Seal: Pipes fitted at any position within the aperture, with 60 mm Protecta FR Board 2-S to both sides of the wall. Minimum 30 mm separation between pipes.

Construction details:

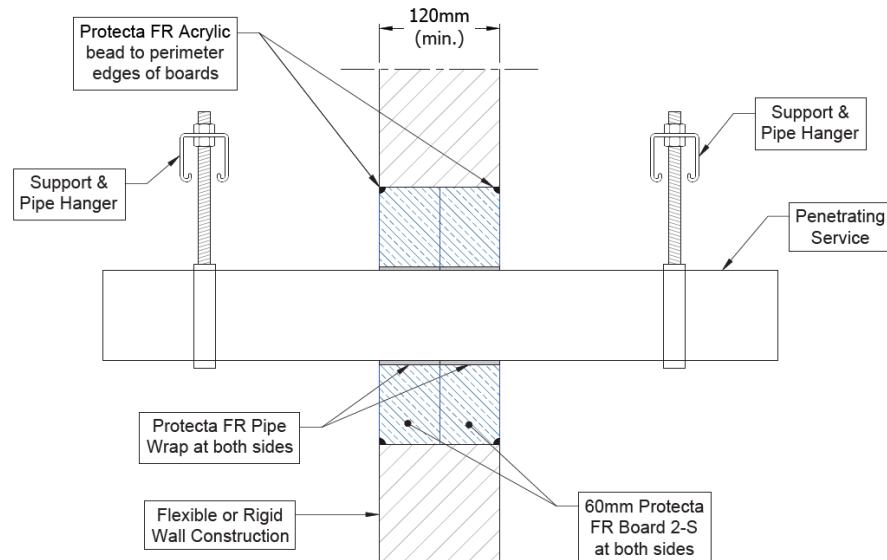

A.7.1.1 Double side penetration seal with plastic pipes

Services	Wraps (both sides)	Permitted configuration for seal separation	Classification
PVC-U pipe according to EN 1329-1, EN 1452-2 and EN 1453-1 and PVC-C according to EN 1566-1			
Diameter up to 40 mm, wall thickness 1.9-3.0 mm	50 x 3.6 mm (2 x 1.8 layer)	1 & 2	EI 120 C/C
Diameter up to 110 mm, wall thickness 2.7-6.6 mm	50 x 3.6 mm (2 x 1.8 layer)		
Diameter up to 160 mm, wall thickness 4.0-9.5 mm	50 x 10.8 mm (6 x 1.8 layer)		
PE pipe according to EN 1519-1, EN 12201-2 and EN 12006-1, ABS according to EN 1455-1 and pipes made from SAN+PVC according to EN 1565-1			
Diameter up to 40 mm, wall thickness 2.4-4.6 mm	50 x 1.8 mm (1 x 1.8 layer)	1 & 2	EI 120 C/C
Diameter up to 110 mm, wall thickness 3.4-10.0 mm	50 x 3.6 mm (2 x 1.8 layer)		
Diameter up to 160 mm, wall thickness 4.9-14.6 mm	50 x 10.8 mm (6 x 1.8 layer)		
PP pipe according to EN 1852-1: 2009			
Diameter up to 40 mm, wall thickness 1.8-5.5 mm	50 x 1.8 mm (1 x 1.8 layer)	1 & 2	EI 120 C/C
Diameter up to 110 mm, wall thickness 2.7-10.0 mm	50 x 3.6 mm (2 x 1.8 layer)		
Diameter up to 160 mm, wall thickness 4.9-14.6 mm	50 x 10.8 mm (6 x 1.8 layer)		

*See below graph for interpolation pipe sizes

PVC Pipes 40-160 - C/C

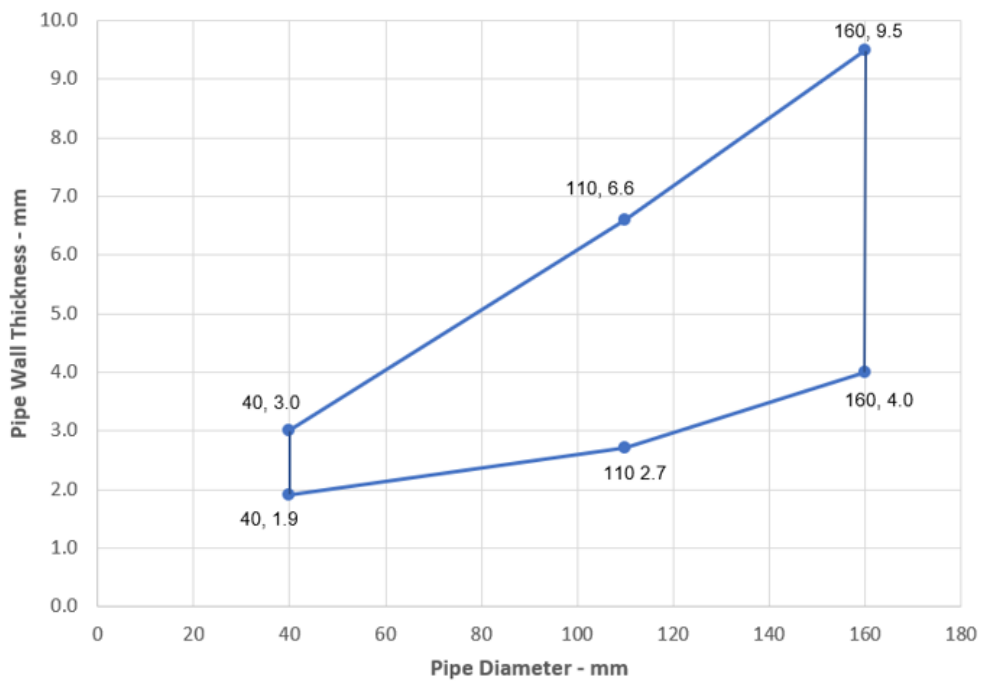

PE Pipes 40-160 - C/C

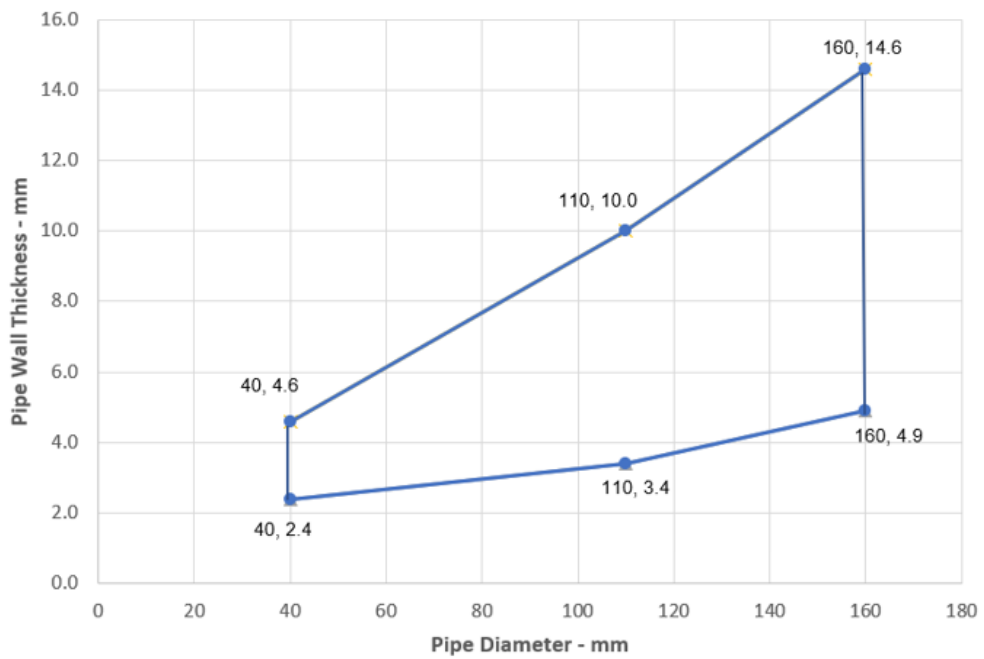

PP Pipes 40-160 - C/C

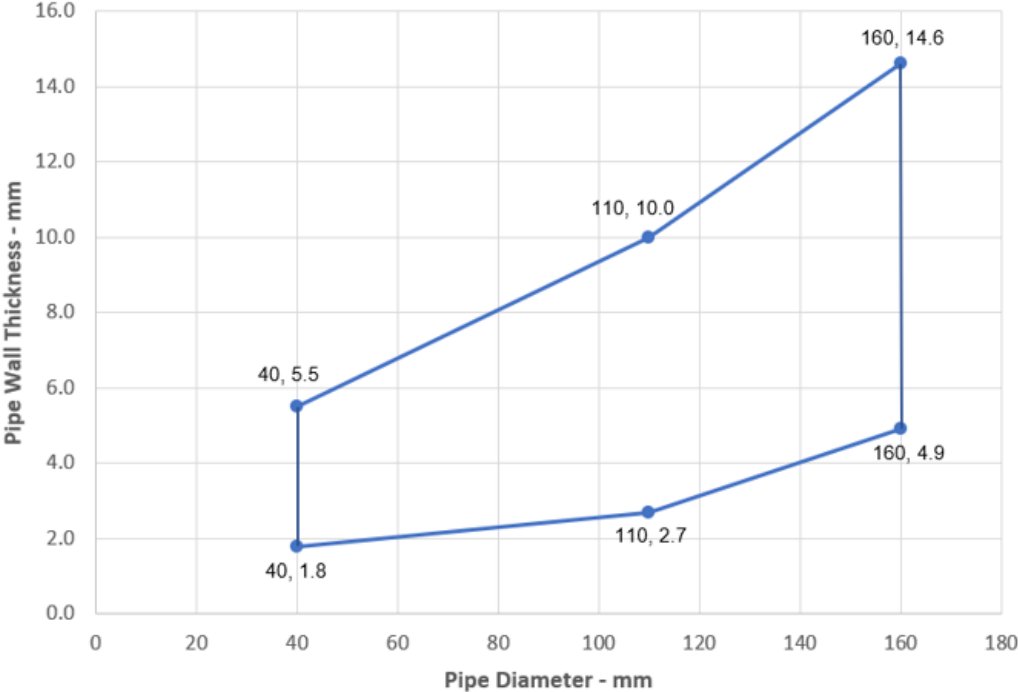

A.7.2 Metallic pipe penetration seal with 2x Protecta FR Board 1-S

Penetration Seal: Metallic pipes fitted at any position within the aperture, with 50 mm Protecta FR Board 1-S to both sides of the wall. Minimum separation between penetration seals and seal edges of 30 mm. (Configuration 1 & 2).

Construction details:

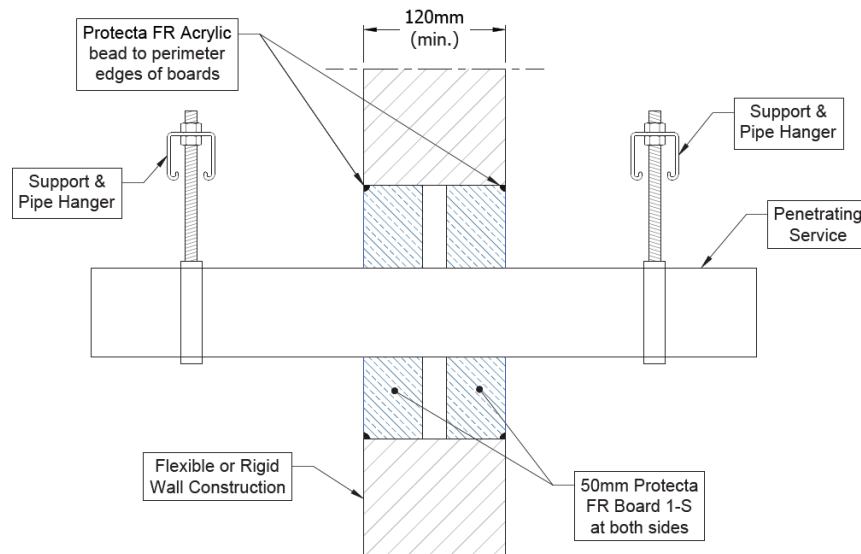

A.7.2.1 Double side penetration seal with metallic pipes

Services	Insulation	Permitted configuration for seal separation	Classification
Mild or stainless steel pipe	None	1 & 2	E 120 C/U, EI 30 C/U
Maximum 63 mm diameter *			E 120 C/U, EI 20 C/U
63-324 mm diameter*			
Copper, mild or stainless steel pipe			
12 mm diameter /0.7-6.0 mm wall thickness	None	1 & 2	E 120 C/C, EI 30 C/C
12-54 mm diameter *			E 120 C/C, EI 15 C/C
Alupex pipe			
Maximum 75 mm diameter*	None	1 & 2	E 120 C/C, EI 20 C/C

*See below graph for interpolation pipe sizes

Mild or Stainless Steel Pipes - E 120 C/U, EI 20 C/U

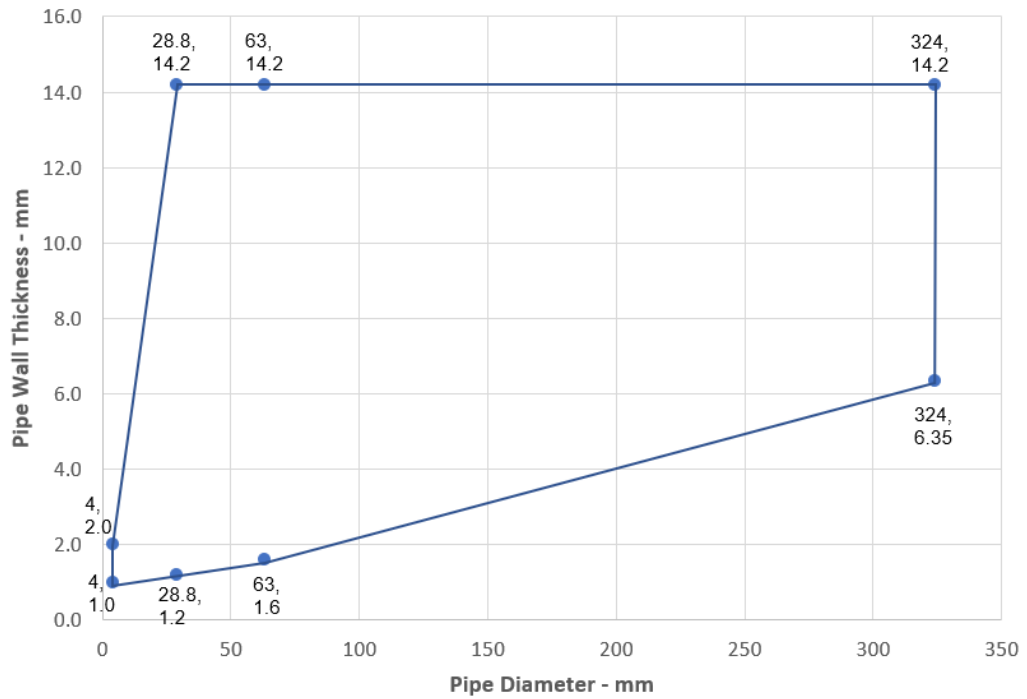

Copper, mild or Stainless Steel Pipes - E 120 C/C, EI 15 C/C

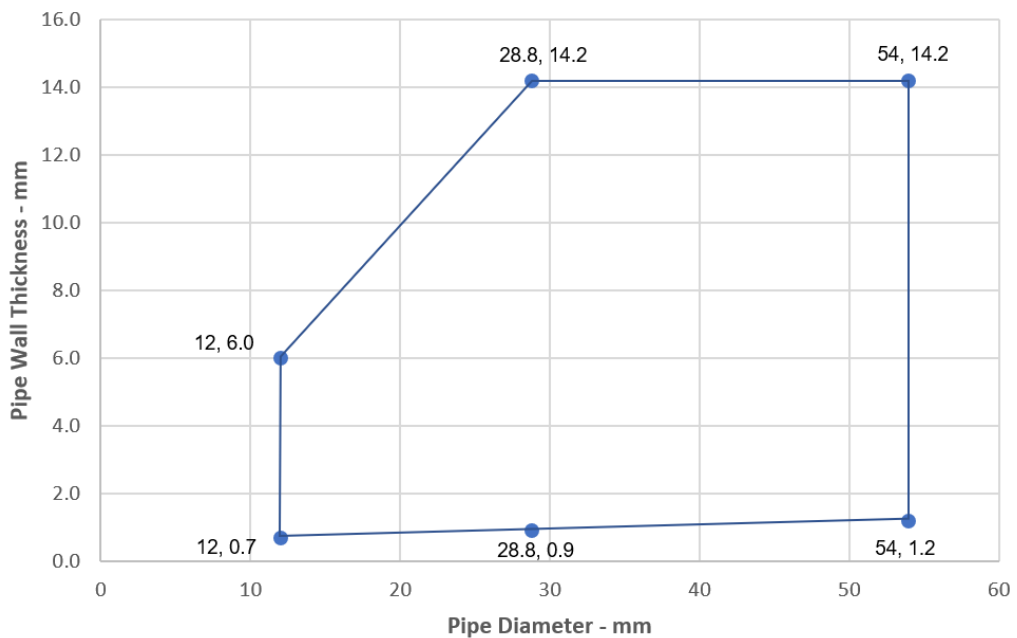

Alupex Pipes - E 120 C/C, EI 20 C/C

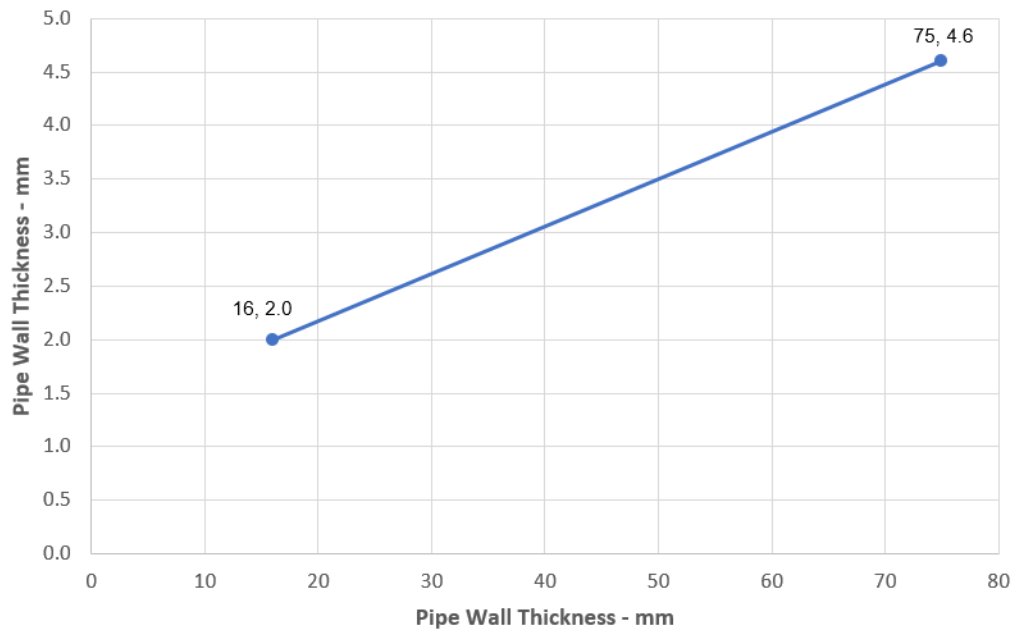

A.8 Timber wall constructions according to 2. 2) with wall thickness of minimum 100 mm

A.8.1 FR Board 50 mm 1-S penetration seal (pattress) with cables

Penetration Seal: Cables fitted at any position within the aperture, with 50 mm Protecta FR Board 1-S to both sides of the wall. Boards to be pattress fixed with 100 mm wood screws and penny washers at 300 mm centres and with a minimum 100 mm overlap around the opening.

Construction details:

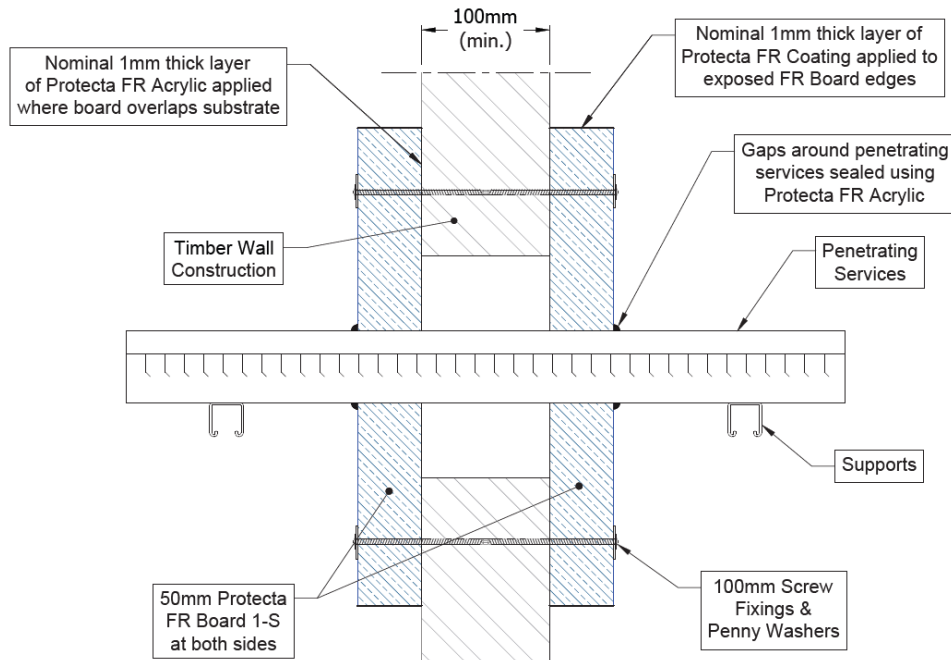

A.8.1.1 Two side penetration seal with cables

Services	Maximum aperture	Classification
Electrical cables up to 21 mm Ø (single, bundled and on trays)	1200 mm x 600 mm	E 120, EI 90
Electrical cables up to 50 mm Ø (single, bundled and on trays)		

ANNEX B – Air Permeability – Protecta FR Board

Product tested	1200mm high x 600mm wide Protecta FR Board 50mm 2-S		
Summary of testing procedure		Result	
	Pressure (Pa)	Leakage (m ³ /h)	Leakage (m ³ /m ² /h)
Results under negative chamber pressure	25	0.00	0.00
	50	0.01	0.01
	100	0.02	0.03
	200	0.04	0.06
	300	0.11	0.15
	450	0.49	0.68
	600	0.95	1.32
Results under positive chamber pressure	25	0.00	0.00
	50	0.01	0.01
	100	0.03	0.04
	200	0.08	0.11
	300	0.2	0.28
	450	0.63	0.88
	600	1.01	1.40

