



ETA-Danmark A/S  
Göteborg Plads 1  
DK-2150 Nordhavn  
Tel. +45 72 24 59 00  
Internet [www.etadanmark.dk](http://www.etadanmark.dk)

Authorised and notified  
according to Article 29 of the  
Regulation (EU)  
No 305/2011 of the European  
Parliament and of the Council  
of 9 March 2011



## European Technical Assessment ETA-21/0078 of 2022/03/04

### I General Part

**Technical Assessment Body issuing the ETA and designated according to Article 29 of the Regulation (EU) No 305/2011: ETA-Danmark A/S**

**Trade name of the construction product:**

FPMF Board

**Product family to which the above construction product belongs:**

Fire Stopping and Sealing Product:  
• Penetration Seals

**Manufacturer:**

Würth International AG  
Aspermontstrasse 1  
CH- 7000 Chur  
Switzerland

**Manufacturing plant:**

A/003

**This European Technical Assessment contains:**

92 pages including 2 annexes which form an integral part of the document

**This European Technical Assessment is issued in accordance with Regulation (EU) No**

EAD 350454-00-1104

**This version replaces:**

-

**Translations of this European Technical Assessment in other languages shall fully correspond to the original issued document and should be identified as such.**

**Communication of this European Technical Assessment, including transmission by electronic means, shall be in full. However, partial reproduction may be made, with the written consent of the issuing Technical Assessment Body. Any partial reproduction has to be identified as such.**

**Table of Contents**

<b>I.</b>	<b>SPECIFIC PARTS OF THE EUROPEAN TECHNICAL ASSESSMENT</b>	<b>4</b>
1	Technical description of the product	4
2	Specification of the intended uses of the product in accordance with the applicable European Assessment Document (Hereinafter EAD): EAD 350454-00-1104	5
3	Performance of the product and references to the methods used for its assessment	7
4	ASSESSMENT AND VERIFICATION OF CONSTANCY OF PERFORMANCE (HEREINAFTER AVCP) SYSTEM APPLIED, WITH REFERENCE TO ITS LEGAL BASE	8
5	Technical details necessary for the implementation of the AVCP system, as provided for in the applicable EAD	8
<b>ANNEX A</b>	<b>– Resistance to Fire Classification – FPMF Board</b>	<b>9</b>
A.1	Rigid wall constructions according to 2. 2)	9
A.1.1	Cable penetration seal with 2x 60 mm thick FPMF Board 2-S in minimum 150 mm thick walls	9
A.1.2	Cable penetration seal with 1x 60 mm thick FPMF Board 2-S	10
A.1.3	Pipe penetration seal with 2x 60 mm thick FPMF Board 2-S	11
A.1.4	Pipe penetration seal with 2x FPMF Board 2-S	13
A.1.5	Pipe penetration seal with 1x 60 mm thick FPMF Board 2-S	15
A.1.6	Pipe penetration seal with 1x FPMF Board 2-S	21
A.1.7	FPMF Board 60 mm 2-S penetration seal (protruding) blank and with cables, in rigid wall min. 150 mm thick	25
A.1.8	FPMF Board 60 mm 2-S penetration seal (pattress) blank and with cables, in rigid wall min. 150 mm thick	26
A.1.9	Penetration seal with 2x FPMF Board 2-S	27
A.2	Rigid floor constructions according to 2. 2) with floor thickness of minimum 150 mm	29
A.2.1	Cable penetration seal with 2x FPMF Board 2-S	29
A.2.2	Cable penetration seal with 1x FPMF Board 2-S	30
A.2.3	Pipe penetration seal with 2x FPMF Board 2-S	31
A.2.4	Pipe penetration seal with 1x FPMF Board 2-S	33
A.2.5	Pipe penetration seal with 1x FPMF Board 2-S	36
A.2.6	Pipe penetration seal with 1x FPMF Board 2-S	37
A.2.7	Pipe penetration seal with 2x FPMF Board 2-S	38
A.2.8	Pipe penetration seal with 2x FPMF Board 2-S (back to back)	39
A.3	Timber floor constructions according to 2. 2) with floor thickness of minimum 150 mm	41
A.3.1	Cable penetration seal with 2x FPMF Board 1-S	41
A.3.2	Pipe penetration seal with 2x FPMF Board 1-S	42
A.4	Flexible or rigid wall constructions according to 2. 2) with wall thickness of minimum 75 mm	45
A.4.1	Cable penetration seal with 2x FPMF Board 30 1-S	45
A.4.2	Cable penetration seal with 2x FPMF Board 1-S	47
A.5	Flexible or rigid wall constructions according to 2. 2) with wall thickness of minimum 100 mm	48
A.5.1	Cable penetration seal with 2x FPMF Board 1-S	48
A.5.2	Pipe penetration seal with 2x FPMF Board 1-S	49
A.5.3	Pipe penetration seal with 2x FPMF Board 1-S	54
A.5.4	Pipe penetration seal with 2x FPMF Board 1-S	56
A.5.5	Pipe penetration seal with 2x FPMF Board 1-S	58
A.5.6	Pipe penetration seal with 2x FPMF Board 1-S	61
A.5.7	FP Pipe Wrap penetration seal for plastic pipes, in 2x FPMF Board 1-S, in flexible or rigid walls	64
A.5.8	FPMF Service Coating penetration seal for steel pipes, in 2x FPMF Board 1-S, in flexible or rigid walls	73
A.5.9	Penetration seal with 1x FPMF Board 50 2-S in framed aperture	75
A.6	Flexible or rigid wall constructions according to 2. 2) with wall thickness of minimum 120 mm	85
A.6.1	Plastic pipe penetration seal with 2x FPMF Board 2-S	85
A.6.2	Metallic pipe penetration seal with 2x FPMF Board 1-S	88
A.7	Timber wall constructions according to 2. 2) with wall thickness of minimum 100 mm	91
A.7.1	FPMF Board 50 mm 1-S penetration seal (pattress) with cables	91
<b>ANNEX B</b>	<b>– Air Permeability – FPMF Board</b>	<b>92</b>

**I. SPECIFIC PARTS OF THE EUROPEAN TECHNICAL ASSESSMENT**

**1 Technical description of the product**

- 1) FPMF Board is a coated mineral wool board used to reinstate the fire resistance performance of wall and floor constructions where they have been provided with apertures for the penetration of single or multiple services.
- 2) The FPMF Board is supplied coated on one face, referenced 1-S, or on both faces, referenced 2-S. The board or boards are then cut to allow the penetration of the required services, before being inserted into the aperture in the wall.
- 3) FP Pipe Wraps are required to be used in conjunction with FPMF Board depending upon the required application and classification (see Annex A). FP Pipe Wraps are the subject of a separate ETA which is not declared in the document for confidentiality reasons.
- 4) The applicant has submitted a written declaration that FPMF Board does not contain substances which have to be classified as dangerous according to Directive 67/548/EEC and Regulation (EC) No 1272/2008 and listed in the "Indicative list on dangerous substances" of the EGDS - taking into account the installation conditions of the construction product and the release scenarios resulting from there.

In addition to the specific clauses relating to dangerous substances contained in this European technical Assessment, there may be other requirements applicable to the products falling within its scope (e.g. transposed European legislation and national laws, regulations and administrative provisions). In order to meet the provisions of the Construction Products Regulation, these requirements need also to be complied with, when and where they apply.

**2 Specification of the intended uses of the product in accordance with the applicable European Assessment Document (Hereinafter EAD): EAD 350454-00-1104**

Detailed information and data is given in Annex A.

- 1) The intended use of FPMF Board is to reinstate the fire resistance performance of flexible wall, rigid wall and floor constructions, and timber wall and floor constructions where they are penetrated by various cables, metallic pipes, composite pipes and plastic pipes.
- 2) The specific elements of construction that the system FPMF Board may be used to provide a penetration seal in, are as follows:
  - a. Flexible walls: The wall must have a minimum thickness of 75 mm and comprise steel or timber studs\* lined on both faces with minimum 1 layer of 12.5 mm thick boards. Apertures are not required to be lined.
  - b. Timber walls: The wall must have a minimum thickness of 100 mm and comprise solid wood or cross-laminated timber.
  - c. Rigid walls: The wall must have a minimum thickness of 75 mm and comprise concrete, aerated concrete or masonry, with a minimum density of 650 kg/m<sup>3</sup>.
  - d. Rigid floors: The floor must have a minimum thickness of 150 mm and comprise aerated concrete or concrete with a minimum density of 650 kg/m<sup>3</sup>.
  - e. Timber floors: The floor must have a minimum thickness of 150 mm and comprise solid wood or cross-laminated timber.

\* no part of the penetration seal may be closer than 100 mm to a stud, the cavity must be closed between the penetration seal and the stud, and minimum 100 mm of insulation of class A1 or A2 according to EN 13501-1 must be provided within the cavity between the penetration seal and the stud.

The supporting construction must be classified in accordance with EN 13501-2 for the required fire resistance period.

Würth Fire Protection Systems which involve services penetrating both sides of a flexible wall may also be used in the situation where the services penetrates one side of the wall only and the remaining side of the wall is not penetrated at the same point (i.e. the services continues on the inside of the wall). All fire integrity and thermal insulation ratings for such single-sided penetrations remain the same as for the equivalent double-sided penetration.

- 3) The System FPMF Board may be used to provide a penetration seal with cables, cable trays, metallic pipes, composite pipes and plastic pipes, with and without insulation, with mixed services within the same seal/aperture (for details see Annex A).
- 4) The total amount of cross sections of services (including insulation) should not exceed 60% of the penetration area.
- 5) The system FPMF Board may be used to seal apertures in the separating element of unlimited width by 1200mm high in a wall (uninterrupted separating studs will be required at 2400 mm centres or less in flexible walls), and 2400mm by 1200 mm in a floor. The additional sizes that are permitted in floors are:

Where 2400 x 1200 mm is specified in Annex A

Width (mm)	Length (mm)
1100	2900
1000	4000
900	7000
≤ 800	∞ (infinite)

Where 1200 x 600 mm is specified in Annex A

Width (mm)	Length (mm)
500	2000
≤ 400	∞ (infinite)

The minimum permitted separation between adjacent seals/apertures is 200mm. Services should be a minimum of 25mm from seal edges. Services within the system FPMF Board seal do not require a minimum separation, except pipes where combustible pipe insulation penetrates the seal and plastic pipe penetrations which should be a minimum of 30 mm from other services in the aperture.

- 6) Services in floors shall be supported at maximum 250mm from the top face. Services in walls shall be supported at maximum 270mm from both faces of the wall.
- 7) Where PP pipes are mentioned in Annex A, this includes PP-MV, PP-H, PP-R and similar if the pipe is according to EN 1451-1 or DIN 8077/8078. Where PE pipes are mentioned, this includes PE-LD, PE-MD, PE-HD, PE-X and similar according to EN 1519-1, EN 12201-2 or EN 12666-1.
- 8) A patrix system is boards installed on the surface of a wall instead of inside the aperture which can be used in Annex A as an alternative installation method, limited to EI 120. The aperture can be located within the wall with maximum size 1100 x 1100 mm or towards the soffit with maximum size 550 mm high x 1100 mm wide. The boards must be oversailing the aperture by 50 mm on both sides of the wall, bonded to the wall with FPMF Coating and fixed with ≥ 5x100 mm single thread wood, masonry or concrete screws and penny washers of steel at 300 mm centres. Exposed board edges must be coated with FPMF Coating. Soffit applications can be fixed on three sides.
- 9) Solutions in Annex A for 100 mm thick flexible walls, can be used in timber walls (see 2.2) if installed as a patrix system on the surface of a wall instead of inside the aperture. The aperture can be maximum 600mm high x 1200mm wide. The boards must be oversailing the aperture by 100 mm on both sides of the wall, fixed to the wall with ≥ 100 mm wood screws and penny washers of steel at 300 mm centres. The gap between board and wall must have a bead of ACR 240. Exposed board edges must be coated with FPMF Coating.
- 10) Solutions in Annex A for 100 mm thick flexible walls with double layer 50 mm thick boards, can be used in 75 mm thick flexible and rigid walls with a maximum aperture of 1,200mm high x 900mm wide, limited to EI 60 unless specified otherwise in Annex A. The boards must be positioned centrally within the wall, and any exposed mineral fibres must be coated with FPMF Coating.
- 11) The provisions made in this European Technical Assessment are based on an assumed working life of the FPMF Board of 25 years, provided that the conditions laid down in the product datasheet for the packaging/transport/ storage/installation/use/repair are met. The indications given on the working life cannot be interpreted as a guarantee given by the producer or the Technical Assessment Body but are to be regarded only as a means for choosing the right products in relation to the expected economically reasonable working life of the works.
- 12) Type Y<sub>1</sub>: intended for use at temperatures below 0°C with exposure to UV but no exposure to rain. Includes lower classes Y<sub>2</sub>, Z<sub>1</sub>, Z<sub>2</sub>.

**3 Performance of the product and references to the methods used for its assessment**

Product-type: Sealant	Intended use: Penetration Seal
Essential characteristic	Product Performance
<b>BWR 2 Safety in case of fire</b>	
Reaction to fire	D – s1, d0
Resistance to fire	Annex A
<b>BWR 3 Hygiene, health and environment</b>	
Air permeability	Annex B
Water permeability	No performance assessed
Release of dangerous substances	Declaration of manufacturer
<b>BWR 4 Safety in use</b>	
Mechanical resistance and stability	No performance assessed
Resistance to impact/movement	No performance assessed
Adhesion	No performance assessed
Durability	Y <sub>1</sub>
<b>BWR 5 Protection against noise</b>	
Airborne sound insulation	29 (-1;-3) dB <sup>1</sup> 29 (0;-2) dB <sup>2</sup> 52 (-4;-7) dB <sup>3</sup> 53 (-4;-7) dB <sup>4</sup>
<b>BWR 6 Energy economy and heat retention</b>	
Thermal properties	No performance assessed
Water vapour permeability	No performance assessed

<sup>1</sup> Single 50mm FPMF Board 2-S.<sup>2</sup> Single 60mm FPMF Board 2-S<sup>3</sup> Double 50 or 60mm FPMF Board 1-S or 2-S<sup>4</sup> Double 50 or 60mm FPMF Board 1-S or 2-S with 50mm cavity

**4 ASSESSMENT AND VERIFICATION OF CONSTANCY OF PERFORMANCE (HEREINAFTER AVCP) SYSTEM APPLIED, WITH REFERENCE TO ITS LEGAL BASE**

According to the decision 1999/454/EC – Commission Decision of date 22nd June 1999 on the procedure for attesting the conformity of construction products pursuant to Article 20(2) of Council Directive 89/106/EEC as regards fire stopping, fire sealing and fire protective products, published in the Official Journal of the European Union (OJEU) L178/52 of 14/07/1999, (see <https://eur-lex.europa.eu/oj/direct-access.html>) of the European Commission<sup>1</sup>, as amended, the system(s) of assessment and verification of constancy of performance (see Annex V to Regulation (EU) No 305/2011) given in the following table(s) applies (apply).

Product(s)	Intended use(s)	Level(s) or class(es)	System(s)
Fire stopping and Fire Sealing Products	For fire compartmentation and/or fire protection or fire performance	Any	1

**5 Technical details necessary for the implementation of the AVCP system, as provided for in the applicable EAD**

Technical details necessary for the implementation of the AVCP system are laid down in the control plan deposited at ETA-Danmark A/S prior to CE marking

Issued in Copenhagen on 2022-03-04 by



Thomas Bruun

Managing Director, ETA-Danmark

---

<sup>1</sup> Official Journal of the European Communities L178/52 of 14/7/1999



## ANNEX A – Resistance to Fire Classification – FPMF Board

### A.1 Rigid wall constructions according to 2. 2)

#### A.1.1 Cable penetration seal with 2x 60 mm thick FPMF Board 2-S in minimum 150 mm thick walls

**Penetration Seal:** Cables fitted at any position within the aperture, with 60 mm FPMF Board 2-S to both sides of the wall.

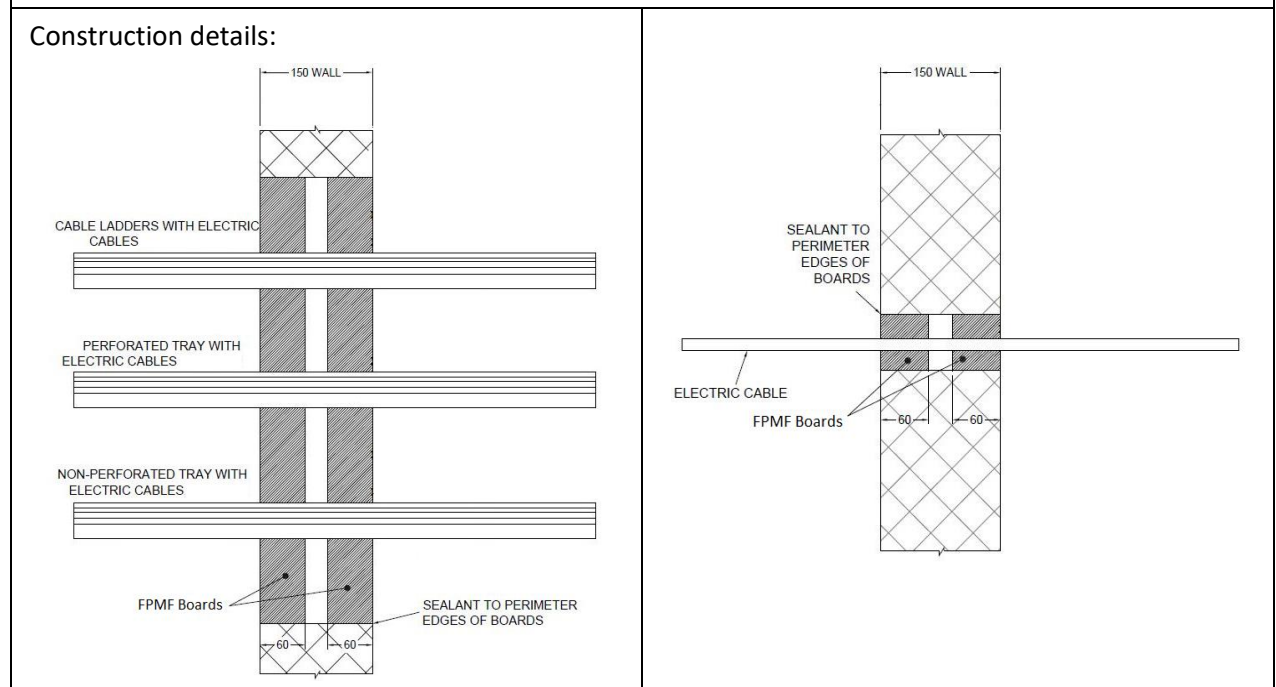

#### A.1.1.1 Double side penetration seal with cables

Services	Classification
None (blank), at max. 1200 x 1200 mm	EI 240
None (blank)	E 240, EI 180
Single electrical cables up to 21 mm $\varnothing$	
Single or bundled electrical cables up to 21 mm $\varnothing$ , with or without trays	E 240, EI 180
Electrical cables up to 80 mm $\varnothing$ (single, bundled and on trays)	E 180, EI 60
Cables up to 21mm $\varnothing$ in tied bundles up to 100mm $\varnothing$	E 180, EI 120
Steel cable trays & ladders	E 180, EI 60
Plastic conduits up to 16 mm $\varnothing$	EI 180 C/U, EI 180 C/C

**A.1.2 Cable penetration seal with 1x 60 mm thick FPMF Board 2-S**

**Penetration Seal:** Cables (single) fitted at any position within the aperture, with FPMF Board 2-S positioned to either face of the wall (or anywhere in between).

Construction details:

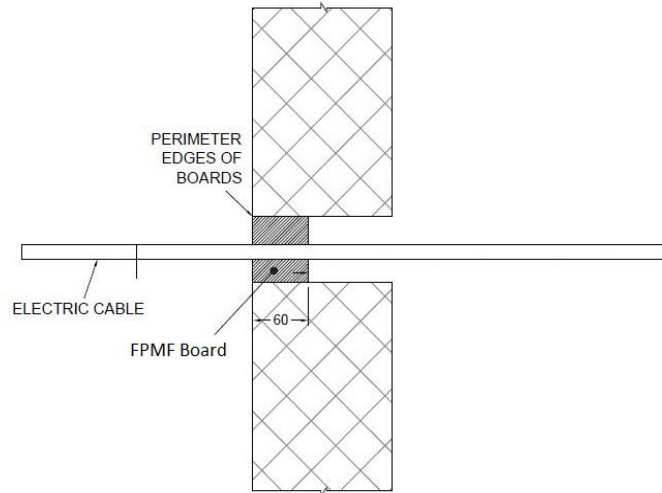

**A.1.2.1 Single side penetration seal with cables in minimum 150 mm thick walls**

Services	Maximum aperture	Classification
None (blank)	As section 2. 5)	<b>E 240, EI 90</b>
Single electrical cables up to 21 mm $\varnothing$		
Single A1 cable = 5 x 1.5 mm <sup>2</sup> core HD603.3 electrical cable with PVC insulation, PVC sheath and 14 mm diameter	70 x 70 mm	<b>EI 240</b>
Single A2 cable = 5 x 1.5 mm <sup>2</sup> core HD22.4 electrical cable with EPR insulation, PO sheath and 11.2-14.4 mm diameter		
Single A3 cable = 5 x 1.5 mm <sup>2</sup> core HD604.5 electrical cable with XLPE insulation, EVA sheath and 13 mm diameter		

**A.1.2.2 Single side penetration seal with cables in minimum 75 mm thick walls**

Services	Maximum aperture	Classification
None (blank)	As section 2. 5)	<b>E 120, EI 90</b>
Single electrical cables up to 21 mm $\varnothing$		

**A.1.3 Pipe penetration seal with 2x 60 mm thick FPMF Board 2-S**

**Penetration Seal:** 1000 mm (min.) LI (Local Interrupted) or CI (Continuous Interrupted) insulated metallic pipes (single) fitted at any position within the aperture, with 60 mm FPMF Board to both sides of the wall in minimum 150 mm thick walls.

Construction details:

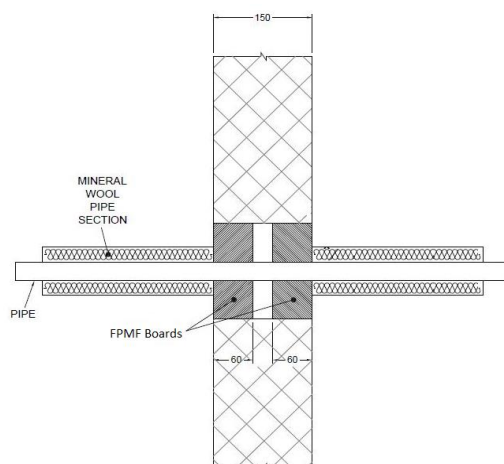
**A.1.3.1 Double side penetration seal with pipes**

Services	Maximum aperture	Insulation, minimum thickness and density	Classification
Mild or stainless steel pipe			
40 mm diameter/1.5-14.2 mm wall*	1200 x 1200 mm	20 mm Stone wool insulation 80 kg/m <sup>3</sup>	EI 240 C/U
40 mm diameter/1.5-14.2 mm wall*	As section 2. 5)	30 mm Stone wool insulation 80 kg/m <sup>3</sup>	E 240 C/U, EI 180 C/U
40 mm diameter/1.5-14.2 mm wall*			
50 mm diameter/1.7-14.2 mm wall*			
60 mm diameter/1.9-14.2 mm wall*			
75 mm diameter/2.2-14.2 mm wall*			
90 mm diameter/2.5-14.2 mm wall*			
100 mm diameter/2.7-14.2 mm wall*			
115 mm diameter/3-14.2 mm wall*			
140 mm diameter/3.5-14.2 mm wall*			
165 mm diameter/ 3.9-14.2 mm wall*			
180 mm diameter/ 4.2-14.2 mm wall*			
200 mm diameter/ 4.6-14.2 mm wall*			
219 mm diameter/ 5.0-14.2 mm wall*			

\* Typical pipe diameters shown, see below graph for intermediate sizes

Services	Maximum aperture	Insulation, minimum thickness and density	Classification
Alupex composite			
16 mm diameter/2.25 mm wall	1200 x 1200 mm	20 mm Stone wool insulation 80 kg/m <sup>3</sup>	EI 240 U/C
16 mm diameter/2.25 mm wall	As section 2. 5)		E 240 U/C EI 180 U/C
Copper pipe			
Up to 54 mm diameter Copper or steel pipe 0.9-14.2 mm wall	As section 2. 5)	20 mm Stone wool insulation 80 kg/m <sup>3</sup>	E 240 C/U, EI 120 C/U

Pipe diameter vs Wall thickness

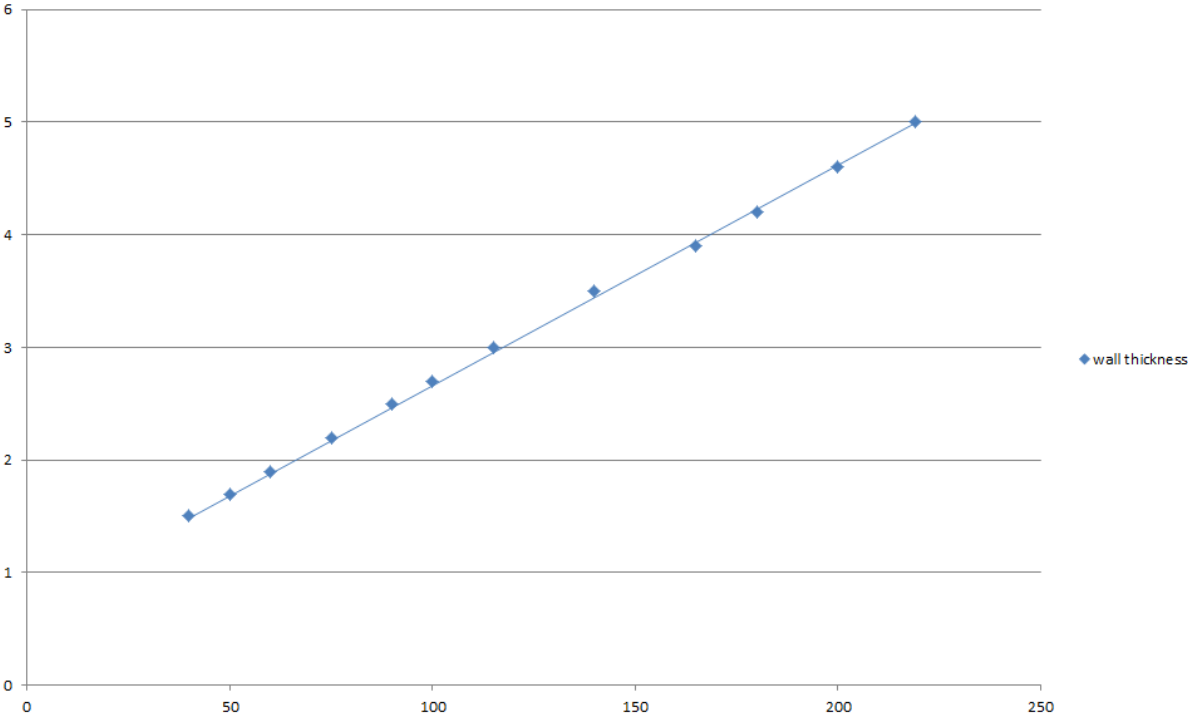

### A.1.4 Pipe penetration seal with 2x FPMF Board 2-S

**Penetration Seal:** CS (Continuous Sustained) insulated metallic pipes fitted at any position within the aperture, with 60 mm FPMF Board 2-S to both sides of the wall. Minimum separation between penetration seals and seal edges of 30 mm in minimum 150 mm thick walls.

Construction details:

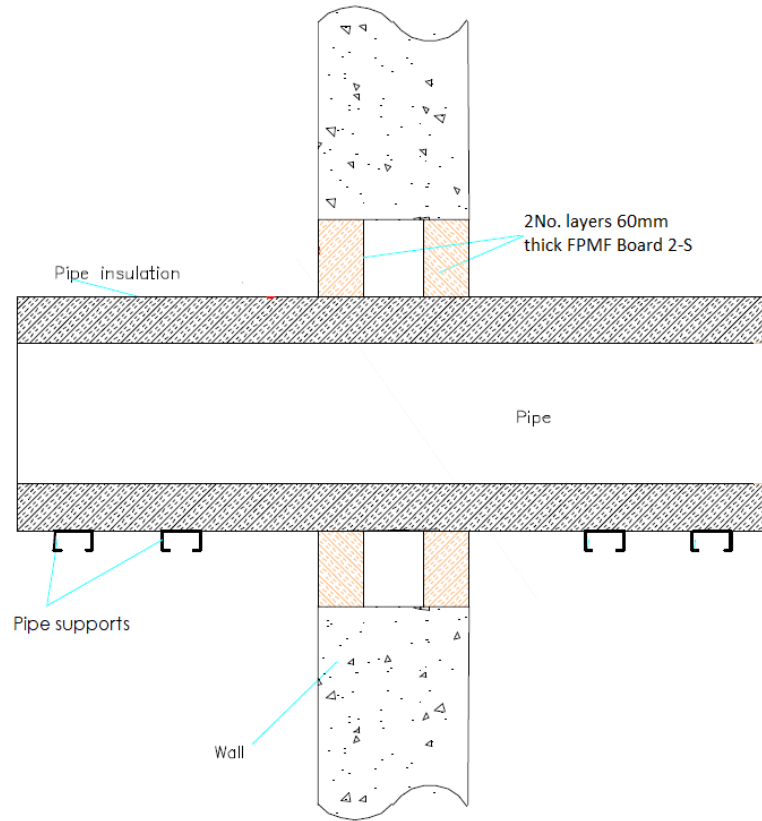

**Configuration 1**

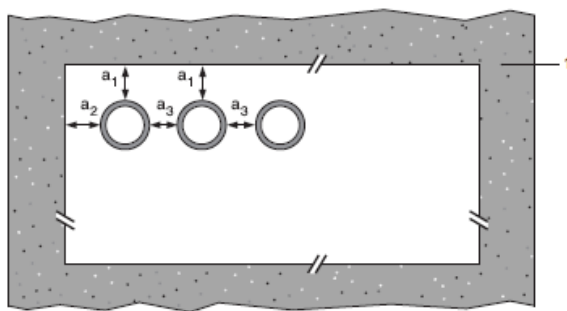

**Configuration 2**

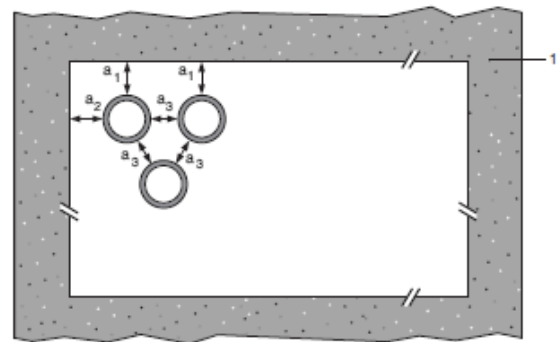

**Key**

- 1 Supporting construction
- a1 Pipe / top edge of seal separation
- a2 Pipe / side edge of seal separation
- a3 Pipe / pipe separation

**A.1.4.1 Double side penetration seal with pipes**

Services	Insulation	Classification
Mild or stainless steel pipe		
40 mm diameter/1-14.2 mm wall	20 mm thick stone, mineral wool 80 kg/m <sup>3</sup>	<b>E 240 C/U, EI 180 C/U</b>
40 mm diameter/1-14.2 mm wall*	30-80 mm thick stone, mineral wool min. 80 kg/m <sup>3</sup>	
50 mm diameter/1.2-14.2 mm wall*		
60 mm diameter/1.4-14.2 mm wall*		
75 mm diameter/1.6-14.2 mm wall*		
90 mm diameter/1.9-14.2 mm wall*		
100 mm diameter/2.1-14.2 mm wall*		
115 mm diameter/2.4-14.2 mm wall*		
140 mm diameter/2.9-14.2 mm wall*		
165 mm diameter/ 3.4-14.2 mm wall*		
180 mm diameter/ 3.6-14.2 mm wall*		
200 mm diameter/ 4.0-14.2 mm wall*		
219 mm diameter/ 4.3-14.2 mm wall*		
250 mm diameter/ 5.0-14.2 mm wall*		
300 mm diameter/ 5.9-14.2 mm wall*		
324 mm diameter/ 6.35-14.2 mm wall*		

**Pipe Diameter vs wall thickness**

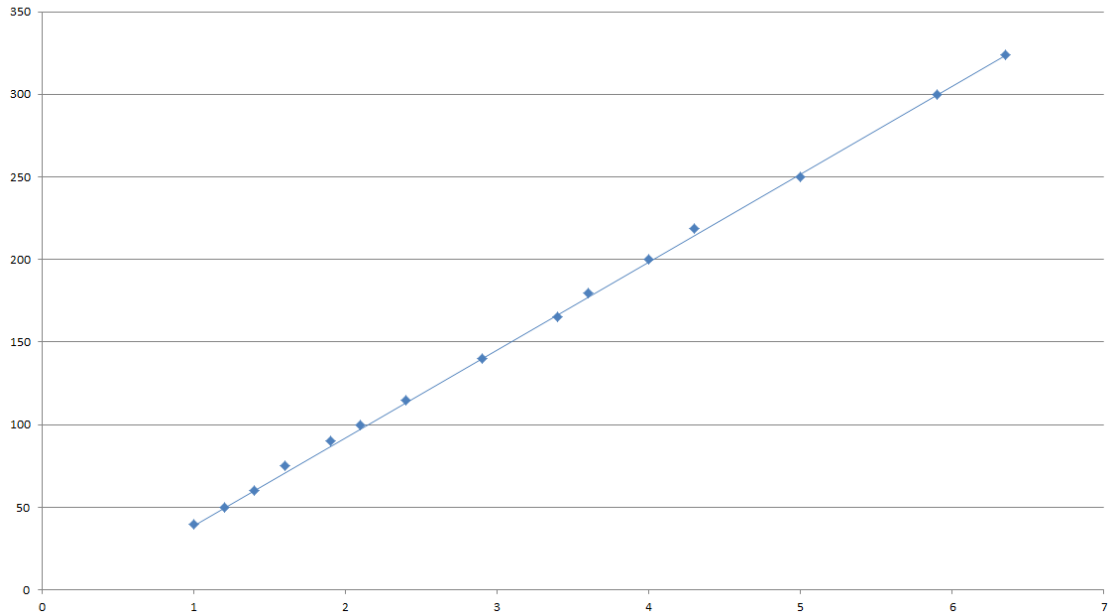

### A.1.5 Pipe penetration seal with 1x 60 mm thick FPMF Board 2-S

**Penetration Seal:** 1000 mm (min.)\* LI (Local Interrupted), CI (Continuous Interrupted) or CS (continuous sustained) insulated metallic and composite pipes (single) fitted at any position within the aperture, with 60 mm FPMF Board to one side of the wall.

Construction details:

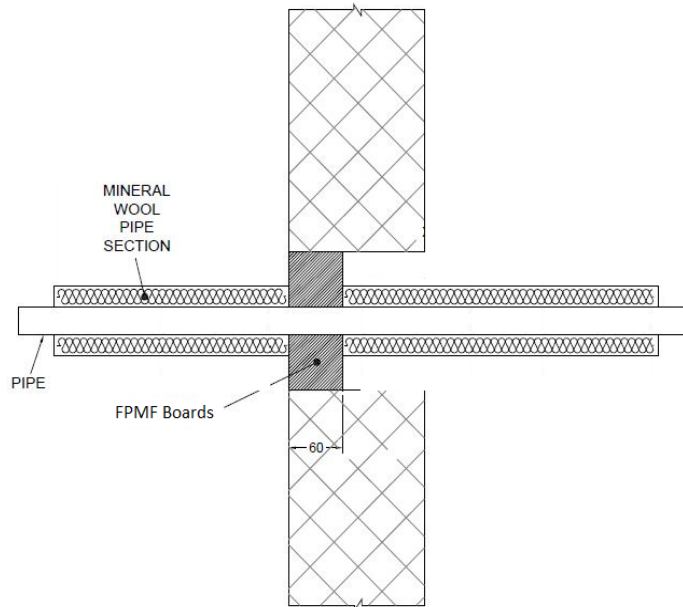

\* 600 mm long insulation required for Alupex pipes

#### A.1.5.1 Single side penetration seal with pipes in minimum 150 mm thick walls

Services	Maximum Aperture	Insulation, minimum thickness and density	Classification
Up to 12 mm diameter Copper or steel pipe 0.9-14.2 mm wall	70 x 70 mm	20 mm Stone wool insulation 80 kg/m <sup>3</sup>	EI 240 C/U
Up to 54 mm diameter Copper or steel pipe 0.9-14.2 mm wall	115 x 115 mm		E 240 C/U, EI 120 C/U
75 mm diameter Alupex composite pipe 7.5 mm wall	200 x 200 mm	30 mm Stone wool insulation 80 kg/m <sup>3</sup>	EI 120 C/C
Up to 54 mm diameter Copper or steel pipe 0.9-14.2 mm wall	As section 2. 5)	20 mm Stone wool insulation 80 kg/m <sup>3</sup>	E 240 C/U, EI 90 C/U
Up to 75 mm diameter Alupex composite pipe 7.5 mm wall		30 mm Stone wool insulation 80 kg/m <sup>3</sup>	E 120 C/C, EI 90 C/C
325 mm diameter Steel pipe*		30 mm Stone wool insulation 80 kg/m <sup>3</sup>	E 120 C/U, EI 90 C/U

\* Typical pipe diameters shown, see below graph for intermediate sizes

### Mild or Stainless Steel Pipes - E 120 C/U, EI 90 C/U

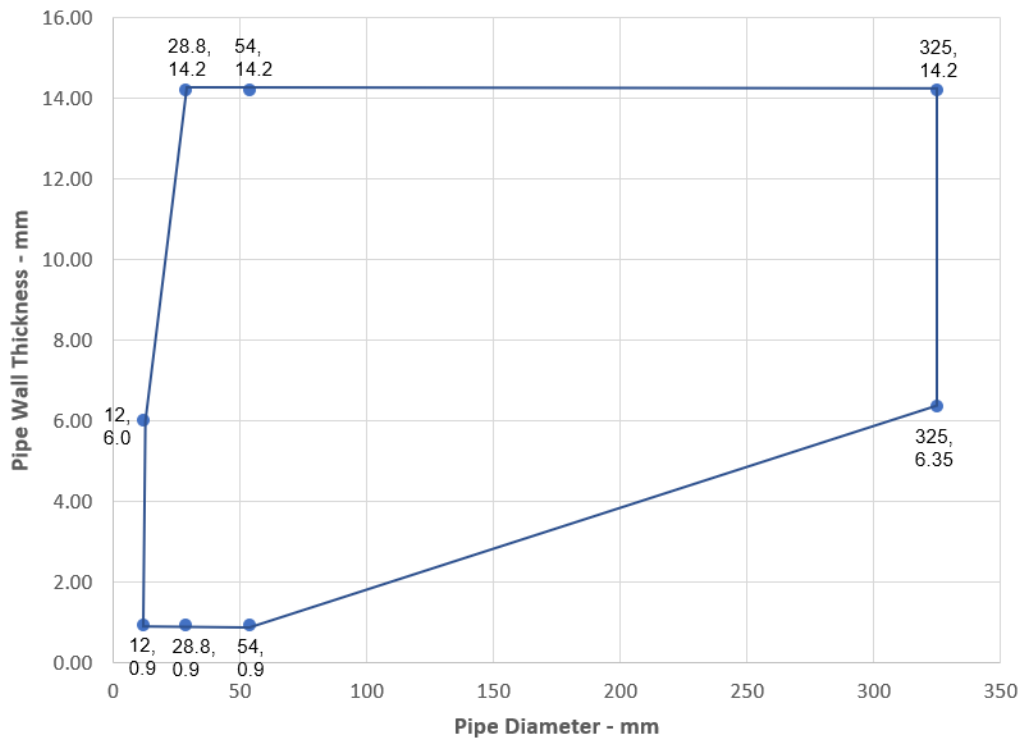



Services	Maximum Aperture	Insulation, minimum thickness and density	Classification
Mild or stainless steel pipe			
40 mm diameter/1.5-14.2 mm wall*	280 x 280 mm	20 mm Stone wool insulation 80 kg/m <sup>3</sup>	EI 240 C/U
40 mm diameter/1.5-14.2 mm wall*		30 mm Stone wool insulation 80 kg/m <sup>3</sup>	
50 mm diameter/1.7-14.2 mm wall*			
60 mm diameter/1.9-14.2 mm wall*			
75 mm diameter/2.2-14.2 mm wall*			
90 mm diameter/2.5-14.2 mm wall*			
100 mm diameter/2.7-14.2 mm wall*			
115 mm diameter/3-14.2 mm wall*			
140 mm diameter/3.5-14.2 mm wall*			
165 mm diameter/ 3.9-14.2 mm wall*			
180 mm diameter/ 4.2-14.2 mm wall*			
200 mm diameter/ 4.6-14.2 mm wall*			
219 mm diameter/ 5.0-14.2 mm wall*			
40 mm diameter/1.5-14.2 mm wall*	As section 2. 5)	20 mm Stone wool insulation 80 kg/m <sup>3</sup>	E 240 C/U, EI 90 C/U
50 mm diameter/1.7-14.2 mm wall*		30 mm Stone wool insulation 80 kg/m <sup>3</sup>	
60 mm diameter/1.9-14.2 mm wall*			
75 mm diameter/2.2-14.2 mm wall*			
90 mm diameter/2.5-14.2 mm wall*			
100 mm diameter/2.7-14.2 mm wall*			
115 mm diameter/3-14.2 mm wall*			
140 mm diameter/3.5-14.2 mm wall*			
165 mm diameter/ 3.9-14.2 mm wall*			
180 mm diameter/ 4.2-14.2 mm wall*			
200 mm diameter/ 4.6-14.2 mm wall*			
219 mm diameter/ 5.0-14.2 mm wall*			

\* Typical pipe diameters shown, see below graph for intermediate sizes

**Pipe diameter vs Wall thickness**

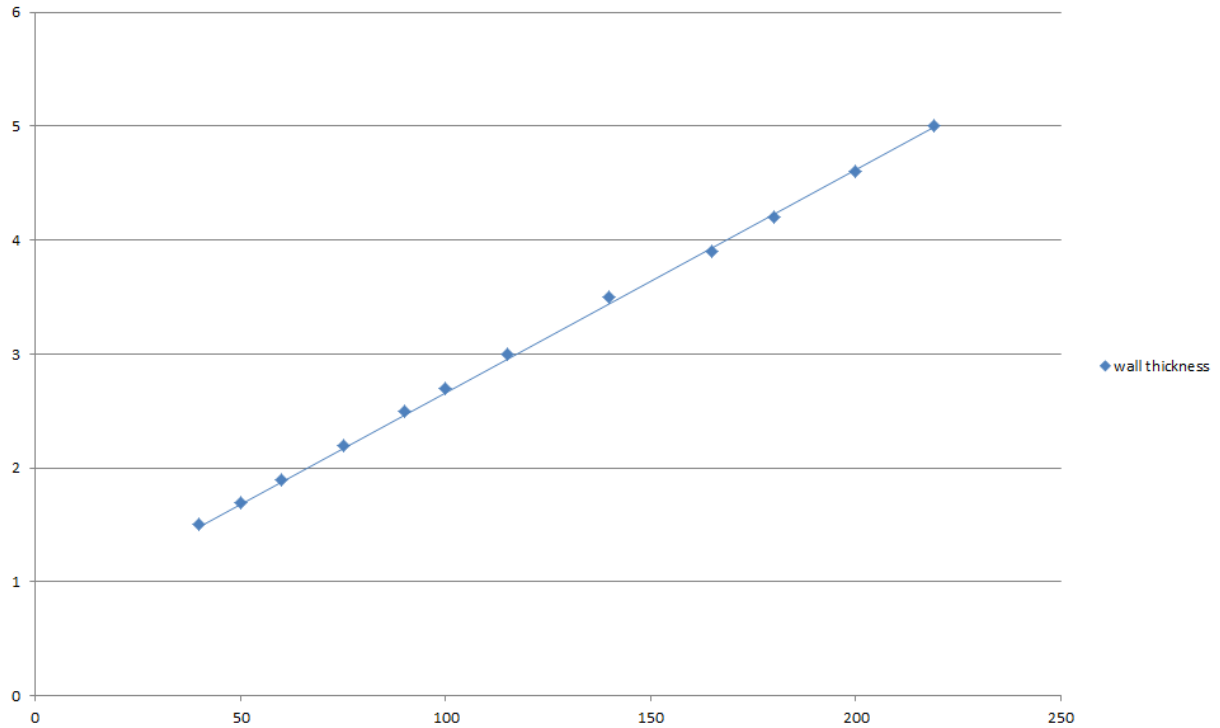

**A.1.5.2 Single side penetration seal with pipes in minimum 75 mm thick walls**

Services	Maximum Aperture	Insulation, minimum thickness and density	Classification
Up to 54 mm diameter Copper or steel pipe 0.9-14.2 mm wall	As section 2. 5)	20 mm Stone wool insulation 80 kg/m <sup>3</sup>	<b>E 120 C/U, EI 90 C/U</b>
Up to 75 mm diameter Alupex composite pipe 7.5 mm wall		30 mm Stone wool insulation 80 kg/m <sup>3</sup>	<b>E 120 C/C, EI 90 C/C</b>
325 mm diameter Steel pipe*			<b>E 120 C/U, EI 90 C/U</b>

\* Typical pipe diameters shown, see below graph for intermediate sizes

### Mild or Stainless Steel Pipes - E 120 C/U, EI 90 C/U

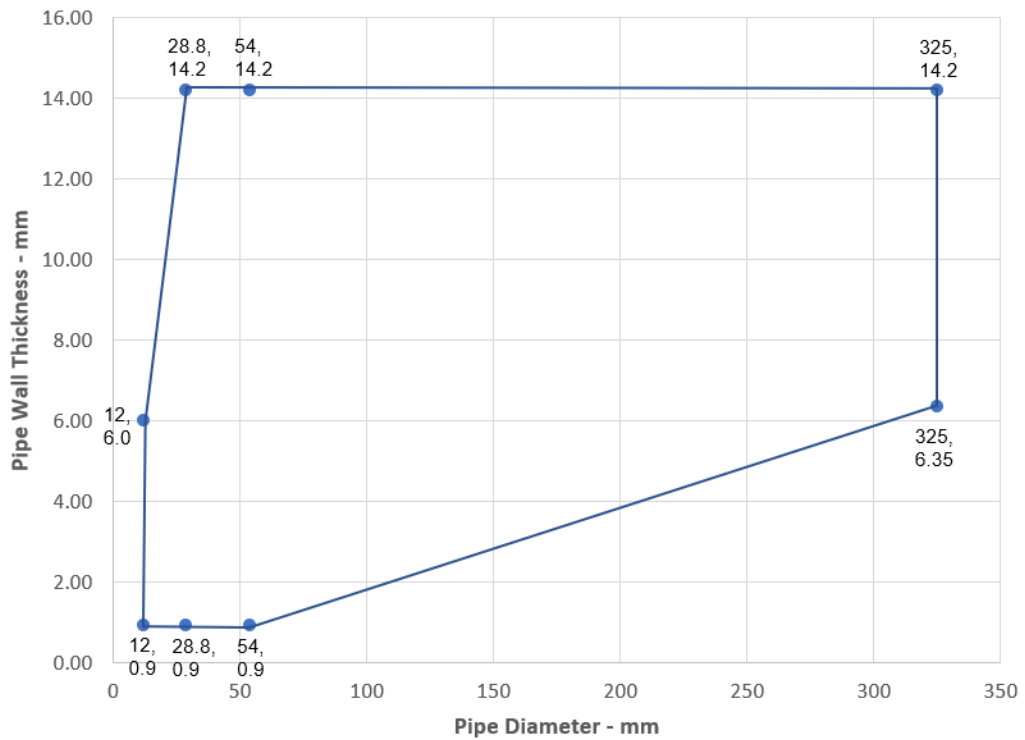

Services	Maximum Aperture	Insulation, minimum thickness and density	Classification
Mild or stainless steel pipe			
40 mm diameter/1.5-14.2 mm wall*	As section 2. 5)	20 mm Stone wool insulation 80 kg/m <sup>3</sup>	<b>E 120 C/U, EI 90 C/U</b>
50 mm diameter/1.7-14.2 mm wall*		30 mm Stone wool insulation 80 kg/m <sup>3</sup>	
60 mm diameter/1.9-14.2 mm wall*			
75 mm diameter/2.2-14.2 mm wall*			
90 mm diameter/2.5-14.2 mm wall*			
100 mm diameter/2.7-14.2 mm wall*			
115 mm diameter/3-14.2 mm wall*			
140 mm diameter/3.5-14.2 mm wall*			
165 mm diameter/ 3.9-14.2 mm wall*			
180 mm diameter/ 4.2-14.2 mm wall*			
200 mm diameter/ 4.6-14.2 mm wall*			
219 mm diameter/ 5.0-14.2 mm wall*			

\* Typical pipe diameters shown, see below graph for intermediate sizes

Pipe diameter vs Wall thickness

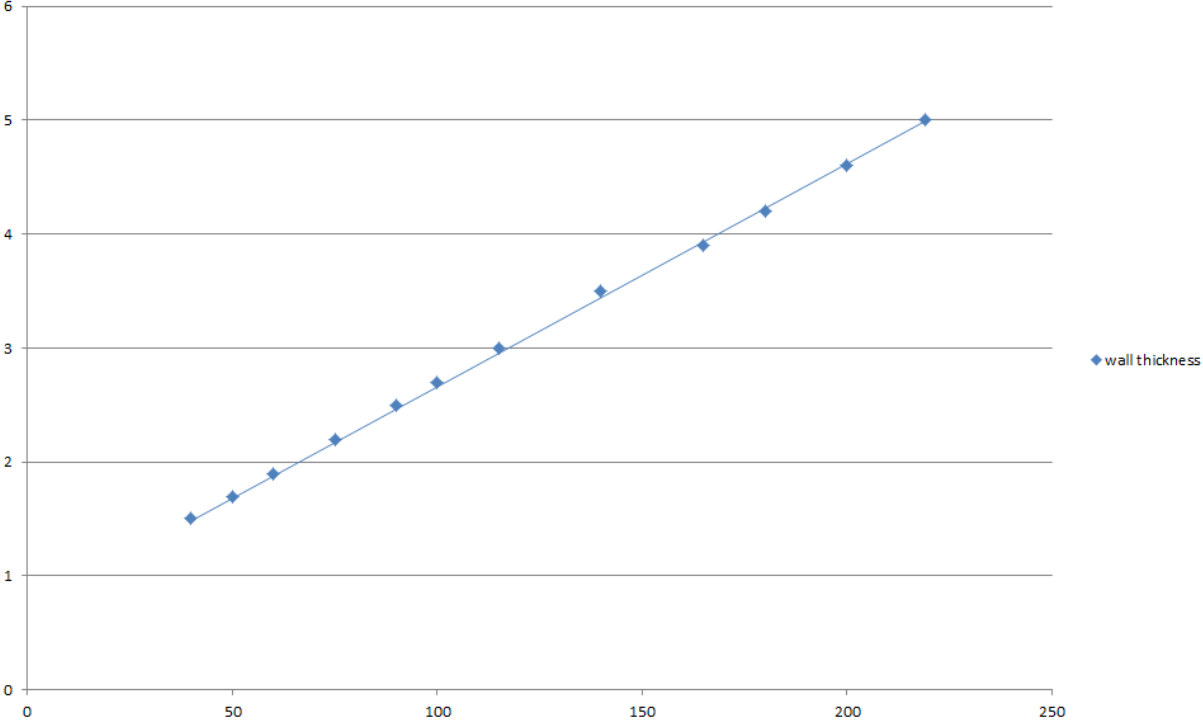

### A.1.6 Pipe penetration seal with 1x FPMF Board 2-S

**Penetration Seal:** CS (Continuous Sustained) insulated metallic pipes fitted at any position within the aperture, with 60 mm FPMF Board 2-S to either side of the wall (or anywhere in between). FP Pipe Wraps are required to be fitted around combustible pipe insulation.

Construction details:

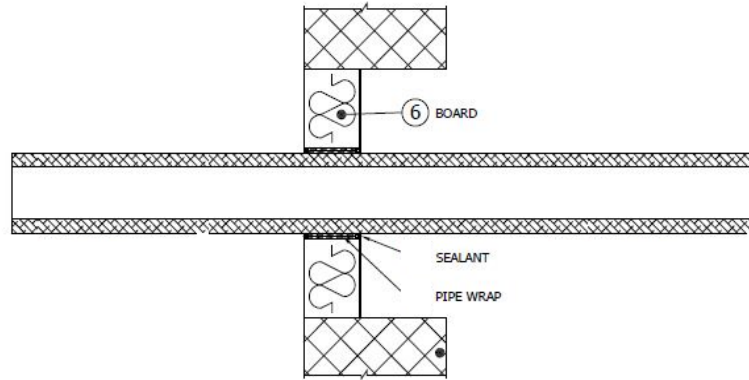

#### A.1.6.1 Single side penetration seal with pipes in minimum 150 mm thick walls

Services	Wrap	Insulation	Classification
Mild or stainless steel pipe			
165 mm diameter/ 4.5-14.2 mm wall	50 x 1.8 mm FP Pipe Wrap fitted centrally	9-25 mm elastomeric insulation min. class B-s3, d0	E 120 U/C, E 120 C/U, E 120 C/C, EI 45 U/C, EI 45 C/U, EI 45 C/C
40-219 mm diameter*	Not required	30 mm stone wool min. 80 kg/m <sup>3</sup>	E 240 U/C, E 240 C/U, E 240 C/C, EI 60 U/C, EI 60 C/U, EI 60 C/C
40-219 mm diameter*		30-50 mm stone wool min. 80 kg/m <sup>3</sup>	E 180 U/C, E 180 C/U, E 180 C/C, EI 60 U/C, EI 60 C/U, EI 60 C/C
40-325 mm diameter*		50 mm stone wool min. 80 kg/m <sup>3</sup>	E 180 U/C, E 180 C/U, E 180 C/C, EI 60 U/C, EI 60 C/U, EI 60 C/C

\* Typical pipe diameters shown, see below graph for intermediate sizes

### Pipe diameter vs Wall thickness

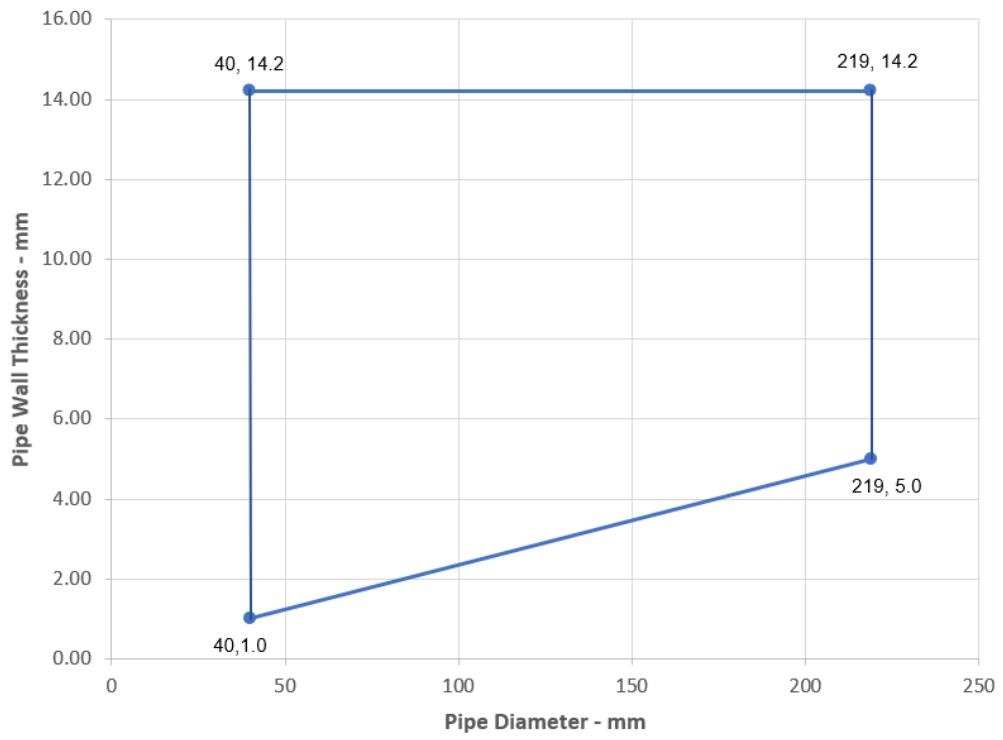

### Pipe diameter vs Wall thickness

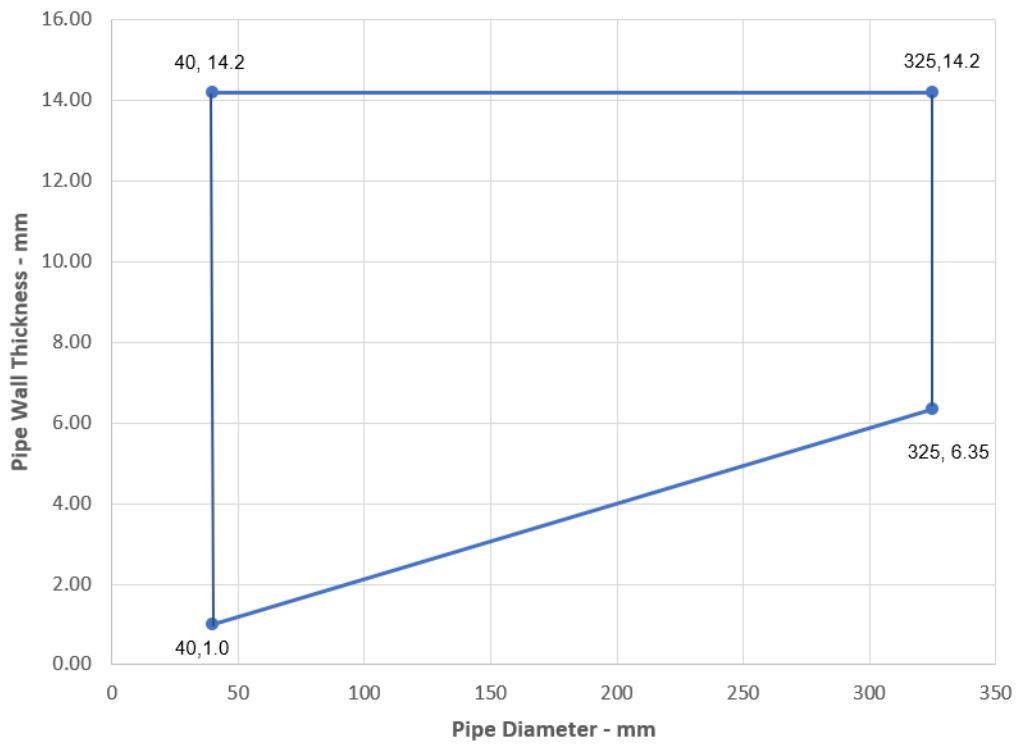

**A.1.6.2 Single side penetration seal with pipes in minimum 75 mm thick walls**

**Single side penetration seal with pipes**

Services	Wrap	Insulation	Classification
Mild or stainless steel pipe			
165 mm diameter/ 4.5-14.2 mm wall	50 x 1.8 mm FP Pipe Wrap fitted centrally	9-25 mm elastomeric insulation min. class B-s3, d0	E 120 U/C, E 120 C/U, E 120 C/C, EI 45 U/C, EI 45 C/U, EI 45 C/C
40-219 mm diameter*	Not required	30-50 mm stone wool min. 80 kg/m <sup>3</sup>	E 120 U/C, E 120 C/U, E 120 C/C, EI 60 U/C, EI 60 C/U, EI 60 C/C
40-325 mm diameter*		50 mm stone wool min. 80 kg/m <sup>3</sup>	E 120 U/C, E 120 C/U, E 120 C/C, EI 60 U/C, EI 60 C/U, EI 60 C/C

\* Typical pipe diameters shown, see below graph for intermediate sizes

**Pipe diameter vs Wall thickness**

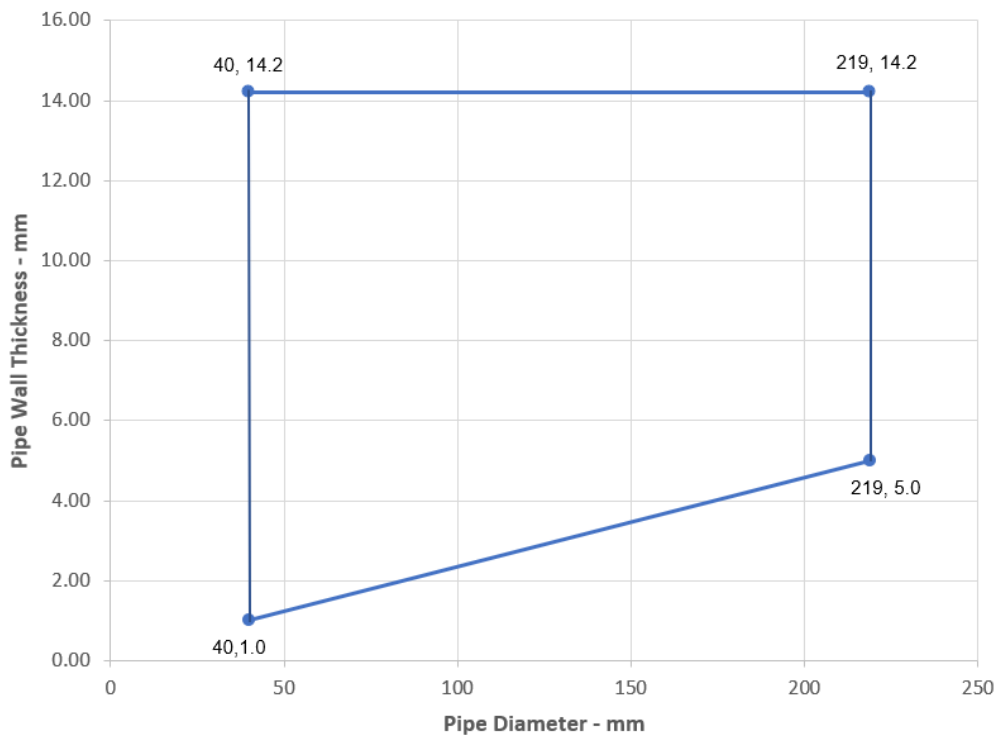

### Pipe diameter vs Wall thickness

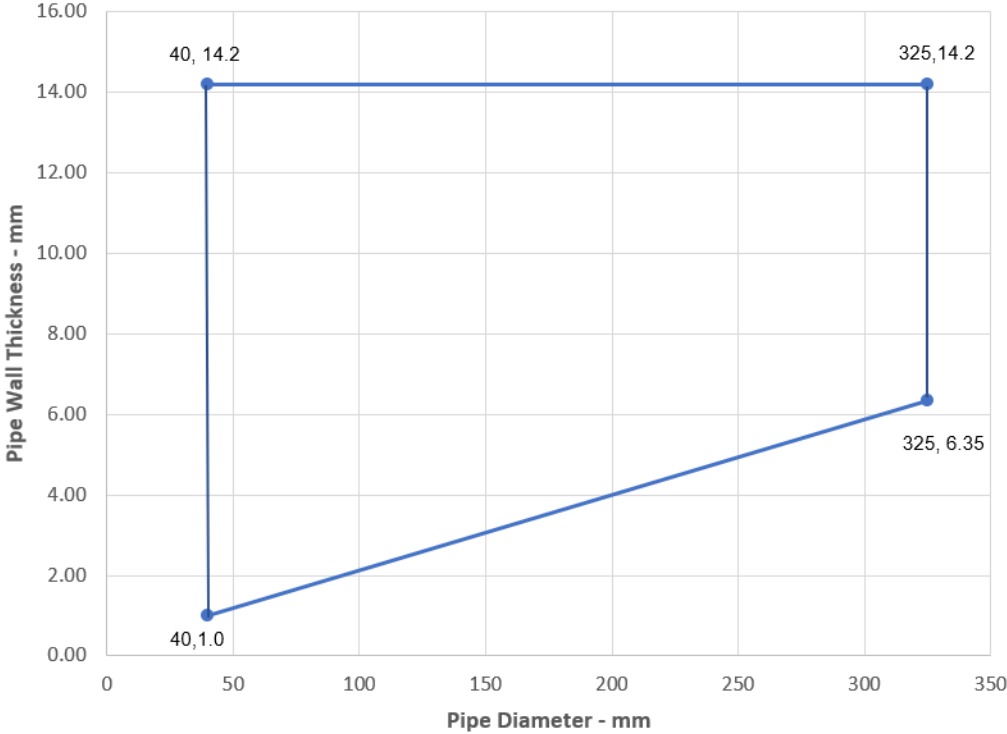



**A.1.7 FPMF Board 60 mm 2-S penetration seal (protruding) blank and with cables, in rigid wall min. 150 mm thick**

**Penetration Seal:** Cables fitted at any position within the aperture, with 60 mm FPMF Board 2-S to both sides of the wall. Boards to be separated by minimum 90 mm.

Construction details:

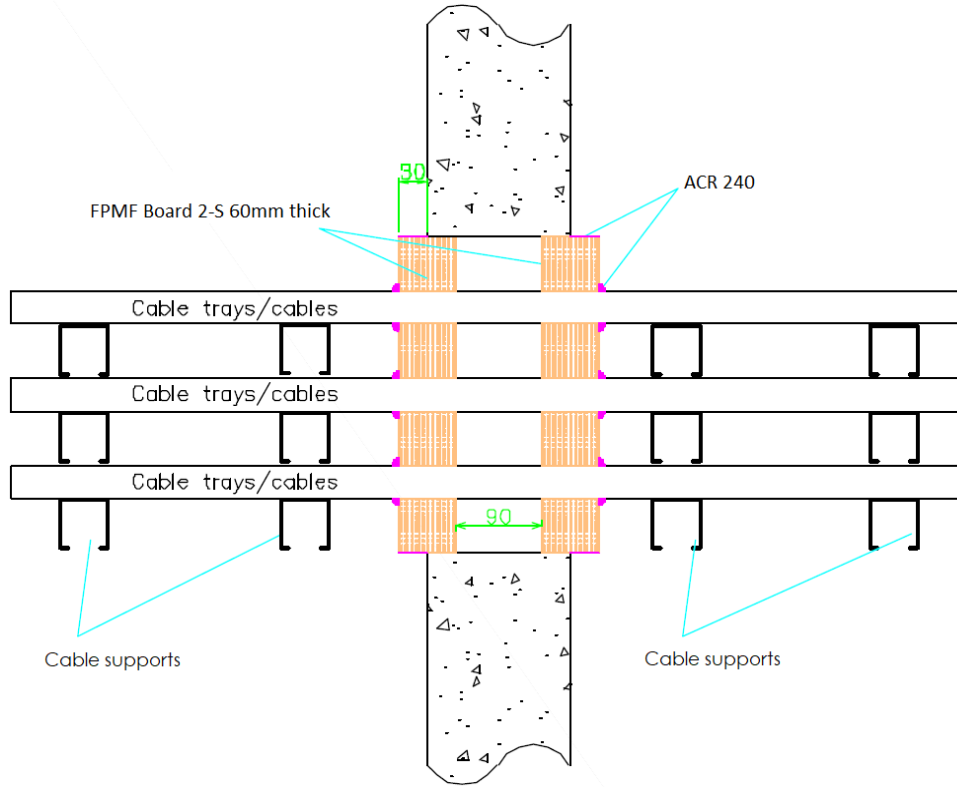

**A.1.7.1 Two side penetration seal with cables**

Services	Maximum aperture	Classification
None (blank)	600 mm wide x 600 mm high	E 240, EI 180
Single or bundled electrical cables up to 21 mm $\varnothing$ , with or without trays		E 240, EI 120
Electrical cables up to 80 mm $\varnothing$ (single, bundled and on trays)		E 240, EI 60
Cables up to 21mm $\varnothing$ in tied bundles up to 100mm $\varnothing$		EI 240
Steel cable trays & ladders		E 240, EI 180
Non-Sheathed wires up to 17 mm $\varnothing$		E 240, EI 180
Non-Sheathed wires up to 24 mm $\varnothing$		E 240, EI 90

**A.1.8 FPMF Board 60 mm 2-S penetration seal (pattress) blank and with cables, in rigid wall min. 150 mm thick**

**Penetration Seal:** Cables fitted at any position within the aperture, with 60 mm FPMF Board 2-S to both sides of the wall. Boards to be pattress fixed with 100 mm steel screws and penny washers at 350 mm centres and with a minimum 50 mm overlap around the opening.

Construction details:

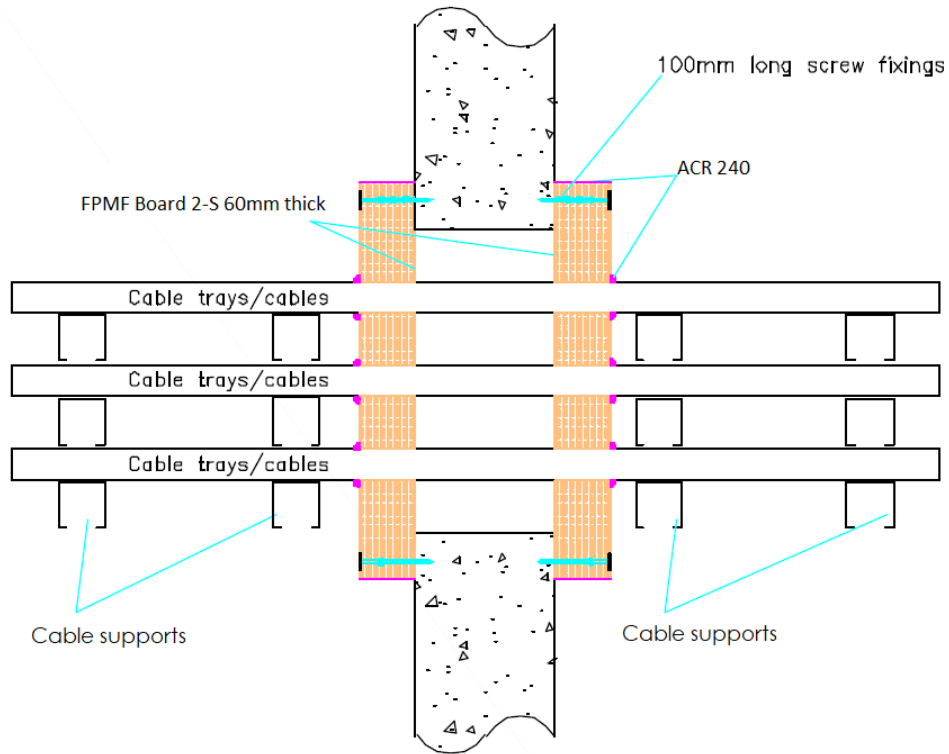

**A.1.8.1 Two side penetration seal with cables**

Services	Maximum aperture	Classification
None (blank)	600 mm wide x 600 mm high	E 240, EI 180
Single or bundled electrical cables up to 50 mm $\varnothing$ , with or without trays		E 240, EI 90
Single or bundled electrical cables up to 80 mm $\varnothing$ (single, bundled and on trays)		E 240, EI 60
Cables up to 21mm $\varnothing$ in tied bundles up to 100mm $\varnothing$		EI 240
Steel cable trays & ladders		E 240, EI 180
Non-Sheathed wires up to 24 mm $\varnothing$		E 240, EI 120

**A.1.9 Penetration seal with 2x FPMF Board 2-S**

**Penetration Seal:** Plastic pipes fitted at any position within the aperture, with 60 mm FPMF Board 2-S to both sides of the wall. FP Pipe Wraps are required to be fitted around pipes. Min. 30 mm separation between pipes in minimum 150 mm thick walls.

Construction details:

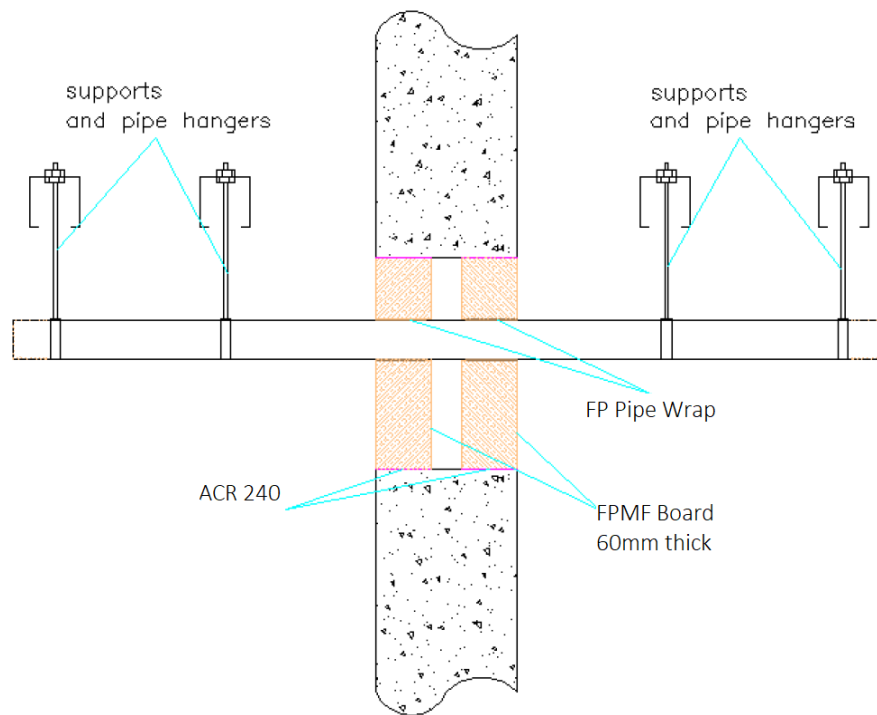
**A.1.9.1 Double side penetration seal with pipes**

Services	Wrap	Classification
PVC-U pipe according to EN 1329-1, EN 1452-1 and EN 1453-1 and PVC-C according to EN 1566-1		
Up to 32 mm diameter / 1.0-2.4 mm wall <sup>^</sup>	None	<b>EI 240 U/C</b>
Up to 40 mm diameter / 1.9-3.0 mm wall	50 x 1.8 mm	
Up to 110 mm diameter / 2.7-6.6 mm wall	50 x 3.6 mm	
Up to 125 mm diameter / 4.7-7.4 mm wall	50 x 7.2 mm	
Up to 160 mm diameter / 4.0-9.5 mm wall*	50 x 10.8 mm	
Up to 200 mm diameter / 4.9-11.9 mm wall*	75 x 10.8 mm	<b>EI 180 C/C</b>
Up to 315 mm diameter/7.7-12.1 mm wall thickness*#	75 x 18 mm	<b>EI 120 C/C</b>
Up to 400 mm diameter/9.8-15.3 mm wall thickness*#	75 x 28.8 mm	<b>EI 120 C/C</b>
Diameter up to 32 mm Ø, wall thickness 1.0-2.4 mm in pipe bundles up to 107 mm Ø <sup>1)</sup>	50 x 3.6 mm	<b>EI 240 U/C</b>
PE pipe according to EN 1519-1, EN 12201-2 and EN 12666-1, ABS according to EN 1455-1 and pipes made from SAN+PVC according to EN 1565-1		
Up to 40 mm diameter / 2.4-4.6 mm wall	50 x 1.8 mm	<b>EI 240 U/C</b>
Up to 110 mm diameter / 3.4-10.0 mm wall	50 x 3.6 mm	
Up to 125 mm diameter / 3.9-7.4 mm wall	50 x 7.2 mm	
Up to 160 mm diameter / 4.9-9.5 mm wall	50 x 10.8 mm	
Up to 200 mm diameter / 4.9-18.2 mm wall	75 x 10.8 mm	<b>EI 180 C/C</b>
Up to 315 mm diameter / 28.6 mm wall	75 x 18.0 mm	<b>E 180 C/C, EI 120 C/C</b>
Up to 400 mm diameter / 36.3 mm wall	75 x 28.8 mm	<b>EI 120 C/C</b>
Diameter up to 32 mm Ø, wall thickness 2.0-4.4 mm in pipe bundles up to 107 mm Ø <sup>1)</sup>	50 x 3.6 mm	<b>EI 240 C/U</b>

Services	Wrap	Classification
PP pipe according to EN 1451-1		
Up to 40 mm diameter / 1.8-5.5 mm wall	50 x 1.8 mm	EI 240 U/C
Up to 110 mm diameter / 2.7-10.0 mm wall	50 x 3.6 mm	EI 240 C/C
Up to 125 mm diameter / 3.1-11.4 mm wall	50 x 7.2 mm	
Up to 160 mm diameter / 4.9-14.6 mm wall	50 x 10.8 mm	
Up to 200 mm diameter / 4.9-18.2 mm wall	75 x 10.8 mm	EI 180 C/C
Diameter up to 32 mm $\varnothing$ , wall thickness 1.8-4.4 mm in pipe bundles up to 107 mm $\varnothing$ <sup>1)</sup>	50 x 3.6 mm	EI 240 C/U

<sup>1)</sup> PVC, PE and PP pipes can be mixed in the same bundle.

\* Typical pipe diameters shown, see below graph for intermediate sizes.

# Configuration 1 & 2

^Sealed with a bead of ACR 240 applied flush to the pipe and batt on the outer faces of the board

PVC-U Pipes - EI 120 C/C

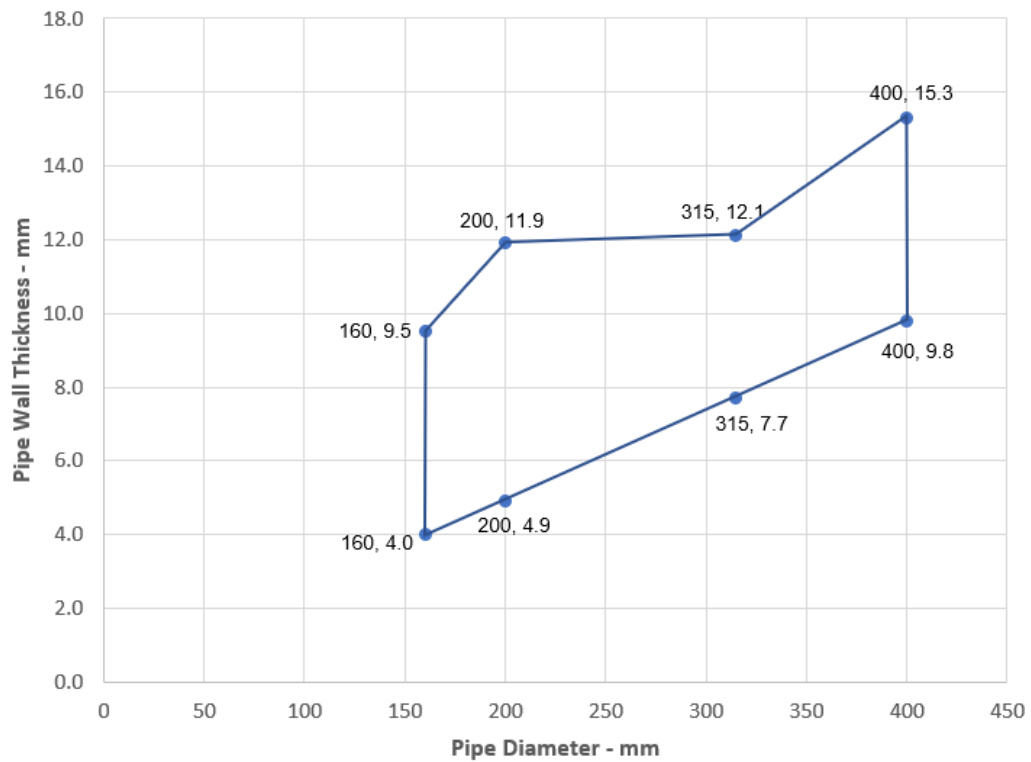

**A.2 Rigid floor constructions according to 2. 2) with floor thickness of minimum 150 mm**

**A.2.1 Cable penetration seal with 2x FPMF Board 2-S**

**Penetration Seal:** Cables fitted at any position within the aperture, with 60 mm FPMF Board 2-S to both sides of the floor.

Construction details:

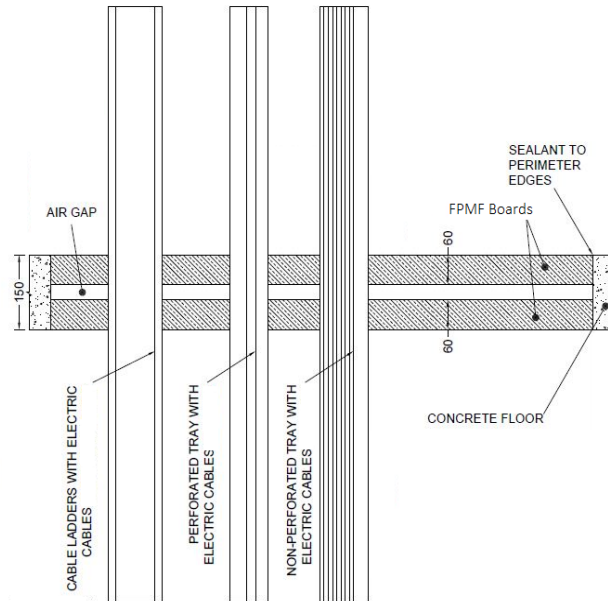

**A.2.1.1 Double side penetration seal with cables**

Services	Maximum aperture	Classification
None (blank)	1200 x 600 mm	EI 180
None (blank)	2400 mm x 1200 mm	E 180, EI 120
Electrical cables up to 21 mm $\varnothing$ (single, bundled and on trays)		EI 120
Electrical cables up to 80 mm $\varnothing$ (single, bundled and on trays)		E 120, EI 60
Cables up to 21mm $\varnothing$ in tied bundles up to 100mm $\varnothing$		EI 120
Steel cable trays & ladders		E 120, EI 60
Non-sheathed wires up to 24 mm $\varnothing$		E 180, EI 45
Plastic conduits up to 16 mm $\varnothing$		E 120 C/U, E 120 C/C, EI 90 C/U, EI 90 C/C

### A.2.2 Cable penetration seal with 1x FPMF Board 2-S

**Penetration Seal:** Cables fitted at any position within the aperture, with FPMF Board 2-S positioned to either face of the floor (or anywhere in between).

Construction details:

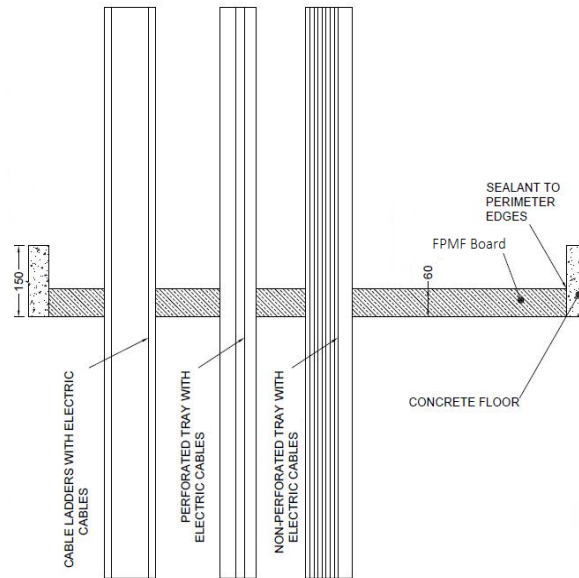

#### A.2.2.1 Single side penetration seal with cables

Services	Maximum aperture	Classification
None (blank)	1200 x 600 mm	E 240, EI 120
None (blank)	2400 mm x 1200 mm	E 120, EI 90
Single* electrical cables up to 21 mm $\varnothing$		E 120, EI 30
Single* electrical cables up to 21 mm $\varnothing$	600 mm x 1200 mm	E 240, EI 30
Electrical cables up to 21 mm $\varnothing$ (single, bundled and on trays)	2400 mm x 1200 mm	E 90, EI 45
Electrical cables up to 80 mm $\varnothing$ (single, bundled and on trays)		E 90, EI 30
Cables up to 21mm $\varnothing$ in tied bundles up to 100mm $\varnothing$		EI 45
Steel cable trays & ladders		EI 45
Non-sheathed wires up to 17 mm $\varnothing$		E 45, EI 30
Non-sheathed wires up to 24 mm $\varnothing$		E 45, EI 20
Plastic conduits up to 16 mm $\varnothing$		EI 45 C/U, EI 45 C/C
Steel or copper conduit up to 16 mm $\varnothing$		E 45 C/U, EI 15 C/U

### A.2.3 Pipe penetration seal with 2x FPMF Board 2-S

**Penetration Seal:** 1000 mm (min.) LI (Local Interrupted) or CI (Continuous Interrupted) insulated metallic pipes (single) fitted at any position within the aperture, with 2 layers of 60 mm FPMF Board 2-S together within the floor.

Construction details:

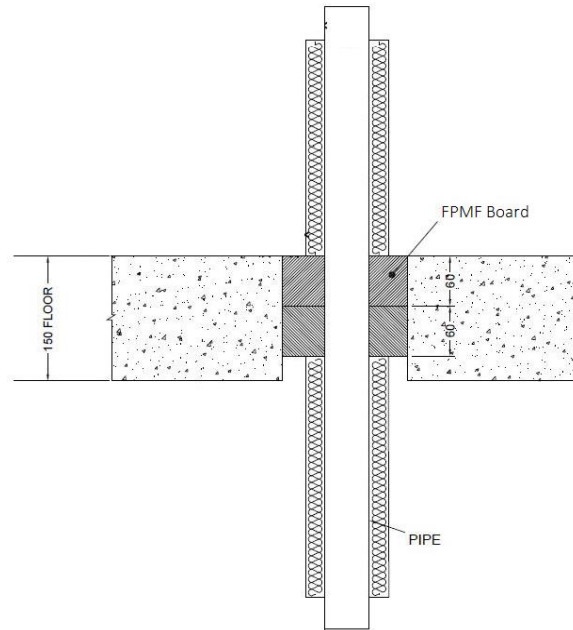

#### A.2.3.1 Two layer penetration seal with pipes

Services	Maximum aperture	Insulation, minimum thickness and density	Classification
Mild or stainless steel pipe			
40 mm diameter/1.5-14.2 mm wall*	1200 x 600 mm	20 mm Stone wool insulation 80 kg/m <sup>3</sup>	EI 180 C/U
40 mm diameter/1.5-14.2 mm wall*	280 x 280 mm		EI 240 C/U
40 mm diameter/1.5-14.2 mm wall*	2400 x 1200 mm		30 mm Stone wool insulation 80 kg/m <sup>3</sup>
40 mm diameter/1.5-14.2 mm wall*		E 180 C/U, EI 60 C/U	
50 mm diameter/1.7-14.2 mm wall*			
60 mm diameter/1.8-14.2 mm wall*			
75 mm diameter/2.1-14.2 mm wall*			
90 mm diameter/2.3-14.2 mm wall*			
100 mm diameter/2.5-14.2 mm wall*			
115 mm diameter/2.8-14.2 mm wall*			
140 mm diameter/3.2-14.2 mm wall*			
165 mm diameter/ 3.6-14.2 mm wall*			
180 mm diameter/ 3.9-14.2 mm wall*			
200 mm diameter/ 4.2-14.2 mm wall*			
219 mm diameter/ 4.5-14.2 mm wall*			

\* Typical pipe diameters shown, see below graph for intermediate sizes

Pipe diameter vs Wall thickness

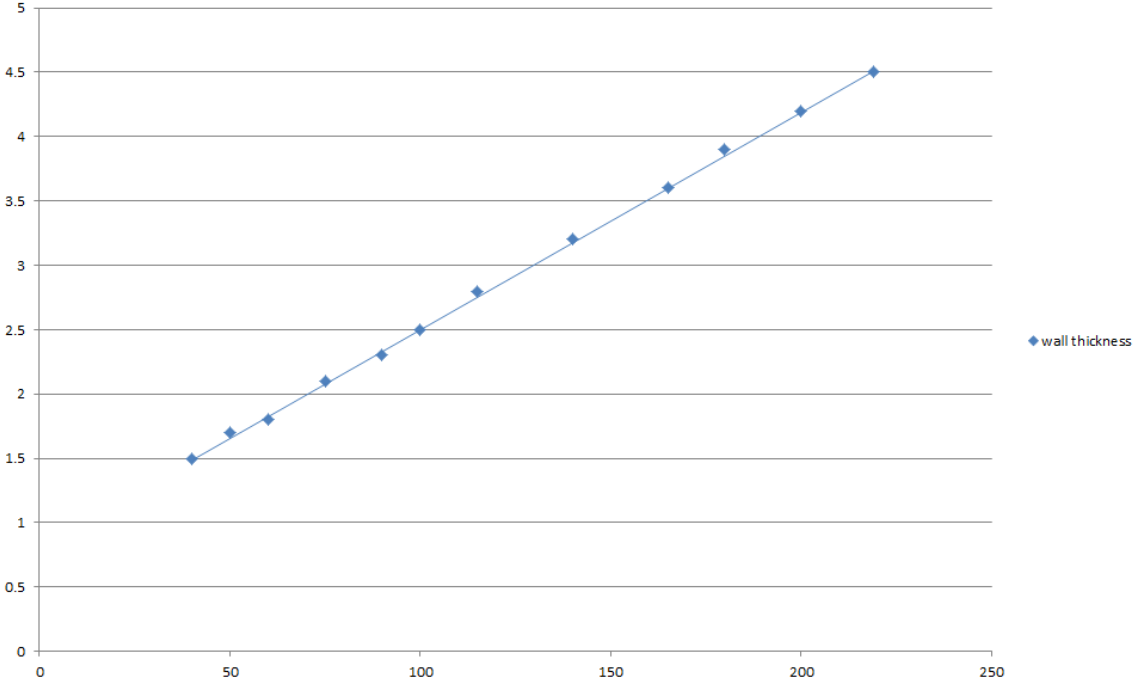



### A.2.4 Pipe penetration seal with 1x FPMF Board 2-S

**Penetration Seal:** 1000 mm (min.)\* LI (Local Interrupted) or CI (Continuous Interrupted) insulated metallic pipes (single) fitted at any position within the aperture, with 60 mm FPMF Board 2-S to either side of the floor (or anywhere in between).

Construction details:

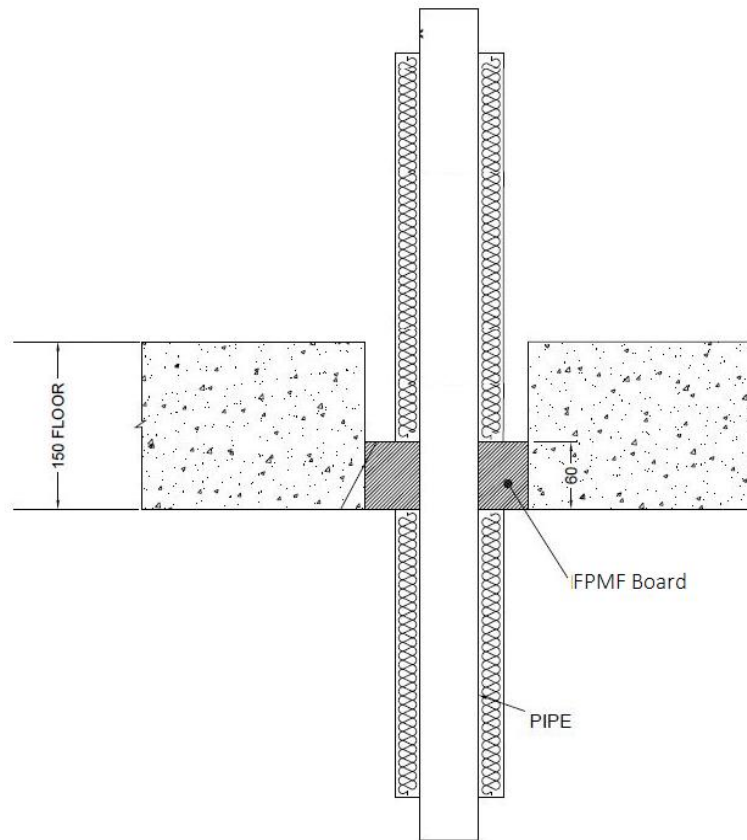

#### A.2.4.1 Single side penetration seal with pipes

Services	Maximum Aperture	Insulation, minimum thickness and density	Classification
Up to 12 mm diameter Copper pipe 0.9-14.2 mm wall	1200 x 600 mm	20 mm Stone wool insulation 80 kg/m <sup>3</sup>	E 240 C/U, EI 45 C/U
Up to 54 mm diameter Copper pipe 0.9-14.2 mm wall	1200 x 600 mm		E 240 C/U
	2400 mm x 1200 mm	E 120 C/U	
114 mm diameter mild or stainless steel pipe 11-14.2 mm wall	600 x 1200 mm	None	E 240 C/C, EI 20 C/C
	2400 mm x 1200 mm		E 120 C/C, EI 20 C/C

Services	Maximum Aperture	Insulation, minimum thickness and density	Classification
Mild or stainless steel pipe			
40 mm diameter/1.5-14.2 mm wall*	600 x 1200 mm	20 mm Stone wool insulation 80 kg/m <sup>3</sup>	<b>E 240 C/U, EI 60 C/U</b>
40 mm diameter/1.5-14.2 mm wall*		30 mm Stone wool insulation 80 kg/m <sup>3</sup>	<b>E 240 C/U, EI 90 C/U</b>
50 mm diameter/1.7-14.2 mm wall*			
60 mm diameter/1.8-14.2 mm wall*			
75 mm diameter/2.1-14.2 mm wall*			
90 mm diameter/2.3-14.2 mm wall*			
100 mm diameter/2.5-14.2 mm wall*			
115 mm diameter/2.8-14.2 mm wall*			
140 mm diameter/3.2-14.2 mm wall*			
165 mm diameter/ 3.6-14.2 mm wall*			
180 mm diameter/ 3.9-14.2 mm wall*			
200 mm diameter/ 4.2-14.2 mm wall*			
219 mm diameter/ 4.5-14.2 mm wall*			
40 mm diameter/1.5-14.2 mm wall*	2400 mm wide by 1200 mm high	20 mm Stone wool insulation 80 kg/m <sup>3</sup>	<b>E 120 C/U, EI 60 C/U</b>
40 mm diameter/1.5-14.2 mm wall*		30 mm Stone wool insulation 80 kg/m <sup>3</sup>	<b>E 120 C/U, EI 90 C/U</b>
50 mm diameter/1.7-14.2 mm wall*			
60 mm diameter/1.8-14.2 mm wall*			
75 mm diameter/2.1-14.2 mm wall*			
90 mm diameter/2.3-14.2 mm wall*			
100 mm diameter/2.5-14.2 mm wall*			
115 mm diameter/2.8-14.2 mm wall*			
140 mm diameter/3.2-14.2 mm wall*			
165 mm diameter/ 3.6-14.2 mm wall*			
180 mm diameter/ 3.9-14.2 mm wall*			
200 mm diameter/ 4.2-14.2 mm wall*			
219 mm diameter/ 4.5-14.2 mm wall*			

\* Typical pipe diameters shown, see below graph for intermediate sizes

Pipe diameter vs Wall thickness

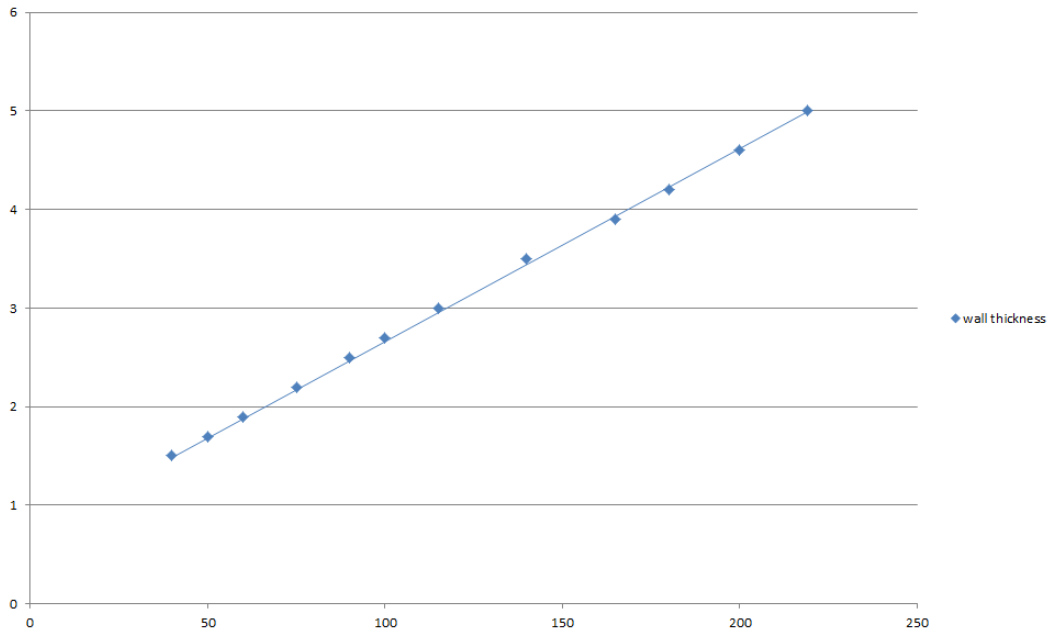

Services	Maximum Aperture	Insulation (minimum)	Classification		
Geberit Mepla MLC (PE-Xb/Aluminium/PE-HD pipe)					
16 mm diameter/2.25 mm wall	75 x 75 mm	500 mm long, 20 mm Stone wool insulation 80 kg/m <sup>3</sup>	<b>E 240 C/C, EI 180 C/C</b>		
16 mm diameter/2.25 mm wall	600 x 1200 mm		500 mm long, 20 mm Stone wool insulation 80 kg/m <sup>3</sup>	<b>E 240 C/C, EI 90 C/C</b>	
20 mm diameter/2.5 mm wall					
26 mm diameter/3 mm wall					
32 mm diameter/3 mm wall					
40 mm diameter/3.5 mm wall					
50 mm diameter/4 mm wall					
63 mm diameter/4.5 mm wall					
75 mm diameter/4.7 mm wall					
16 mm diameter/2.25 mm wall	2400 mm x 1200 mm			500 mm long, 20 mm Stone wool insulation 80 kg/m <sup>3</sup>	<b>E 120 C/C, EI 90 C/C</b>
20 mm diameter/2.5 mm wall					
26 mm diameter/3 mm wall					
32 mm diameter/3 mm wall					
40 mm diameter/3.5 mm wall					
50 mm diameter/4 mm wall					
63 mm diameter/4.5 mm wall					
75 mm diameter/4.7 mm wall					

### A.2.5 Pipe penetration seal with 1x FPMF Board 2-S

**Penetration Seal:** Combustible pipes fitted at any position within the aperture, with 50 mm FPMF Board 2-S at mid-depth of the floor. FP Pipe Wraps are required to be fitted around combustible pipe insulation. Maximum aperture size 2400 mm x 1200 mm

Construction details:

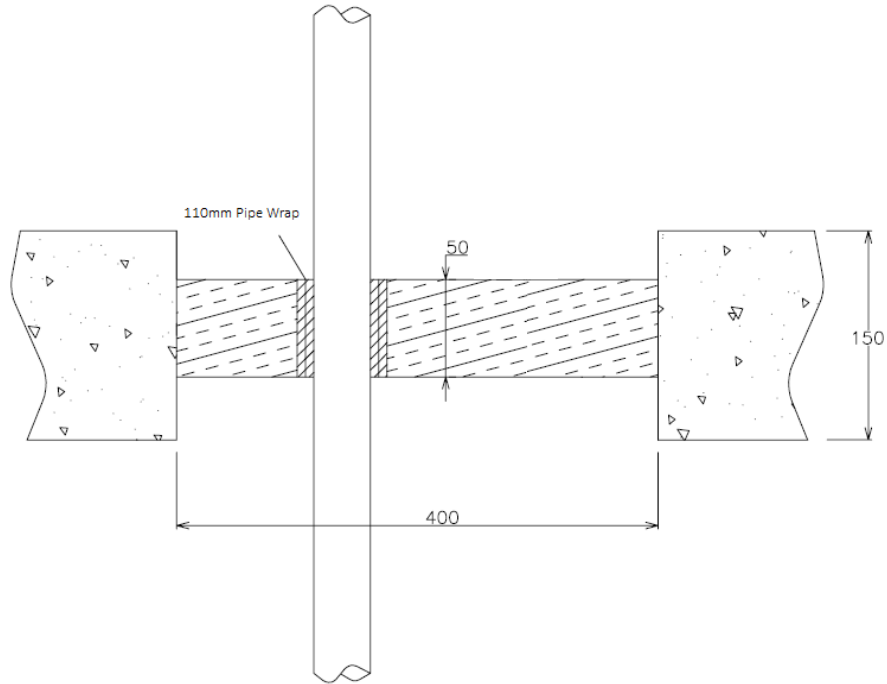

#### A.2.5.1 Central penetration seal with pipes

Services	Wrap	Classification
PVC-U pipe according to EN 1329-1, EN 1452-1 and EN 1453-1* 110 mm diameter/ 3.4mm wall	50 x 3.6 mm FP Pipe Wrap	EI 90 U/C, EI 90 C/C

**A.2.6 Pipe penetration seal with 1x FPMF Board 2-S**

**Penetration Seal:** CS (Continuous Sustained) insulated metallic pipes fitted at any position within the aperture, with 60 mm FPMF Board 2-S to either side of the floor (or anywhere in between). FP Pipe Wraps are required to be fitted around combustible pipe insulation. Maximum aperture size 2400 mm x 1200 mm

Construction details:

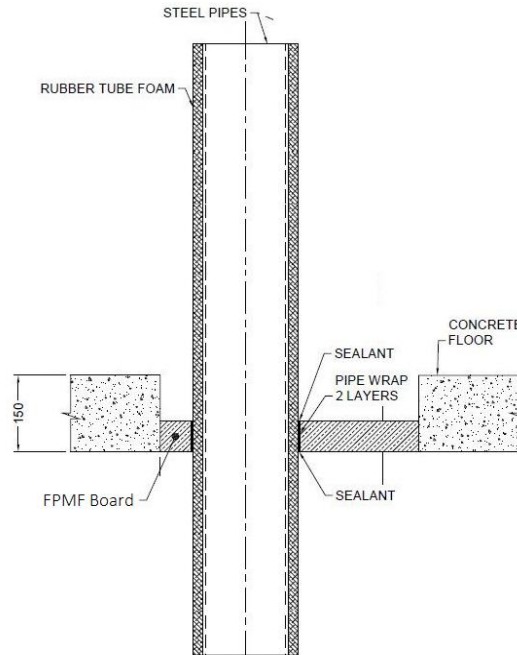

**A.2.6.1 Single side penetration seal with pipes**

Services	Wrap	Insulation	Classification
Mild or stainless steel pipe	50 x 3.6 mm FP Pipe Wrap fitted at bottom of seal	13 mm elastomeric insulation min. class B-s3, d0	<b>E 90 C/U, EI 45 C/U</b>
165 mm diameter/ 4.5-14.2 mm wall		19 mm elastomeric insulation min. class B-s3, d0	<b>EI 90 C/U</b>
	Not required	25-40 mm stone wool min. 80 kg/m <sup>3</sup>	<b>E 90 C/U, EI 60 C/U</b>

### A.2.7 Pipe penetration seal with 2x FPMF Board 2-S

**Penetration Seal:** CS (Continuous Sustained) insulated metallic pipes fitted at any position within the aperture, with 60 mm FPMF Board 2-S to both sides of the floor. FP Pipe Wraps are required to be fitted around combustible pipe insulation at the soffit. Maximum aperture size 2400 mm x 1200 mm

Construction details:

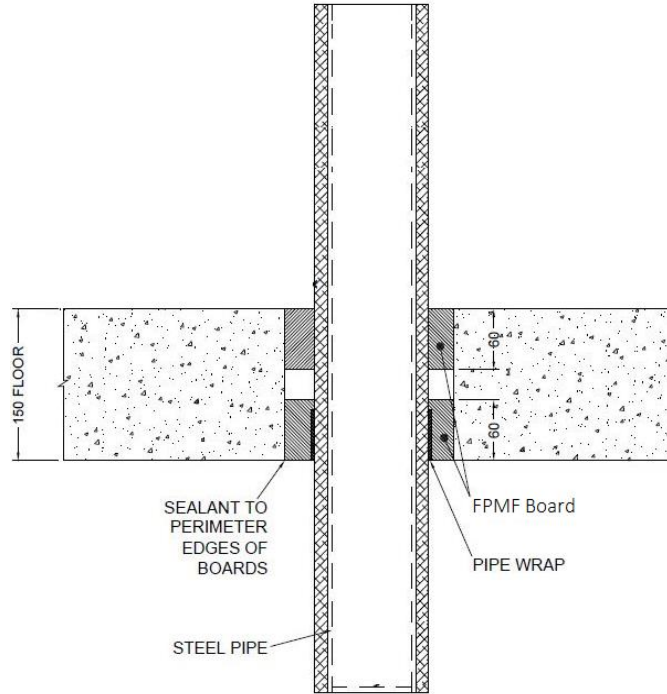

#### A.2.7.1 Double side penetration seal with pipes

Services	Wrap	Insulation	Classification
Mild or stainless steel pipe			
Up to 40 mm diameter/ 1-14.2 mm wall	50 x 1.8 mm FP Pipe Wrap	13 mm elastomeric insulation min. class B-s3, d0	<b>E 180 C/U, EI 120 C/U</b>

### A.2.8 Pipe penetration seal with 2x FPMF Board 2-S (back to back)

**Penetration Seal:** CS (Continuous Sustained) insulated metallic and composite pipes fitted at any position within the aperture, with two layers of 60 mm FPMF Board 1-S installed together to either side of the floor (or anywhere in between). FP Pipe Wraps are required to be fitted around combustible pipe insulation at the bottom of the seal. Maximum aperture size 2400 mm x 1200 mm

Construction details:

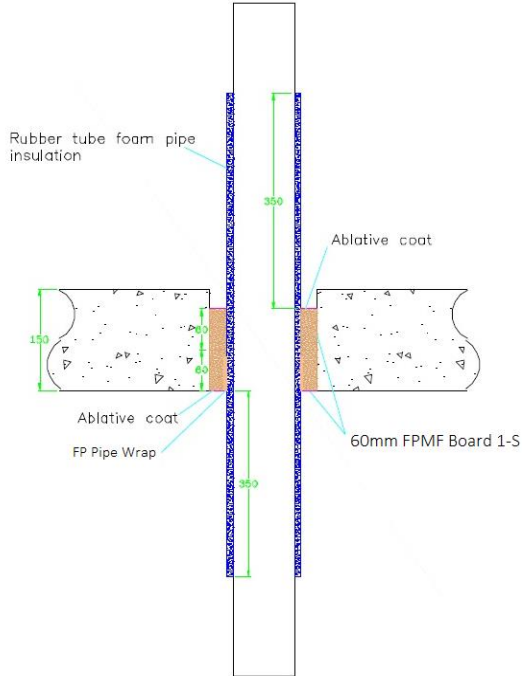

**A.2.8.1 Back to back penetration seal with pipes**

Services	Wrap	Insulation	Classification
Copper pipe	50 x 3.6 mm FP Pipe Wrap fitted to both sides of the seal	9-13 mm elastomeric insulation min. class B-s3, d0	<b>E240 C/C, EI 60 C/C</b>
12-54 mm diameter/1-1.2 mm wall		13-25 mm elastomeric insulation min. class B-s3, d0	<b>E 180 C/C, EI 45 C/C</b>
<b>Geberit Mepla MLC (PE-Xb/Aluminium/PE-HD pipe)</b>			
16 mm diameter/2.25 mm wall	50 x 3.6 mm FP Pipe Wrap fitted to both sides of the seal	9 mm elastomeric insulation min. class B-s3, d0	<b>EI 120 C/C</b>
20 mm diameter/2.5 mm wall			
26 mm diameter/3 mm wall			
32 mm diameter/3 mm wall			
40 mm diameter/3.5 mm wall			
50 mm diameter/4 mm wall			
63 mm diameter/4.5 mm wall			
75 mm diameter/4.7 mm wall			
16 mm diameter/2.25 mm wall		13-25 mm elastomeric insulation min. class B-s3, d0	<b>E 60 C/C, EI 45 C/C</b>
20 mm diameter/2.5 mm wall			
26 mm diameter/3 mm wall			
32 mm diameter/3 mm wall			
40 mm diameter/3.5 mm wall			
50 mm diameter/4 mm wall			
63 mm diameter/4.5 mm wall			
75 mm diameter/4.7 mm wall			



### A.3 Timber floor constructions according to 2. 2) with floor thickness of minimum 150 mm

#### A.3.1 Cable penetration seal with 2x FPMF Board 1-S

**Penetration Seal:** Cables fitted at any position within the aperture, with 2 layers of 50 mm FPMF Board 1-S within the floor with the coated sides downwards. The external board layer has a minimum 100 mm overlap all around the aperture.

Construction details:

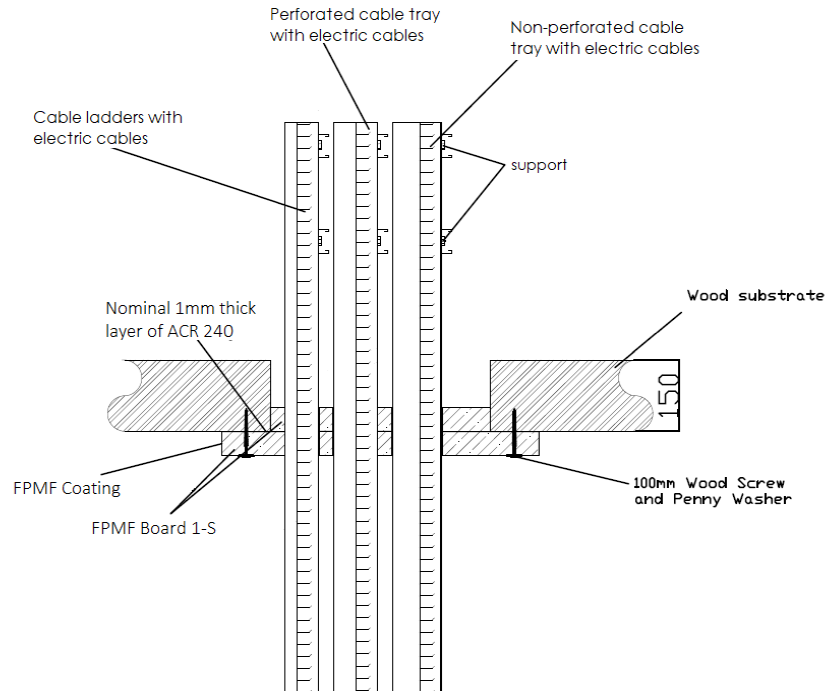

#### A.3.1.1 Back to back penetration seal with cables

Services	Maximum aperture	Classification
Electrical cables up to 21 mm $\varnothing$ (single, bundled and on trays)	1200 mm x 600 mm	E 90, EI 45
Electrical cables up to 50 mm $\varnothing$ (single, bundled and on trays)		E 90, EI 60
Electrical cables up to 80 mm $\varnothing$ (single, bundled and on trays)		E 90, EI 60
Cables up to 21mm $\varnothing$ in tied bundles up to 100mm $\varnothing$		E 90, EI 60
Steel cable trays & ladders		E 90, EI 60
Non-sheathed wires up to 24 mm $\varnothing$		E 90, EI 30
PE-X pipe-in-pipe up to 25 mm diameter / 1.0 mm wall		EI 90 C/C

### A.3.2 Pipe penetration seal with 2x FPMF Board 1-S

**Penetration Seal:** 500 mm (min.)\* LI (Local Interrupted) or CI (Continuous Interrupted) insulated metallic pipes fitted at any position within the aperture, with 2 layers of 50 mm FPMF Board 1-S within the floor with the coated sides downwards. The external board layer has a minimum 100 mm overlap all around the aperture.

Construction details:

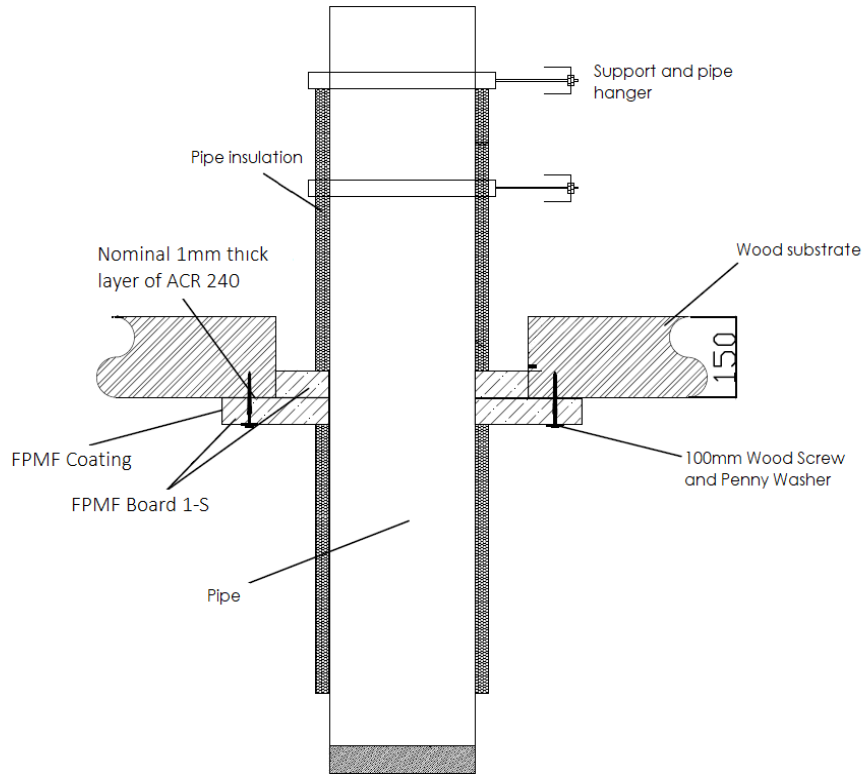

#### A.3.2.1 Back to back penetration seal with pipes

Services	Max. aperture	Insulation, minimum thickness and density	Classification
Mild or stainless steel pipe	1200 mm x 600 mm	20 mm glass or stone wool insulation 75 kg/m <sup>3</sup>	E 90 C/U, EI 60 C/U
60 mm diameter*			
273 mm diameter*			
Copper or steel pipes			
15 mm diameter*	1200 mm x 600 mm	20 mm glass or stone wool insulation 75 kg/m <sup>3</sup>	EI 90 C/C
54 mm diameter*			EI 90 C/C
Alupex pipes			
16 mm diameter*	1200 mm x 600 mm	20 mm glass or stone wool insulation 75 kg/m <sup>3</sup>	E 90 C/C, EI 60 C/C
75 mm diameter*			

\*See below graphs for interpolation pipe sizes

### Mild or Stainless Steel Pipes - E 90 C/U, EI 60 C/U

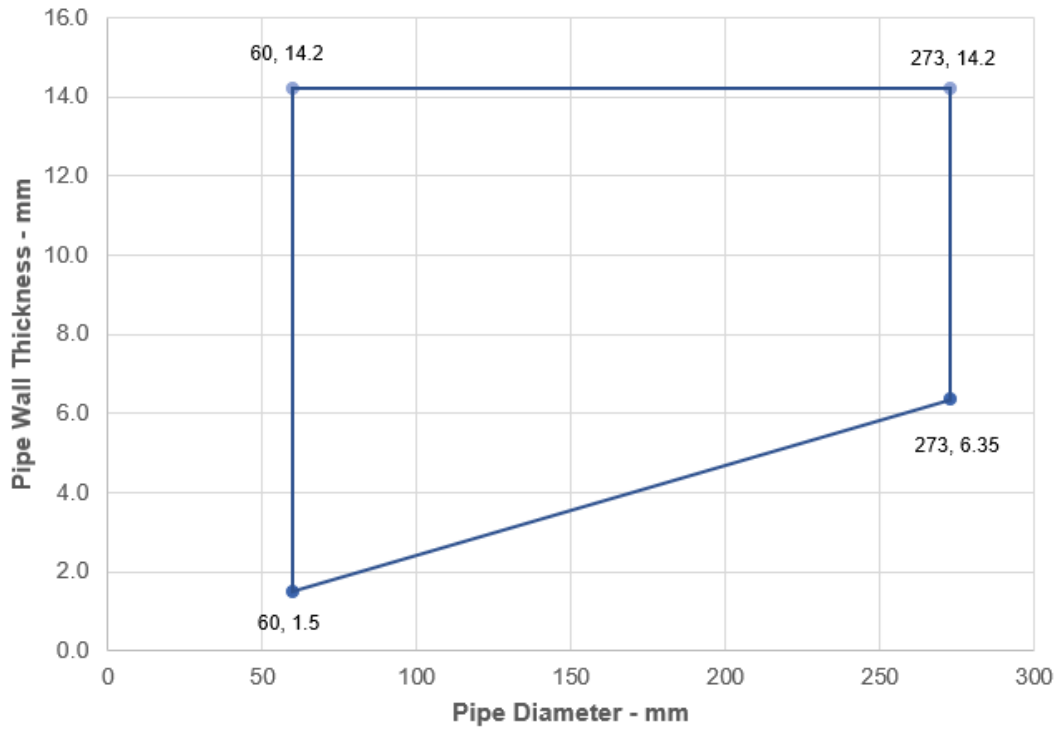

### Copper or Steel Pipes- EI 90 C/C

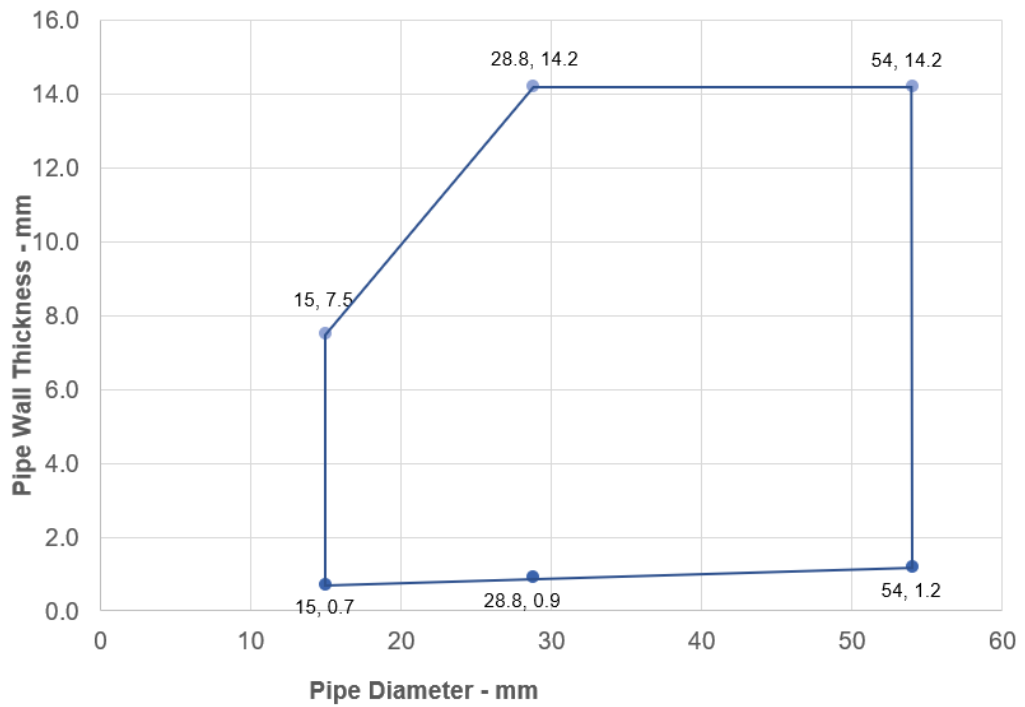

### ALUPEX Pipes - E 90 C/C, EI 60 C/C

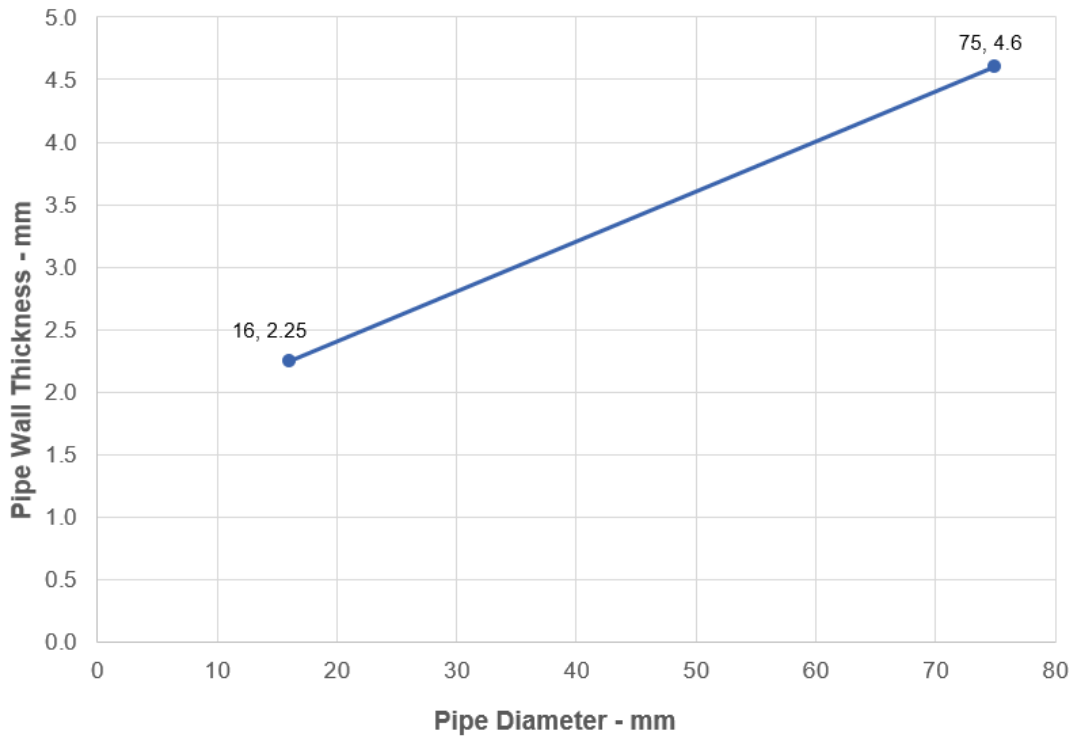

**A.4 Flexible or rigid wall constructions according to 2. 2) with wall thickness of minimum 75 mm**

**A.4.1 Cable penetration seal with 2x FPMF Board 30 1-S**

**Penetration Seal:** Cables fitted at any position within the aperture, with 30 mm FPMF Board 1-S to both sides of the wall. Minimum 30 mm separation between pipes

Construction details:

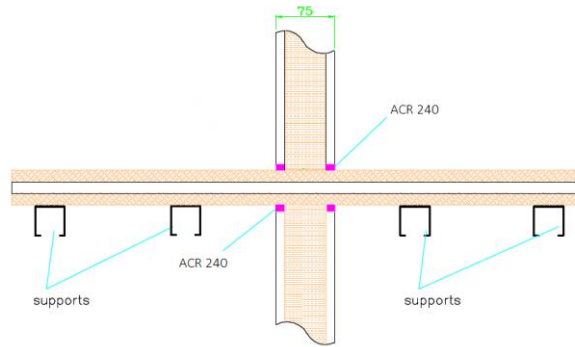
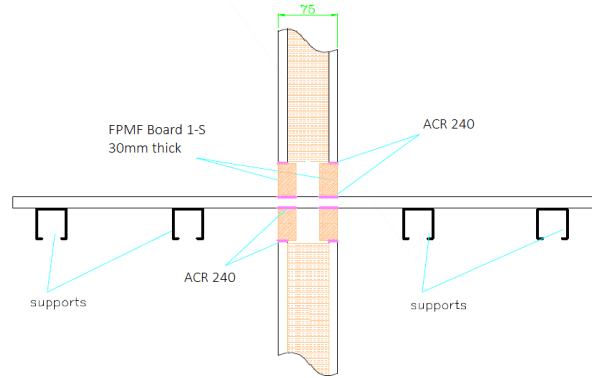
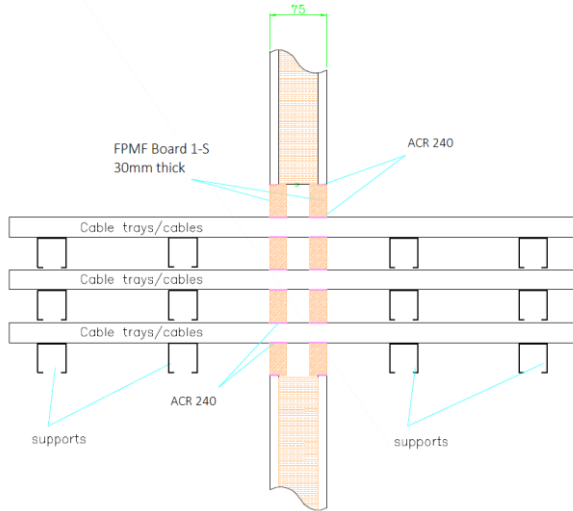

**A.4.1.1 Double side penetration seal with cables**

Services	Maximum aperture	Classification
Electrical cables up to 21 mm $\varnothing$ (single, bundled and on trays)	1200 mm wide x 600 mm high	EI 45
Electrical cables up to 80 mm $\varnothing$ (single, bundled and on trays)		E 45, EI 30
Cables including telecoms up to 21mm $\varnothing$ in tied bundles up to 100mm $\varnothing$		
Steel cable trays & ladders		E 45, EI 20
Unsheathed wires up to 24 mm $\varnothing$		EI 45
Plastic conduits maximum 32 mm diameter		

Services	Maximum Aperture	Insulation, minimum thickness and density - CS	Classification
Mild or stainless steel pipe	1200 mm wide x 600 mm high	None	EI 45 C/U
4 mm diameter/0.7-14.2 mm wall			E 45 C/U, EI 30 C/U
22 mm diameter/2.0-14.2 mm wall			EI 45 C/U
40 mm diameter/1.0-14.2 mm wall*		30 mm Stone wool insulation 80 kg/m <sup>3</sup>	EI 45 C/U
40 mm diameter/1.0-14.2 mm wall*			
50 mm diameter/1.7-14.2 mm wall*			
60 mm diameter/1.8-14.2 mm wall*			
75 mm diameter/2.1-14.2 mm wall*			
90 mm diameter/2.3-14.2 mm wall*			
100 mm diameter/2.5-14.2 mm wall*			
115 mm diameter/2.8-14.2 mm wall*			
140 mm diameter/3.2-14.2 mm wall*			
165 mm diameter/ 3.6-14.2 mm wall*			
180 mm diameter/ 3.9-14.2 mm wall*			
200 mm diameter/ 4.2-14.2 mm wall*			
219 mm diameter/ 4.5-14.2 mm wall*			
250 mm diameter/ 5.0-14.2 mm wall*			
300 mm diameter/ 5.9-14.2 mm wall*			
324 mm diameter/ 6.35-14.2 mm wall*			

\* Typical pipe diameters shown, see below graph for intermediate sizes

CS – Continuous Sustained

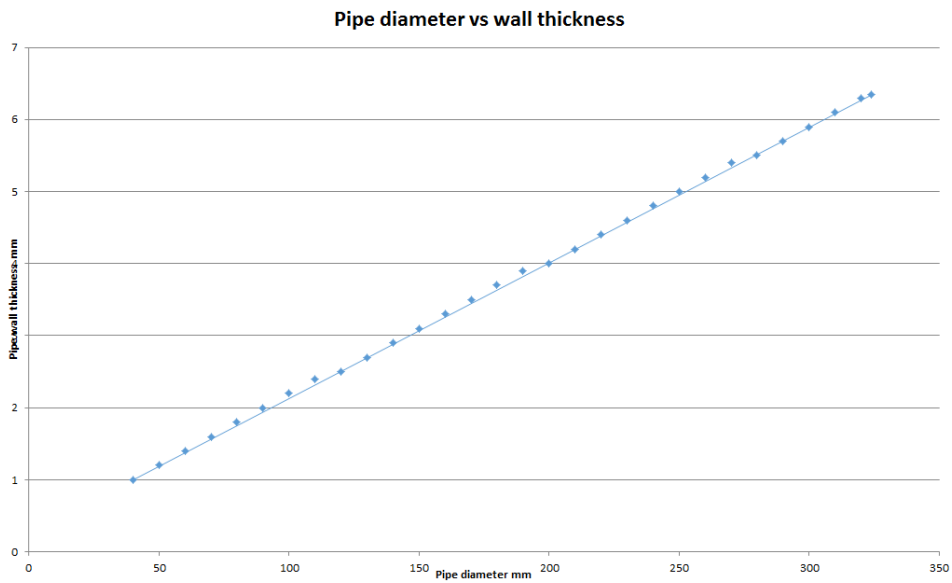

### A.4.2 Cable penetration seal with 2x FPMF Board 1-S

**Penetration Seal:** Cables fitted at any position within the aperture, with 50 mm FPMF Board 1-S to both sides of the wall.

Construction details:

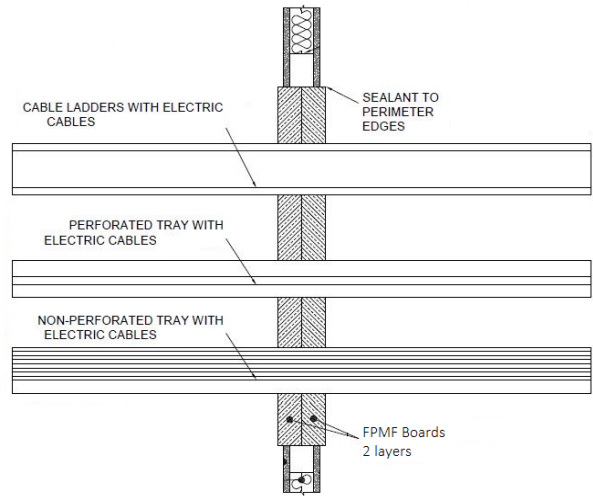
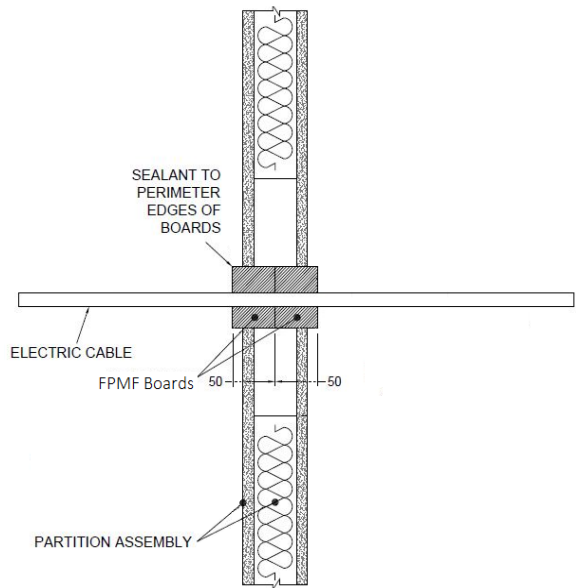

#### A.4.2.1 Double side penetration seal with cables

Services	Maximum aperture	Classification
None (blank)	As section 2.5)	EI 60
Single electrical cables up to 21 mm $\varnothing$		EI 60
Electrical cables up to 80 mm $\varnothing$ (single, bundled and on trays)		E 60, EI 45
Cables up to 21mm $\varnothing$ in tied bundles up to 100mm $\varnothing$		EI 60
Steel cable trays & ladders		EI 60 C/U
Steel conduit up to 16 mm $\varnothing$		E 60 C/U, EI 45 C/U
Copper conduit up to 16 mm $\varnothing$		E 60, EI 30
Unsheathed wires up to 24 mm $\varnothing$		EI 60 C/U, EI 60 C/C
Plastic conduits up to 16 mm $\varnothing$		

**A.5 Flexible or rigid wall constructions according to 2. 2) with wall thickness of minimum 100 mm**

**A.5.1 Cable penetration seal with 2x FPMF Board 1-S**

**Penetration Seal:** Cables fitted at any position within the aperture, with 50 mm FPMF Board 1-S to both sides of the wall.

Construction details:

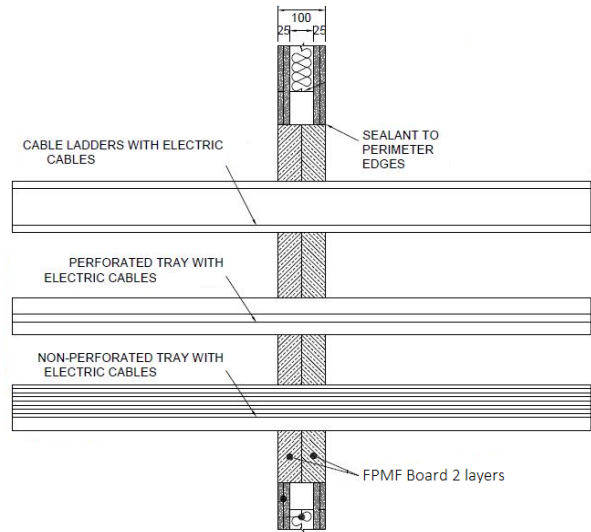
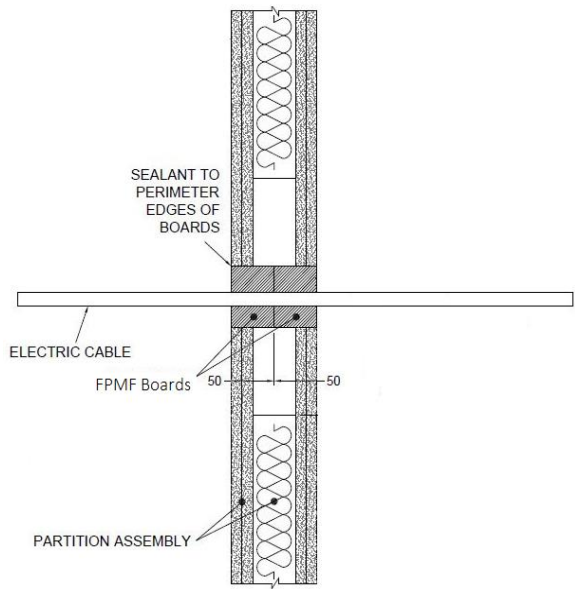

**A.5.1.1 Double side penetration seal with cables**

Services	Maximum aperture	Classification
None (blank)	As section 2. 5)	EI 120
Single electrical cables up to 21 mm $\varnothing$		E 120, EI 60
Electrical cables up to 80 mm $\varnothing$ (single, bundled and on trays)		EI 60
Cables up to 21mm $\varnothing$ in tied bundles up to 100mm $\varnothing$		
Steel cable trays & ladders		EI 60 C/U
Steel conduit up to 16 mm $\varnothing$		E 60 C/U, EI 45 C/U
Copper conduit up to 16 mm $\varnothing$		E 60, EI 30
Unsheathed wires up to 24 mm $\varnothing$		EI 60 C/U, EI 60 C/C
Plastic conduits up to 16 mm $\varnothing$		



### A.5.2 Pipe penetration seal with 2x FPMF Board 1-S

**Penetration Seal:** CS (Continuous Sustained) insulated metallic pipes fitted at any position within the aperture, with 50 mm FPMF Board 1-S to both sides of the wall. Minimum separation between penetration seals and seal edges of 30 mm.

Construction details:

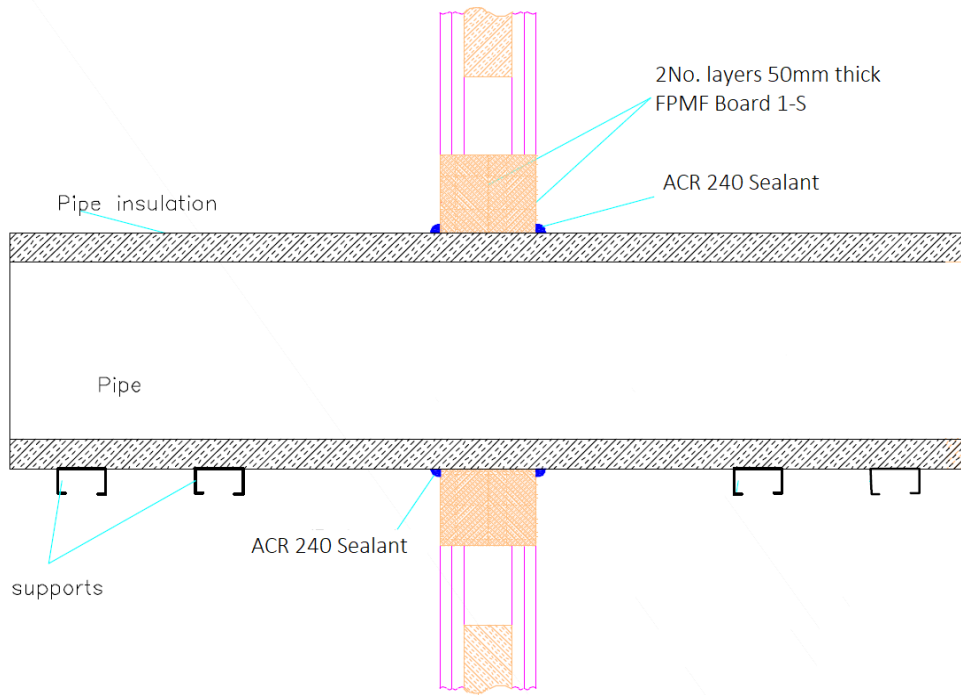

#### Configuration 1

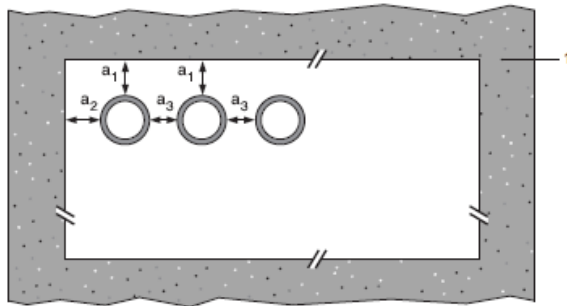

#### Configuration 2

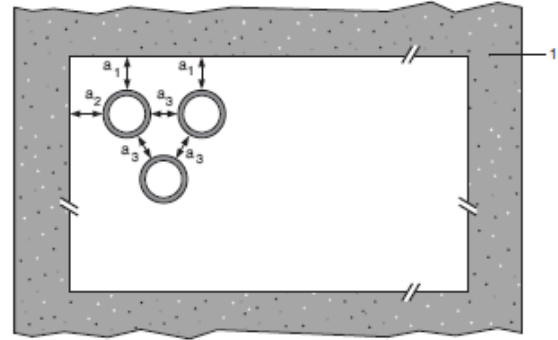

#### Key

- 1 Supporting construction
- a1 Pipe / top edge of seal separation
- a2 Pipe / side edge of seal separation
- a3 Pipe / pipe separation

**A.5.2.1 Double side penetration seal with pipes**

Services	Insulation	Classification
Mild or stainless steel pipe		
40 mm diameter/1-14.2 mm wall	20 mm thick stone, mineral wool min. 80 kg/m <sup>3</sup>	<b>EI 120 C/U</b>
40 mm diameter/1-14.2 mm wall*	30-80 mm thick stone, mineral wool min. 80 kg/m <sup>3</sup>	
50 mm diameter/1.2-14.2 mm wall*		
60 mm diameter/1.4-14.2 mm wall*		
75 mm diameter/1.6-14.2 mm wall*		
90 mm diameter/1.9-14.2 mm wall*		
100 mm diameter/2.1-14.2 mm wall*		
115 mm diameter/2.4-14.2 mm wall*		
140 mm diameter/2.9-14.2 mm wall*		
165 mm diameter/ 3.4-14.2 mm wall*		
180 mm diameter/ 3.6-14.2 mm wall*		
200 mm diameter/ 4.0-14.2 mm wall*		
219 mm diameter/ 4.3-14.2 mm wall*		
250 mm diameter/ 5.0-14.2 mm wall*		
300 mm diameter/ 5.9-14.2 mm wall*		
324 mm diameter/ 6.35-14.2 mm wall*		
PEX pipe in pipe system		
15 mm diameter x 2.5 mm wall inner /25mm diameter outer	None	<b>EI 90 C/C</b>

**Pipe Diameter vs wall thickness**

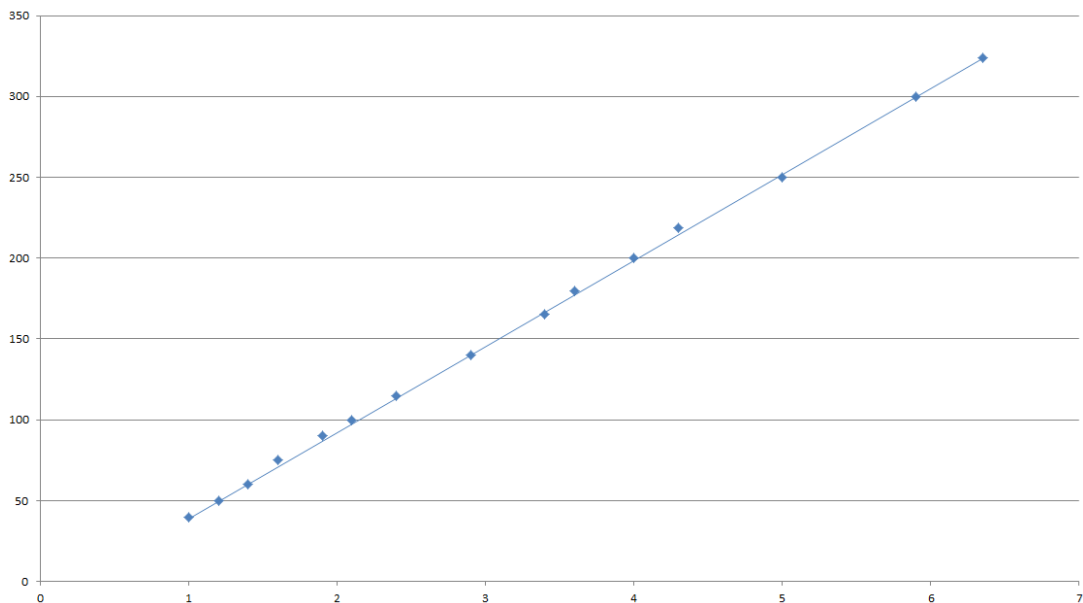

Services	Insulation	Classification
Mild or stainless steel pipe	None	EI 120 C/U
4 mm diameter*		
5-22 mm diameter*		
Copper, mild or stainless steel pipe		
Up to 6 mm diameter/0.7-14.2 mm wall	None	E 120 C/C, EI 60 C/C
Up to 15 mm diameter/0.7-7.5 mm wall	20 mm thick glass or stone wool min. 75 kg/m <sup>3</sup>	EI 60 C/C
16-54 mm diameter/0.7-14.2 mm wall*		E 60 C/C, EI 45 C/C
Up to 54 mm diameter/0.7-14.2 mm wall*	40 mm thick glass or stone wool min. 75 kg/m <sup>3</sup>	EI 60 C/C
Alupex pipe		
16 -20 mm diameter/2.0 mm wall	None	EI 120 C/C
16 mm diameter/2.0-2.25 mm wall	20 mm thick glass or stone wool min. 75 kg/m <sup>3</sup>	E 120 C/C, EI 90 C/C
16-75 mm diameter*	25-60 mm thick glass or stone wool min. 75 kg/m <sup>3</sup>	E 120 C/C, EI 90 C/C
PVC-U~ pipe		
6 mm diameter*	None	EI 120 U/C
7-32 mm diameter*		EI 60 U/C
32 mm diameter*		EI 90 U/C
PE^ pipe		
20 mm diameter/2.0 mm wall	None	E 120 U/C, EI 90 U/C
21-32 mm diameter/2.0-3.0 mm wall		EI 60 U/C
32 mm diameter/3.0 mm wall		EI 90 U/C
PP pipe		
20 mm diameter/2.2 mm wall	None	E 120 U/C, EI 60 U/C
Up to 32 mm diameter/1.8 mm wall		

\*See below graphs for interpolation pipe sizes

~ PVC-U pipe according to EN 1329-1, EN 1452-1 and EN 1453-1 and PVC-C according to EN 1566-1

^ PE pipe according to EN 1519-1, EN 12201-2 and EN 12666-1, ABS according to EN 1455-1 and pipes made from SAN+PVC according to EN 1565-1

### Mild or Stainless Steel Pipes - E 120 C/U, EI 60 C/U

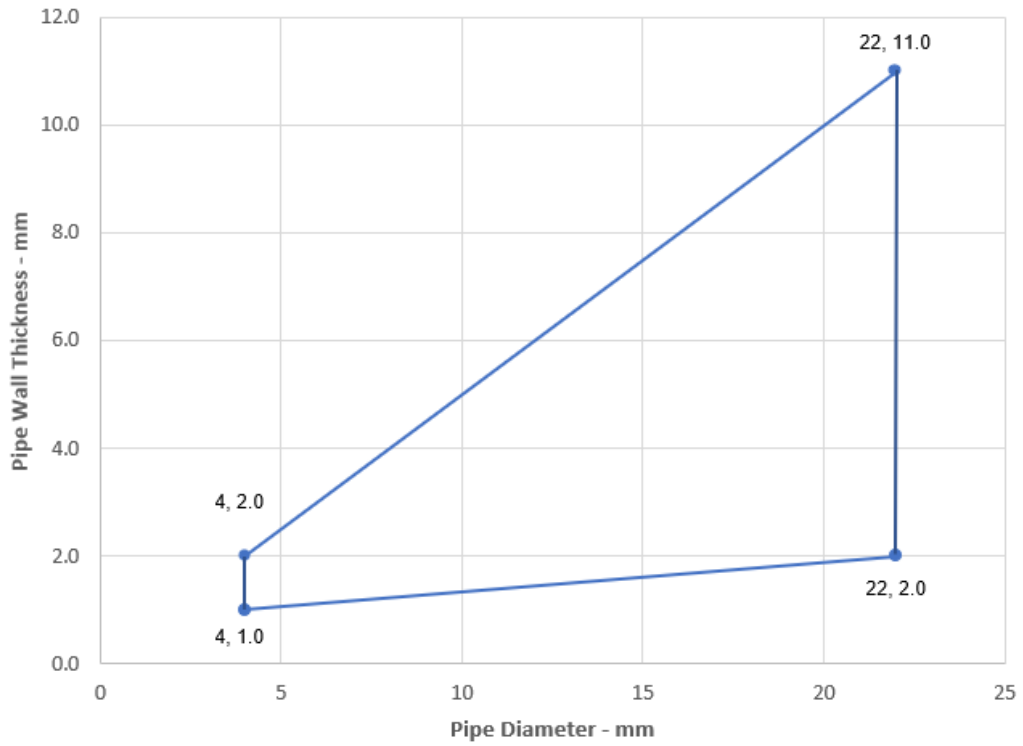

### Copper or Steel Pipes with Glass or Stone Wool Insulation - C/C

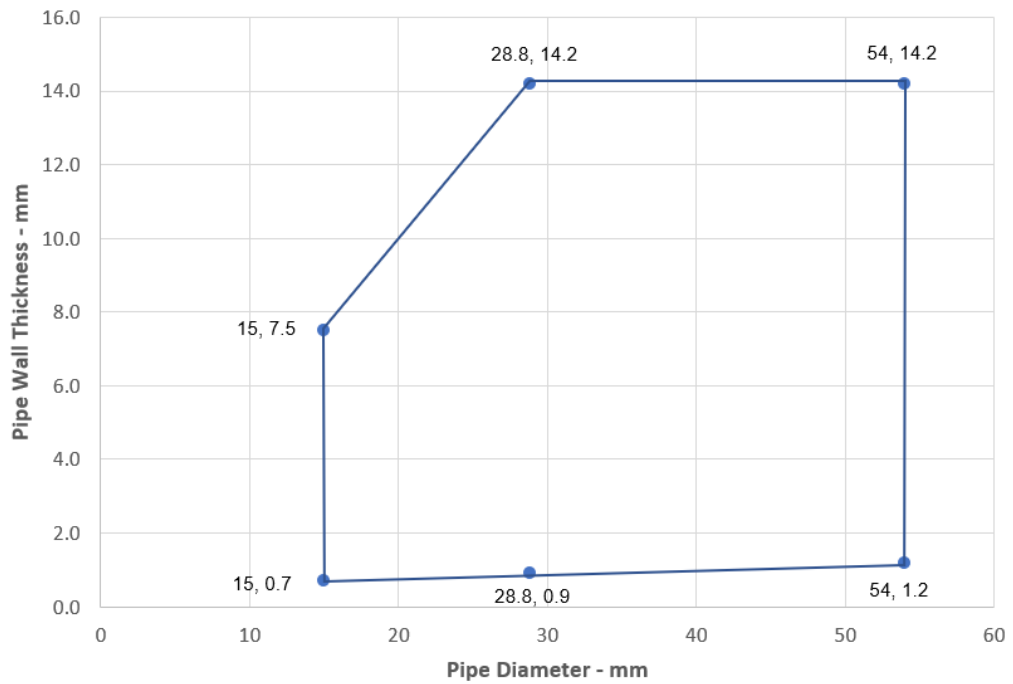

### Alupex Pipes - E 120 C/C, EI 90 C/C

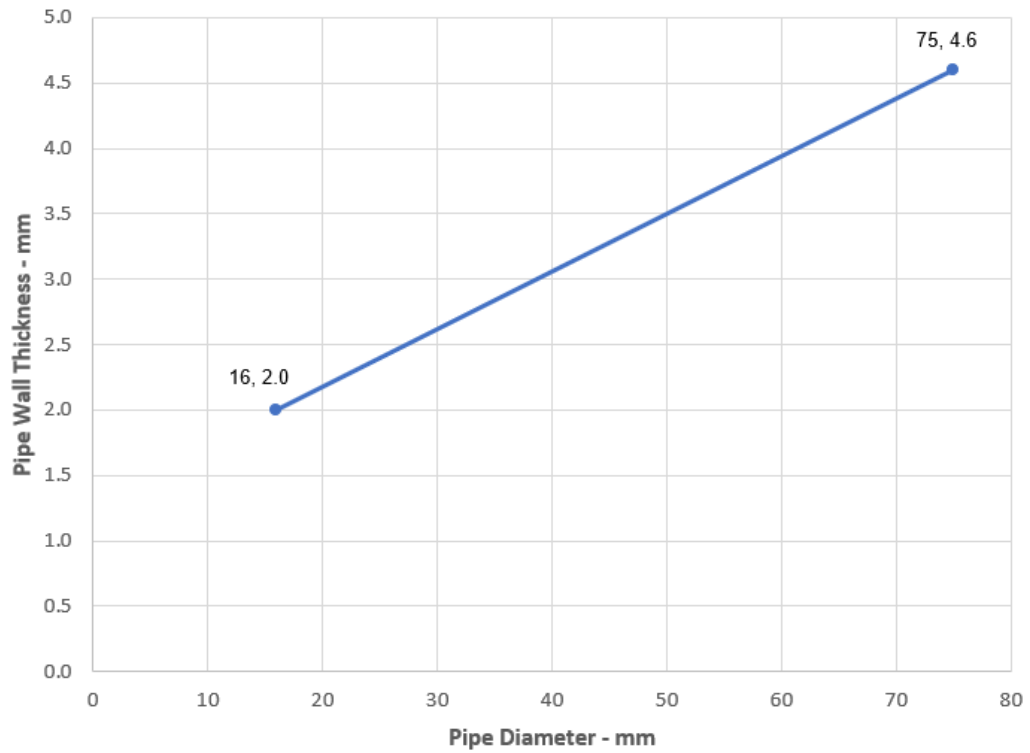

### PVC-U Pipes - EI 60 U/C

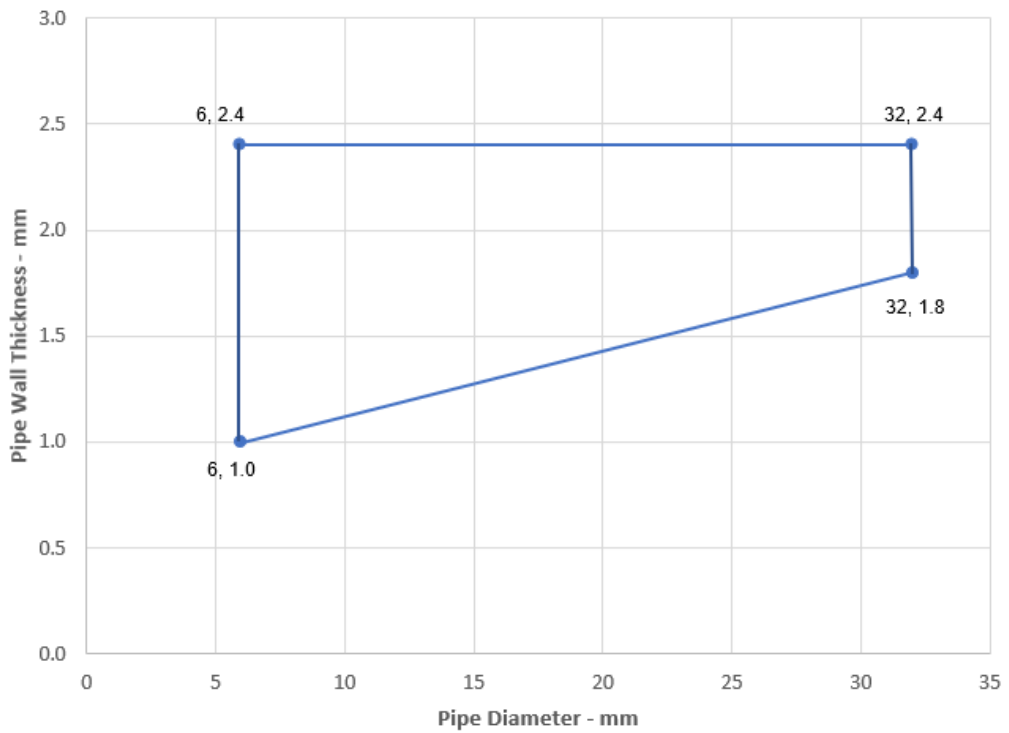

### A.5.3 Pipe penetration seal with 2x FPMF Board 1-S

**Penetration Seal:** CS (Continuous Sustained) insulated metallic pipes fitted at any position within the aperture, with 50 mm FPMF Board 1-S to both sides of the wall. Minimum separation between penetration seals and seal edges of 30 mm. FP Pipe Wraps are required to be fitted around the pipe insulation.

Construction details:

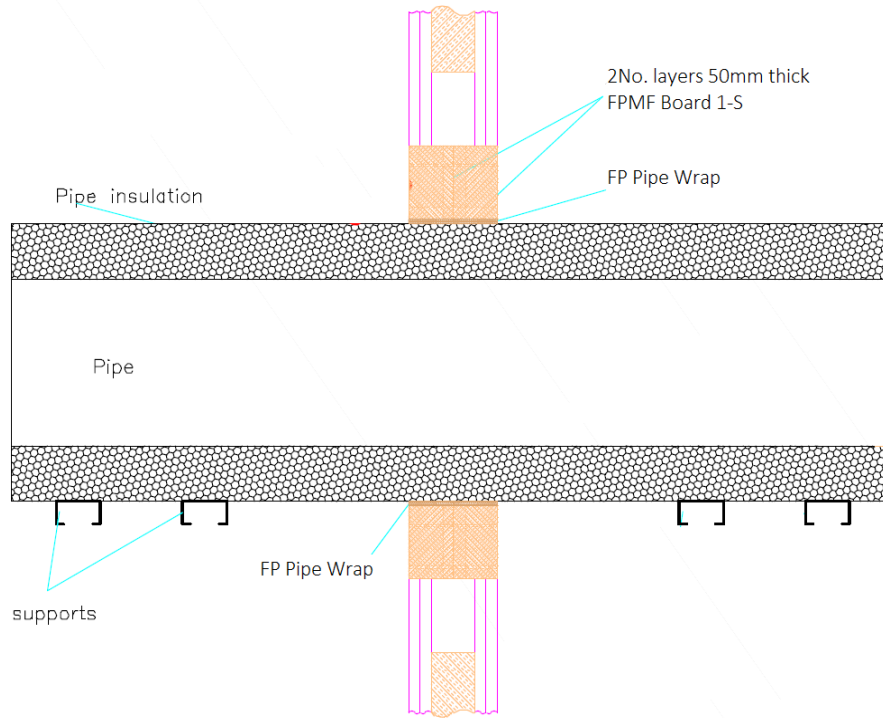

**Configuration 1**

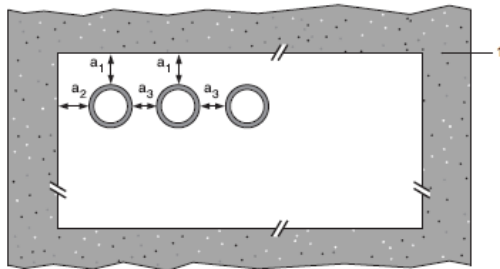

**Configuration 2**

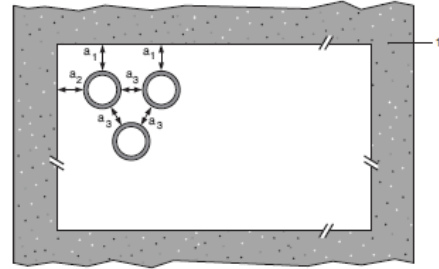

**Key**

- 1 Supporting construction
- a1 Pipe / top edge of seal separation
- a2 Pipe / side edge of seal separation
- a3 Pipe / pipe separation

**A.5.3.1 Double side penetration seal with pipes**

Services	Insulation	FP Wrap	Classification
Mild or stainless steel pipe	32-50 mm thick Elastomeric insulation minimum class B-s3, d0 or PE Foam insulation	3 layers 50 x 1.8 mm	EI 90 C/U
40 mm diameter/1-14.2 mm wall*			
50 mm diameter/1.2-14.2 mm wall*			
60 mm diameter/1.4-14.2 mm wall*			
75 mm diameter/1.6-14.2 mm wall*			
90 mm diameter/1.9-14.2 mm wall*			
100 mm diameter/2.1-14.2 mm wall*			
115 mm diameter/2.4-14.2 mm wall*			
140 mm diameter/2.9-14.2 mm wall*			
165 mm diameter/ 3.4-14.2 mm wall*			
180 mm diameter/ 3.6-14.2 mm wall*			
200 mm diameter/ 4.0-14.2 mm wall*			
219 mm diameter/ 4.3-14.2 mm wall*			
250 mm diameter/ 5.0-14.2 mm wall*			
300 mm diameter/ 5.9-14.2 mm wall*			
324 mm diameter/ 6.35-14.2 mm wall*			

**Pipe Diameter vs wall thickness**

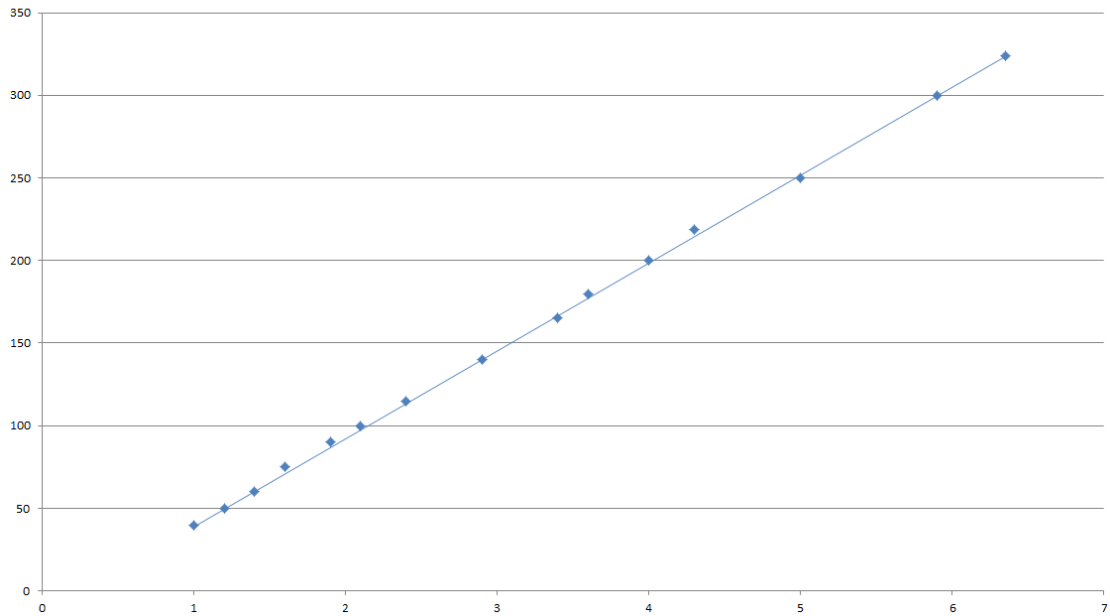

### A.5.4 Pipe penetration seal with 2x FPMF Board 1-S

**Penetration Seal:** CS (Continuous Sustained) insulated metallic pipes fitted at any position within the aperture, with 50 mm FPMF Board 1-S to both sides of the wall. FP Pipe Wraps are required to be fitted around the pipe insulation.

Construction details:

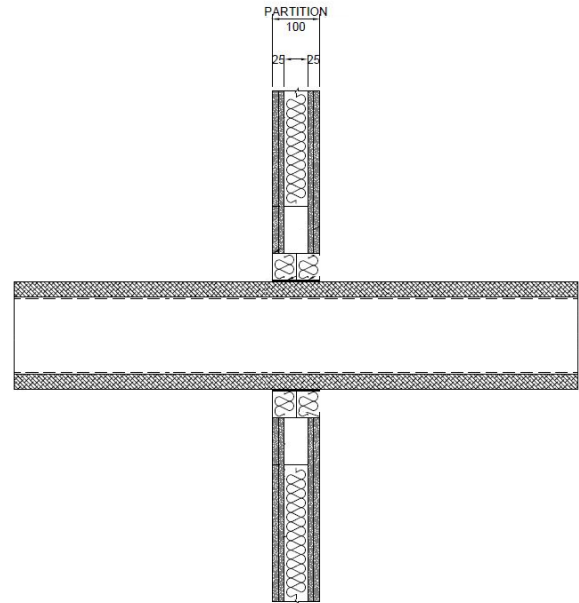
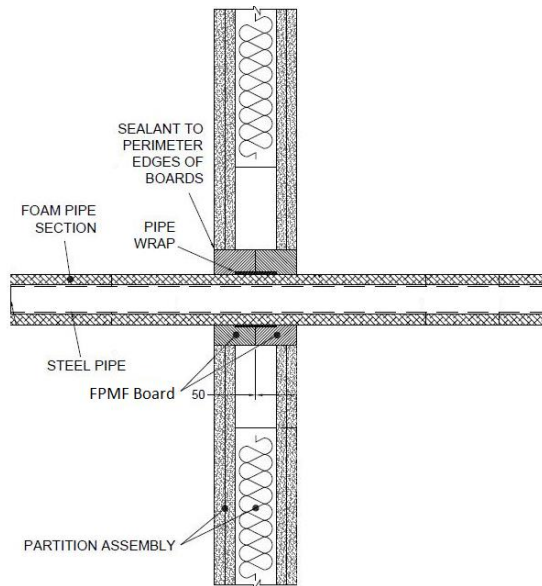

#### A.5.4.1 Two layer penetration seal with pipes

Services	Wrap	Insulation	Classification
Mild or stainless steel pipe			
Up to 40 mm diameter/1-14.2 mm wall	50 x 1.8 mm FP Pipe Wrap fitted centrally	13 mm elastomeric insulation minimum class B-s3, d0 or PE Foam insulation	<b>EI 120 U/C, EI 120 U/U, EI 120 C/U, EI 120 C/C</b>
Up to 40 mm diameter/1-14.2 mm wall*			
50 mm diameter/1.3-14.2 mm wall*			
60 mm diameter/1.6-14.2 mm wall*			
75 mm diameter/2-14.2 mm wall*			
90 mm diameter/2.4-14.2 mm wall*			
100 mm diameter/2.7-14.2 mm wall*			
115 mm diameter/3.1-14.2 mm wall*			
140 mm diameter/3.8-14.2 mm wall*			
165 mm diameter/ 4.5-14.2 mm wall*			
	2 off 50 x 3.6 mm FP Pipe Wrap, one fitted flush to each face of seal	13 – 32 mm elastomeric insulation minimum class B-s3, d0 or PE Foam insulation	<b>E 120 U/C, E 120 U/U, E 120 C/U, E 120 C/C, EI 60 U/C, EI 60 U/U, EI 60 C/U, EI 60 C/C</b>

\* Typical pipe diameters shown, see below graph for intermediate sizes



**Pipe diameter vs Wall thickness**

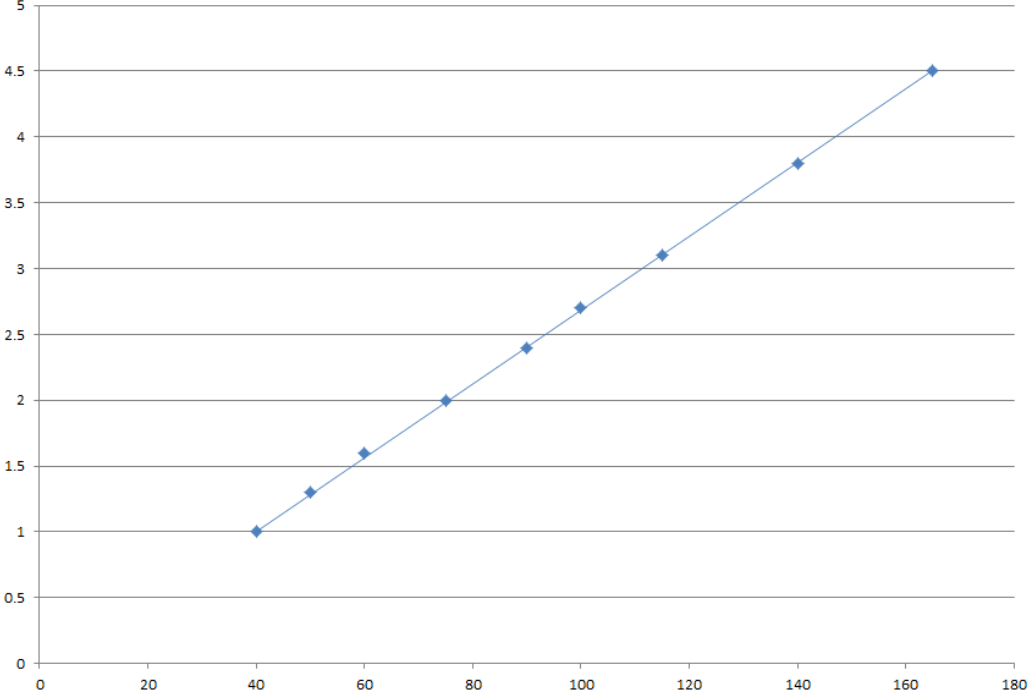

### A.5.5 Pipe penetration seal with 2x FPMF Board 1-S

**Penetration Seal:** 500 mm (min.) LI (Local Interrupted) or CI (Continuous Interrupted) insulated or uninsulated metallic and composite pipes fitted at any position within the aperture, with 50 mm FPMF Board 1-S to both sides of the wall.

Construction details:

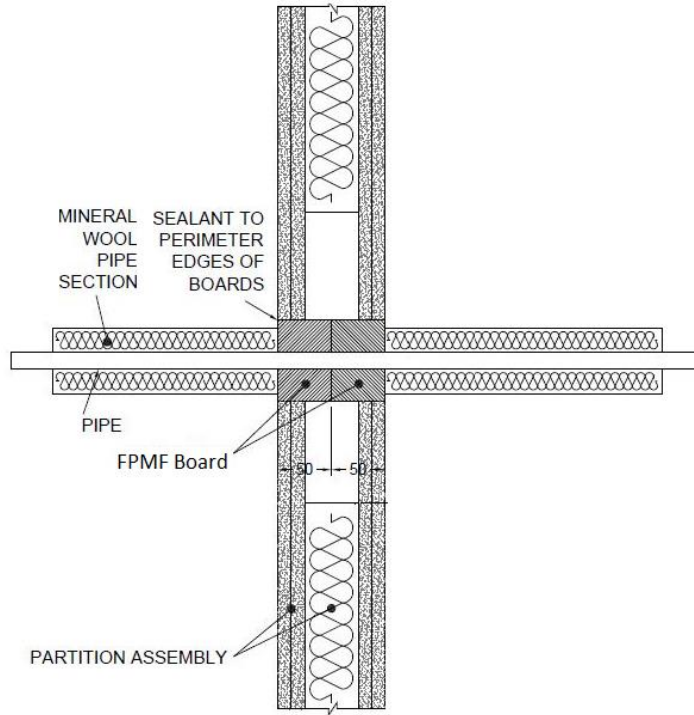

#### A.5.5.1 Two layer penetration seal with pipes

Services	Insulation (minimum thickness and density)	Classification
Copper pipe up to 54 mm diameter/1-14.2 mm wall	20 mm stone wool 80 kg/m <sup>3</sup>	EI 120 C/C
Mild or stainless steel pipe 114 mm diameter/11 mm wall	None	E 90 C/U, EI 20 C/U

Services	Insulation (minimum thickness and density)	Classification
Mild or stainless steel pipe		
40 mm diameter/1-14.2 mm wall	20 mm stone wool 80 kg/m <sup>3</sup>	EI 120 C/U
40 mm diameter/1-14.2 mm wall*	30 mm stone wool 80 kg/m <sup>3</sup>	E 120 C/U, EI 90 C/U
50 mm diameter/1.2-14.2 mm wall*		
60 mm diameter/1.4-14.2 mm wall*		
75 mm diameter/1.7-14.2 mm wall*		
90 mm diameter/2-14.2 mm wall*		
100 mm diameter/2.2-14.2 mm wall*		
115 mm diameter/2.5-14.2 mm wall*		
140 mm diameter/3-14.2 mm wall*		
165 mm diameter/3.5-14.2 mm wall*		
180 mm diameter/3.8-14.2 mm wall*		
200 mm diameter/4.2-14.2 mm wall*		
219 mm diameter/4.5-14.2 mm wall*		

\* Typical pipe diameters shown, see below graph for intermediate sizes

Pipe diameter vs Wall thickness

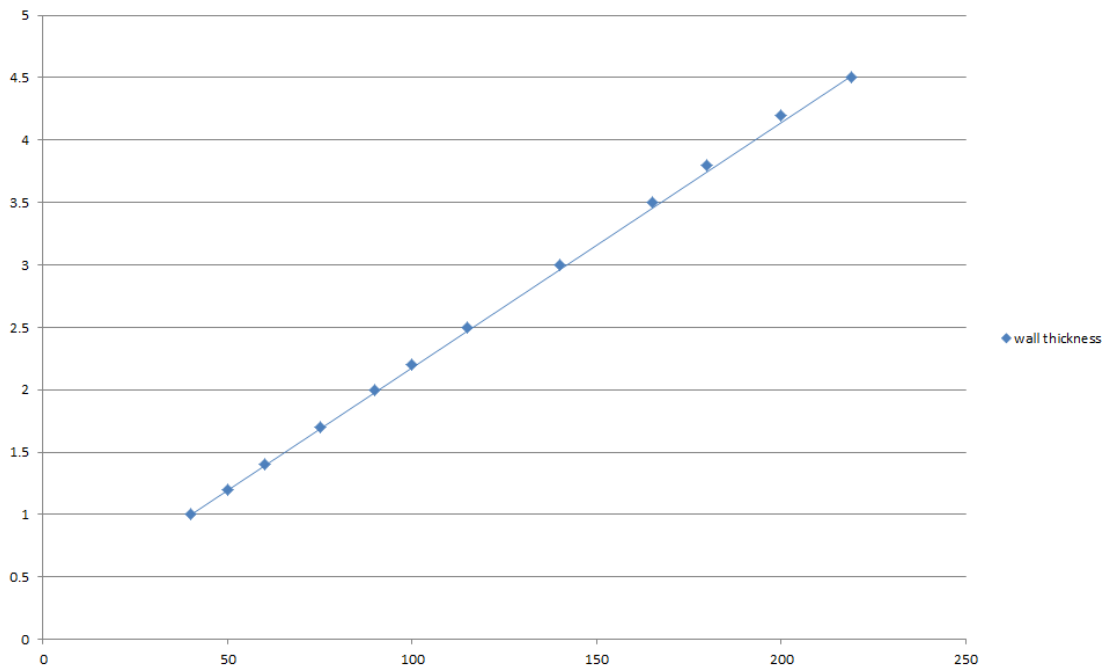

Services	Insulation (minimum thickness and density)	Classification
Alupex pipe	20 mm stone wool 80 kg/m <sup>3</sup>	EI 120 C/C
16 mm diameter/2.25 mm wall		EI 60 C/C
20 mm diameter/2.5 mm wall		
26 mm diameter/3 mm wall		
32 mm diameter/3 mm wall		
40 mm diameter/3.5 mm wall		
50 mm diameter/4 mm wall		
63 mm diameter/4.5 mm wall		
75 mm diameter/4.7 mm wall		

**A.5.6 Pipe penetration seal with 2x FPMF Board 1-S**

**Penetration Seal:** LS (Local Sustained) or CS (Continuous Sustained) insulated metallic and composite pipes fitted at any position within the aperture, with 50 mm FPMF Board 1-S to both sides of the wall. FP Pipe Wraps are required to be fitted around the pipe to both sides of the seal.

Construction details:

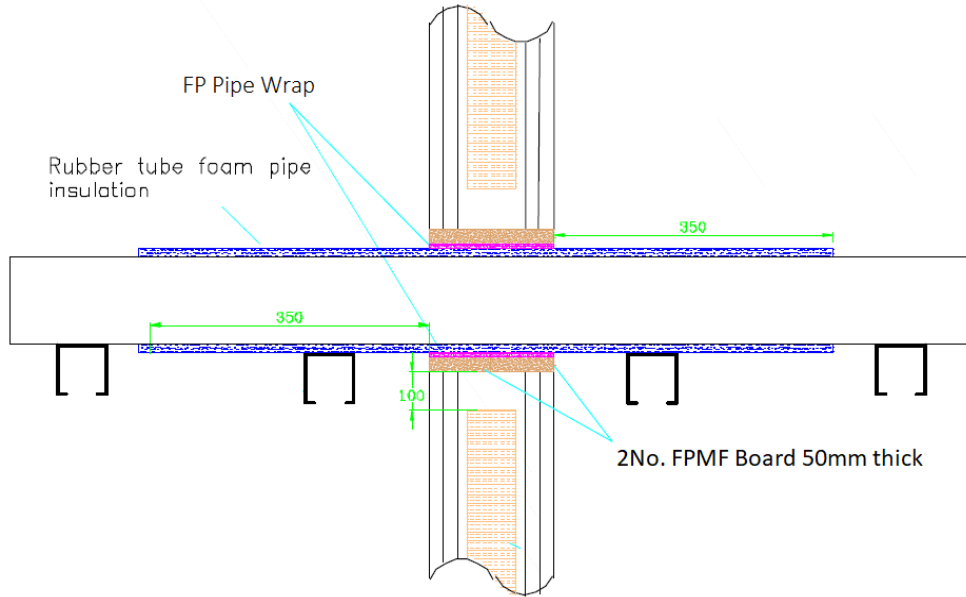

**A.5.6.1 Two layer penetration seal with pipes**

Services	Wrap	Insulation	Classification
Mild or stainless steel pipe	50 x 1.8 mm FP Pipe Wrap fitted to both sides of the seal	15 mm phenolic foam insulation (CS)	<b>EI 90 C/U</b>
16 mm diameter/1.0 mm wall		25-100 mm phenolic foam insulation (CS)	
16-273 mm diameter/1.0-14.2 mm wall*			
<b>Copper pipe</b>			
12 mm diameter/1 mm wall	50 x 3.6 mm FP Pipe Wrap fitted to both sides of the seal	9 mm elastomeric insulation minimum class B-s3, d0 or PE Foam insulation (LS and CS)	<b>EI 120 C/C</b>
12-54 mm diameter/1-1.2 mm wall		9-13 mm elastomeric insulation minimum class B-s3, d0 or PE Foam insulation (LS and CS)	<b>E 120 C/C, EI 90 C/C</b>
12-54 mm diameter/1-1.2 mm wall		13-25 mm elastomeric insulation minimum class B-s3, d0 or PE Foam insulation (LS and CS)	<b>E 120 C/C, EI 60 C/C</b>

\*See below graph for interpolation pipe sizes

### Steel Pipes with Phenolic Foam Insulation - C/U

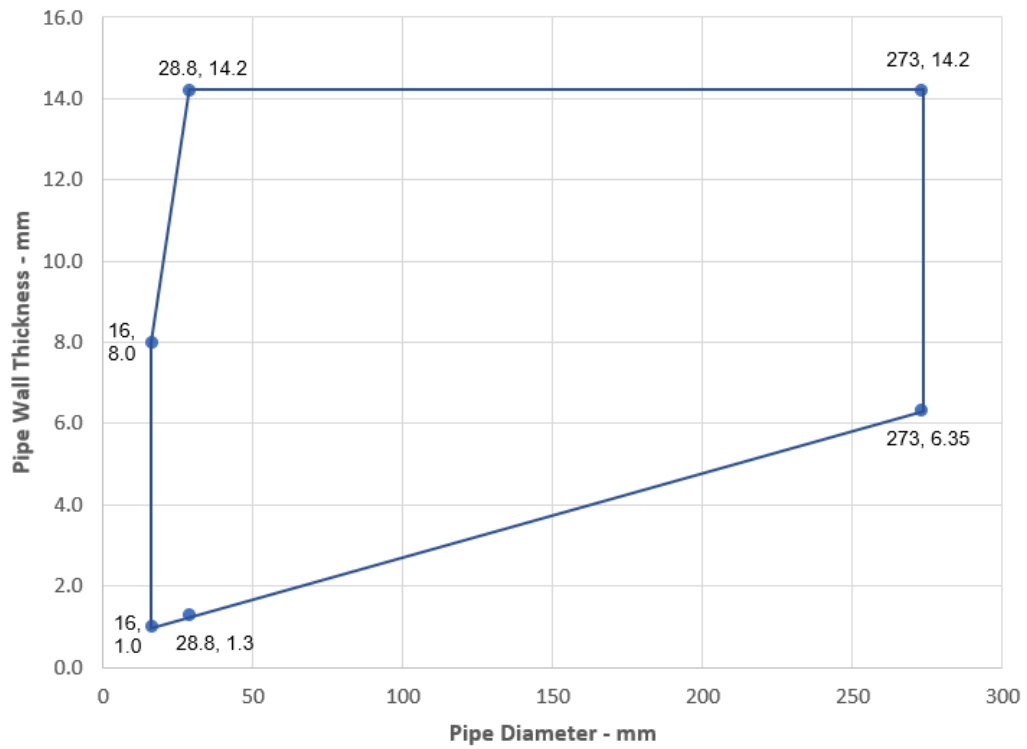

Services	Wrap	Insulation	Classification
Alupex pipe			
16 mm diameter/2.25 mm wall	50 x 3.6 mm FP Pipe Wrap fitted to both sides of the seal	9-25 mm elastomeric insulation minimum class B-s3, d0 or PE Foam insulation	<b>EI 120 C/C</b>
20 mm diameter/2.5 mm wall			
26 mm diameter/3 mm wall			
32 mm diameter/3 mm wall			
40 mm diameter/3.5 mm wall			
50 mm diameter/4 mm wall			
63 mm diameter/4.5 mm wall			
75 mm diameter/4.7 mm wall			
25 mm diameter/2.5 mm wall		13 mm polyethylene foam with plastic sheaving	<b>E 90 C/C, EI 60 C/C</b>

Services	Outer diameter including insulation	Pipe wrap	Pipe insulation	Classification
PE pipe according to EN 1519-1, EN 12201-2 and EN 12006-1, ABS according to EN 1455-1 and pipes made from SAN+PVC according to EN 1565-1				
Maximum 160 mm diameter pipe*	Maximum 68 mm diameter	50 x 3.6 mm FP Pipe Wrap fitted to both sides of the seal	9-50 mm Elastomeric insulation minimum class B-s3, d0 or PE Foam insulation	<b>EI 60 C/C</b>
	Maximum 178 mm diameter	50 x 10.8 mm FP Pipe Wrap fitted to both sides of the seal		
	Maximum 260 mm diameter	50 x 18.0 mm FP Pipe Wrap fitted to both sides of the seal		
PP pipe according to EN 1852-1: 2009				
Maximum 160 mm diameter pipe*	Maximum 68 mm diameter	50 x 3.6 mm FP Pipe Wrap fitted to both sides of the seal	9-50 mm Elastomeric insulation minimum class B-s3, d0 or PE Foam insulation	<b>EI 60 C/C</b>
	Maximum 178 mm diameter	50 x 10.8 mm FP Pipe Wrap fitted to both sides of the seal		
	Maximum 260 mm diameter	50 x 18.0 mm FP Pipe Wrap fitted to both sides of the seal		

\*See below graph for interpolation pipe sizes

**PE Pipes - EI 60 C/C**

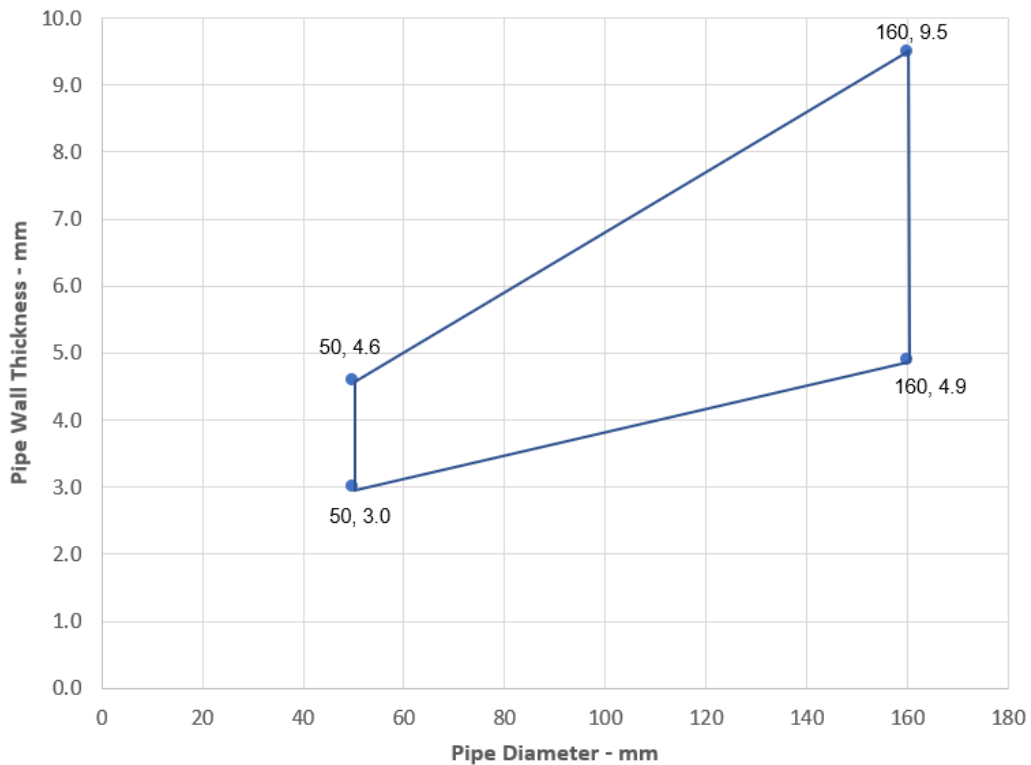

### PP Pipes - EI 60 C/C

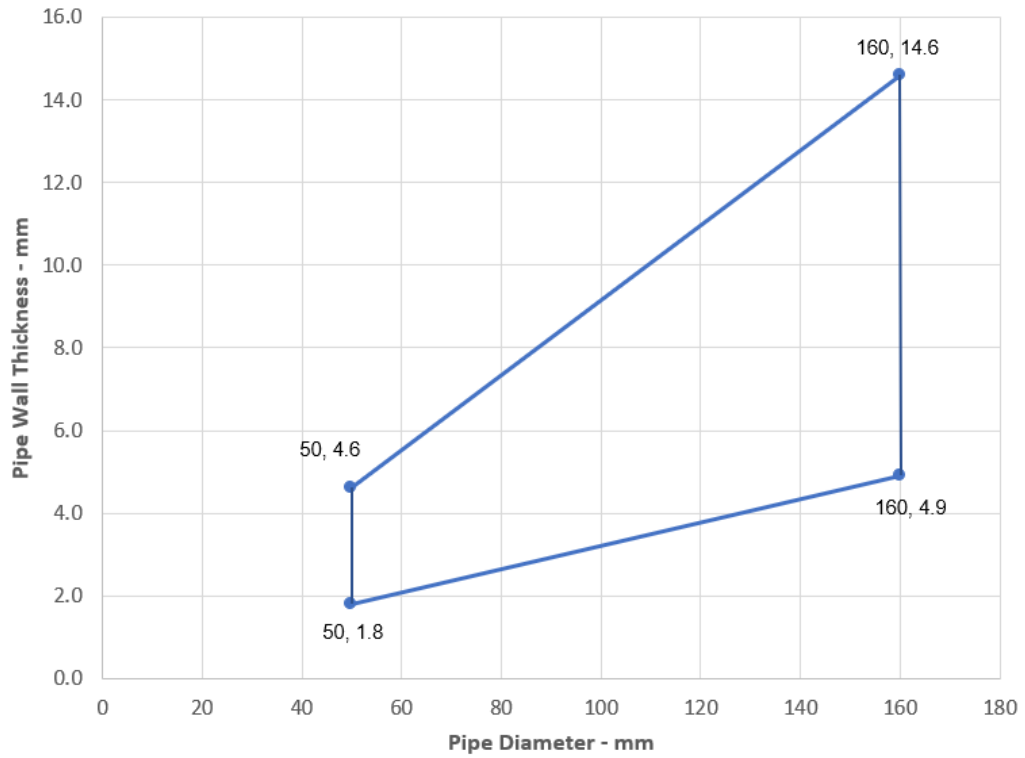

#### A.5.7 FP Pipe Wrap penetration seal for plastic pipes, in 2x FPMF Board 1-S, in flexible or rigid walls

**Penetration Seal:** Combustible pipes sealed with FP Pipe Wrap, to both sides of the wall. Minimum separation between penetration seals and seal edges of 30 mm. (Configuration 1 & 2).

Construction details:

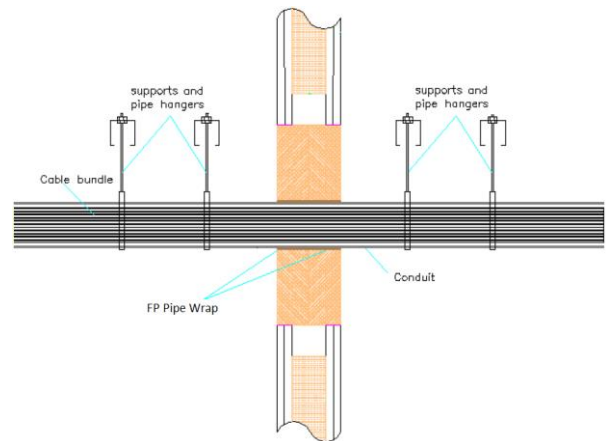
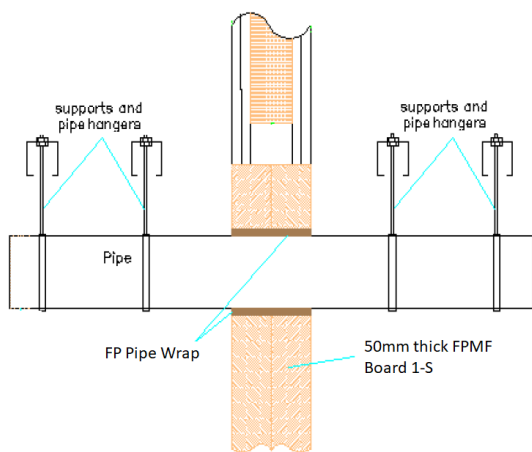



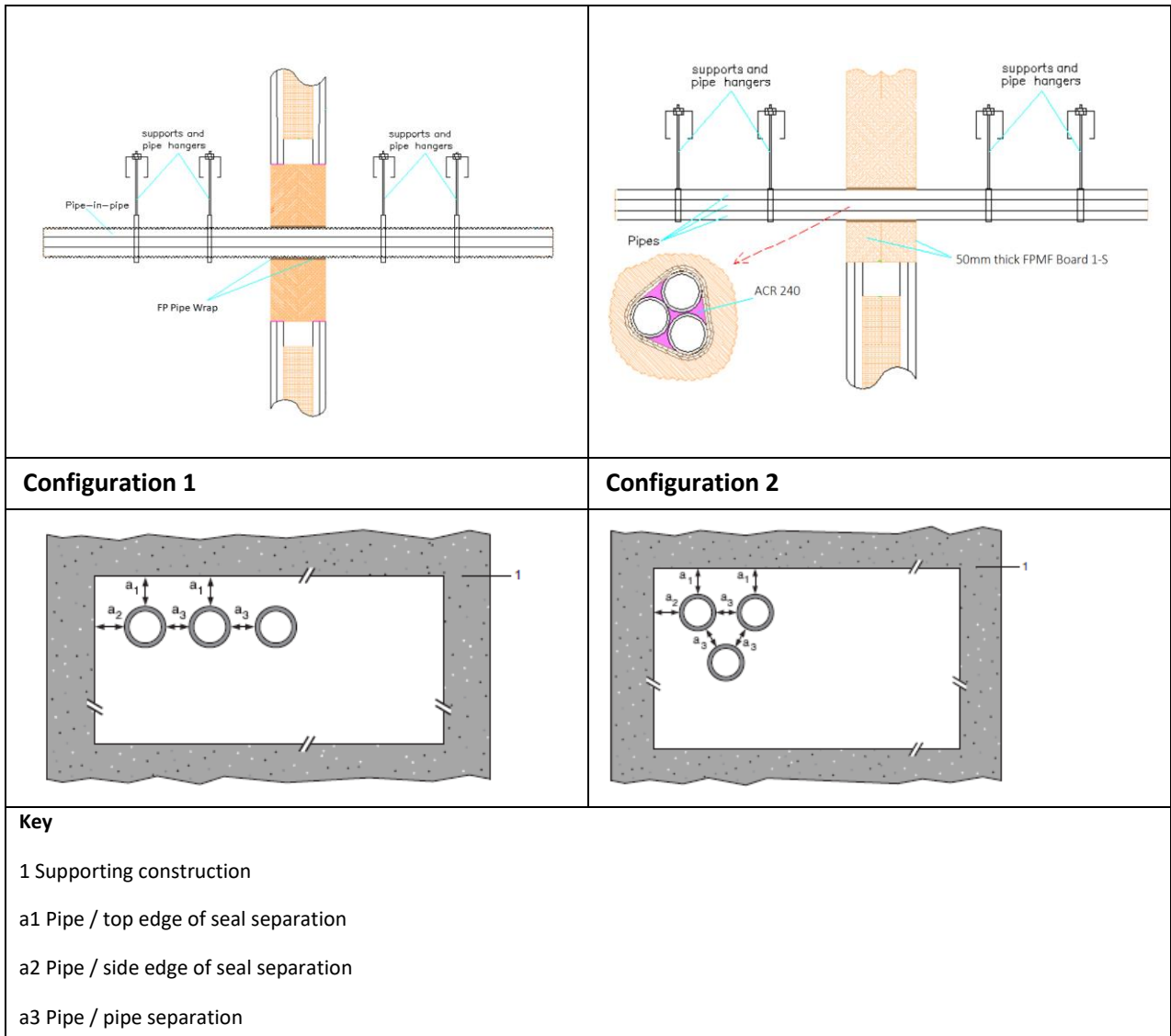

**A.5.7.1**

Services	Wraps (both sides)	Permitted configuration for seal separation	Classification
PVC-U pipe according to EN 1329-1, EN 1452-2 and EN 1453-1 and PVC-C according to EN 1566-1			
Diameter up to 40 mm, wall thickness 1.9 – 3.0 mm	50 x 1.8 mm (1 layer)	1 & 2	EI 120 U/U, EI 120 C/U, EI 120 U/C, EI 120 C/C
Diameter up to 110 mm, wall thickness 2.7 - 6.6 mm	50 x 3.6 mm (2 x 1.8 layer)		E 120 U/C, E 120 C/C EI 90 U/C, EI 90 C/C
Diameter up to 125 mm, wall thickness 3.7 – 7.4 mm	50 x 5.4 mm (3 x 1.8 layer)		
Diameter up to 160 mm, wall thickness 9.5 mm *	50 x 7.2 mm (4 x 1.8 layer)		E 90 U/C, E 90 C/C EI 60 U/C, EI 60 C/C
Diameter up to 160 mm, wall thickness 4.0-9.5 mm *	50 x 10.8 mm (6 x 1.8 layer)		EI 90 C/C
Diameter up to 200 mm, wall thickness 4.9-11.9 mm	50 x 10.8 mm (6 x 1.8 layer)		EI 90 C/C
Diameter up to 315 mm, wall thickness 7.7-12.1 mm*	50 x 18 mm (10 x 1.8 layers)		EI 90 C/C
Diameter up to 400 mm, wall thickness 9.8-15.3 mm*	50 x 28.8 mm (16 x 1.8 layers)		EI 90 C/C

Diameter up to 110 mm, wall thickness 2.7–6.6 mm, fully or partially filled conduits with cables up to 14 mm diameter	50 x 3.6 mm (2 x 1.8 layers)		E 120 U/C, EI 90 U/C	
Diameter up to 32 mm Ø, wall thickness 1.5-2.4 mm with or without cables up to 14 mm Ø, in pipe bundles up to 110 mm Ø <sup>1)</sup>	50 x 3.6 mm (2 x 1.8 layers)		EI 90 U/C	
PE pipe according to EN 1519-1, EN 12201-2 and EN 12006-1, ABS according to EN 1455-1 and pipes made from SAN+PVC according to EN 1565-1				
Diameter up to 40 mm, wall thickness 2.4 – 3.7 mm	50 x 1.8 mm (1 layer)	1 & 2	EI 120 U/U, EI 120 C/U, EI 120 U/C, EI 120 C/C	
Diameter up to 110 mm, wall thickness 4.2 - 10 mm	50 x 3.6 mm (2 x 1.8 layer)		E 120 U/C, E 120 C/C EI 90 U/C, EI 90 C/C	
Diameter up to 125 mm, wall thickness 4.8 – 12 mm	50 x 5.4 mm (3 x 1.8 layer)			
Diameter up to 160 mm, wall thickness 14.6 mm	50 x 7.2 mm (4 x 1.8 layer)			
Diameter up to 160 mm, wall thickness 4.9-14.6 mm	50 x 10.8 mm (6 x 1.8 layer)			E 90 U/C, E 90 C/C EI 60 U/C, EI 60 C/C
Diameter up to 200 mm, wall thickness 6.2-18.2 mm	50 x 10.8 mm (6 x 1.8 layer)			EI 90 C/C
Diameter up to 315 mm, wall thickness 18.7 mm	50 x 18 mm (10 x 1.8 layers)			EI 60 C/C
Diameter up to 400 mm, wall thickness 23.7 mm	50 x 28.8 mm (16 x 1.8 layers)			EI 60 C/C
Diameter up to 110 mm, wall thickness 4.2–10 mm, fully or partially filled conduits with cables up to 14 mm diameter	50 x 3.6 mm (2 x 1.8 layers)			E 120 U/C, EI 90 U/C
Diameter up to 40 mm Ø, wall thickness 2.0-3.7 mm with or without cables up to 14 mm Ø, in pipe bundles up to 110 mm Ø <sup>1)</sup>	50 x 3.6 mm (2 x 1.8 layers)			EI 90 U/C
<b>Services</b>	<b>Wraps (both sides)</b>			<b>Permitted configuration for seal separation</b>
PP pipe according to EN 1852-1: 2009				
Diameter up to 40 mm, wall thickness 1.8 – 5.5 mm	50 x 1.8 mm (1 layer)	1 & 2	EI 120 U/U, EI 120 C/U, EI 120 U/C, EI 120 C/C	
Diameter up to 110 mm, wall thickness 2.7 - 15.1 mm	50 x 3.6 mm (2 x 1.8 layer)		EI 90 U/U, EI 90 C/U, EI 90 U/C, EI 90 C/C	
Diameter up to 125 mm, wall thickness 3.1 – 17.1 mm	50 x 5.4 mm (3 x 1.8 layer)			
Diameter up to 160 mm, wall thickness 21.9 mm	50 x 7.2 mm (4 x 1.8 layer)			
Diameter up to 160 mm, wall thickness 4.9-21.9 mm	50 x 10.8 mm (6 x 1.8 layer)			E 120 U/C, E 120 C/C EI 90 U/C, EI 90 C/C
Diameter up to 200 mm, wall thickness 4.9-18.2 mm	50 x 10.8 mm (6 x 1.8 layer)			EI 60 U/C, EI 60 C/C
Diameter up to 315 mm, wall thickness 28.6 mm	50 x 18 mm (10 x 1.8 layers)			EI 90 C/C
Diameter up to 110 mm, wall thickness 2.7–15.1 mm, fully or partially filled conduits with cables up to 14 mm diameter	50 x 3.6 mm (2 x 1.8 layers)			EI 60 C/C
				E 120 U/C, EI 90 U/C

Diameter up to 40 mm $\emptyset$ , wall thickness 1.8-2.0 mm with or without cables up to 14 mm $\emptyset$ , in pipe bundles up to 110 mm $\emptyset$ <sup>1)</sup>	50 x 3.6 mm (2 x 1.8 layers)		<b>EI 90 U/C</b>
---	------------------------------	--	------------------

<sup>1)</sup> PVC, PE and PP pipes can be mixed in the same bundle.

<b>Services</b>	<b>Wraps (both sides)</b>	<b>Permitted configuration for seal separation</b>	<b>Classification</b>
Uponor Wirsbo PEX double pipe in pipe system according to ISO 15875			
Diameter up to 54 mm/4.0 mm wall thickness (outer pipe), 28 mm diameter/0.4 mm wall thickness (inner pipe)	50 x 3.6 mm (2 x 1.8 layers)	1 & 2	<b>EI 120 C/C</b>
Diameter up to 25 mm pipes, wall thickness 0.6 mm, in bundles up to 50 mm	50 x 3.6 mm (2 x 1.8 layers)		<b>EI 90 C/C</b>
<b>Uponor Decibel pipe according to EN 1451-1</b>			
50 mm diameter/2.0 mm wall thickness	50 x 3.6 mm (2 x 1.8 layers)	1 & 2	<b>EI 90 U/U</b>
75-110 mm diameter/2.6-3.8 mm wall thickness	50 x 3.6 mm (2 x 1.8 layers)		<b>EI 90 U/C</b>
<b>BluePower Multilayer pipe according to EN 1451-1</b>			
32-50 mm diameter/1.8 mm wall thickness*	50 x 3.6 mm (2 x 1.8 layers)	1 & 2	<b>EI 90 U/U</b>
75-110 mm diameter/3.4 mm wall thickness*	50 x 3.6 mm (2 x 1.8 layers)		<b>EI 90 C/U</b>
125-160 mm diameter/3.9-4.9 mm wall thickness	50 x 10.8 mm (6 x 1.8 layers)		<b>EI 90 U/C</b>

Services	Wraps (both sides)	Permitted configuration for seal separation	Classification
<b>Rehau Raupiano Plus PP-DD according to DIN 4102</b>			
40-50 mm diameter/1.8-2.7 mm wall thickness*	50 x 3.6 mm (2 x 1.8 layers)	1 & 2	EI 120 U/U
75-110 mm diameter/2.7 mm wall thickness*	50 x 3.6 mm (2 x 1.8 layers)		EI 120 U/C
125 mm diameter/3.9 mm wall thickness	50 x 7.2 mm (4 x 1.8 layers)		EI 120 U/C
160 mm diameter/3.9 mm wall thickness	50 x 10.8 mm (6 x 1.8 layers)		EI 120 U/C
<b>Polo-Kal NG Poloplast PP-MV according to DIN 4102</b>			
32-50 mm diameter/2.0-3.4 mm wall thickness*	50 x 3.6 mm (2 x 1.8 layers)	1 & 2	EI 120 U/U
75-110 mm diameter/3.4 mm wall thickness*	50 x 3.6 mm (2 x 1.8 layers)		EI 120 U/C
125 mm diameter/3.9 mm wall thickness	50 x 7.2 mm (4 x 1.8 layers)		EI 120 U/C
160 mm diameter/4.9 mm wall thickness	50 x 10.8 mm (6 x 1.8 layers)		EI 120 U/C
<b>Aquatherm Green SDR9 MF PP-RP according to ISO 21003</b>			
32 mm diameter/3.0 mm wall thickness	50 x 1.8 mm (1 x 1.8 layer)	1 & 2	E 120 C/C, EI 90 C/C
40-50 mm diameter/5.6-12.3 mm wall thickness*	50 x 3.6 mm (2 x 1.8 layers)		E 120 C/C, EI 90 C/C
63-110 mm diameter/12.3 mm wall thickness*	50 x 3.6 mm (2 x 1.8 layers)		E 120 C/C, EI 90 C/C
<b>Wavin SiTech + PP-M B according to EN 13501-1</b>			
32-50 mm diameter/1.8-3.4 mm wall thickness*	50 x 3.6 mm (2 x 1.8 layers)	1 & 2	E 120 U/U, EI 90 U/U
75-110 mm diameter/3.4 mm wall thickness*	50 x 3.6 mm (2 x 1.8 layers)		E 120 U/C, EI 60 U/C
<b>Gilbert Silent PP according to DIN 4102</b>			
32-50 mm diameter/1.8-3.4 mm wall thickness*	50 x 3.6 mm (2 x 1.8 layers)	1 & 2	EI 120 U/U
75-110 mm diameter/3.4 mm wall thickness*	50 x 3.6 mm (2 x 1.8 layers)		EI 120 U/C

\*See below graph for interpolation pipe sizes

### PVC-U Pipes - E 90 C/C, EI 60 C/C

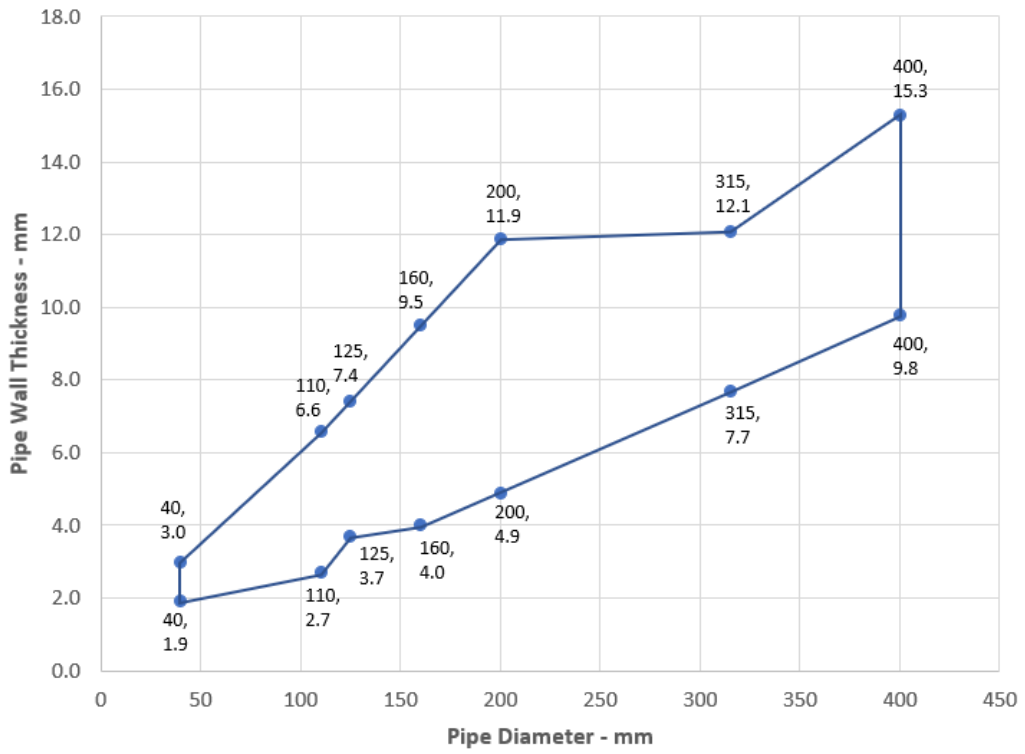

### BluePower Pipes - EI 90 U/C

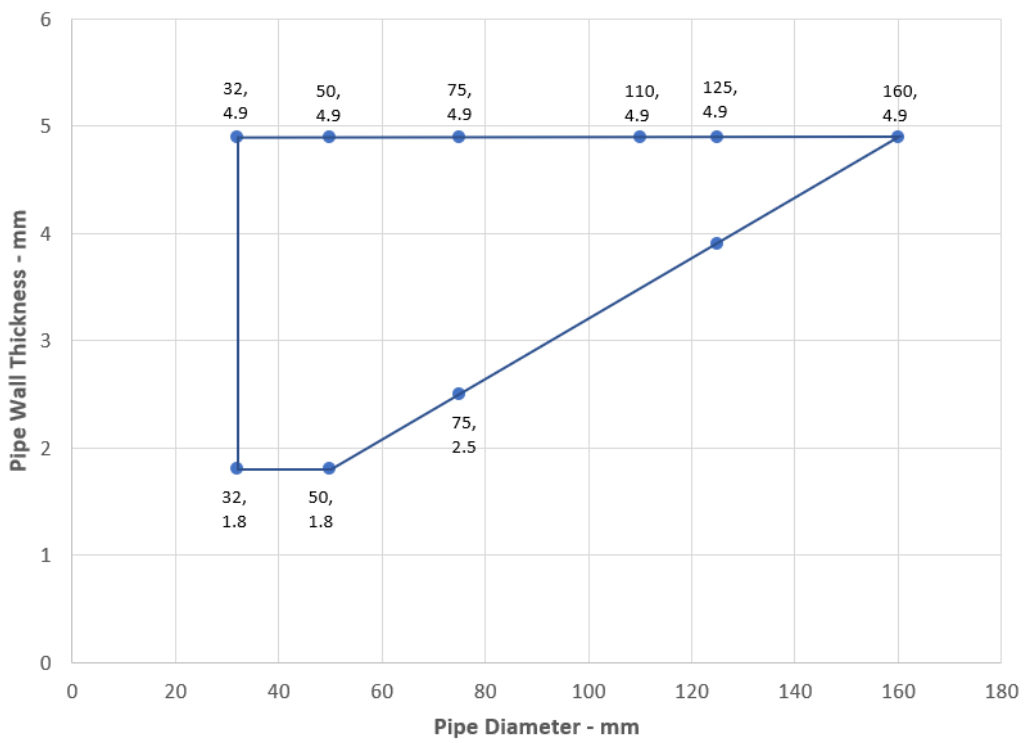

### Rehau Raupiano Plus -EI 120 U/C

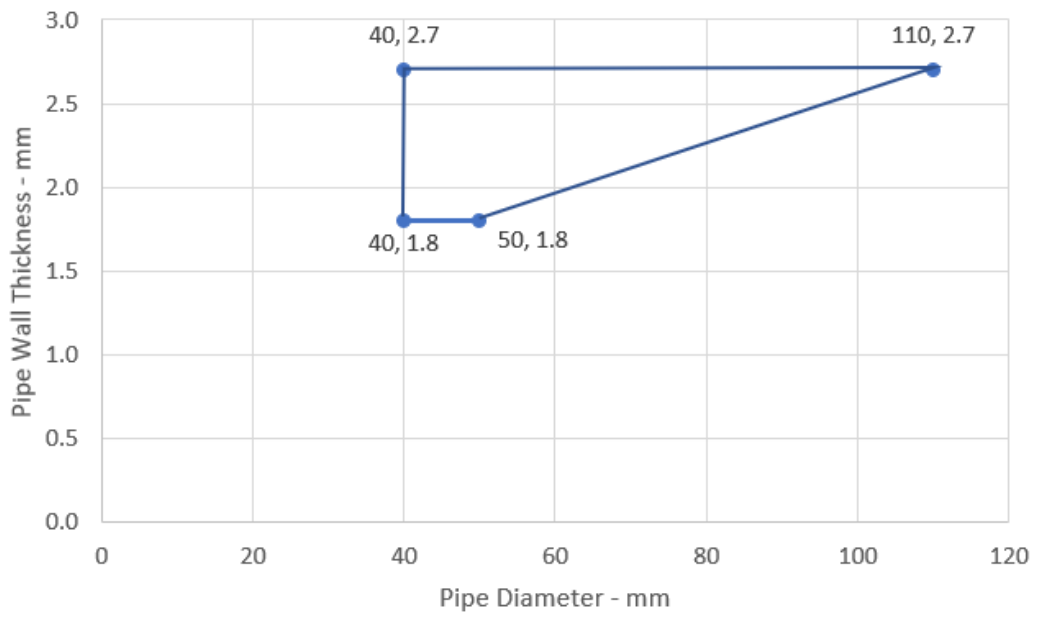

### Polo-Kal NG - EI 120 U/C

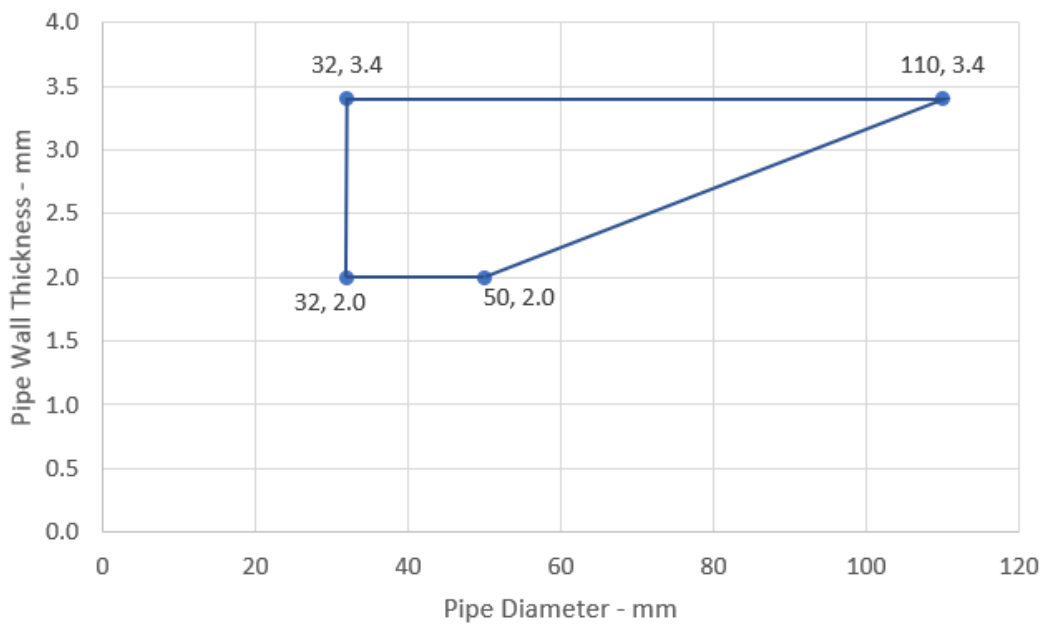

### Aquatherm Green - E 120 C/C, EI 90 C/C

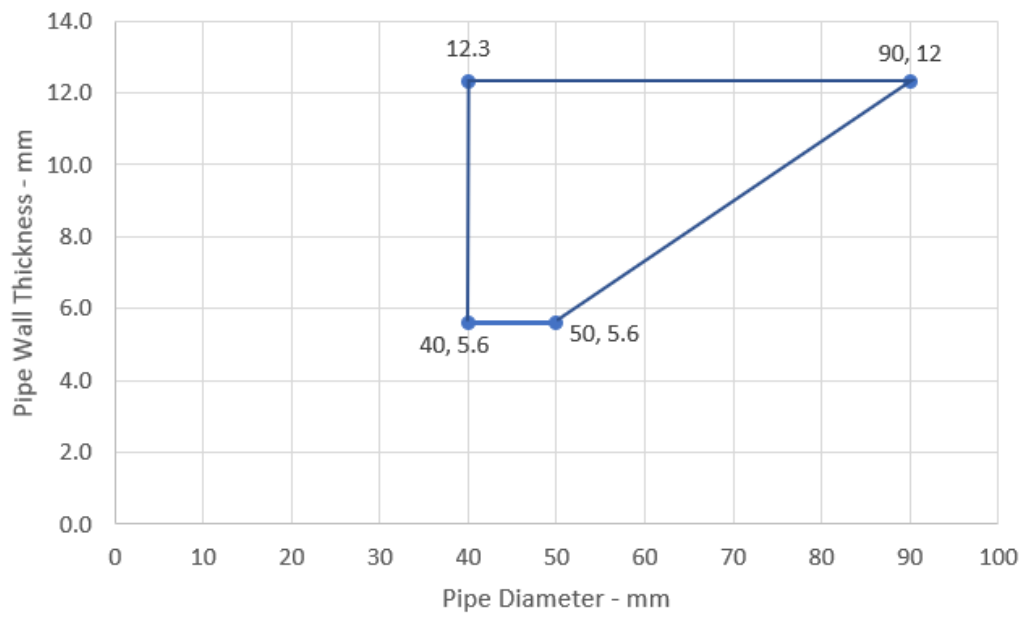

### Wavin SiTech Pipes - E120 C/C, EI 60 C/C

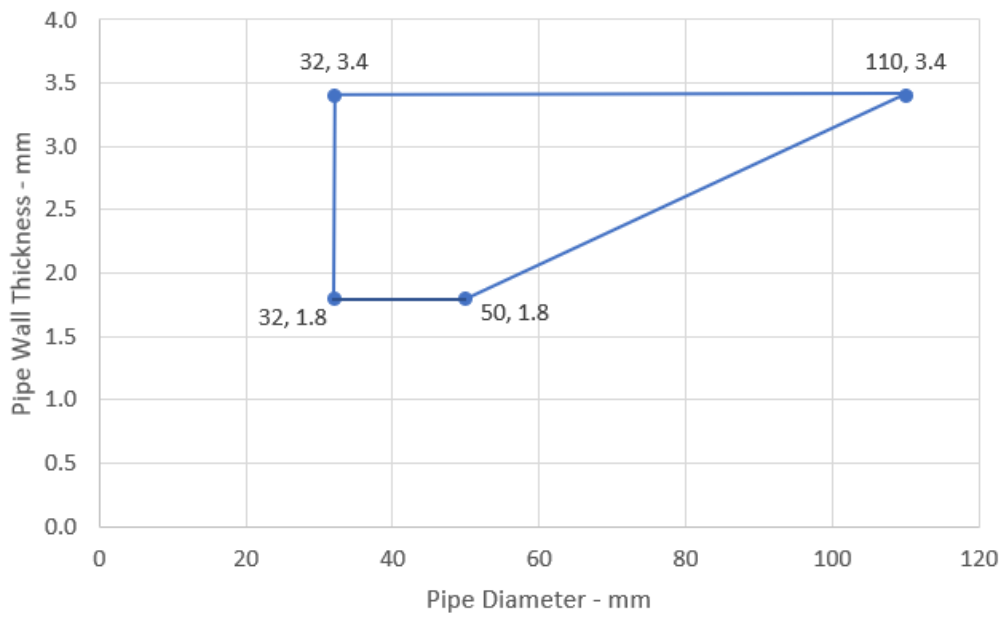

### Gilbert Silent PP - EI 120 U/C

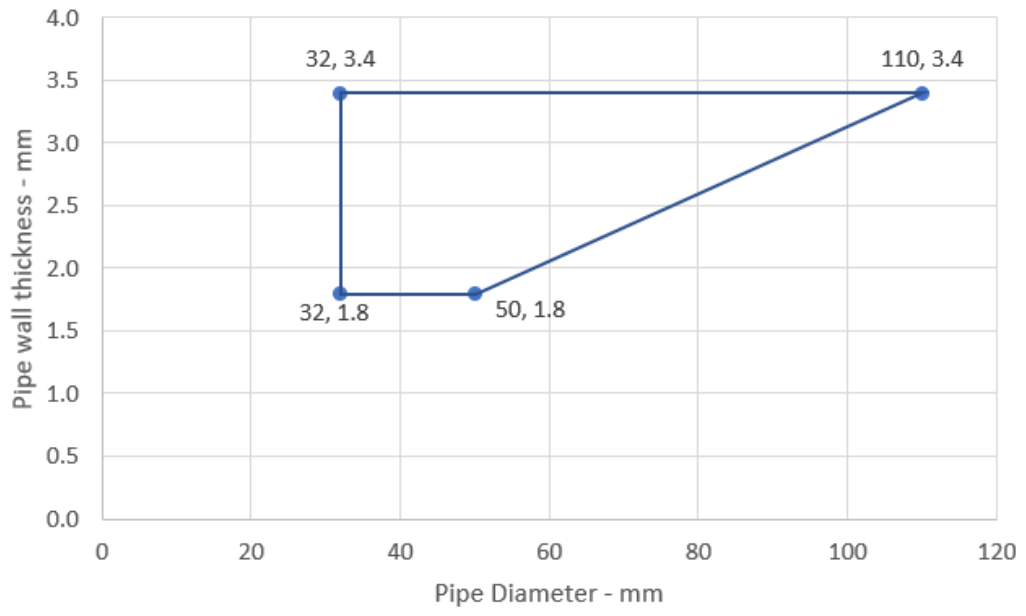



**A.5.8 FPMF Service Coating penetration seal for steel pipes, in 2x FPMF Board 1-S, in flexible or rigid walls**

**Penetration Seal:** Metallic pipes with FPMF Service Coating fitted at any position within the aperture, with 50 mm FPMF Board 1-S to both sides of the wall. Minimum separation between penetration seals and seal edges of 30 mm. (Configuration 1 & 2).

Construction details:

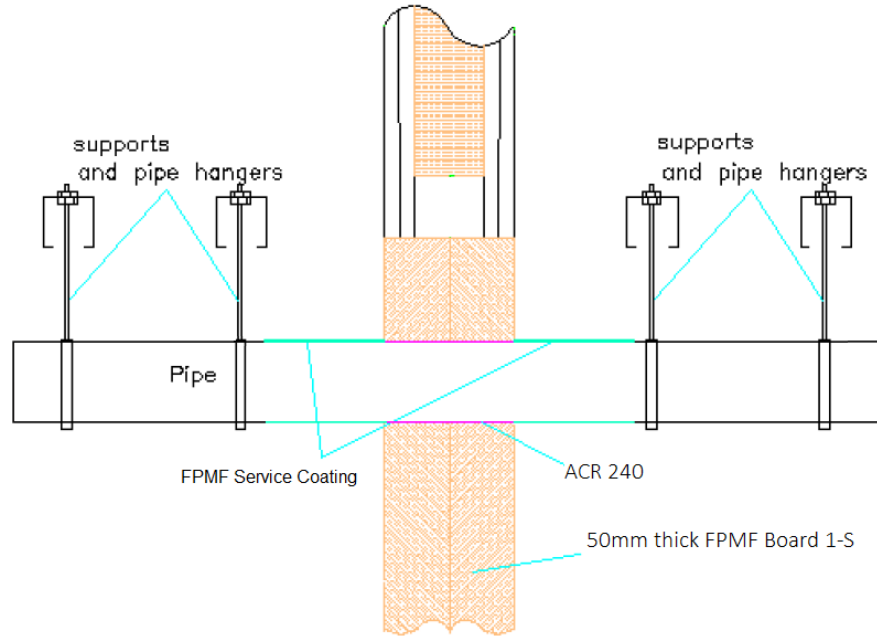

**Configuration 1**

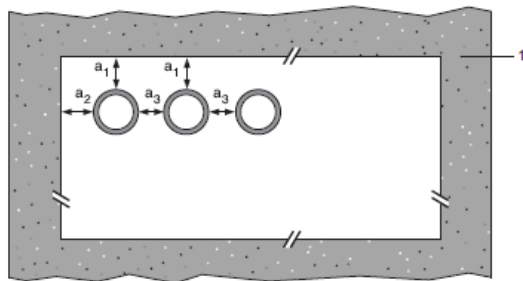

**Configuration 2**

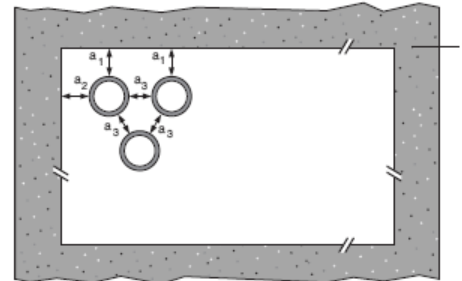

**Key**

- 1 Supporting construction
- a1 Pipe / top edge of seal separation
- a2 Pipe / side edge of seal separation
- a3 Pipe / pipe separation

**A.5.8.1**

Services	Insulation, minimum	Classification
Mild or stainless steel pipe		
Maximum 63 mm diameter*	FPMF Service Coating, 750-micron DFT extending 200 mm from both faces of the FPMF Board fire seal	<b>EI 120 C/C</b>
	FPMF Service Coating, 1500-micron DFT extending 200 mm from both faces of the FPMF Board fire seal	<b>E 90 C/U, EI 60 C/U</b>
Maximum 114 mm diameter	FPMF Service Coating, 1000-micron DFT extending 200 mm from both faces of the FPMF Board fire seal	<b>E 120 C/U, EI 45 C/U</b>

\* Typical pipe diameters shown, see below graph for intermediate sizes

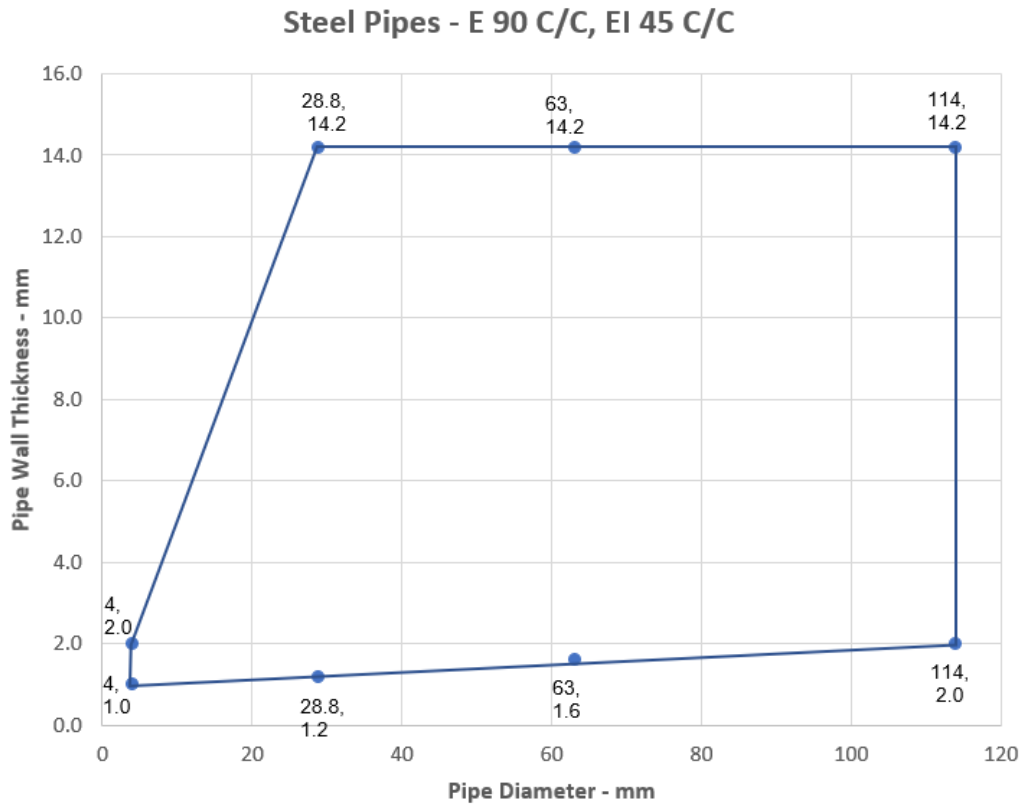

### A.5.9 Penetration seal with 1x FPMF Board 50 2-S in framed aperture

**Penetration Seal:** Services fitted at any position within the aperture, with 50 mm FPMF Board 2-S positioned to either face of the wall (or anywhere in between). Minimum 30 mm separation between pipes. FP Pipe Collars fixed with 50mm pigtail screws. Cables and cable trays coated 150mm each side of FPMF Board with nominally 300µm WFT FPMF Service Coating. In rigid wall constructions the wall thickness can be minimum 75 mm.

**Construction details:**

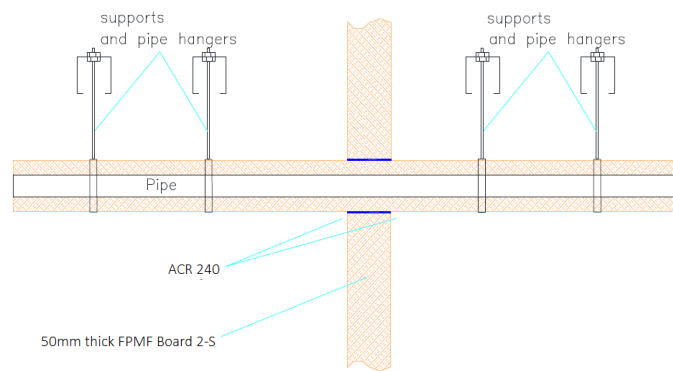
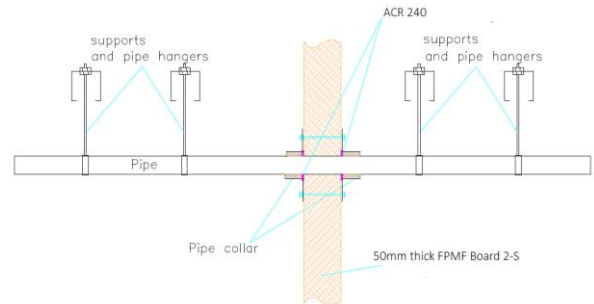
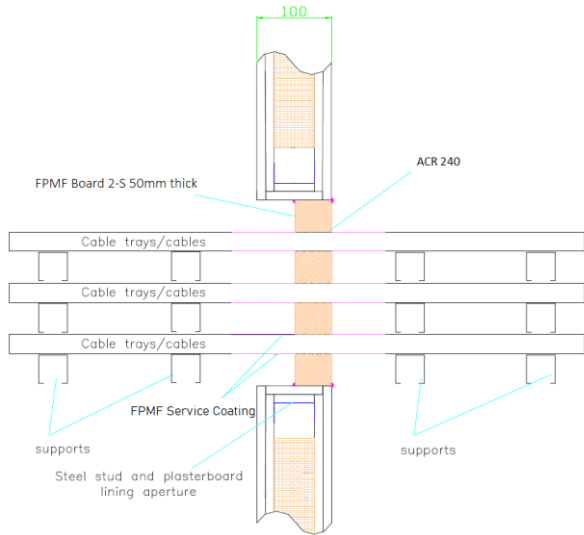

#### A.5.9.1 Single side penetration seal with cables

Services	Maximum aperture	Classification
Electrical cables up to 80 mm Ø (single, bundled and on trays)	1200 mm wide x 600 mm high	EI 60
Cables up to 21mm Ø in tied bundles up to 100mm Ø		EI 60
Perforated Steel cable trays & ladders		E 60, EI 45
Unperforated steel cable trays		E 60, EI 45
Unsheathed wires up to 24 mm Ø		E 60, EI 45

**A.5.9.2 Single side penetration seal with metallic pipes**

Services	Maximum Aperture	Insulation CS	Classification
Mild or stainless steel pipe	1200 mm wide x 600 mm high	20 mm Stone wool insulation min. 80 kg/m <sup>3</sup>	<b>E 90 C/U, EI 60 C/U</b>
40 mm diameter/1.0-14.2 mm wall*			
40 mm diameter/1.0-14.2 mm wall*		30 mm Stone wool insulation min. 80 kg/m <sup>3</sup>	
50 mm diameter/1.7-14.2 mm wall*			
60 mm diameter/1.8-14.2 mm wall*			
75 mm diameter/2.1-14.2 mm wall*			
90 mm diameter/2.3-14.2 mm wall*			
100 mm diameter/2.5-14.2 mm wall*			
115 mm diameter/2.8-14.2 mm wall*			
140 mm diameter/3.2-14.2 mm wall*			
165 mm diameter/ 3.6-14.2 mm wall*			
180 mm diameter/ 3.9-14.2 mm wall*			
200 mm diameter/ 4.2-14.2 mm wall*			
219 mm diameter/ 4.5-14.2 mm wall*			
250 mm diameter/ 5.0-14.2 mm wall*			
300 mm diameter/ 5.9-14.2 mm wall*			
324 mm diameter/ 6.35-14.2 mm wall*			

\* Typical pipe diameters shown, see below graph for intermediate sizes

CS – Continuous Sustained

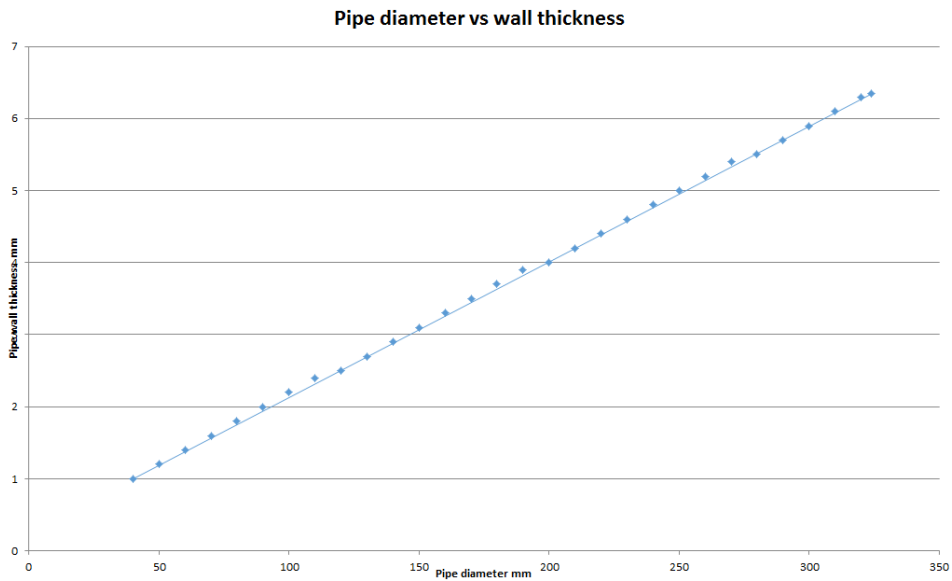

Services	Maximum Aperture	Insulation CS	Classification
----------	------------------	---------------	----------------

Copper pipe maximum 54 mm diameter*	1200 mm wide x 600 mm high	20-40 mm glass or stone wool insulation min. 75 kg/m <sup>3</sup>	<b>E 60 C/C, EI 30 C/C</b>
Alupex pipe maximum 16 mm diameter/2.25 mm wall		20 mm glass or stone wool insulation min. 75 kg/m <sup>3</sup>	<b>E60 C/C, EI 45 C/C</b>
Alupex pipe maximum 75 mm diameter/4.6 mm wall		25 mm glass or stone wool insulation min. 75 kg/m <sup>3</sup>	<b>EI 60 C/C</b>

\*See below graph for interpolation pipe sizes

**Copper Pipes - E 60 C/C, EI 30 C/C**

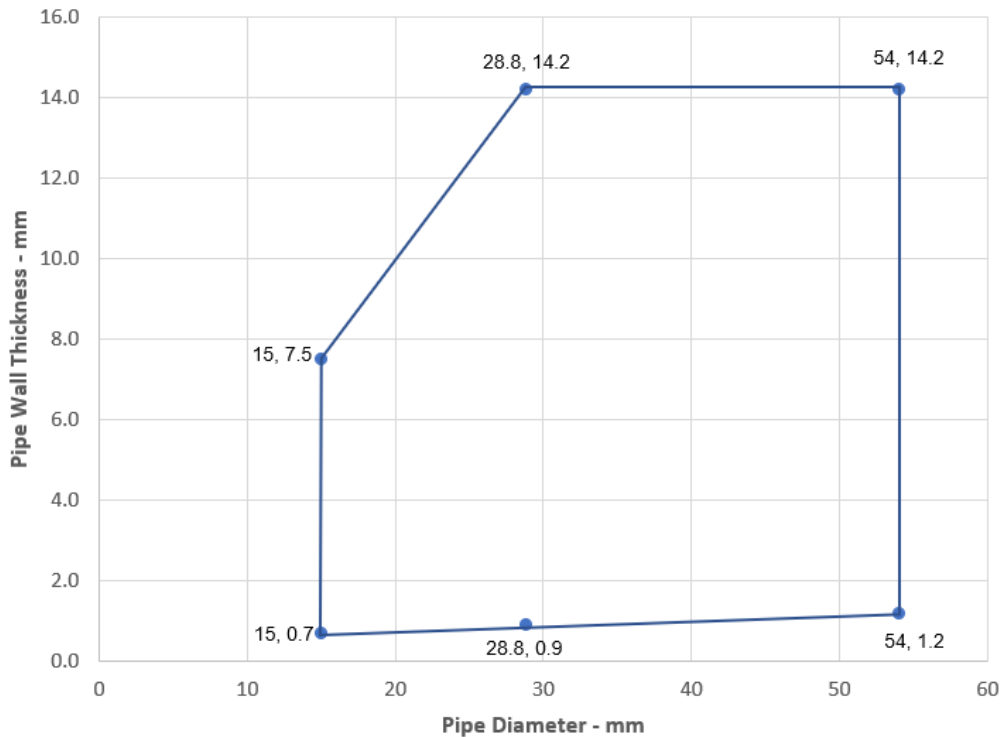

Services	Maximum Aperture	Insulation LI or CI	Classification
Copper pipe maximum 54 mm diameter*	1200 mm wide x 600 mm high	Min. 500 mm length, min. 20 mm thick glass or stone wool insulation 75 kg/m <sup>3</sup>	<b>E 60 C/C, EI 45 C/C</b>

\*See below graph for interpolation pipe sizes

### Copper Pipes - E 60 C/C, EI 45 C/C

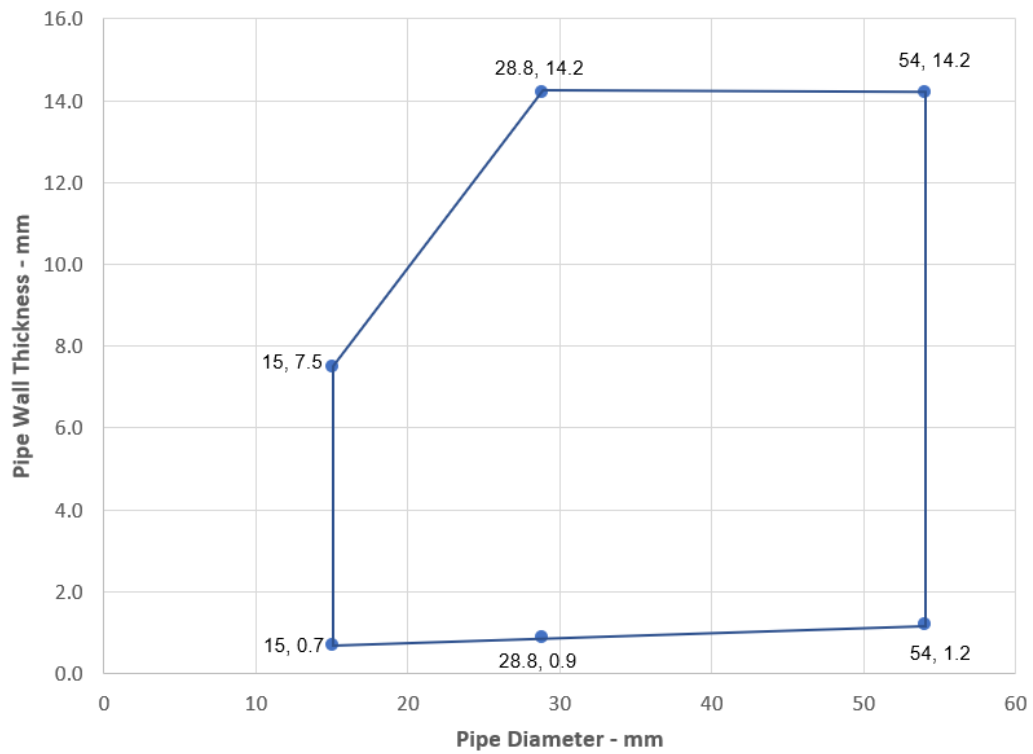

Services	Collar	Insulation CS	Classification
Copper pipe			
Maximum 54 mm diameter*	Maximum 110 mm diameter/50 mm high	9-25 mm elastomeric insulation min. class B-s3, d0 or PE Foam insulation	<b>E 60 C/C, EI 30 C/C</b>
Alupex pipe			
Maximum 16 mm diameter, wall thickness 2.25 mm	Maximum 40 mm diameter/50 mm high	9 mm elastomeric insulation	<b>EI 60 C/C</b>
Maximum 75 mm diameter, wall thickness 2.25-4.6 mm	Maximum 110 mm diameter/50 mm high	min. class B-s3, d0 or PE Foam insulation	<b>E 60 C/C, EI 45 C/C</b>
Maximum 75 mm diameter, wall thickness 2.25-4.6 mm	125 mm diameter/ 60mm high	25 mm elastomeric insulation min. class B-s3, d0 or PE Foam insulation	<b>EI 60 C/C</b>

\*See below graph for interpolation pipe sizes

## Copper Pipes - E 60 C/C, EI 30 C/C

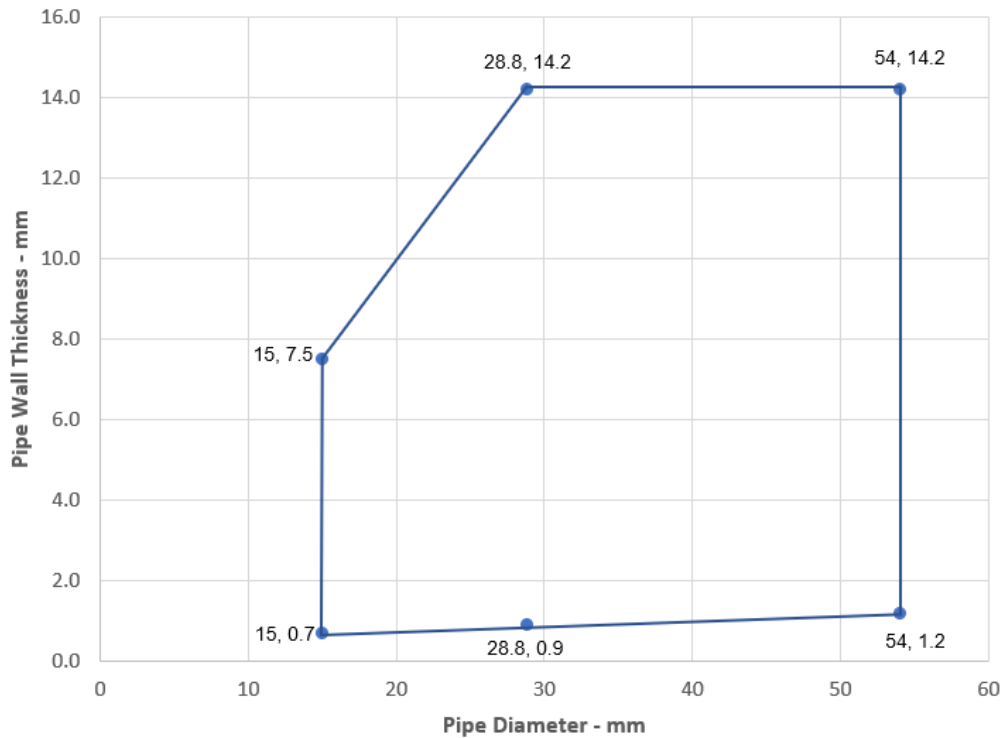

## A.5.9.3 Single side penetration seal with plastic pipes

Services	Collar Inlay	Classification
PVC-U pipe according to EN 1329-1, EN 1452-1 and EN 1453-1 and PVC-C according to EN 1566-1		
Diameter 32 mm, wall thickness 1.9 mm	30 x 3.0 mm	E 90 U/C, EI 45 U/C
Diameter 40 mm, wall thickness 1.9 mm	30 x 3.0 mm	
Diameter 50 mm, wall thickness 3.7-6.6 mm	30 x 3.0 mm	E 90 U/C, EI 30 U/C
Diameter 55 mm, wall thickness 3.7-6.6 mm	30 x 3.2 mm	
Diameter 63 mm, wall thickness 3.7-6.6 mm	30 x 3.6 mm	
Diameter 75 mm, wall thickness 3.7-6.6 mm	30 x 4.2 mm	
Diameter 82 mm, wall thickness 3.7-6.6 mm	30 x 4.6 mm	
Diameter 90 mm, wall thickness 3.7-6.6 mm	30 x 5.0 mm	
Diameter 110 mm, wall thickness 2.7-6.6 mm	30 x 6.0 mm	E 120 U/C, EI 60 U/C
32 mm diameter*	50 x 3.0 mm	
40 mm diameter *	50 x 3.0 mm	
50 mm diameter *	50 x 3.0 mm	
55 mm diameter *	50 x 3.2 mm	E 90 U/C, EI 60 U/C
63 mm diameter *	50 x 3.6 mm	
75 mm diameter *	50 x 4.2 mm	
82 mm diameter *	50 x 4.6 mm	
90 mm diameter *	50 x 5.0 mm	
110 mm diameter *	50 x 6.0 mm	
125 mm diameter*	60 x 9.0 mm	EI 60 C/C
140 mm diameter*	60 x 11.5 mm	
160 mm diameter*	60 x 15.0 mm	

\*See below graph for interpolation pipe sizes

### PVC Pipes 32-110 / 50 mm Collar - C/C

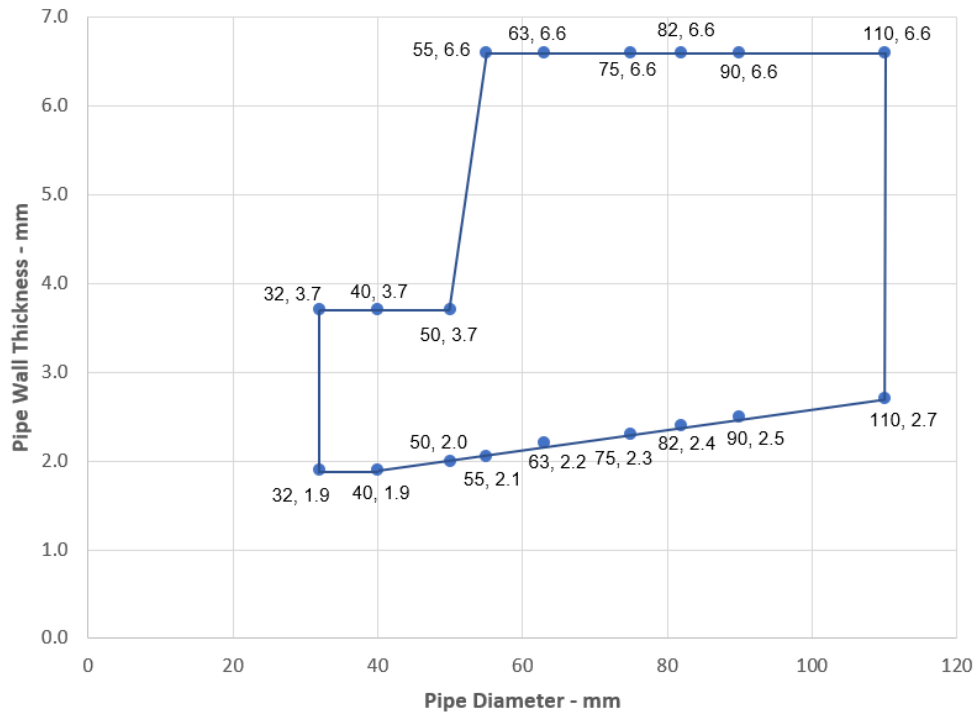



### PVC Pipes 110-160 / 60 mm Collar - C/C

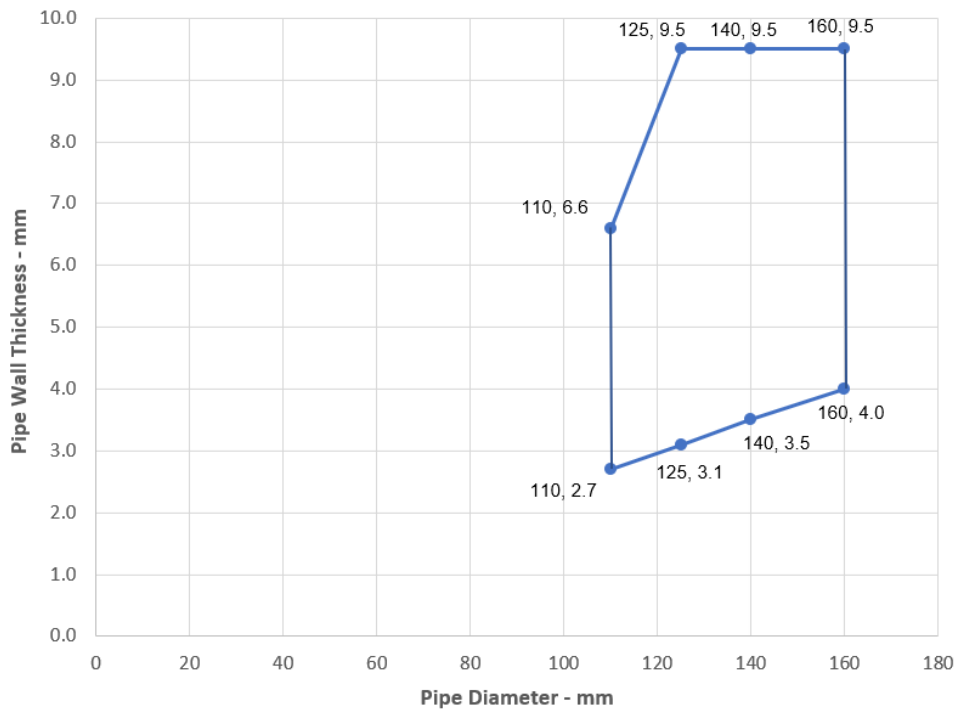

Services	Collar Inlay	Classification
PE pipe according to EN 1519-1, EN 12201-2 and EN 12666-1, ABS according to EN 1455-1 and pipes made from SAN+PVC according to EN 1565-1		
Diameter 32 mm, wall thickness 3.4-10.0 mm	30 x 3.0 mm	<b>E 60 U/C, EI 45 U/C</b>
Diameter 40 mm, wall thickness 3.4-10.0 mm	30 x 3.0 mm	
Diameter 50 mm, wall thickness 3.4-10.0 mm	30 x 3.0 mm	
Diameter 55 mm, wall thickness 3.4-10.0 mm	30 x 3.2 mm	
Diameter 63 mm, wall thickness 3.4-10.0 mm	30 x 3.6 mm	
Diameter 75 mm, wall thickness 3.4-10.0 mm	30 x 4.2 mm	
Diameter 82 mm, wall thickness 3.4-10.0 mm	30 x 4.6 mm	
Diameter 90 mm, wall thickness 3.4-10.0 mm	30 x 5.0 mm	
Diameter 110 mm, wall thickness 3.4-10.0 mm	30 x 6.0 mm	
32 mm diameter*	50 x 3.0 mm	<b>E 120 U/C, 60 U/C</b>
40 mm diameter*	50 x 3.0 mm	
50 mm diameter*	50 x 3.0 mm	
55 mm diameter*	50 x 3.2 mm	<b>E 90 C/C, EI 60 C/C</b>
63 mm diameter*	50 x 3.6 mm	
75 mm diameter*	50 x 4.2 mm	
82 mm diameter*	50 x 4.6 mm	
90 mm diameter*	50 x 5.0 mm	
110 mm diameter*	50 x 6.0 mm	
125 mm diameter*	60 x 9.0 mm	<b>EI 60 C/C</b>
140 mm diameter*	60 x 11.5 mm	
160 mm diameter*	60 x 15.0 mm	

\*See below graph for interpolation pipe sizes

### PE Pipes 32-110 / 50 mm Collar - U/C

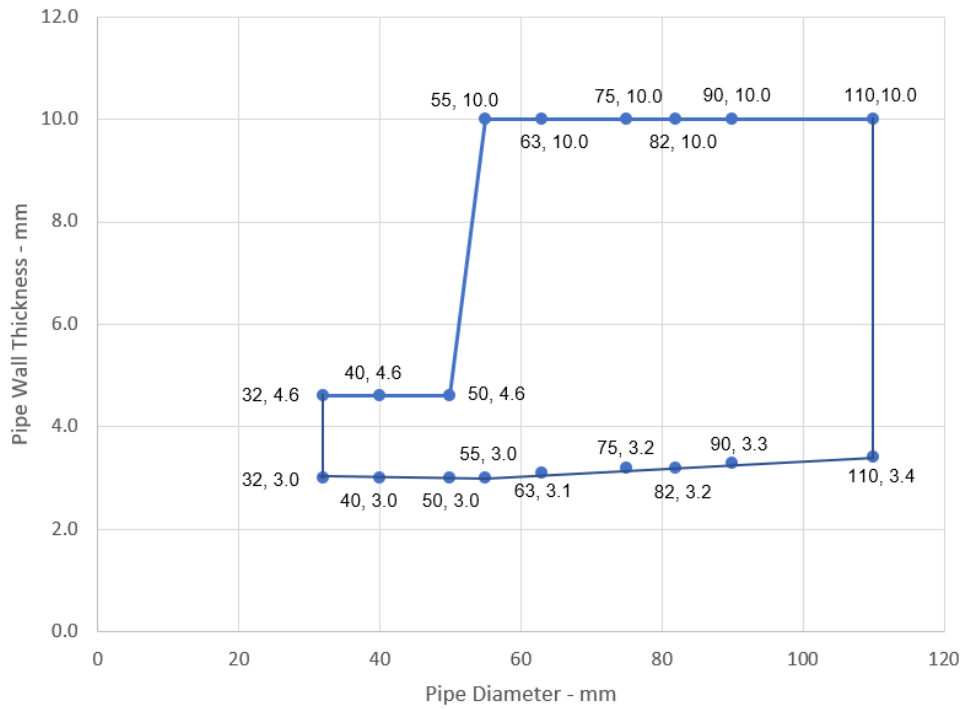

### PE Pipes 110-160 / 60 mm Collar - C/C

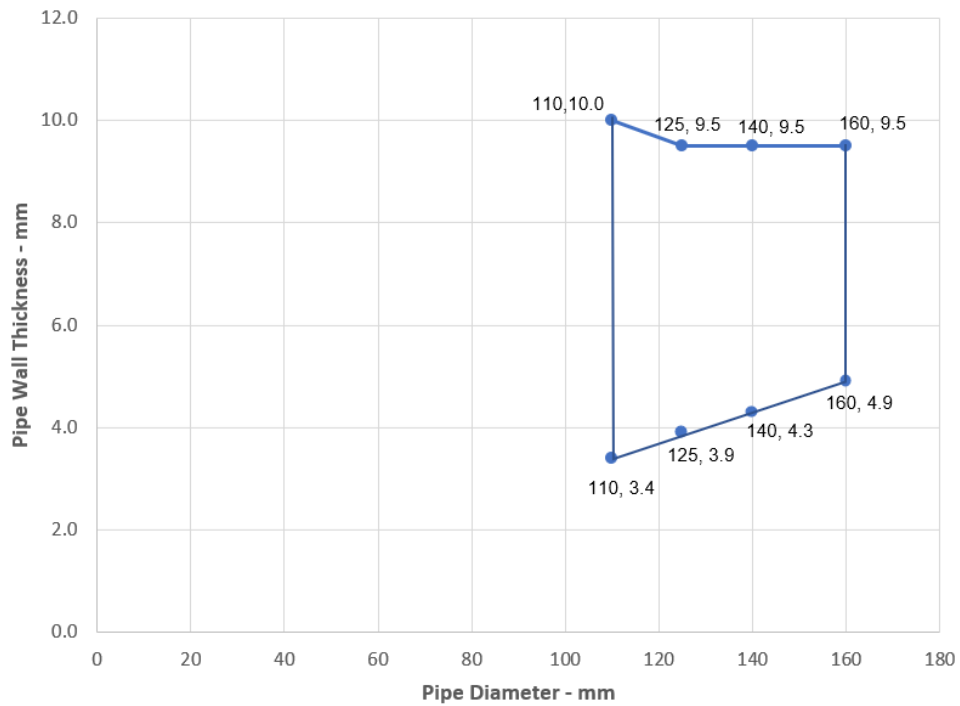

Services	Collar Inlay	Classification
PP pipe according to EN 1852-1: 2009		
32 mm diameter*	50 x 3.0 mm	<b>EI 60 C/C</b>
40 mm diameter*	50 x 3.0 mm	
50 mm diameter*	50 x 3.0 mm	
55 mm diameter*	50 x 3.2 mm	
63 mm diameter*	50 x 3.6 mm	
75 mm diameter*	50 x 4.2 mm	
82 mm diameter*	50 x 4.6 mm	
90 mm diameter*	50 x 5.0 mm	
110 mm diameter*	50 x 6.0 mm	
125 mm diameter*	60 x 9.0 mm	
140 mm diameter*	60 x 11.5 mm	
160 mm diameter*	60 x 15.0 mm	

\*See below graph for interpolation pipe sizes

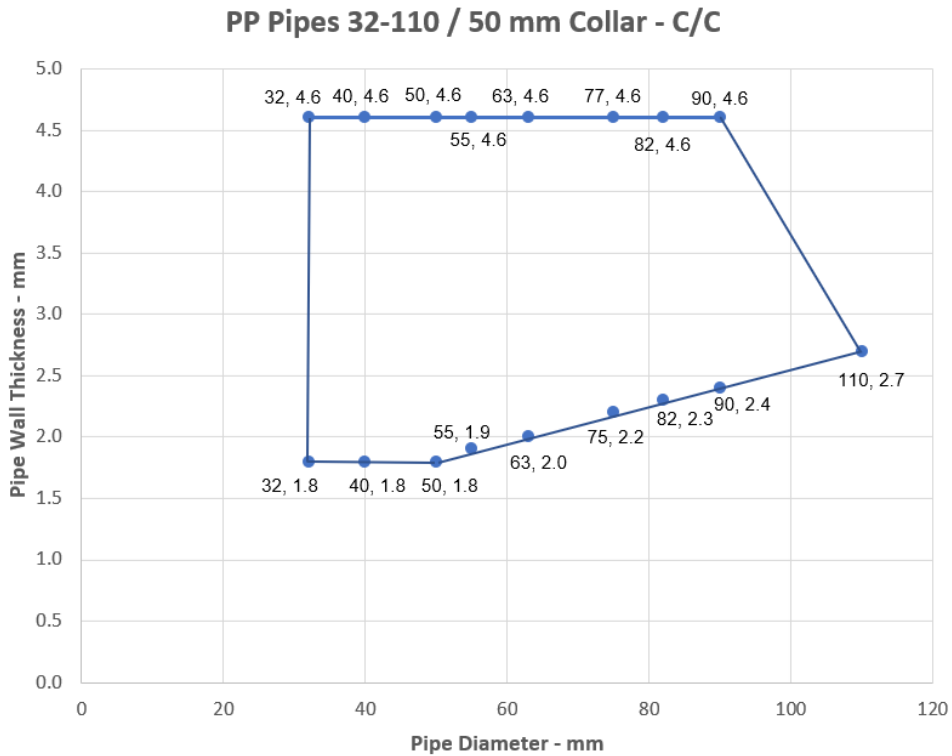

### PP Pipes 110-160 / 60 mm Collar - C/C

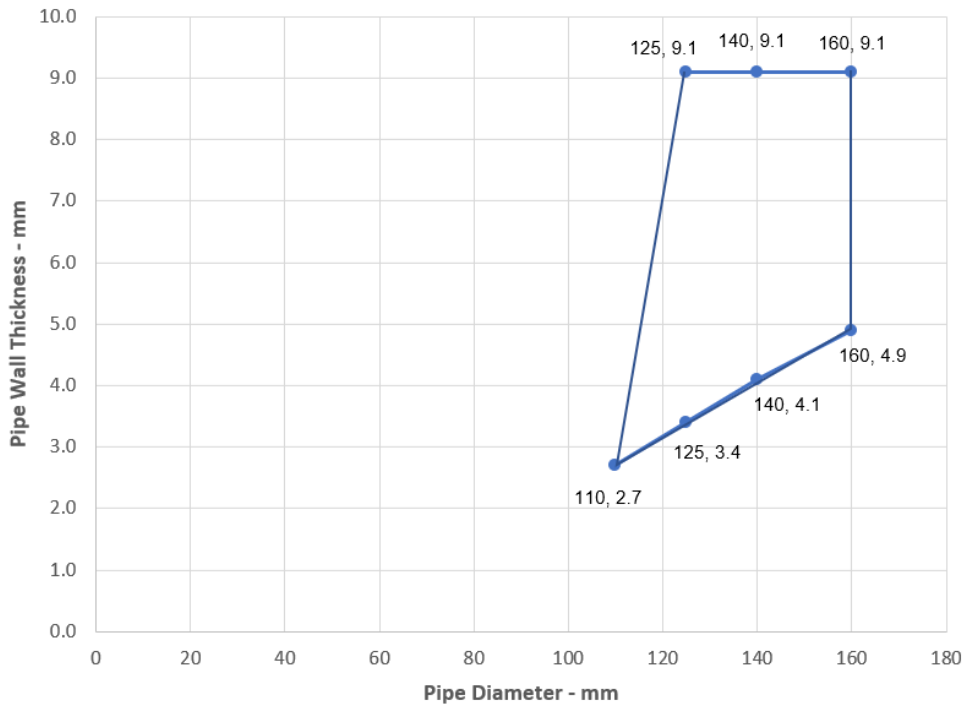

**A.6 Flexible or rigid wall constructions according to 2. 2) with wall thickness of minimum 120 mm**

**A.6.1 Plastic pipe penetration seal with 2x FPMF Board 2-S**

**Penetration Seal:** Pipes fitted at any position within the aperture, with 60 mm FPMF Board 2-S to both sides of the wall. Minimum 30 mm separation between pipes.

Construction details:

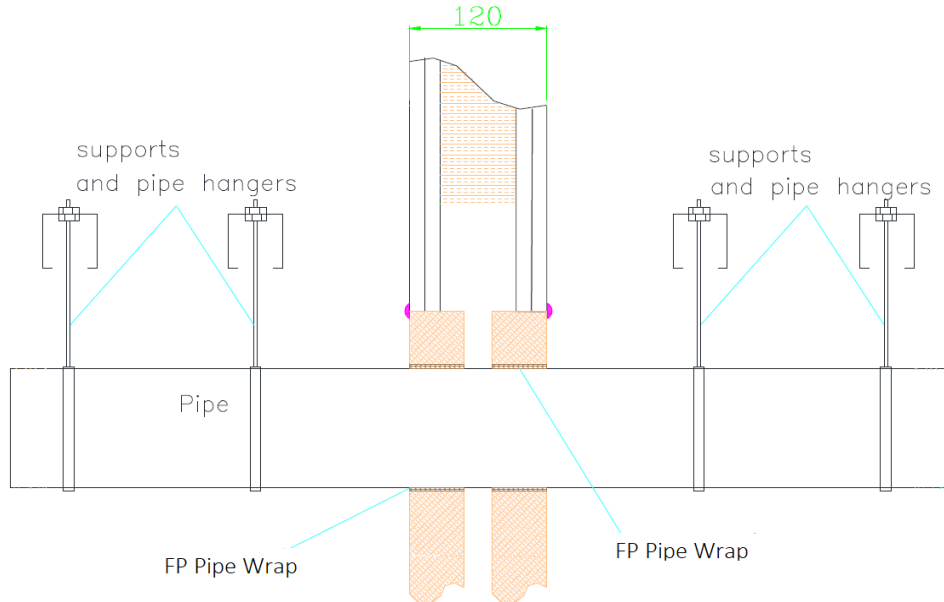

**A.6.1.1 Double side penetration seal with plastic pipes**

Services	Wraps (both sides)	Permitted configuration for seal separation	Classification
PVC-U pipe according to EN 1329-1, EN 1452-2 and EN 1453-1 and PVC-C according to EN 1566-1			
Diameter up to 40 mm, wall thickness 1.9-3.0 mm	50 x 3.6 mm (2 x 1.8 layer)	1 & 2	EI 120 C/C
Diameter up to 110 mm, wall thickness 2.7-6.6 mm	50 x 3.6 mm (2 x 1.8 layer)		
Diameter up to 160 mm, wall thickness 4.0-9.5 mm	50 x 10.8 mm (6 x 1.8 layer)		
PE pipe according to EN 1519-1, EN 12201-2 and EN 12006-1, ABS according to EN 1455-1 and pipes made from SAN+PVC according to EN 1565-1			
Diameter up to 40 mm, wall thickness 2.4-4.6 mm	50 x 1.8 mm (1 x 1.8 layer)	1 & 2	EI 120 C/C
Diameter up to 110 mm, wall thickness 3.4-10.0 mm	50 x 3.6 mm (2 x 1.8 layer)		
Diameter up to 160 mm, wall thickness 4.9-14.6 mm	50 x 10.8 mm (6 x 1.8 layer)		
PP pipe according to EN 1852-1: 2009			
Diameter up to 40 mm, wall thickness 1.8-5.5 mm	50 x 1.8 mm (1 x 1.8 layer)	1 & 2	EI 120 C/C
Diameter up to 110 mm, wall thickness 2.7-10.0 mm	50 x 3.6 mm (2 x 1.8 layer)		
Diameter up to 160 mm, wall thickness 4.9-14.6 mm	50 x 10.8 mm (6 x 1.8 layer)		

\*See below graph for interpolation pipe sizes

### PVC Pipes 40-160 - C/C

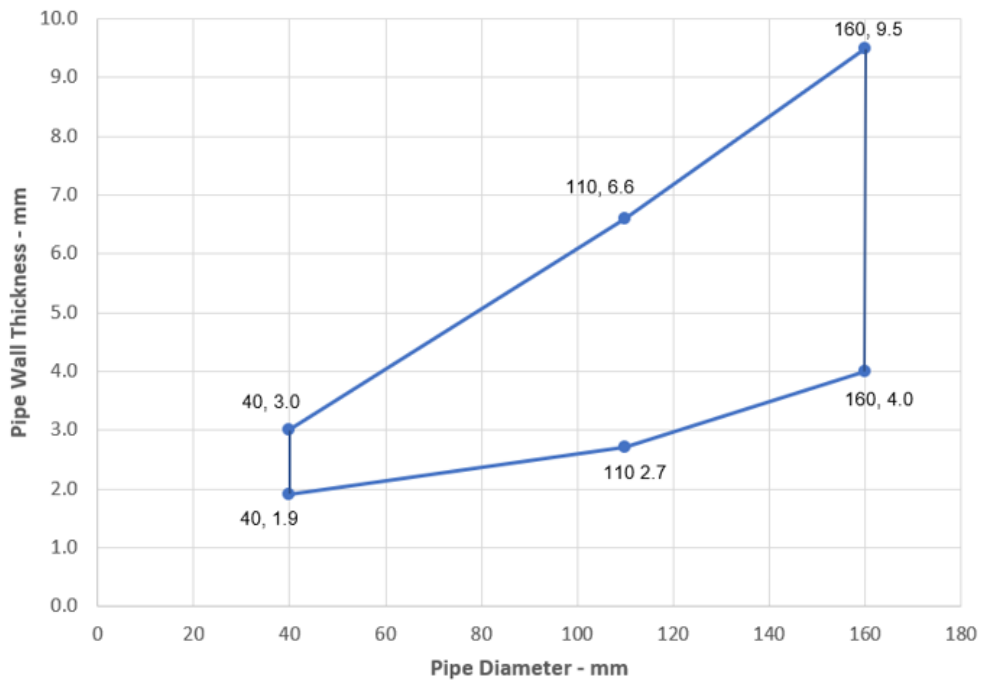

### PE Pipes 40-160 - C/C

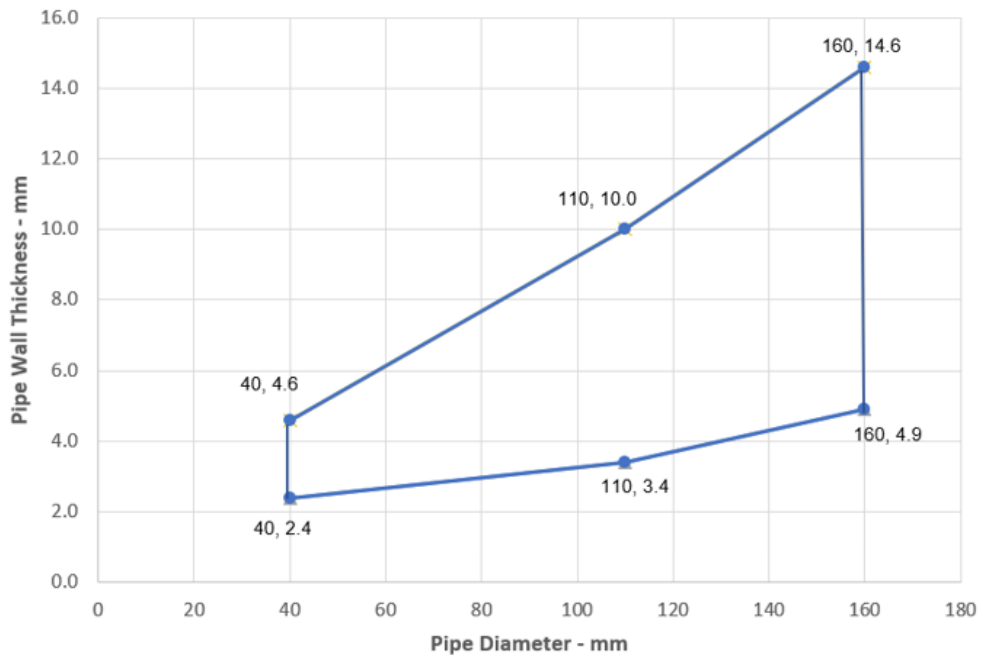

### PP Pipes 40-160 - C/C

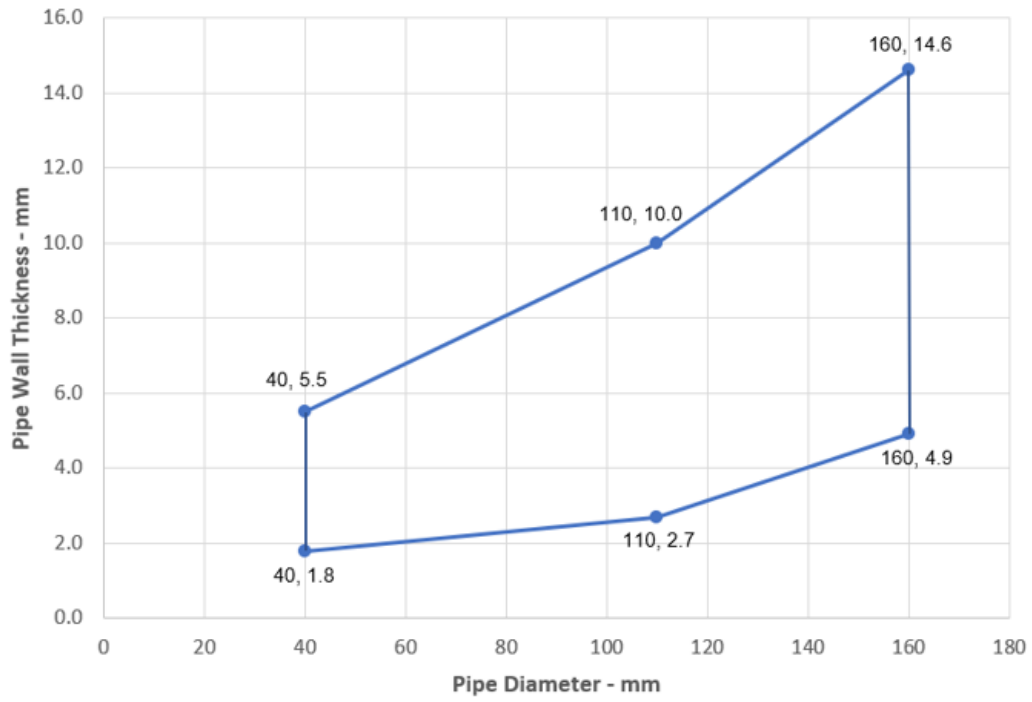

### A.6.2 Metallic pipe penetration seal with 2x FPMF Board 1-S

**Penetration Seal:** Metallic pipes fitted at any position within the aperture, with 50 mm FPMF Board 1-S to both sides of the wall. Minimum separation between penetration seals and seal edges of 30 mm. (Configuration 1 & 2).

Construction details:

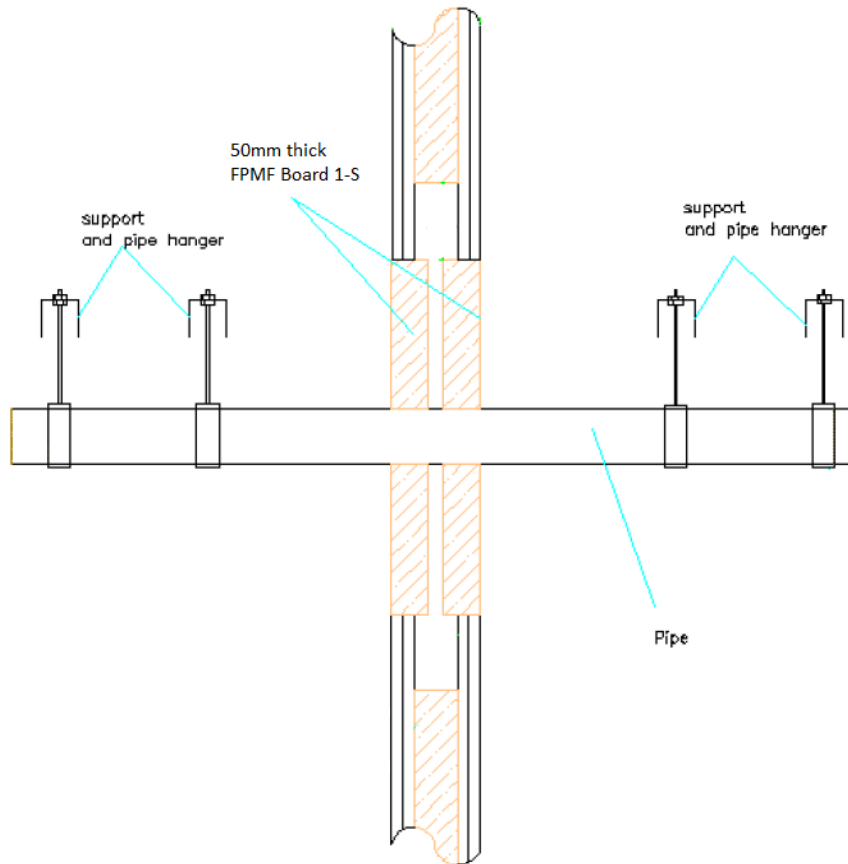

#### A.6.2.1 Double side penetration seal with metallic pipes

Services	Insulation	Permitted configuration for seal separation	Classification
Mild or stainless steel pipe	None	1 & 2	E 120 C/U, EI 30 C/U
Maximum 63 mm diameter *			
63-324 mm diameter*			E 120 C/U, EI 20 C/U
Copper, mild or stainless steel pipe			
12 mm diameter /0.7-6.0 mm wall thickness	None	1 & 2	E 120 C/C, EI 30 C/C
12-54 mm diameter *			E 120 C/C, EI 15 C/C
Alupex pipe			
Maximum 75 mm diameter*	None	1 & 2	E 120 C/C, EI 20 C/C

\*See below graph for interpolation pipe sizes



### Mild or Stainless Steel Pipes - E 120 C/U, EI 20 C/U

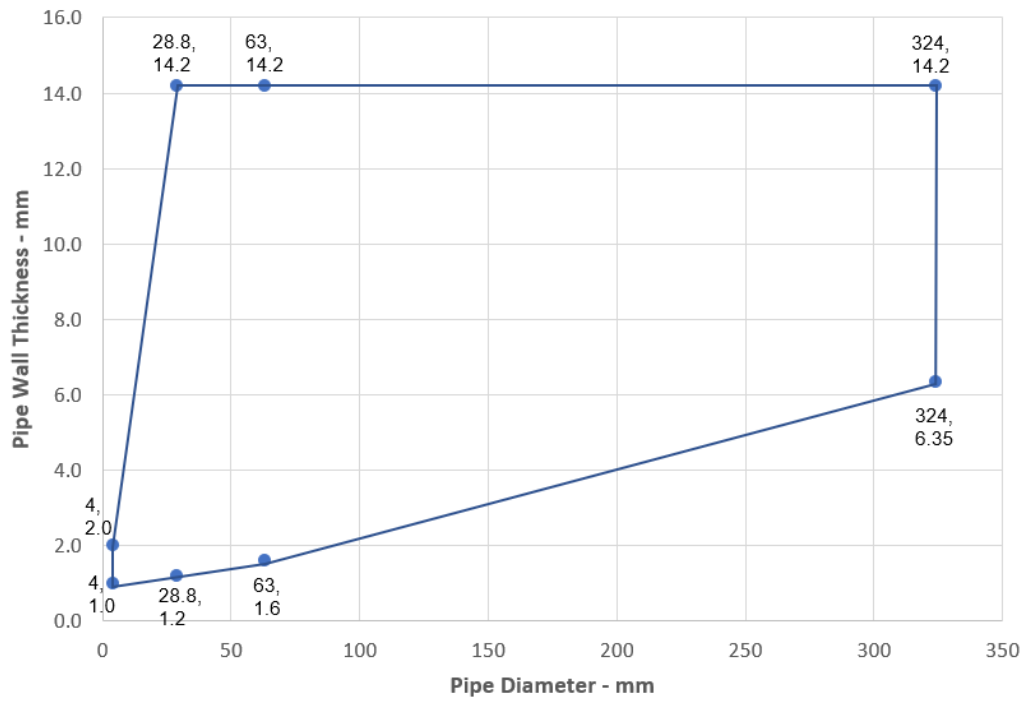

### Copper, mild or Stainless Steel Pipes - E 120 C/C, EI 15 C/C

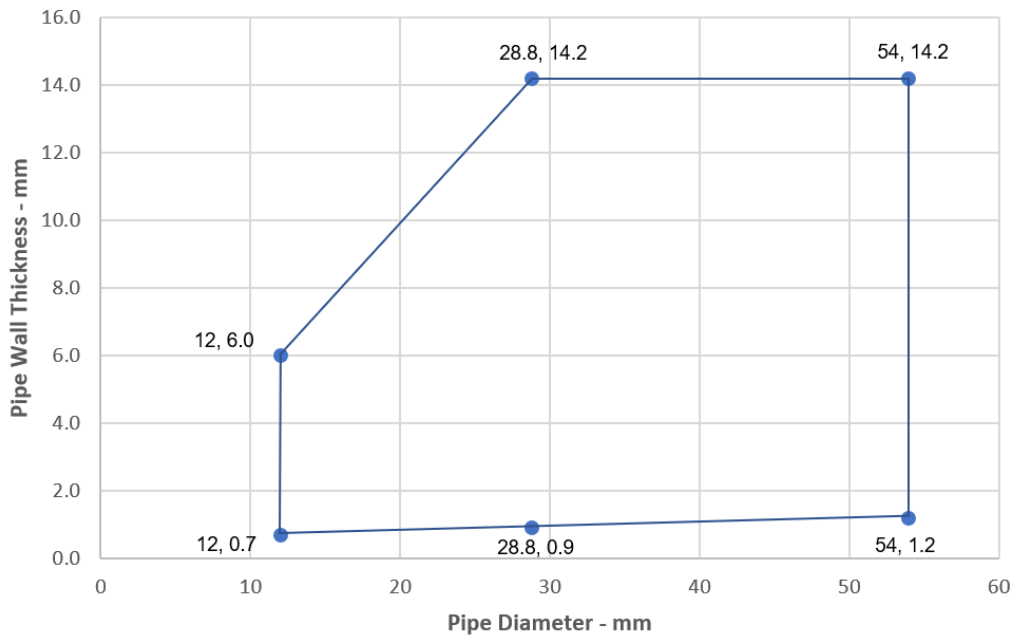

### Alupex Pipes - E 120 C/C, EI 20 C/C

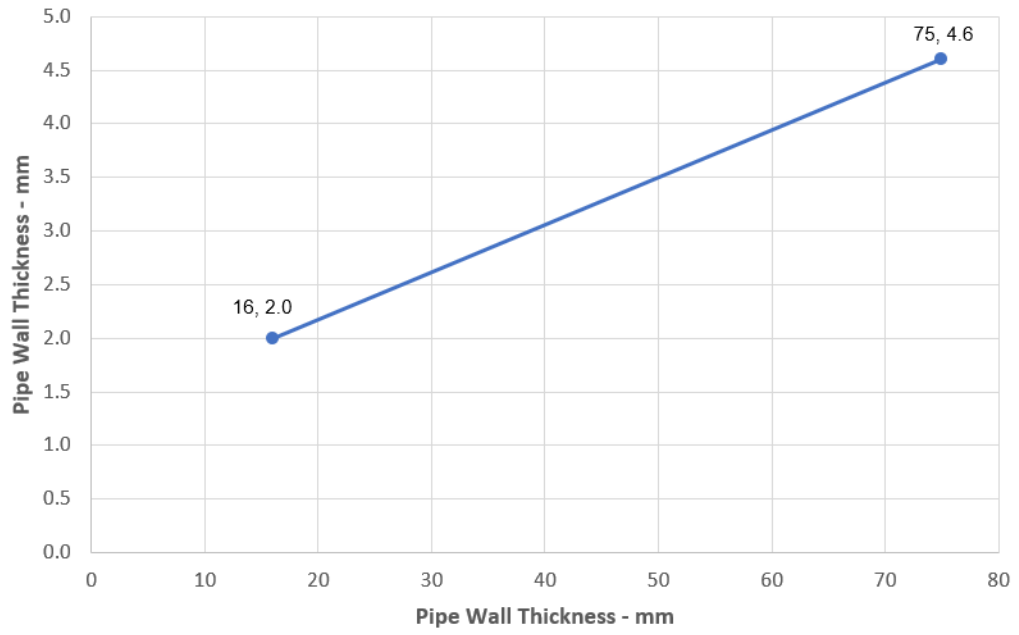

**A.7 Timber wall constructions according to 2. 2) with wall thickness of minimum 100 mm**

**A.7.1 FPMF Board 50 mm 1-S penetration seal (pattress) with cables**

**Penetration Seal:** Cables fitted at any position within the aperture, with 50 mm FPMF Board 1-S to both sides of the wall. Boards to be pattress fixed with 100 mm wood screws and penny washers at 300 mm centres and with a minimum 100 mm overlap around the opening.

Construction details:

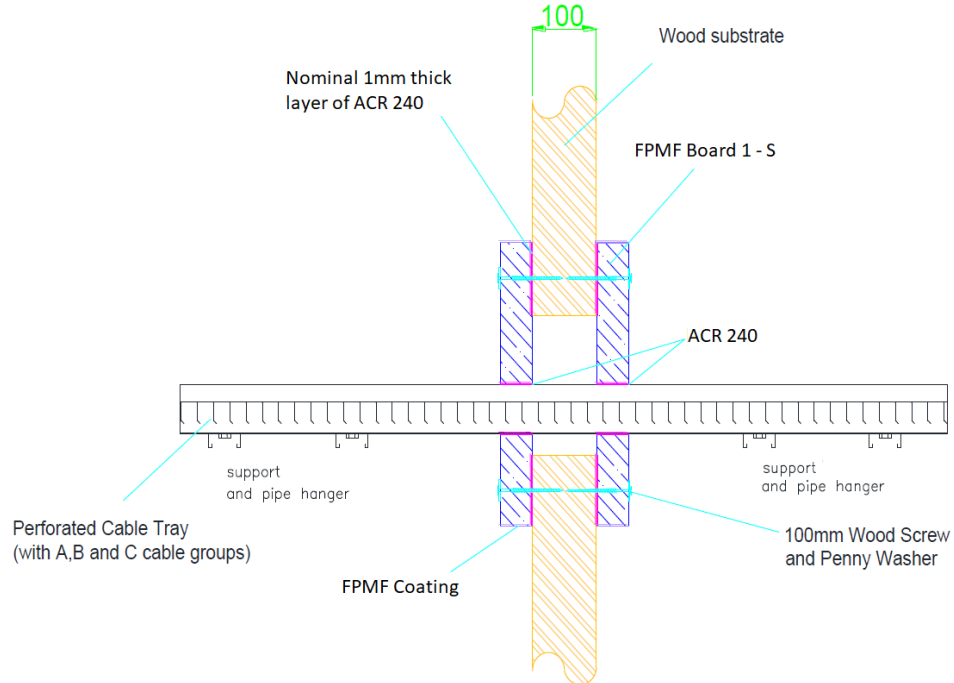

**A.7.1.1 Two side penetration seal with cables**

Services	Maximum aperture	Classification
Electrical cables up to 21 mm $\varnothing$ (single, bundled and on trays)	1200 mm x 600 mm	E 120, EI 90
Electrical cables up to 50 mm $\varnothing$ (single, bundled and on trays)		

## ANNEX B – Air Permeability – FPMF Board

Product tested	1200mm high x 600mm wide FPMF Board 50mm 2-S		
	Summary of testing procedure		Result
	Pressure (Pa)	Leakage (m <sup>3</sup> /h)	Leakage (m <sup>3</sup> /m <sup>2</sup> /h)
Results under negative chamber pressure	25	0.00	0.00
	50	0.01	0.01
	100	0.02	0.03
	200	0.04	0.06
	300	0.11	0.15
	450	0.49	0.68
	600	0.95	1.32
Results under positive chamber pressure	25	0.00	0.00
	50	0.01	0.01
	100	0.03	0.04
	200	0.08	0.11
	300	0.2	0.28
	450	0.63	0.88
	600	1.01	1.40

