

FDV-dokumentasjon

Produkt: 071402 18 064 1

TANG UTV.SEEGERRING 19-
60MM Ø:1,8 90`

Tenger for innvendige og utvendige seegerringer

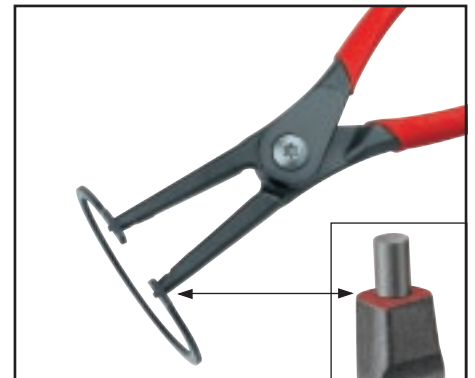
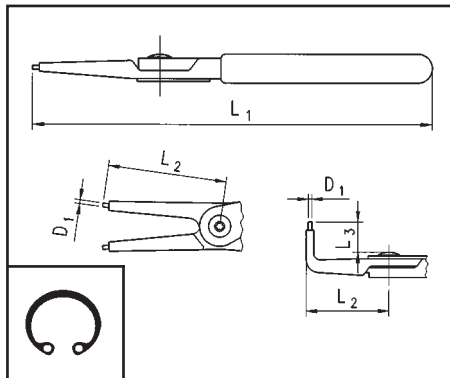

L1 mm	DIN 5256 Form		Ø mm	D ₁ mm	L ₂ mm	L ₃ mm	Art. nr.	
140	C	 Rett	8-13	0,9	39	-	0714 02 01	1
140			12-25	1,25	38	-	0714 02 02	
180			19-60	1,8	54	-	0714 02 03	
225			40-100	2,25	65	-	0714 02 04	
320			85-140	3,2	91	-	0714 02 05	
130	D	 ↙90°	8-13	0,9	26	12	0714 02 06	
130			12-25	1,25	26	12	0714 02 07	
165			19-60	1,8	40	14	0714 02 08	
210			40-100	2,25	49	16	0714 02 09	
305			85-140	3,2	73	20	0714 02 10	

God sidestøtte hindrer vridning av ringen ved utspenning

Tenger for innvendige seegerringer
Norm: DIN 5256

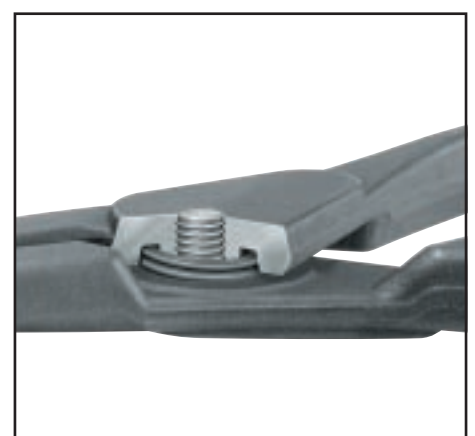
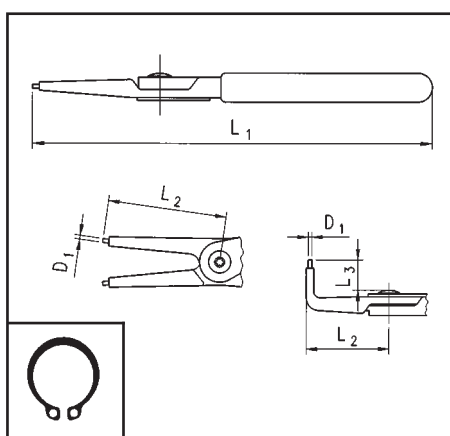
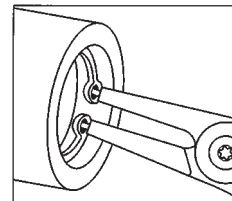

L1 mm	DIN 5256 Form		Ø mm	D ₁ mm	L ₂ mm	L ₃ mm	Art. nr.		
140	A	 Rett	3-10	0,9	39	-	0714 02 11	1	
140			10-25	1,25	38	-	0714 02 12		
180			19-60	1,8	56	-	0714 02 13		
225				40-100	2,25	70	-		0714 02 14
320			85-140	3,2	92	-	0714 02 15		
130	B	 ↙90°	3-10	0,9	27	12	0714 02 16		
130			10-25	1,25	27	12	0714 02 17		
165			19-60	1,8	40	15	0714 02 18		
210				40-100	2,25	55	16		0714 02 19
305			85-140	3,2	73	20	0714 02 20		

Integrert returfjær i leddet

Tenger for utvendige seegerringer
Norm: DIN 5254

