

FDV-dokumentasjon

Produkt: 071402 11 064 1

TANG UTV.SEEGERRING 3-
10MM Ø:0,9 RETT

Tenger for innvendige og utvendige seegerringer

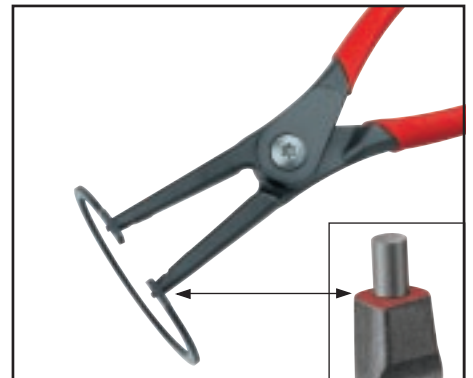
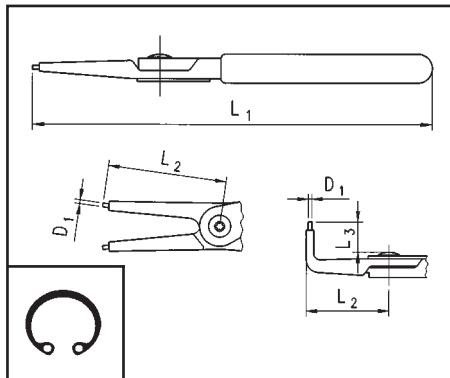

L1 mm	DIN 5256 Form	Ø mm	D ₁ mm	L ₂ mm	L ₃ mm	Art. nr.	
140	C Rett	8-13	0,9	39	-	0714 02 01	1
140		12-25	1,25	38	-	0714 02 02	
180		19-60	1,8	54	-	0714 02 03	
225		40-100	2,25	65	-	0714 02 04	
320		85-140	3,2	91	-	0714 02 05	
130	D ↙90°	8-13	0,9	26	12	0714 02 06	
130		12-25	1,25	26	12	0714 02 07	
165		19-60	1,8	40	14	0714 02 08	
210		40-100	2,25	49	16	0714 02 09	
305		85-140	3,2	73	20	0714 02 10	

God sidestøtte hindrer vridning av ringen ved utspenning

Tenger for innvendige seegerringer
Norm: DIN 5256

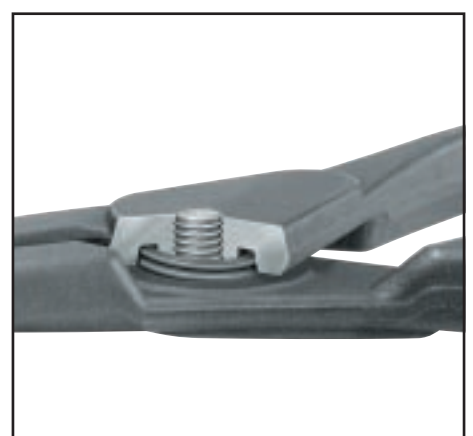
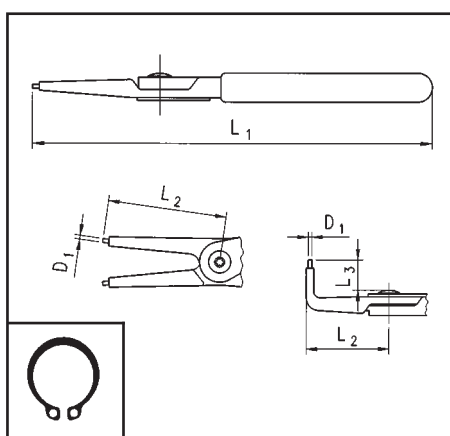
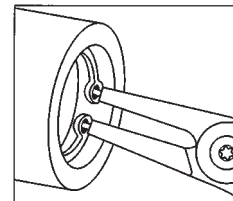

L1 mm	DIN 5256 Form	Ø mm	D ₁ mm	L ₂ mm	L ₃ mm	Art. nr.	
140	A Rett	3-10	0,9	39	-	0714 02 11	1
140		10-25	1,25	38	-	0714 02 12	
180		19-60	1,8	56	-	0714 02 13	
225		40-100	2,25	70	-	0714 02 14	
320		85-140	3,2	92	-	0714 02 15	
130	B ↙90°	3-10	0,9	27	12	0714 02 16	
130		10-25	1,25	27	12	0714 02 17	
165		19-60	1,8	40	15	0714 02 18	
210		40-100	2,25	55	16	0714 02 19	
305		85-140	3,2	73	20	0714 02 20	

Integrert returfjær i leddet

Tenger for utvendige seegerringer
Norm: DIN 5254

