



Paslode®

DFSN90.1

DFSN100.1

DFSN90.1-17



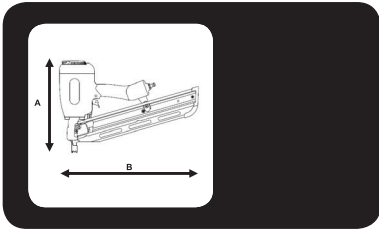

DFSN90.1

		<p>A = 343 mm B = 521 mm C = 115 mm</p>

<p>Min. 4,9 bar Max. 8,3 bar</p>	<p>2,9l (6 bar) / </p>	<p>Ps max. = 8,3 bar</p>
--------------------------------------	------------------------	--------------------------

<p>EN 12549+EN ISO 4871</p>	<p>L_{wA,1s} = 102 dBA L_{pA,1s} = 92 dBA L_{pA,1s,1m} = 89 dBA</p>
<p>EN12096 : 1997</p> <p>ISO 8662 - 11</p>	<p>Vibration = 3,3 m/s²</p>

<p>Min. 61 x</p>		
------------------	--	--

PASLODE 21° COLLATED STRIP NAILS

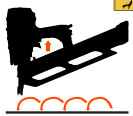

	<p>Sequential trigger actuation/ Einzelauslösung/ enkelschots/ Déclenchement du tir - mode séquentiel/ Funcionamiento secuencial "en continuo"/ Gatilho de actuação sequencial/ funzionamento sequenziale (colpo a colpo)/ Enkeltskuds aftrækker/ Enkeltskott/ Enkeltskudds avtrekker/ Kertalaukaisu/ Üksiklasu meetodil töötamine/ Uruchomienie spustu sekwencyjne/ Sekvenčni spoušť/ Egyes lövés (szakaszosan működtetett elsütő billentyűvel)/ Posamezno proženje/ Kontaktirajte singl / Последовательная активация при нажатии на курок/ Sekvenčná aktivácia spúšte/ التشغيل بالزر التسلسلي المقيد / Nuoseklusis paleidimo mechanizmas/ Sekvenciālās palaišanas iedarbināšana Raðkveikjuvirkjun</p>
	<p>Contact trigger actuation/ Kontaktauslösung/ repetierend schießen/ Déclenchement du tir - mode rafale/ Funcionamiento por contacto "clavo a clavo"/ Gatilho de actuação por contacto/ funcionamento a contacto/ Stødsdydnings aftrækker/ Støtskjutning/ Støtspikrings avtrekker/ Kosketuslaukaisu/ Automaatmeetodil töötamine/ Uruchomienie spustu przez kontakt/ Kontaktní spoušť/ Sorozatlövés (folyamatosan behúzott elsütő billentyűvel)/ Kontaktno proženje/ Kontaktirajte pokretanje/ Контактная активация при нажатии на курок/ Kontaktná aktivácia spúšte/ التشغيل بتلامس الزر / Kontaktinis paleidimo mechanizmas/ Kontakta palaišanas iedarbināšana/ Snertikveikjuvirkjun</p>

Model: DFSN90.1 Sequential
No. 505273











DFSN90.1
Pneumatic strip nailer
for 21° plastic collated nails
Code: 505273
Trigger actuation: Sequential

Nail diameter: 2.8-3.1 mm
Nail length: 50-90 mm

ITW Befestigungssysteme GmbH, Carl-Zeiss-Str. 19 - 30968 Hemmingen, Germany



				 <p>3x</p>
<p>No. 014748 + No. 576668</p>		<p>No. 014121</p>		

Accessories



No. 151299 / No. 576216
0,5l oil / 1 l oil

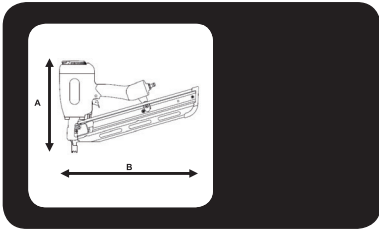

DFSN100.1

		<p>A = 360 mm B = 515 mm C = 115 mm</p>
		<p>= 3,6 kg</p>

<p>2,9l (6 bar) / </p>
<p>Ps max. = 8,3 bar</p>

<p>EN 12549+EN ISO 4871</p>	<p>L_{wA}, 1s = 103 dBA L_{pA}, 1s = 94 dBA L_{pA}, 1s, 1m = 90 dBA</p>
<p>EN 12096 : 1997 ISO 8662-11</p>	<p>Vibration = 3,8 m/s²</p>

<p>Min. 66 x </p>		
<p>PASLODE 21° COLLATED STRIP NAILS</p>		<p>d max= 3,4 mm L= 50 - 100 mm</p>



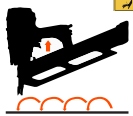



	<p>Sequential trigger actuation/ Einzelauslösung/ enkelschots/ Déclenchement du tir - mode séquentiel/ Funcionamiento secuencial "en continuo"/ Gatilho de actuação sequencial/ funzionamento sequenziale (colpo a colpo)/ Enkeltskuds aftrækker/ Enkelskott/ Enkeltskudds avtrekker/ Kertalaukaisu/ Üksiklasu meetodil töötamine/ Uruchromienie spustu sekwencyjne/ Sekvenčni poušt/ Egyes lövés (szakaszosan működtetett elsütő billentyűvel)/ Posamezno proženje/ Kontaktirajte singl / Последовательная активация при нажатии на курок/ Sekvenčná aktivácia spúšte/ التشغيل بالتسلسل(المقيد) / Nuoseklusis paleidimo mechanizmas/ Sekvenciālās palaišanas iedarbināšana Raðkveikjuvirkjun</p>
	<p>Contact trigger actuation/ Kontaktauslösung/ repetierend schießen/ Déclenchement du tir - mode rafale/ Funcionamiento por contacto "clavo a clavo"/ Gatilho de actuação por contacto/ funcionamento a contacto/ Stødskydnings aftrækker/ Støtskjutning/ Støtspikrings avtrekker/ Kosketuslaukaisu/ Automaatmeetodil töötamine/ Uruchromienie spustu przez kontakt/ Kontaktní poušt/ Sorozatlövés (folyamatosan behúzott elsütő billentyűvel)/ Kontaktno proženje/ Kontaktirajte pokretanje/ Контактная активация при нажатии на курок/ Kontaktná aktivácia spúšte/ التشغيل بتلامس الزر / Kontaktinis paleidimo mechanizmas/ Kontakta palaišanas iedarbināšana/ Snertikveikjuvirkjun</p>





Model: DFSN100.1 Sequential

No. 505275





<p>Pastolde DFSN100.1 Pneumatic strip nailer for 21° plastic collated nails Code: 505275 Trigger actuation: Sequential</p>	 <p>Nail diameter: 2.8 – 3.4 mm Nail length: 50– 100 mm</p> <p>CE    </p> <p><small>(TW) Befestigungssysteme GmbH, Carl-Zoschke-Str. 19 • 33968 Hemmingen, Germany</small></p>
---	---



				 3x
<p>No. 014748 + No. 576668</p>		<p>No 014121</p>		

Accessories

	
<p>No. 151299 / No. 576216</p>	
<p>0,5l oil / 1 l oil</p>	

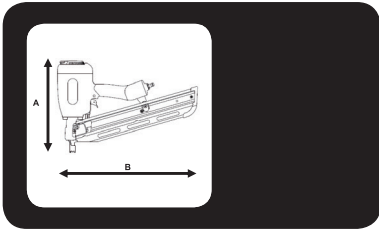

DFSN90.1-17

		<p>A = 343 mm B = 521 mm C = 115 mm</p>
		<p>kg = 3,5 kg</p>

<p>2,9l (6 bar) / </p>
<p>Ps max. = 8,3 bar</p>

<p>EN 12549+EN ISO 4871</p>	<p>L_{WA.1s} = 102 dBA L_{pA.1s} = 92 dBA L_{pA.1s1m} = 89 dBA</p>
<p>EN 12096 : 1997 ISO 8662-11</p>	<p>Vibration = 3,75 m/s²</p>

<p>Min. 61 x = </p>		
<p>PASLODE 17° COLLATED STRIP NAILS</p>		<p>d max= 3,1 mm L= 50 - 90 mm</p>



	<p>Sequential trigger actuation/ Einzelauslösung/ enklshots/ Déclenchement du tir - mode séquentiel/ Funcionamiento secuencial "en continuo"/ Gatilho de actuação sequencial/ funzionamento sequenziale (colpo a colpo)/ Enkeltskuds aftrækker/ Enkeltskott/ Enkeltskudds avtrekker/ Kertalaukaisu/ Üksiklasu meetodil töötamine/ Uruchomienie spustu sekwencyjne/ Sekvenčni spoušť/ Egyes lövés (szakaszosan működtetett elsütő billentyűvel)/ Posamezno proženje/ Kontaktirajte singl / Последовательная активация при нажатии на курок/ Sekvenčná aktivácia spúšte/ التشغيل بالزر التسلسلي المقفود / Nuoseklusis paleidimo mechanizmas/ Sekvenciālās palaišanas iedarbināšana Raðkveikjuvirkjun</p>
	<p>Contact trigger actuation/ Kontaktauslösung/ repeterend schieten/ Déclenchement du tir - mode rafale/ Funcionamiento por contacto "clavo a clavo"/ Gatilho de actuação por contacto/ funcionamento a contatto/ Stødskydnings aftrækker/ Støtskjutning/ Støtspikrings avtrekker/ Kosketuslaukaisu/ Automaatmeetodil töötamine/ Uruchomienie spustu przez kontakt/ Kontaktní spoušť/ Sorozatlövés (folyamatosan behúzott elsütő billentyűvel)/ Kontaktno proženje/ Kontaktirajte pokretanje/ Контактная активация при нажатии на курок/ Kontaktná aktivácia spúšte/ التشغيل بالزر / Kontaktinis paleidimo mechanizmas/ Kontakta palaišanas iedarbināšana/ Snertikveikjuvirkjun</p>

Model: DFSN90.1-17 Sequential

No. 505943



<p>Paslode DFSN90.1-17 Pneumatic strip nailer for 17° plastic collated nails Code: 505943 Trigger actuation: Sequential</p>		<p>Nail diameter: 2.8 - 3.1 mm Nail length: 50 - 90 mm</p>	
---	--	--	--



No. 014748 + No. 576668



No 014121



3x

Accessories



No. 151299 / No. 576216

0,5l oil / 1 l oil

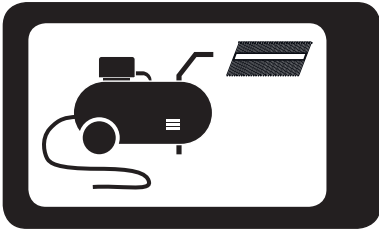

014 748

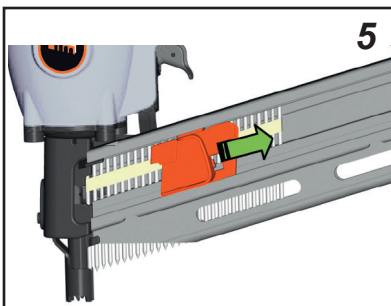
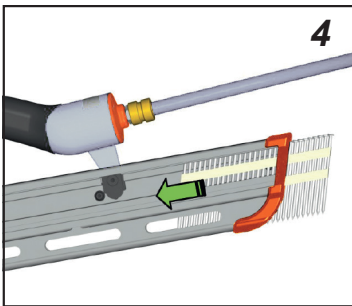
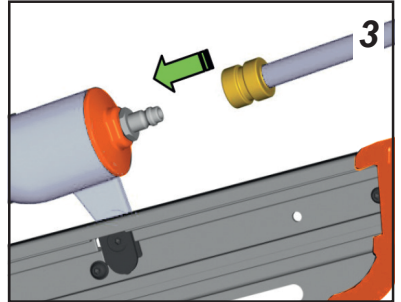
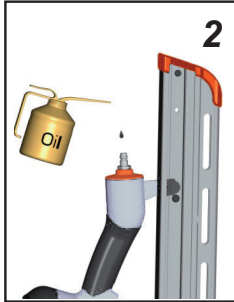
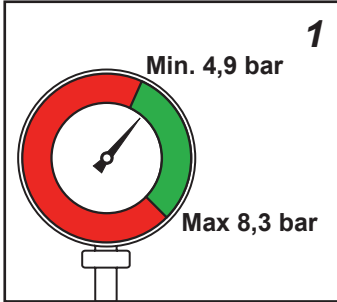

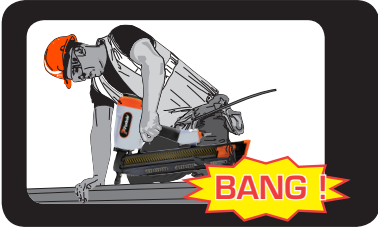

014 748

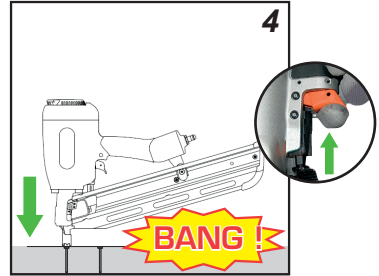
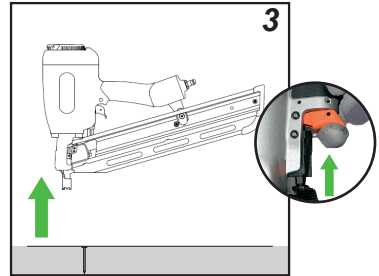
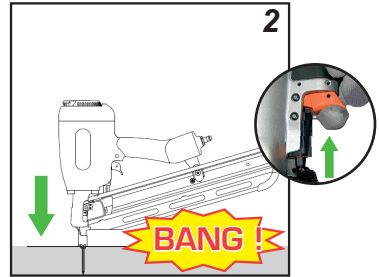
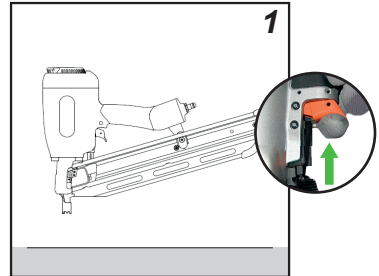
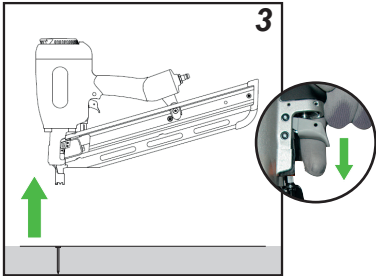
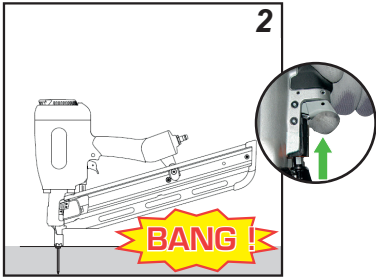
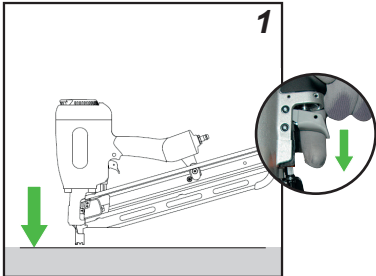
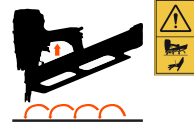

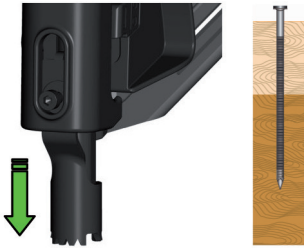
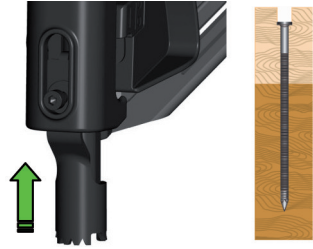
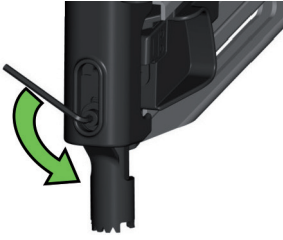
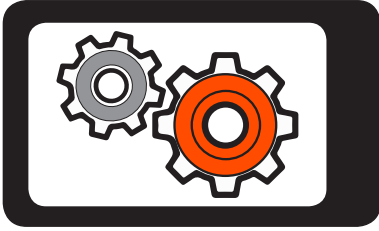

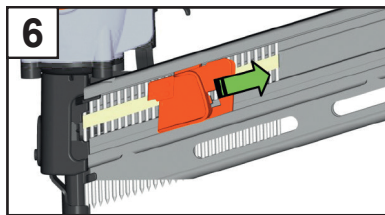
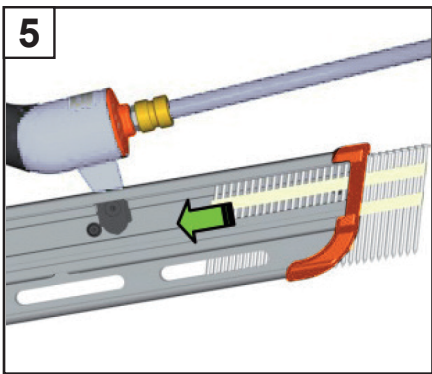
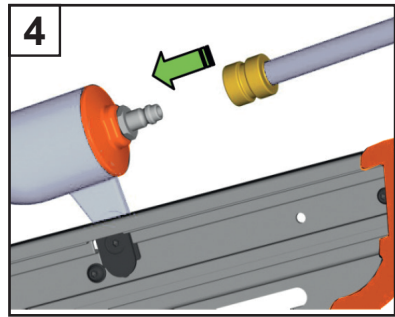
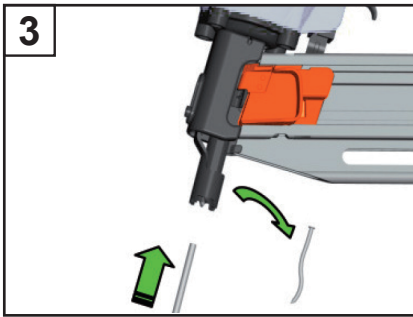
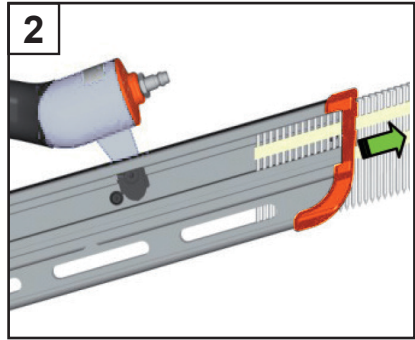
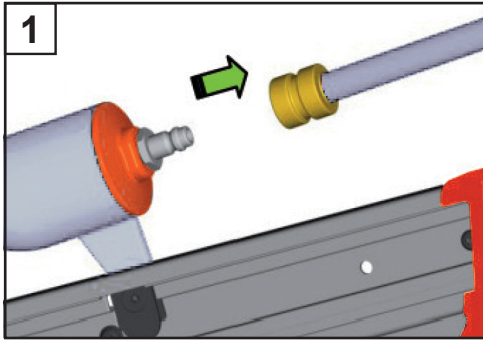
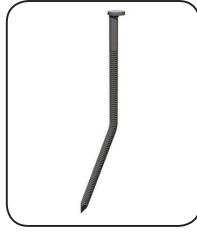
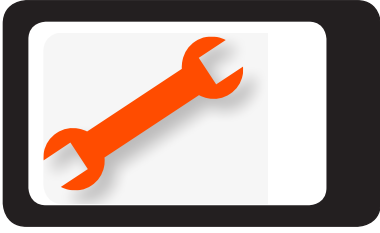

YY/WW....



YY= Year of manufacture
WW = Week of manufacture

**Resting position/ Ruheposition/ Position de repos/ Ruststand/
Posición de descanso/ Posizione di riposo/ Posição de des-
canso/ Pozycja spoczynku/ Klidová poloha/ Nyugalmi állapot/
Положение в нерабочем состоянии/ Θέση αδράνειας/ Hvile-
stilling/ Viloläge/ Hvileposisjon/ Lepoasento/ Položaj mirovanja/
Pokojuvá poloha/ Položaj mirovanja/ وضع السكون / Ramybės
padėtis/ Ooteasend/ Miera stāvoklis/ Hvíldarstaða**





ITW CONSTRUCTION PRODUCTS EUROPE
Code 576668 (05/2019)
www.spitpaslode.com