

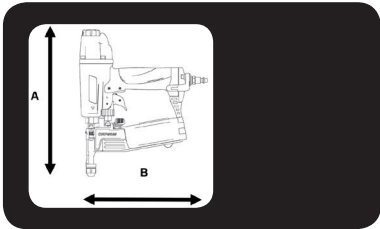

**Paslode**<sup>®</sup>

**CNP40M**

















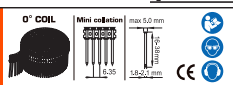

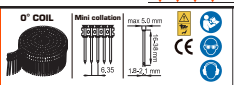
		<b>A = 285 mm</b> <b>B = 248 mm</b> <b>C = 111 mm</b>
		<b>kg = 1,26 kg</b>



<p>Min. 5,5 bar Max 8,3 bar</p>	<p>EN 12549+EN ISO 4871 EN12096 : 1997</p>	<b>L WA.1s = 89 dBA</b> <b>L pA.1s = 99 dBA</b> <b>L pA.1s1m = 76 dBA</b>
<p>1,1l (6,4 bar) / </p> <p><b>Ps max. = 8,3 bar</b></p>	<p>ISO 8662-11</p>	<b>Vibration = 2.1 m/s<sup>2</sup></b>

<p>325 x = </p>		
<p><b>Paslode 0° Coil Nails</b></p>	<p><b>Paslode Mini collation (IN)</b></p>	<p><b>D max. = 5 mm</b>  <b>L = 16-38 mm</b>  <b>d = 1,8-2,1 mm</b></p>



	<p>Sequential trigger actuation/ Einzelauslösung/ enkelschots/ Déclenchement du tir - mode séquentiel/ Funcionamiento secuencial "en continuo"/ Gatilho de actuação sequencial/ funzionamento sequenziale (colpo a colpo)/ Enkeltskuds aftrækker/ Enkelskott/ Enkeltskudds avtrekker/ Kertalaukaisu/ Üksiklasu meetodil töötamine/ Uruchromienie spustu sekwencyjne/ Sekvenčni spoušt/ Egyes lövés (szakaszosan működtetett elsütő billentyűvel)/ Posamezno proženje/ Kontaktirajte singl / Последовательная активация при нажатии на курок/ Sekvenčná aktivácia spúšte/ التشغيل بالزر التسلسلي المقيد / Nuoseklusis paleidimo mechanizmas/ Sekvenciālās palaišanas iedarbināšana Raðkveikjvirkjun</p>				
	<p>Contact trigger actuation/ Kontaktauslösung/ repeterend schieten/ Déclenchement du tir - mode rafale/ Funcionamiento por contacto "clavo a clavo"/ Gatilho de actuação por contacto/ funzionamento a contatto/ Stødskydning aftrækker/ Støtskjutning/ Støtspikrings avtrekker/ Kosketuslaukaisu/ Automaattimeetodil töötamine/ Uruchromienie spustu przez kontakt/ Kontaktní spoušt/ Sorozatlövés (folyamatosan behűzött elsütő billentyűvel)/ Kontaktno proženje/ Kontaktirajte pokretanje/ Контактная активация при нажатии на курок/ Kontaktná aktivácia spúšte/ التشغيل بتلامس الزر / Kontaktinis paleidimo mechanizmas/ Kontakta palaišanas iedarbināšana/ Snertikveikjvirkjun</p>				
<p><b>Model: CNP40M</b> <b>No. 575780</b></p> 	<p><b>Model: CNP40M</b> <b>No. 575781</b></p> 				
 	 				
					
					 <p>3x</p>
<p>No. 014748 + No. 576669</p>	<p>No. 617617</p>	<p>No. 014121</p>			

Accessories

	
<p>No. 617624 Magazine insert</p>	<p>No. 151299 / No. 576216 0,5 l oil / 1 l oil</p>



014 748

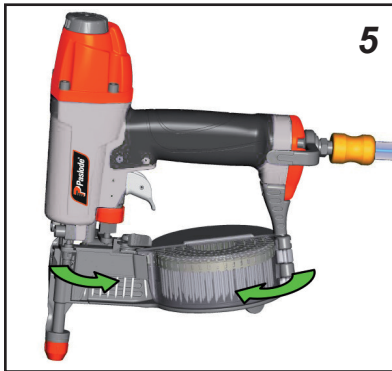
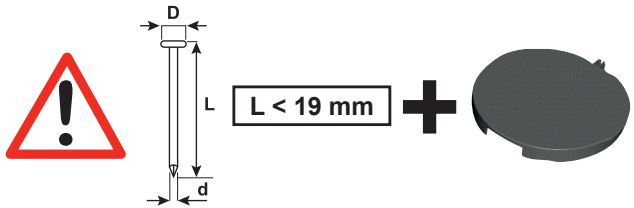
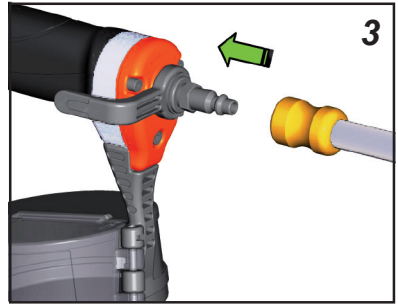
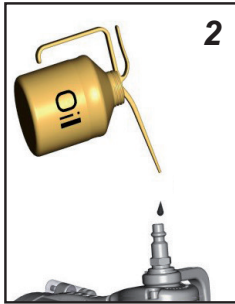
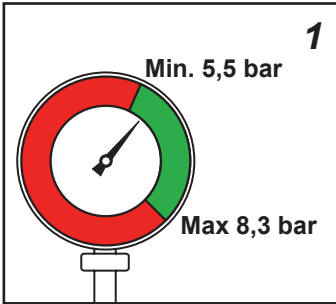



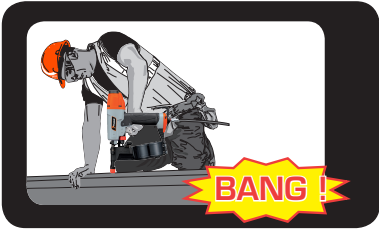

014 748

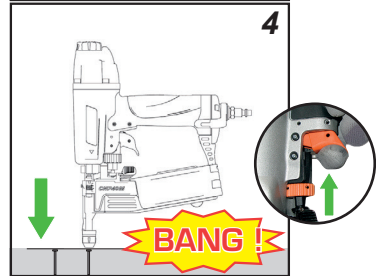
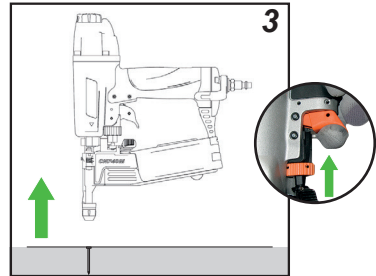
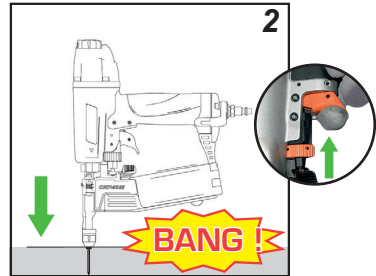
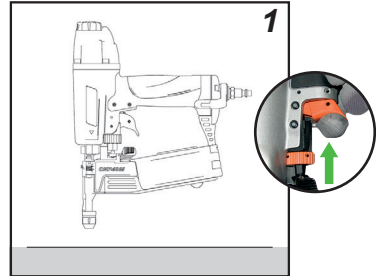
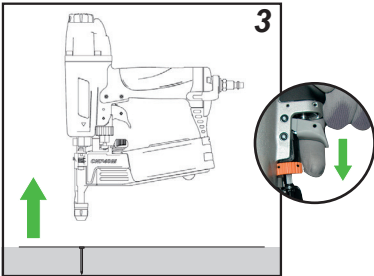
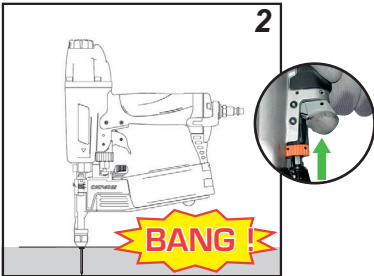
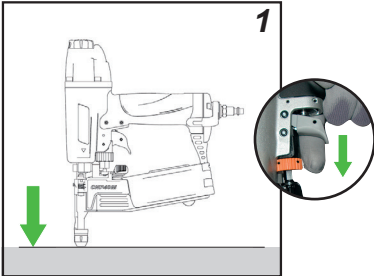

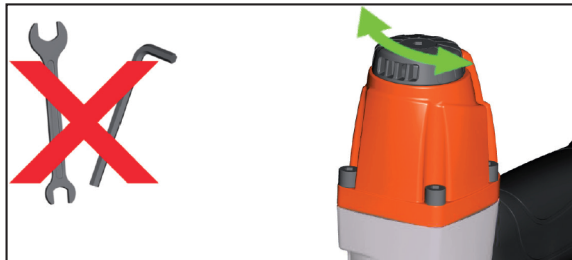
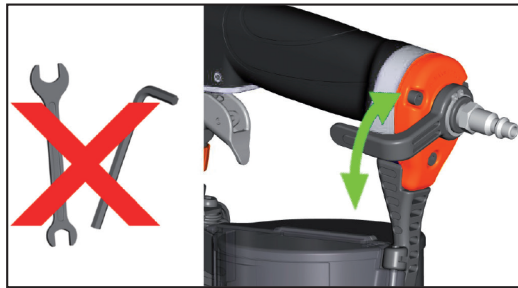
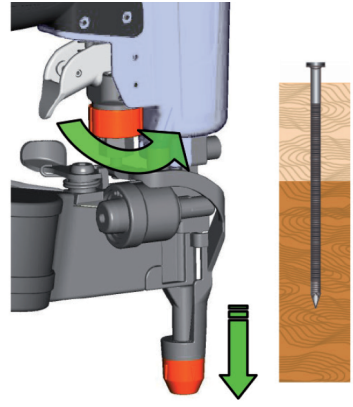
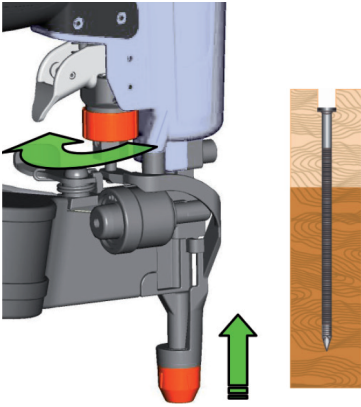
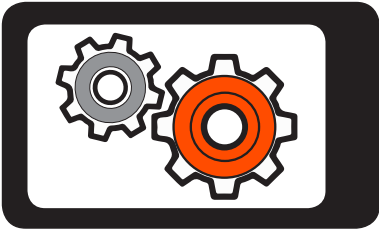

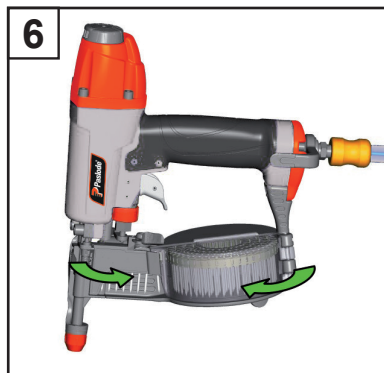
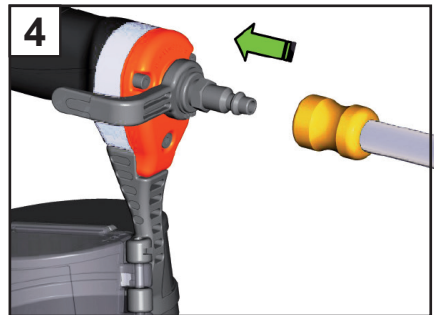
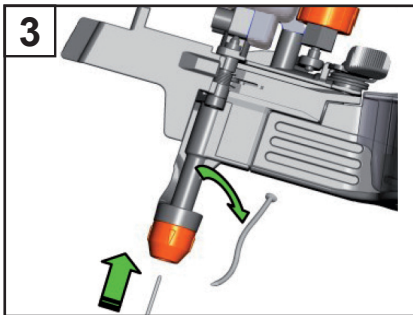
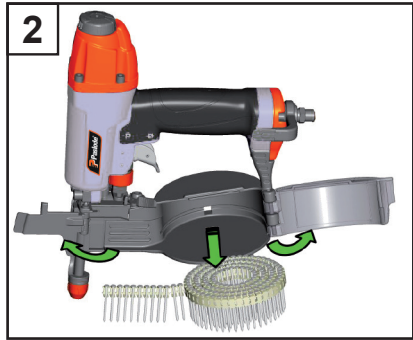
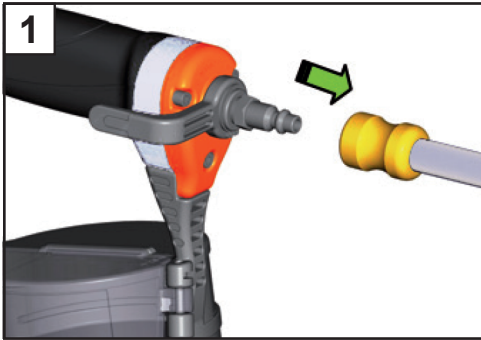
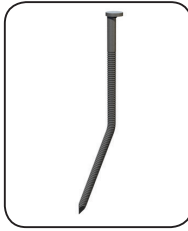
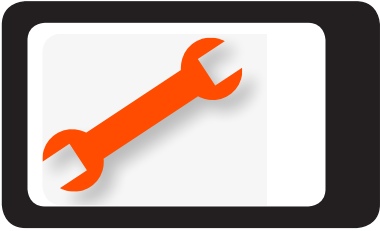



YY/WW....

YY= Year of manufacture  
WW = Week of manufacture

**Resting position/ Ruheposition/ Position de repos/ Ruststand/  
Posición de descanso/ Posizione di riposo/ Posição de des-  
canso/ Pozycja spoczynku/ Klidová poloha/ Nyugalmi állapot/  
Положение в нерабочем состоянии/ Θέση αδράνειας/ Hviles-  
tilling/ Viloläge/ Hvileposisjon/ Lepoasento/ Položaj mirovanja/  
Pokoiová poloha/ Položaj mirovanja/ وضع السكون / Ramybės  
padėtis/ Ooteasend/ Miera stāvoklis/ Hvíldarstaða**





ITW CONSTRUCTION PRODUCTS EUROPE  
Code 576669 (04/2019)  
[www.spitpaslode.com](http://www.spitpaslode.com)