



**SPIT**

**P800**  
**PULSA**



---

**CE**

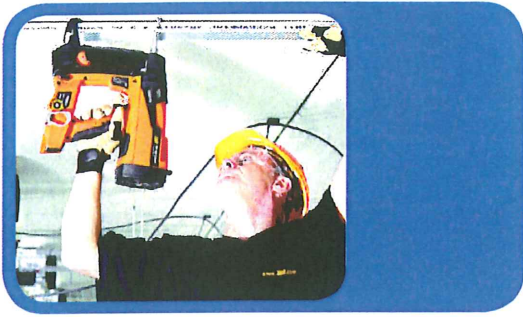

1



> 500



**Spilt P800 PULSA**

3

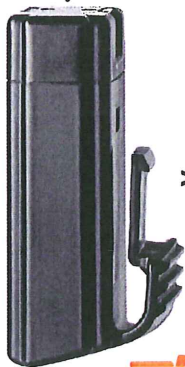

> 1500



**Spilt P800 PULSA**

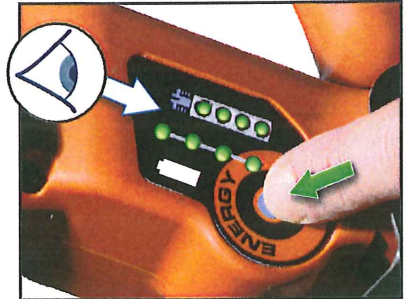
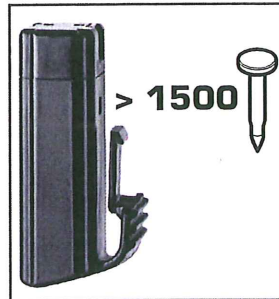
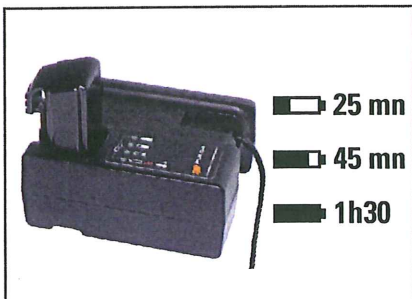

2

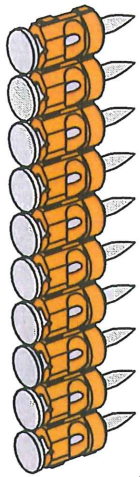

**SPIT P800**  
PULSA

L 15 ▶ 40 mm

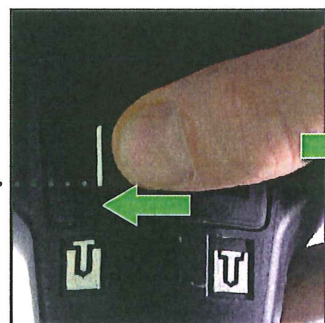
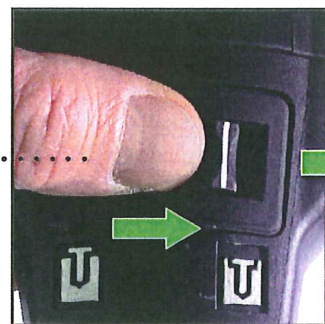
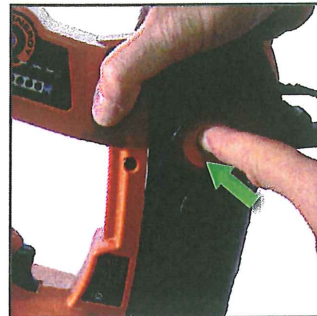
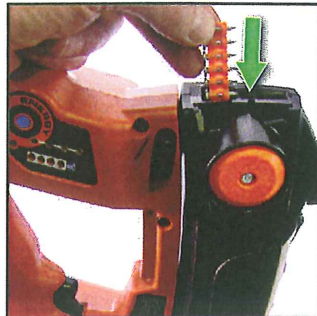
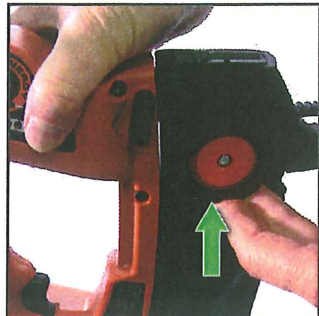

4

- 15 °C → + 49 °C



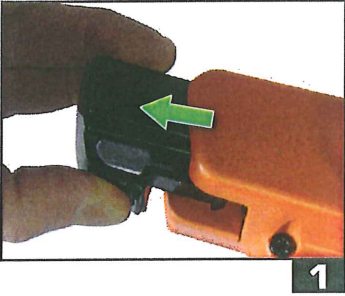

1

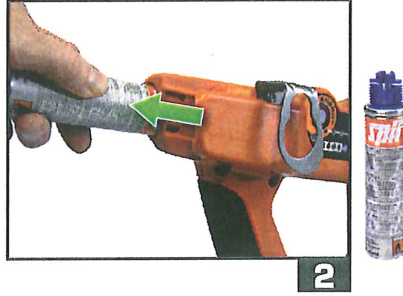

2

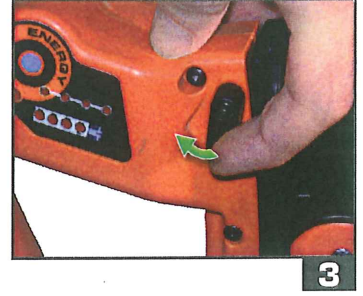

3



4

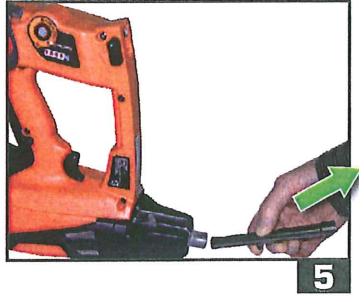

5



6



7

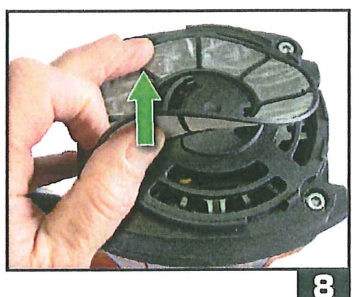

8

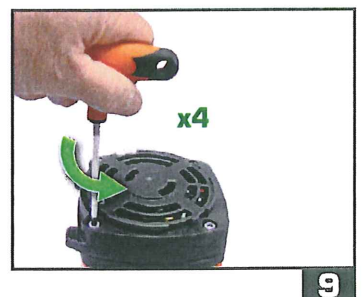

9

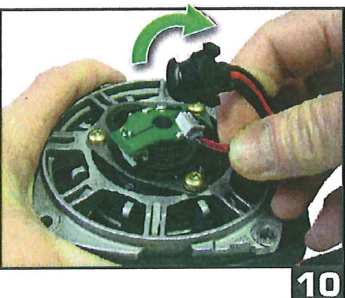

10



11

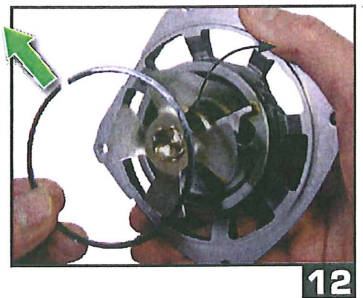

12

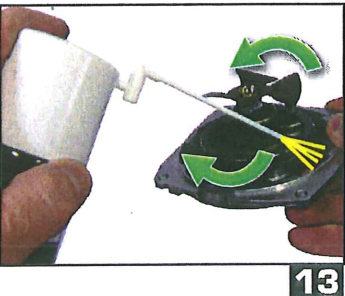

13



14

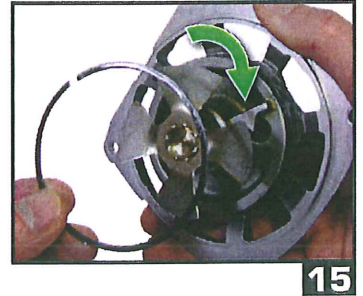

15

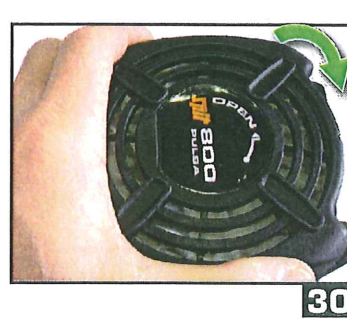
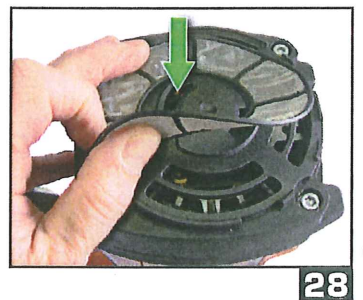
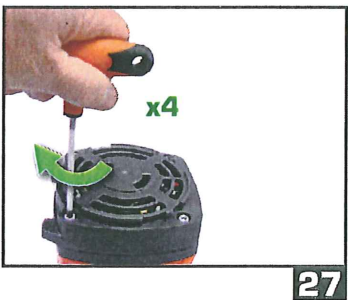
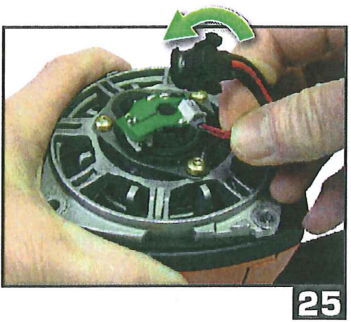
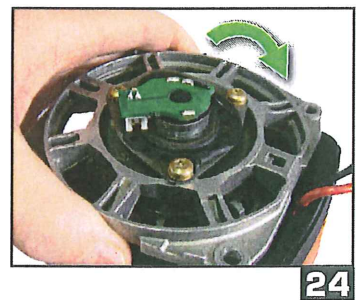
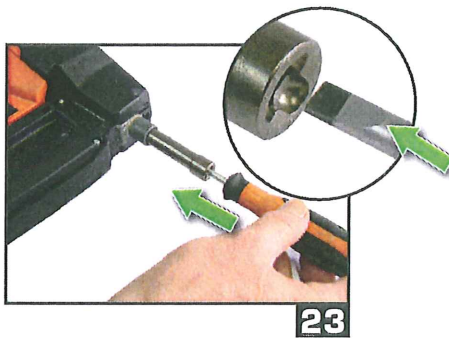
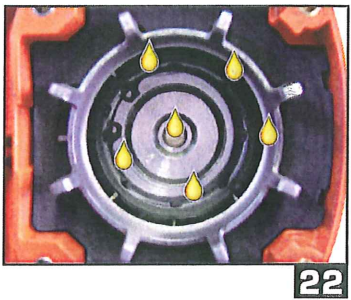
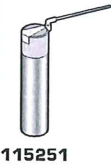
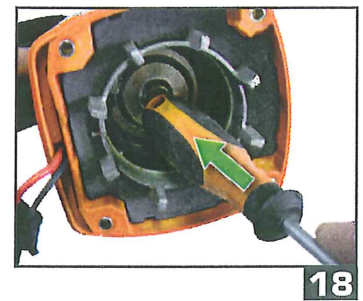
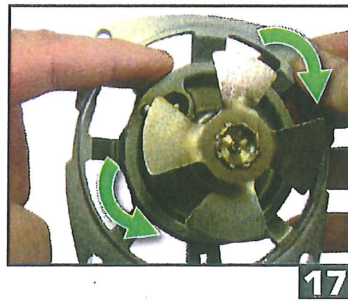
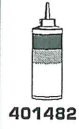

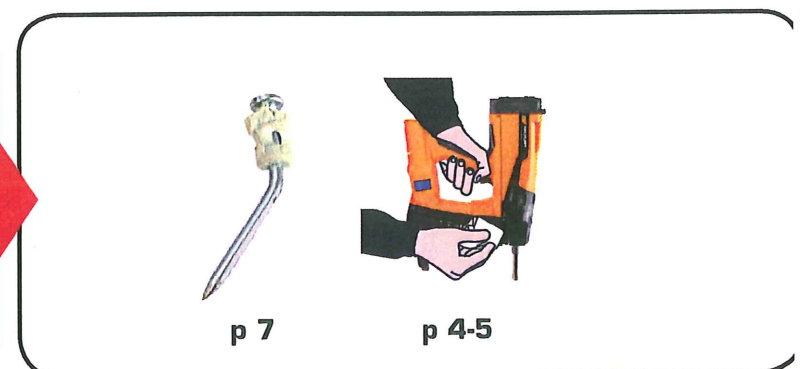
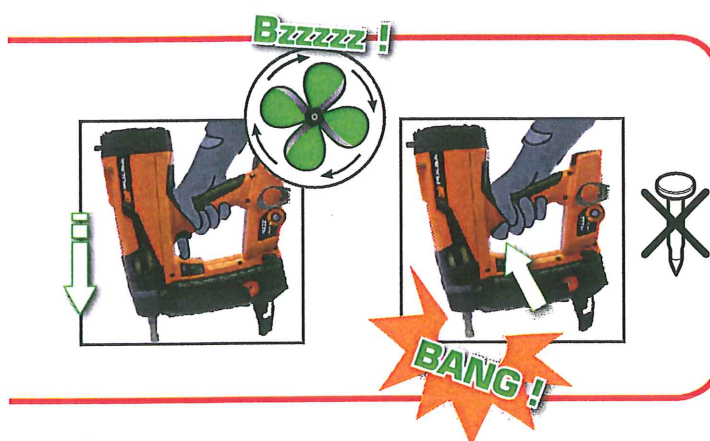
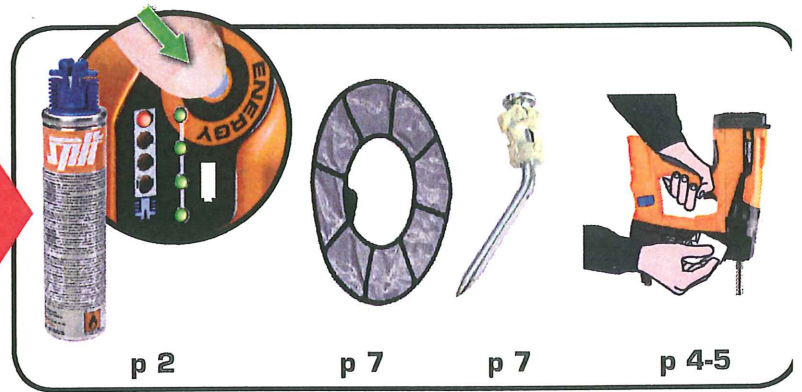
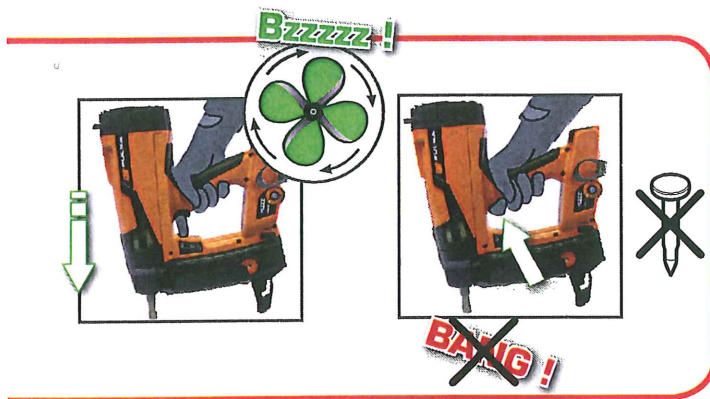
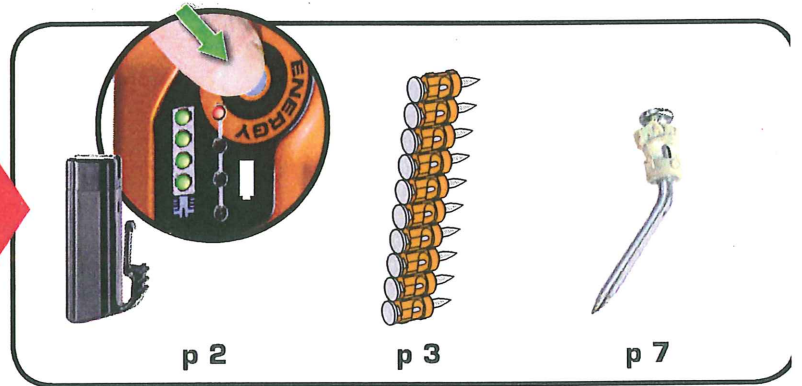
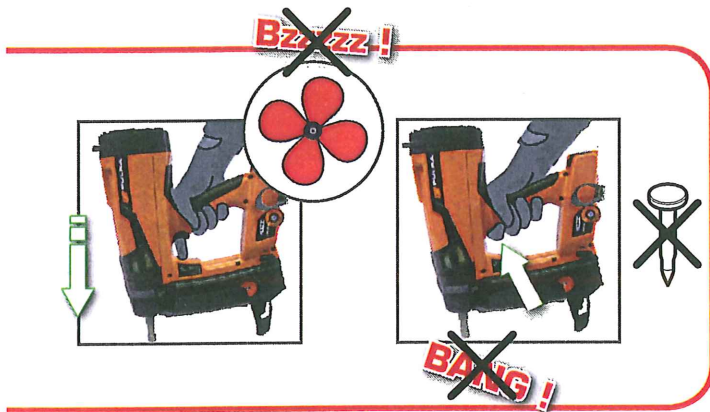
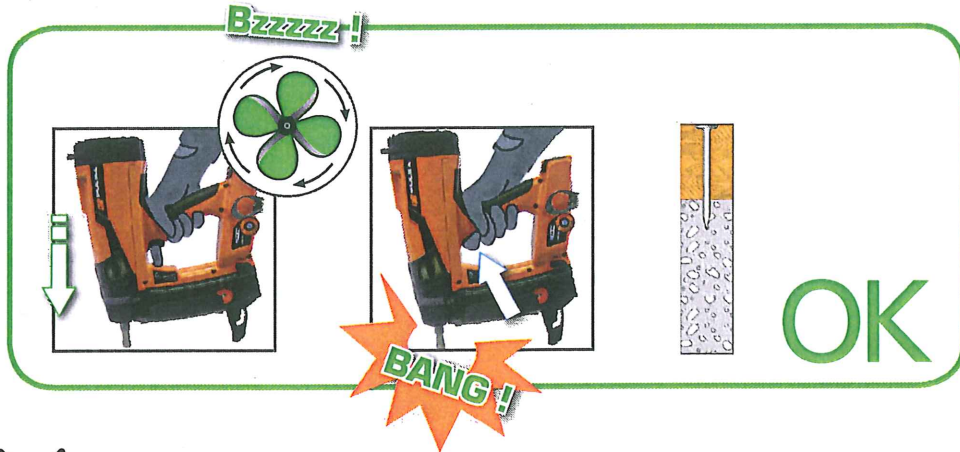
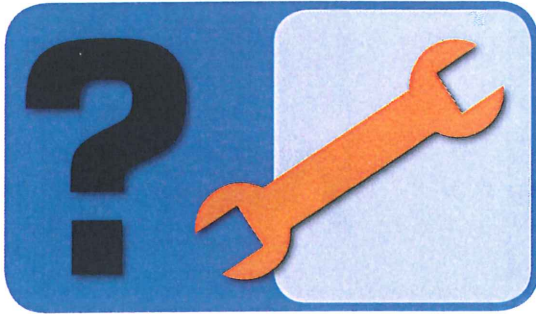

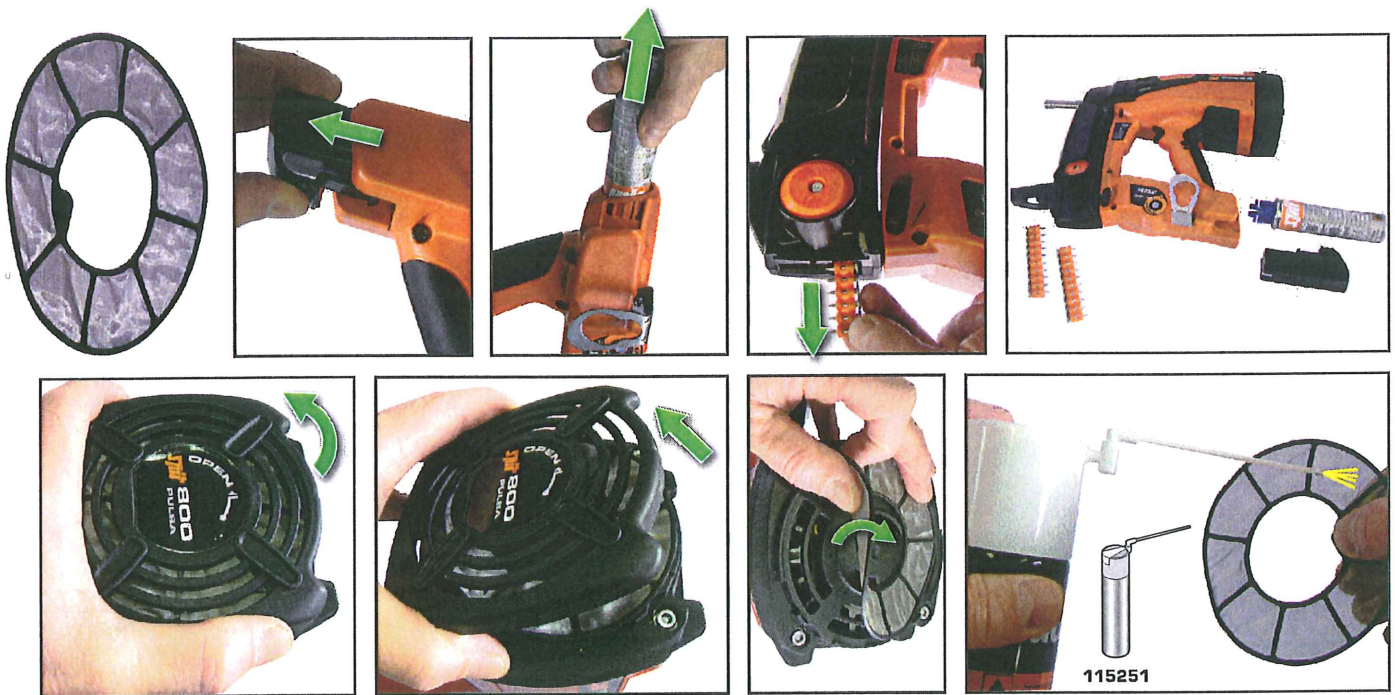
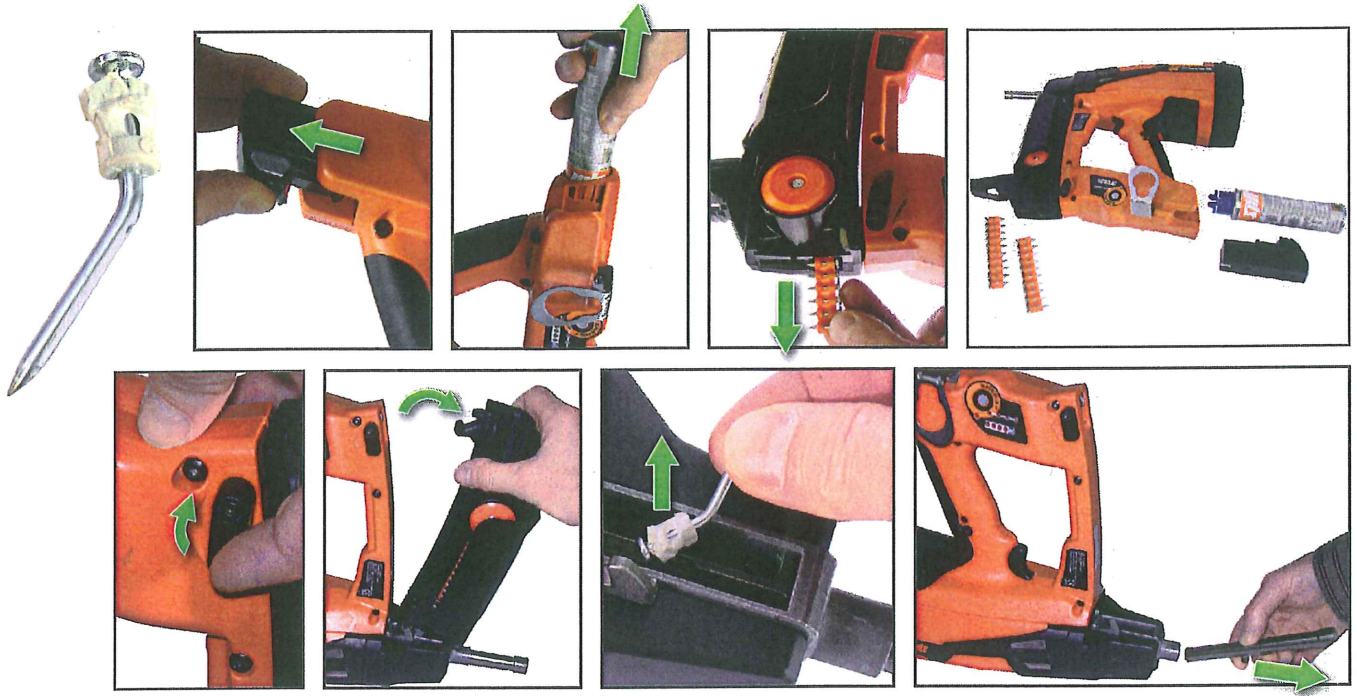

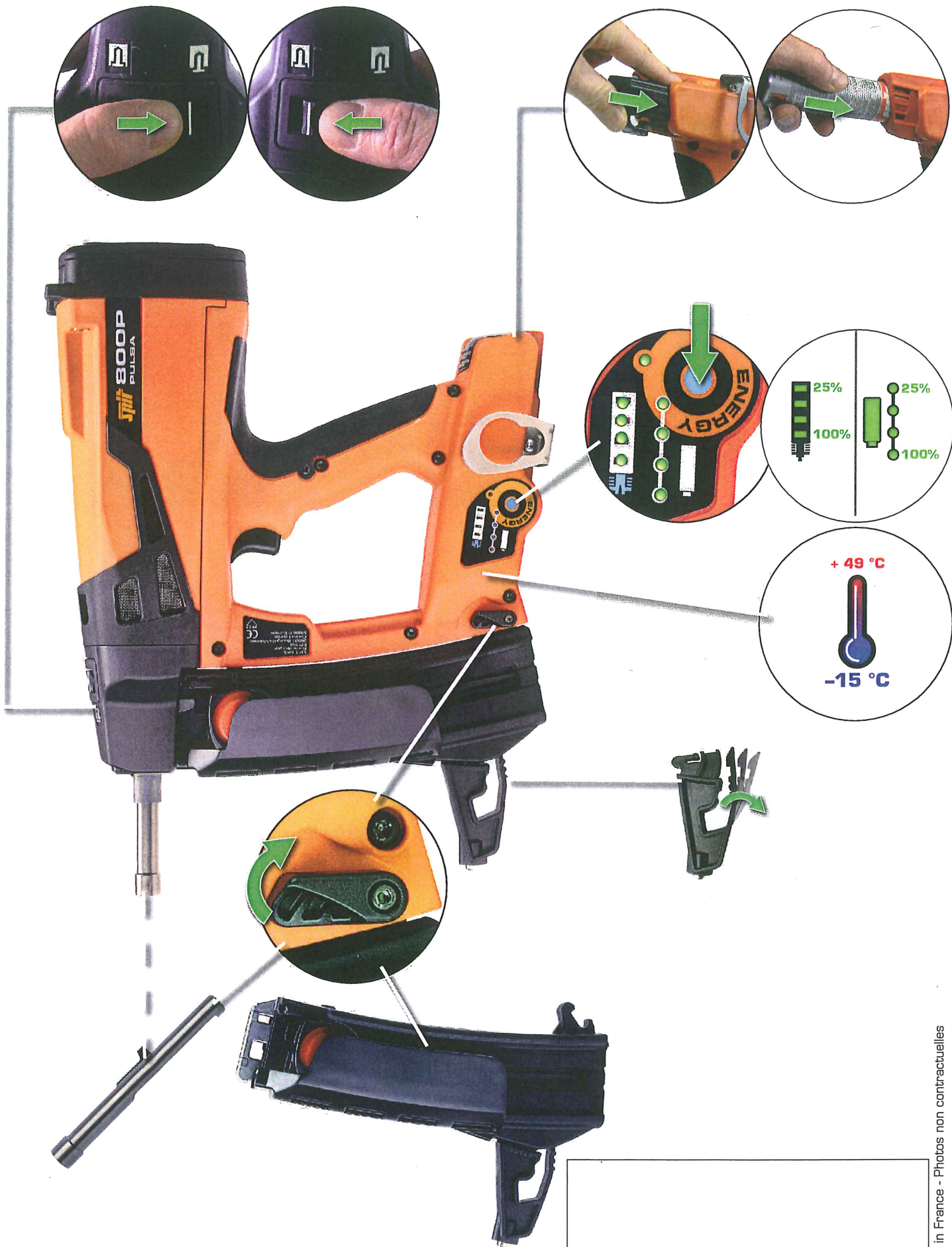

Route de Lyon - BP 104  
 F-26501 Bourg-lès-Valence  
 Cedex - FRANCE

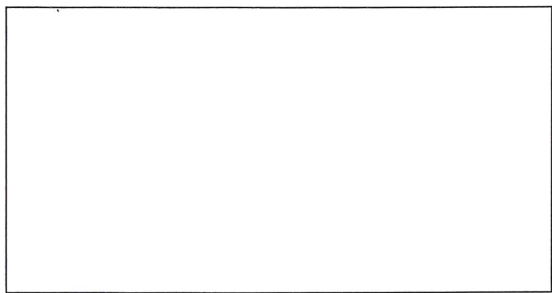

Réalisation Made in France - Photos non contractuelles