



**Paslode®**

# LCP Series



**LCP45**



**LCP45R**



**LCP45.1**



**LCP65**

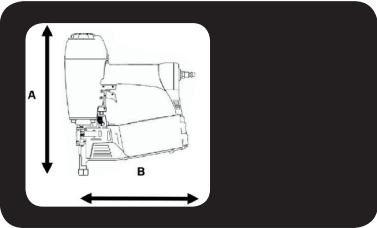

# LCP45

		<p>A = 282 mm B = 275 mm C = 159 mm</p>
		<p>= 1.65 kg</p>

Min. 5,5 bar  
Max. 8,3 bar

EN 12549+EN ISO 4871

L<sub>wA,1s</sub> = 103.8 dBA  
L<sub>pA,1s</sub> = 101.5 dBA  
L<sub>pA,1s,1m</sub> = 90.8 dBA

1,2 L (6 bar) /

EN1996 : 1997

ISO 8662-11

Vibration = 3.1 m/s<sup>2</sup>

Ps max. = 8,3 bar

150 x =

Paslode Nails 0° (GN Tape)

D= max. 7,0mm  
d = 2,5 - 2,8mm  
L = 25 - 35 mm

	<p>Sequential trigger actuation/ Einzelauslösung/ enkelschots/ Déclenchement du tir - mode séquentiel/ Funcionamiento secuencial "en continuo"/ Gatilho de actuação sequencial/ funzionamento sequenziale (colpo a colpo)/ Enkeltskuds aftrækker/ Enkelskott/ Enkeltskudds avtrekker/ Kertalaukaisu/ Üksiklasu meetodil töötamine/ Uruchromienie spustu sekwencyjne/ Sekvenčni spoušť/ Egyes lövés (szakaszosan működtetett elsőtű billentyűvel)/ Posamezno proženje/ Kontaktirajte singl / Последовательная активация при нажатии на курок/ Sekvenčná aktivácia spúšte/ التشغيل بالتسلسل المقيد / Nuoseklusis paleidimo mechanizmas/ Sekvencialās palaišanas iedarbināšana Raðkveikjувirkjun</p>
---	---





**Model: LCP45**  
**No. 575896**



**LCP45**  
**Pneumatic coil nailer**  
Code: 575896  
Trigger actuation: Sequential

**0° COIL**  







**GN-TAPE**  
Max. 7mm  
25-35  
2.5-2.8  
9.5  
7mm

CE    



ITW Befestigungssysteme GmbH  
30966 Hemmingen, Germany



**No. 617559**

					 3x
<b>No. 014748 + No. 576926</b>		<b>No. 576340</b>	<b>No. 014121</b>		

**Accessories**

	
<b>No. 505203</b> <b>Magazine insert</b>	<b>No. 151299 / No. 576216</b> <b>0,5 l oil / 1 l oil</b>

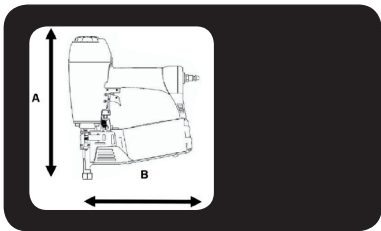

# LCP45R

		<p>A = 282 mm B = 275 mm C = 159 mm</p>
		= 1.9 kg

Min. 5,5 bar  
Max. 8,3 bar

EN 12549+EN ISO 4871

L<sub>wA,1s</sub> = 103.8 dBA  
L<sub>pA,1s</sub> = 101.5 dBA  
L<sub>pA,1s,1m</sub> = 90.8 dBA

1,2 L (6 bar) /

EN1996 : 1997

ISO 8662-11

Vibration = 3.1 m/s<sup>2</sup>

Ps max. = 8,3 bar



150 x =

Paslode Nails 0° (GN Tape)

D = max. 7,0 mm  
d = 2,3 - 2,5 mm  
L = 22 - 35 mm



 + = 

EN ISO 11148-13  
International  
Safety  
Standard

 	<p>Contact trigger actuation/ Kontaktauslösung/ repeterend schieten/ Déclenchement du tir - mode rafale/ Funcionamiento por contacto "clavo a clavo"/ Gatilho de actuação por contacto/ funcionamento a contacto/ Stødskydnings aftrækker/ Støtskjutning/ Støtspikrings avtrekker/ Kosketuslaukaisu/ Automaatmeetodil töötamine/ Uruchomienie spustu przez kontakt/ Kontaktní spoušť/ Sorozatlövés (folyamatosan behúzott elsütő billentyűvel)/ Kontaktno proženje/ Kontaktirajte pokretanje/ Контактная активация при нажатии на курок/ Kontaktná aktivácia spúšte/ التشغيل بتلامس الزر / Kontaktinis paleidimo mechanizmas/ Kontakta palaides iedarbināšana/ Snertikveikjvirkjun</p>
---	--

<p><b>Model: LCP45R</b> <b>No. 575909</b></p>				
 <p><b>LCP45R</b> Pneumatic coil nailer Code: 575909 Trigger actuation: Contact</p>	<p><b>0° COIL</b> </p> <p><b>GN-TAPE</b> Max. 7 mm </p>	    <p>ITW Befestigungssysteme GmbH 30366 Hemmingen, Germany</p>		
 <p><b>No. 617559</b></p>				
				 <b>3x</b>
<p><b>No. 014748 + No. 576926</b></p>	<p><b>No. 014121</b></p>			

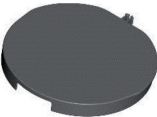
**Accessories**

	
<p><b>No. 505203</b> <b>Magazine insert</b></p>	<p><b>No. 151299 / No. 576216</b> <b>0,5 l oil / 1 l oil</b></p>

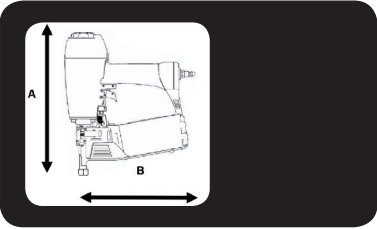

# LCP65

		<p>A = 330 mm B = 312 mm C = 151 mm</p>
		= 2,4 kg

Min. 5,5 bar  
Max. 8,3 bar

L wA,1s = 107.6 dBA  
L pA,1s = 106.8 dBA  
L pA,1s,1m = 94.6 dBA

1,7 L (6 bar) /

EN 12549+EN ISO 4871  
EN1996 : 1997  
 ISO 8662-11  
Vibration = 4,0 m/s<sup>2</sup>

Ps max. = 8,3 bar

150 x =

Paslode Nails 0° (GN Tape)







D = max. 8,0 mm  
d = 2,5 - 4,2 mm  
L = 32 - 65 mm

+ =



	Sequential trigger actuation/ Einzelauslösung/ enklenschots/ Déclenchement du tir - mode séquentiel/ Funcionamiento secuencial "en continuo"/ Gatilho de actuação sequencial/ funzionamento sequenziale (colpo a colpo)/ Enkeltskuds aftrækker/ Enkelskott/ Enkeltskudds avtrekker/ Kertalaukaisu/ Úksiklasu meetodil töötamine/ Uruchomienie spustu sekwencyjne/ Sekvenční spoušť/ Egyes lövés (szakaszosan működtetett elsütő billentyűvel)/ Posamezno proženje/ Kontaktirajte singl / Последовательная активация при нажатии на курок/ Sekvenčná aktivácia spúšte/ التشغيل بالزر التسلسلي المقيد / Nuoseklusis paleidimo mechanizmas/ Sekvenciālās palaides iedarbināšana Raðkveikjувirkjun
---	--

	Contact trigger actuation/ Kontaktauslösung/ repeterend schieten/ Déclenchement du tir - mode rafale/ Funcionamiento por contacto "clavo a clavo"/ Gatilho de actuação por contacto/ funcionamiento a contacto/ Stødskydnings aftrækker/ Støtskjutting/ Støtspikrings avtrekker/ Kosketuslaukaisu/ Automaatmeetodil töötamine/ Uruchomienie spustu przez kontakt/ Kontaktní spoušť/ Sorozatlövés (folyamatosan behúzott elsütő billentyűvel)/ Kontaktno proženje/ Kontaktirajte pokretanje/ Контактная активация при нажатии на курок/ Kontaktná aktivácia spúšte/ التشغيل بتلامس الزر / Kontaktinis paleidimo mechanizmas/ Kontakta palaides iedarbināšana/ Snertikveikjувirkjun
---	---

<b>Model: LCP65</b>	<b>No. 575900</b>		
			
			<b>No. 575641</b>

					
<b>No. 014748 + No. 576926</b>		<b>No. 576340</b>	<b>No. 014121</b>		

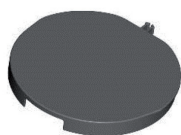
**Accessories**

		
<b>No. 576487</b>	<b>No. 505203</b>	<b>No. 151299 / No. 576216</b>
Hanger	Magazine insert	0,5 l oil / 1 l oil

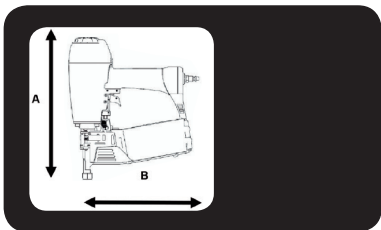

# LCP45.1

		<b>A = 293 mm</b> <b>B = 312 mm</b> <b>C = 151 mm</b>
		= 2.1 kg

	<b>Min. 5,5 bar</b> <b>Max. 8,3 bar</b>
<b>1,4 L (6 bar) /</b>	
<b>Ps max. = 8,3 bar</b>	

	<b>L<sub>wA,1s</sub> = 82.7 dBA</b> <b>L<sub>pA,1s</sub> = 72.3 dBA</b> <b>L<sub>pA,1s,1m</sub> = 69.7 dBA</b>
<small>EN 12549+EN ISO 4871</small>	
<small>EN1996 : 1997</small> 	<b>Vibration = 4.4 m/s<sup>2</sup></b>

<b>150 x</b>		
<b>Paslode Nails 0° (GN Tape)</b>		
		<b>D = max. 8,0 mm</b> <b>d = 2,5 - 4,0 mm</b> <b>L = 22 - 45 mm</b>





Sequential trigger actuation/ Einzelauslösung/ enkelschots/ Déclenchement du tir - mode séquentiel/ Funcionamiento secuencial "en continuo"/ Gatilho de actuação sequencial/ funzionamento sequenziale (colpo a colpo)/ Enkeltskuds aftrækker/ Enkelskott/ Enkeltskudds avtrekker/ Kertalaukaisu/ Üksiklasu meetodil töötamine/ Uruhomienie spustu sekwencyjne/ Sekvenční spoušť/ Egyes lövés (szakaszosan működtetett elsütő billentyűvel)/ Posamezno proženje/ Kontaktirajte singl / Последовательная активация при нажатии на курок/ Sekvenčná aktivácia spúšte/ التشغيل بالزر التسلسلي المقيد / Nuoseklusis paleidimo mechanizmas/ Sekvenčiālās palaiides iedarbināšana Raðkveikjувirkjun

**Model: LCP45.1**  
**No. 575898**



**LCP45.1**  
Pneumatic coil nailer  
Code: 575898  
Trigger actuation: Sequential

**0° COIL**



**GN-TAPE**









CE





ITW Befestigungssysteme GmbH  
30966 Hemmingen, Germany



**No. 617559**

					 <p><b>3x</b></p>
<b>No. 014748 + No. 576926</b>		<b>No. 576340</b>	<b>No. 014121</b>		

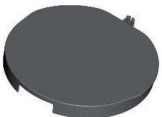
**Accessories**

	
<b>No. 505203</b>	<b>No. 151299 / No. 576216</b>
<b>Magazine insert</b>	<b>0,5 l oil / 1 l oil</b>

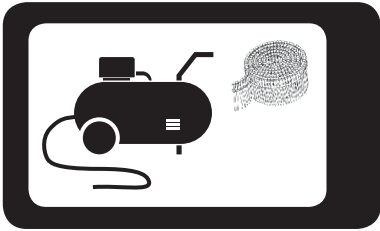

014 748

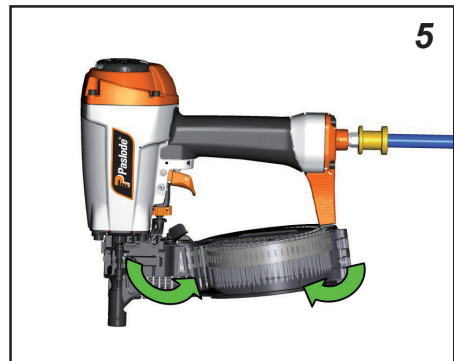
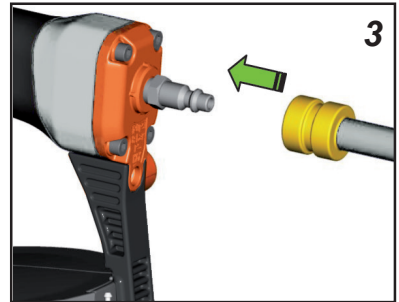
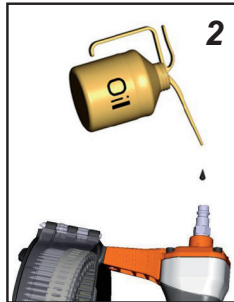
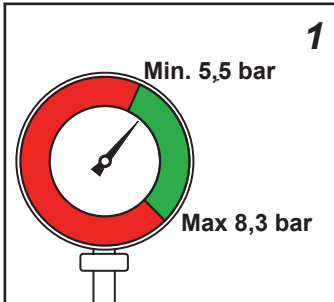

LCP45 + LCP45R:	L < 30
LCP65:	L < 50 mm

+

No. 505203

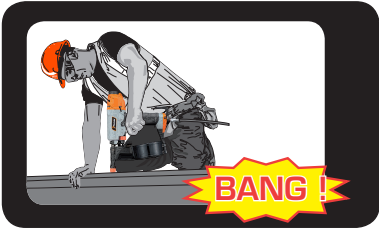

014 748

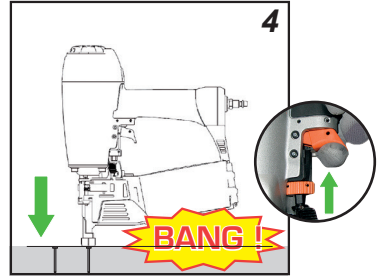
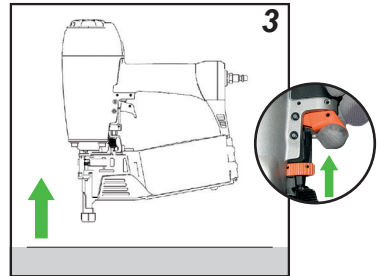
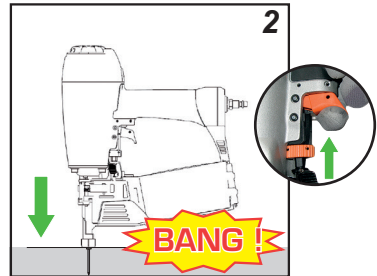
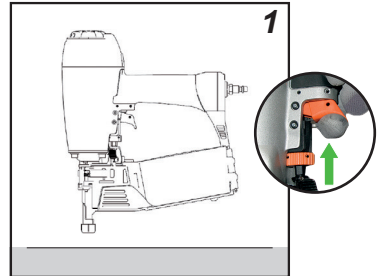
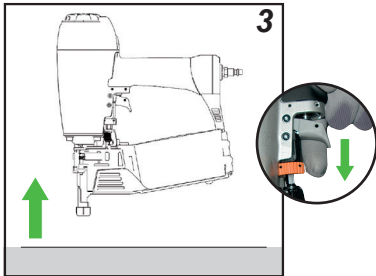
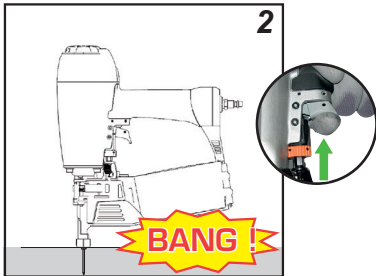
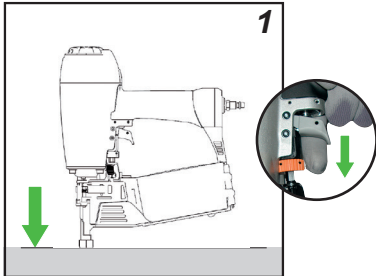

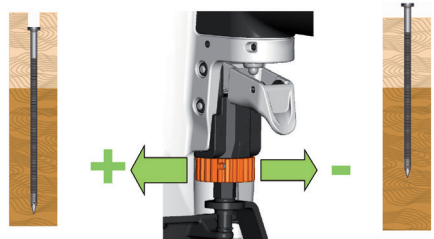
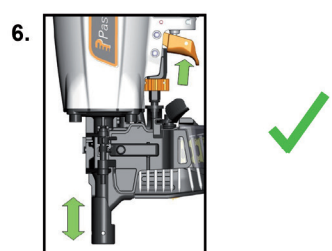
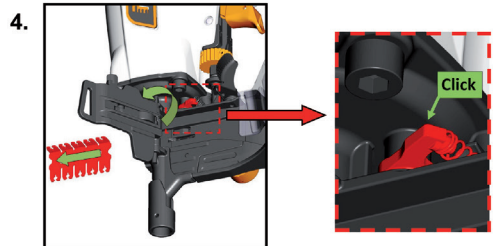
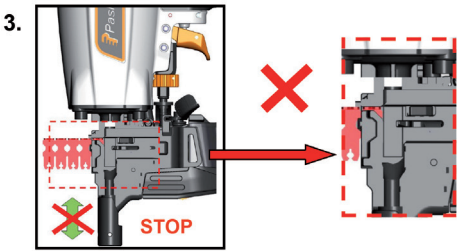
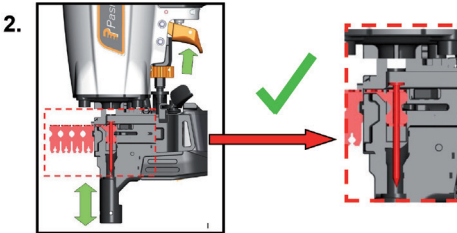
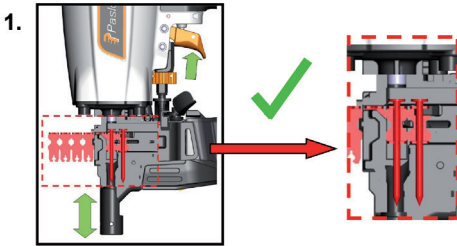
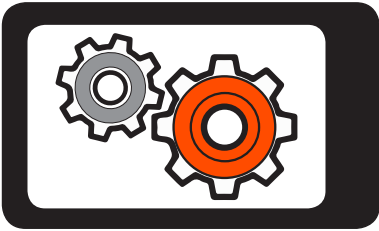

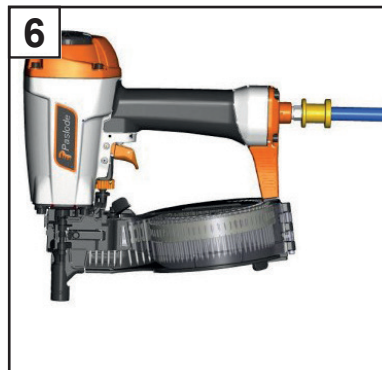
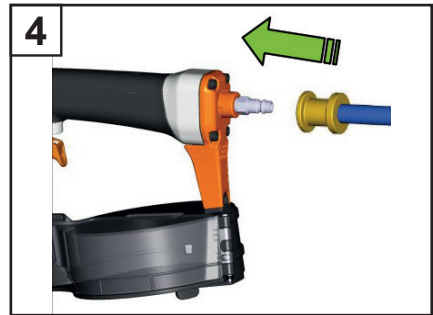
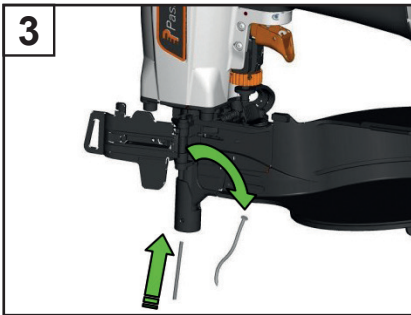
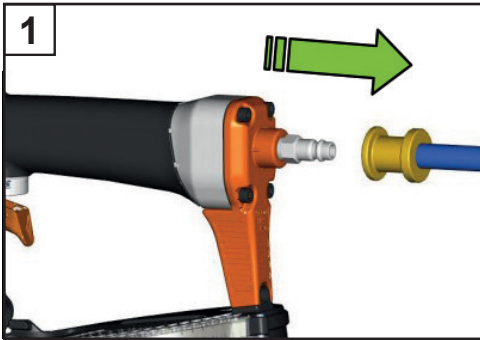
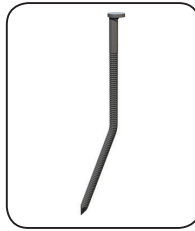
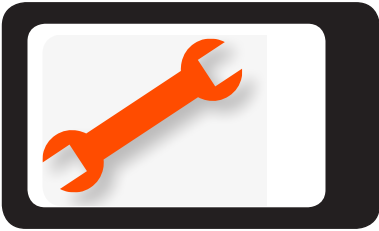

YY/WW....

YY= Year of manufacture  
WW = Week of manufacture



**Resting position/ Ruheposition/ Position de repos/ Ruststand/  
Posición de descanso/ Posizione di riposo/ Posição de des-  
canso/ Pozycja spoczynku/ Klidová poloha/ Nyugalmi állapot/  
Положение в нерабочем состоянии/ Θέση αδράνειας/ Hviles-  
tilling/ Viloläge/ Hvileposisjon/ Lepoasento/ Položaj mirovanja/  
Pokojóvá poloha/ Položaj mirovanja/ وضع السكون / Ramybės  
padėtis/ Ooteasend/ Miera stāvoklis/ Hvíldarstaða**





ITW CONSTRUCTION PRODUCTS EUROPE  
Code 575926 (05/2019)  
[www.spitpaslode.com](http://www.spitpaslode.com)