

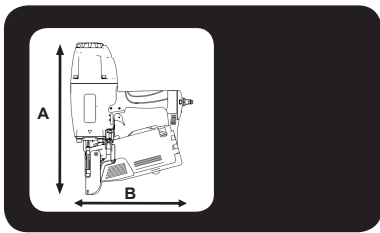

**haubold®**

**RNC90Z**





# RNC90Z

		<p>A = 414 mm B = 316 mm C = 136 mm</p>
		<p>= 3,45 kg</p>

<p>2,55 l (6 bar) / </p>
<p>Ps max. = 8,3 bar</p>

<p>EN 12549+EN ISO 4871</p>	<p>L WA.1s = 100 dBA L pA.1s = 90 dBA L pA.1s1m = 87 dBA</p>
<p>ISO 8662-11</p>	<p>Vibration = 3,2 m/s<sup>2</sup></p>

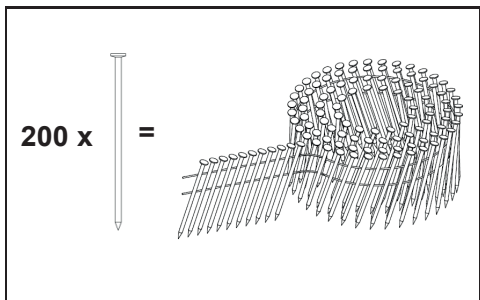

<b>NAIL / COLLATION SPECIFICATION NAGEL / ANBINDUNG SPEZIFIKATION</b>	
Welded-wire coil nails / Drahtgebundene Nägel	Plastic sheet coil nails / Plastikgebundene Nägel















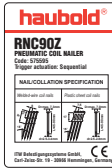

+



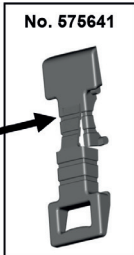



=



	<p>Sequential trigger actuation/ Einzelauslösung/ enkelschots/ Déclenchement du tir - mode séquentiel/ Funcionamiento secuencial "en continuo"/ Gatilho de actuação sequencial/ funcionamiento secuencial (colpo a colpo)/ Enkeltskuds aftrækker/ Enkeltskott/ Enkeltskudds avtrekker/ Kertalaukaisu/ Üksiklasu meetodil töötamine/ Uruchomienie spustu sekwencyjne/ Sekvenční spoušť/ Egyes lövés (szakaszosan működtetett elsütő billentyűvel)/ Posamezno proženje/ Kontaktirajte singl / Последовательная активация при нажатии на курок/ Sekvenčná aktivácia spúšte/ التشغيل بالزر التسلسلي المقيد / Nuoseklusis paleidimo mechanizmas/ Sekvenciālās palaišanas iedarbināšana Račkovjejuvirkjun</p>
	<p>Contact trigger actuation/ Kontaktauslösung/ repeterend schieten/ Déclenchement du tir - mode rafale/ Funcionamiento por contacto "clavo a clavo"/ Gatilho de actuação por contacto/ funcionamiento a contacto/ Stødskydning aftrækker/ Støtskjutning/ Støtspikrings avtrekker/ Kosketuslaukaisu/ Automaatmeetodil töötamine/ Uruchomienie spustu przez kontakt/ Kontaktní spoušť/ Sorozatlövés (folyamatosan behűzött elsütő billentyűvel)/ Kontaktno proženje/ Kontaktirajte pokretanje/ Контактная активация при нажатии на курок/ Kontaktná aktivácia spúšte/ التشغيل بتلامس الزر / Kontaktinis paleidimo mechanizmas/ Kontakta palaišanas iedarbināšana/ Snertikvejuvirkjun</p>

<p><b>Model: RNC90Z</b> <b>No. 575595</b></p>  	<p><b>Sequential actuation</b></p> 	<p><b>Model: RNC90Z</b> <b>No. 575596</b></p>  	<p><b>Contact actuation</b></p> 	
		  <p><b>No. 576641</b></p>		
<p>Power tool accessories</p> 				
<p><b>No. 014748 + No. 575600</b></p>		<p><b>No. 014121</b></p>		

**Accessories**

				
<p><b>No. 151299 / No. 576216</b></p>		<p><b>No. 574494</b></p>	<p><b>No. 575643</b></p>	<p><b>No. 617375</b></p>
<p><b>0,5 l oil / 1 l oil</b></p>		<p><b>Hanger</b></p>	<p><b>Flat Safety Lever</b></p>	<p><b>Flat Rubber Pad</b></p>

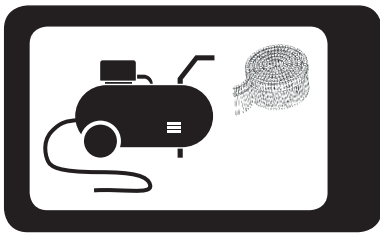

014 748

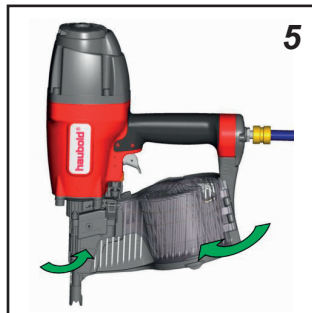
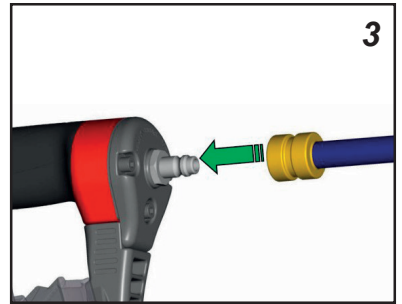
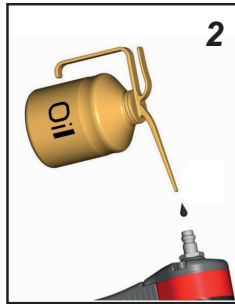
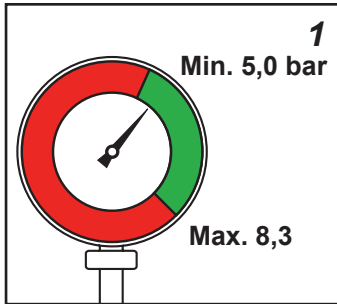

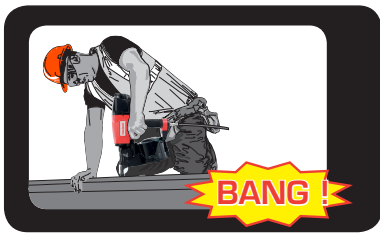

014 748

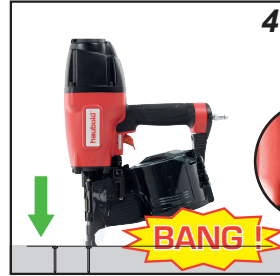
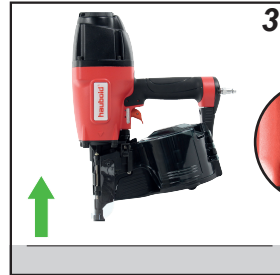
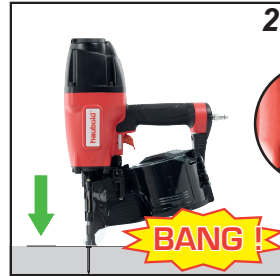

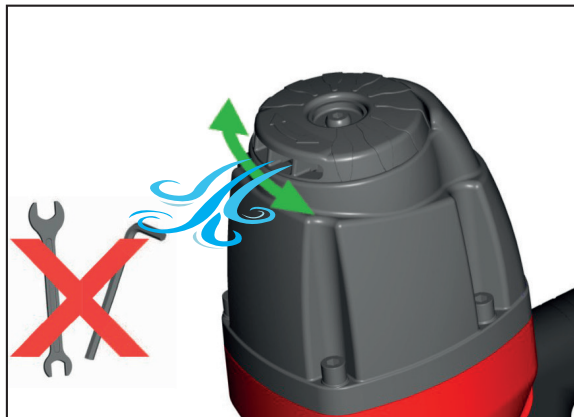
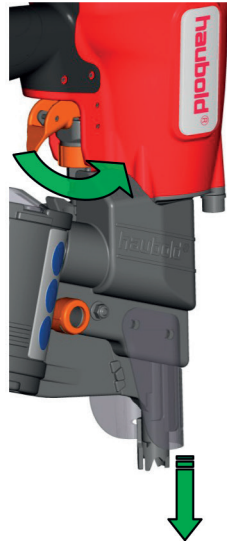
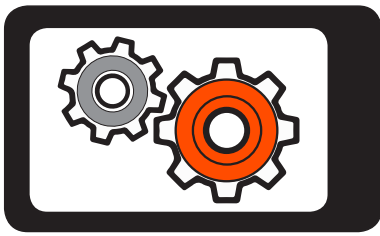

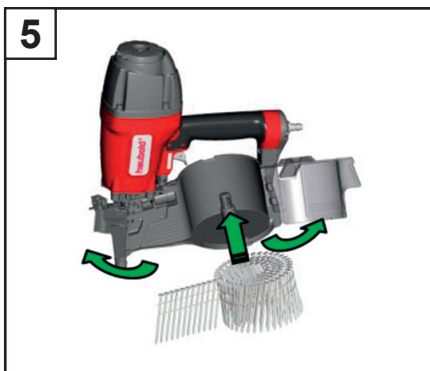
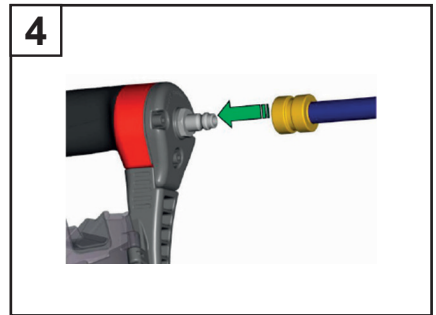
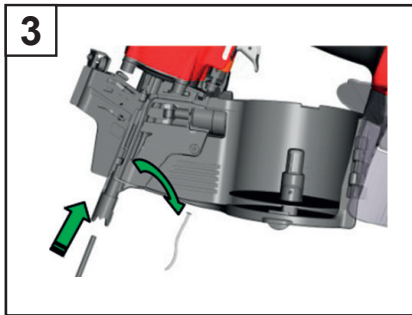
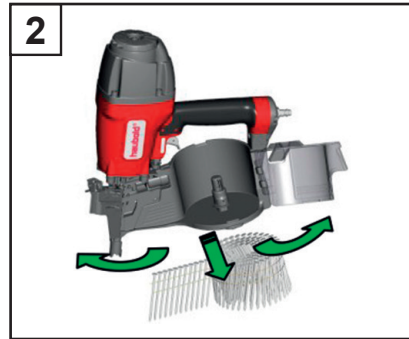
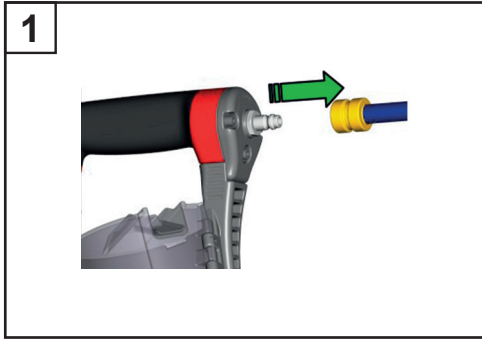
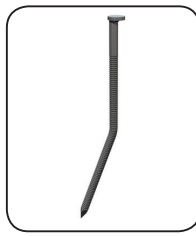
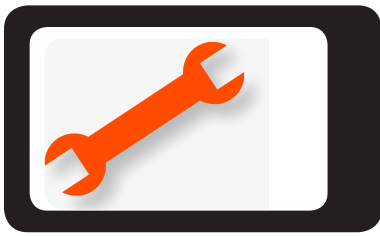

YY/WW....

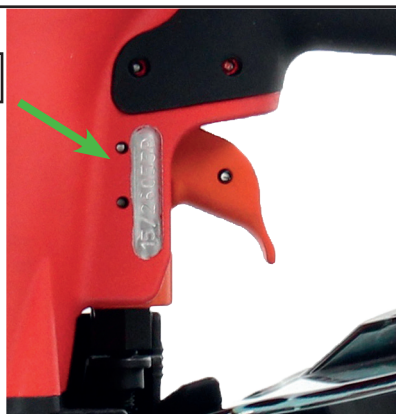

YY= Year of manufacture  
WW = Week of manufacture

**Resting position/ Ruheposition/ Position de repos/ Ruststand/  
Posición de descanso/ Posizione di riposo/ Posição de des-  
canso/ Pozycja spoczynku/ Klidová poloha/ Nyugalmi állapot/  
Положение в нерабочем состоянии/ Θέση αδράνειας/ Hvile-  
tilling/ Viloläge/ Hvileposisjon/ Lepoasento/ Položaj mirovanja/  
Pokožová poloha/ Položaj mirovanja/ وضع السكون / Ramybės  
padėtis/ Ooteasend/ Miera stāvoklis/ Hvíldarstaða**







ITW CONSTRUCTION PRODUCTS EUROPE  
Code 575600 (05/2019)  
[www.spitpaslode.com](http://www.spitpaslode.com)