

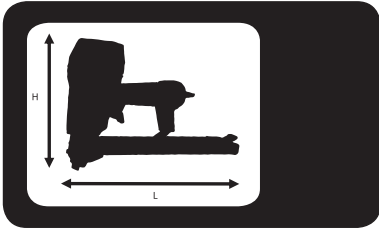

Paslode®

PCF12







PCF12

		A = 251 mm B = 429 mm C = 77 mm
		kg = 2.95 kg

 Max. = 8,3bar Min. = 5bar	 EN 12549 +En ISO 4871	L_{wA,1s} = 92 dBA
		L_{pA,1s} = 92 dBA
		L_{pA,1s,1m} = 93 dBA
1,1 L (7 bar) /	EN12096 : 1997 ISO 8662-11	Vibration < 3,1 m/s ²
Ps max= 8,3 bar		

 3x	225x
Paslode Corrugated Fastener (CF-Plast)	



 	<p>Contact trigger actuation/ Kontaktauslösung/ repeterend schieten/ Déclenchement du tir - mode rafale/ Funcionamiento por contacto "clavo a clavo"/ Gatilho de actuação por contacto/ funcionamento a contacto/ Stødskydnings aftrækker/ Støtskjutning/ Støtspikrings avtrekker/ Kosketuslaukaisu/ Automaatmeetodil töötamine/ Uruchromienie spustu przez kontakt/ Kontaktní spoušť/ Sorozatlövés (folyamatosan behúzott elsütő billentyűvel)/ Kontaktno proženje/ Kontaktirajte pokretanje/ Контактная активация при нажатии на курок/ Kontaktná aktivácia spúšte/ التشغيل بتلامس الزر / Kontaktninis paleidimo mechanizmas/ Kontakta palaides iedarbināšana/ Snertikveikjuvirkjun</p>
--------------------------------------------------------------------------------------------------------------------------------------------------------------------	-------------------------------------------------------------------------------------------------------------------------------------------------------------------------------------------------------------------------------------------------------------------------------------------------------------------------------------------------------------------------------------------------------------------------------------------------------------------------------------------------------------------------------------------------------------------------------------------------------------------------------------------------------------------------------------------

<p>Model: PCF 12 No. 574870</p>			
 <p>PCF12 CORRUGATED FASTENER TOOL Code: 574870 Trigger actuation: Contact</p>	 <p>10mm 13mm 26 mm</p> <p>$P_{max} = 8.3 \text{ bar}$</p>  <p>ITW Befestigungssysteme GmbH, Carl-Zeiss-Str. 19 - 30966 Hemmingen, Germany</p> 		
			
<p>No. 014748 + No. 575028</p>		<p>No. 014121</p>	<p>No. 502421</p>

Accessories

<p>No. 151299 / No. 576216</p>
<p>0,5 l oil / 1 l oil</p>

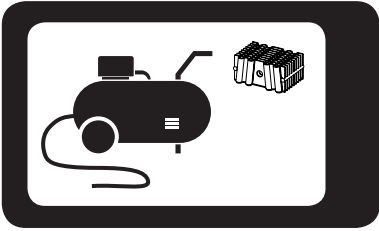

014 748

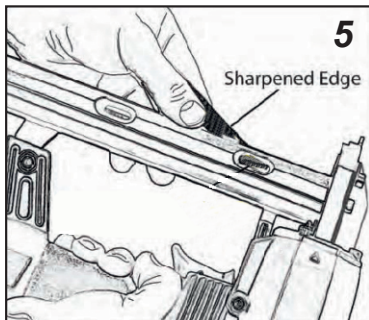
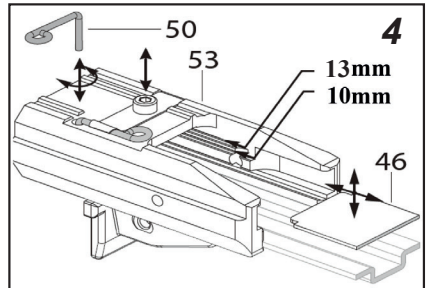
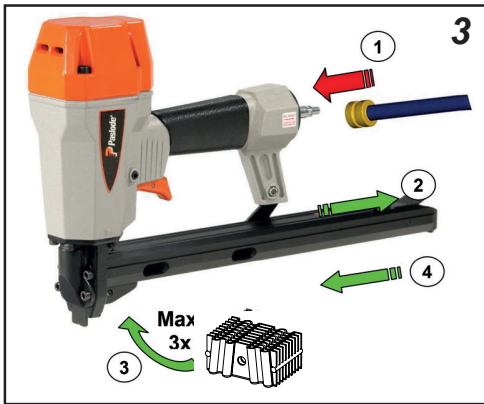
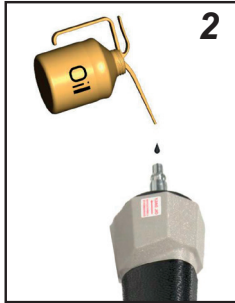
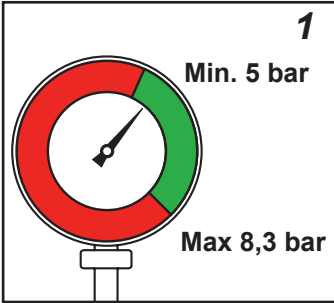

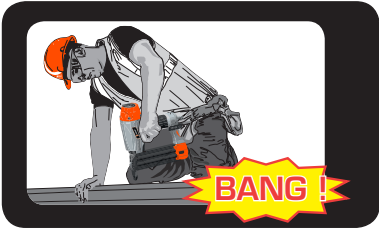

014 748

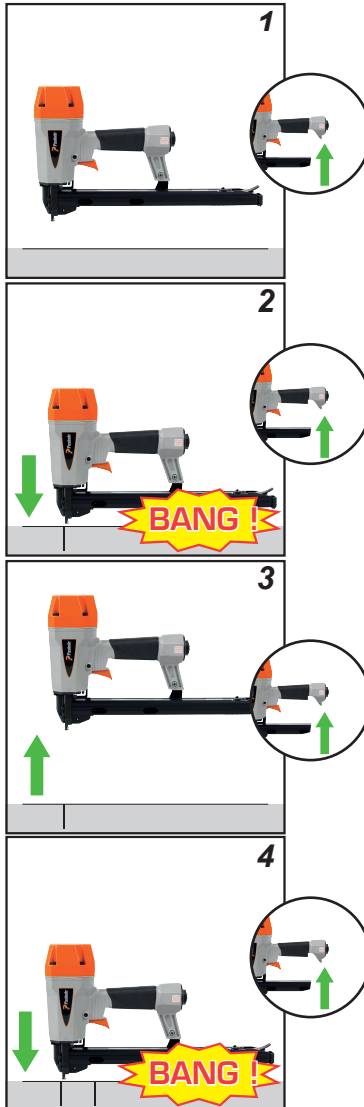

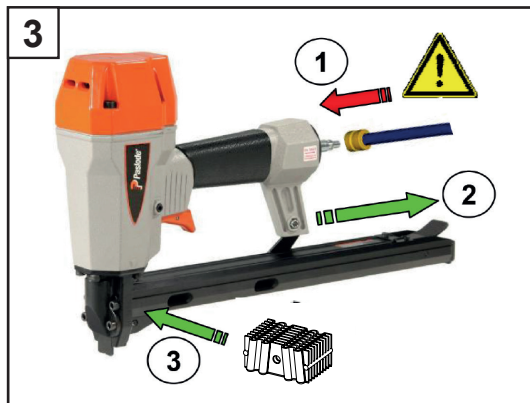
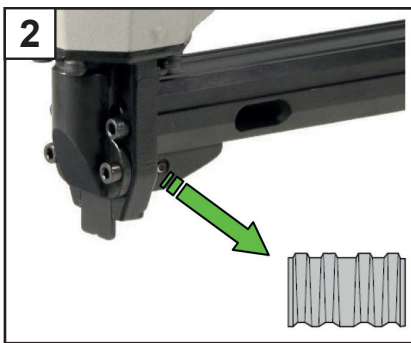
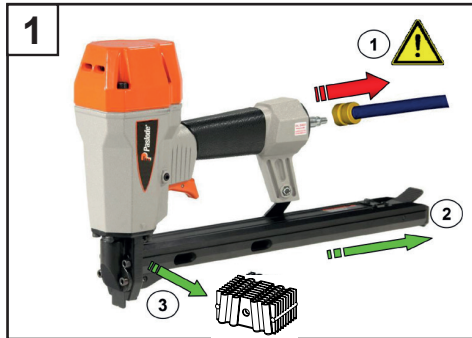
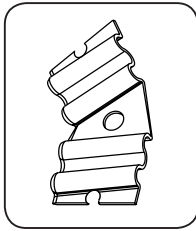
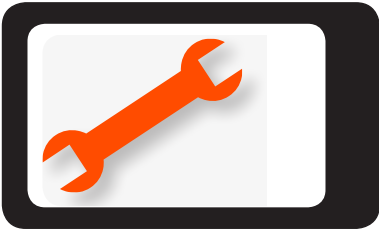

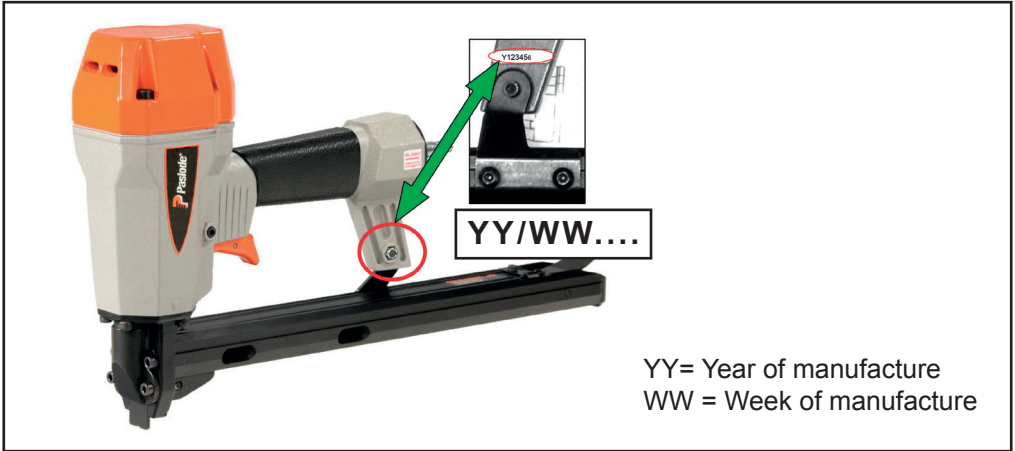

Resting position/ Ruheposition/ Position de repos/ Ruststand/ Posición de descanso/ Posizione di riposo/ Posição de descanso/ Pozycja spoczynku/ Klidová poloha/ Nyugalmi állapot/ Положение в нерабочем состоянии/ Θέση αδράνειας/ Hviletilling/ Viloläge/ Hvileposisjon/ Leroasento/ Položaj mirovanja/ Pokojová poloha/ Položaj mirovanja/ وضع السكون / Ramybės padėtis/ Ooteasend/ Miera stāvoklis/ Hvíldarstaða



NOTES:





ITW CONSTRUCTION PRODUCTS EUROPE
Code 575028 (05/2019)
www.spitpaslode.com