

Uponor MLC Modulsystem 63 - 110 mm - En revolusjon innen installasjon!

Nytenkning



Uponor MLC Modulsystem 63 - 110 mm - Modulsystemet som takler alle utfordringer

Maksimal fleksibilitet med kun 26 deler

Uponor MLC Modulsystem 63 - 110 mm består av få komponenter, hvor alle er tilpasset hverandre. Delene som er til rådighet dekker alle størrelser som er nødvendige for å bygge opp et komplett modulsystem.

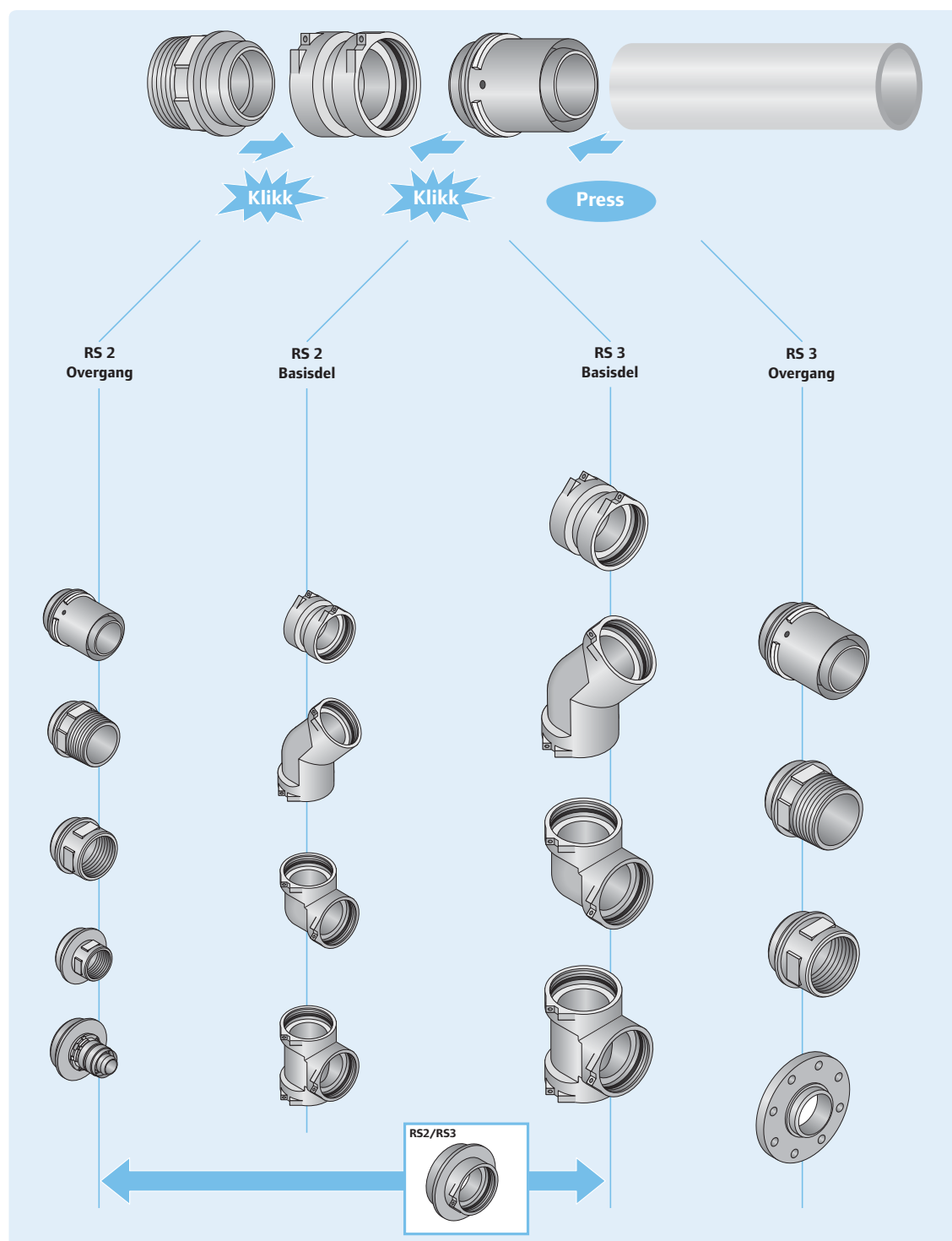

Det nye Uponor MLC Modulsystem 63 - 110 mm: Enkel montering, fleksibel planlegging og optimalt innkjøp

Enestående og innovativt modulsystem revolusjonerer installasjonsteknikken. Modulært fittingsystem med gjennomtestet pressteknikk for rørforbindelser opp til Ø 110 mm!

Det nye Uponor MLC Modulsystem - Modulært design for alle tenkelige kombinasjoner:

- Kun 26 systemkomponenter muliggjør hundrevis av variasjoner.
- Nytt koblingskonsept: Basisdeler og tilhørende overgangssatser i messing.
- Gjennomtestet pressteknikk for rørforbindelser.
- Ny type stikkforbindelse mellom basisdel og overgang.
- Ekstraverktøy er ikke nødvendig
- Man kan bruke det velkjente pressverktøyet UP 75 helt opp til Ø 110 mm



Uponor MLC Modulsystem muliggjør med kun 26 systemkomponenter alle mulige forbindelser og erstatter 300 fittings.



Basisdeler og overgang muliggjør alle tenkelige forbindelser.



Mye større fleksibilitet med færre deler.



Sjeldne forbindelsestyper løses enkelt med Uponor Modulsystem 63 -110 mm.

Én prosedyre på alle oppgaver

På grunn av modulsystemets oppbygning, består alle koblinger av de samme 5 trinn. Pressverktøyet blir kun benyttet til press og denne arbeidsgangen kan derfor enkelt gjennomføres på arbeidsbordet. Det er ikke lenger nødvendig å stå i ubekvemme arbeidsstillinger for å kunne gjennomføre koblinger.



Press ganske enkelt det avtagbare og kalibrerte Uponor MLCP rør inn i overgangen.



Press.



Stikk den forberede rørforbindingen inn i basisdelen.



Selv på vanskelige steder er monteringen enkel å gjennomføre.

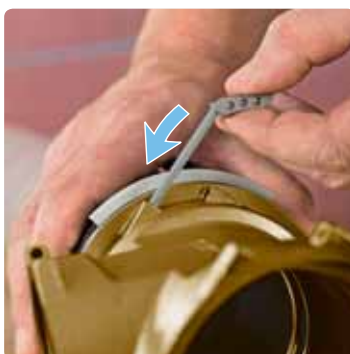

Stikk låsestiften inn i fittings.



Fest enden av låsestiften fast til fittingsen med et klikk.

Kombinasjonsmulighetene gjør systemet svært fleksibelt

Modulsystemets oppbygning gir alltid en rask løsning. Uten lange leveringstider og ekstraomkostninger for spesialdeler.

Eksempler av varianter med T-stykke

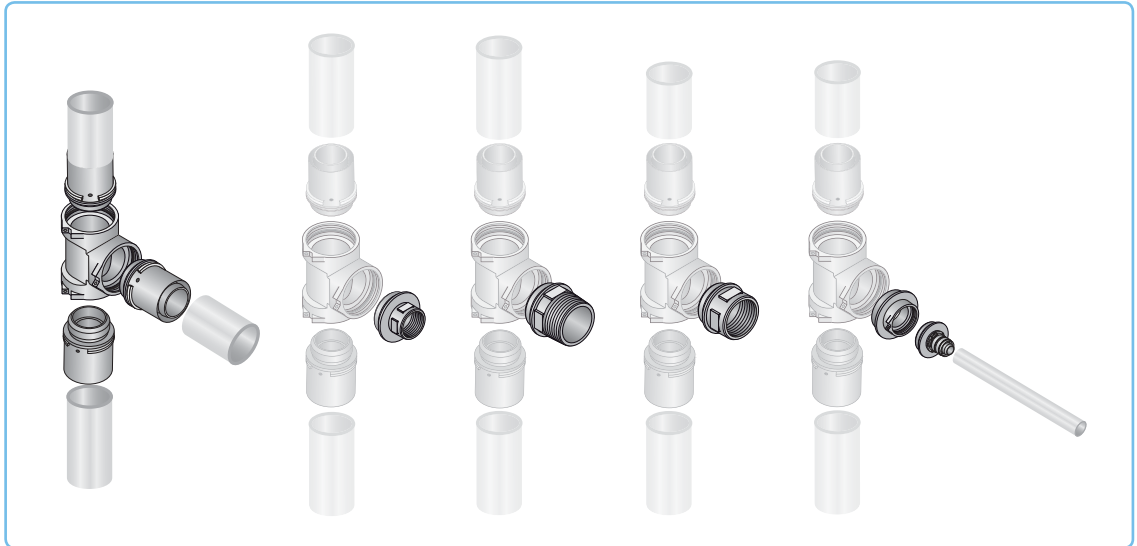

Eksempler med 45° albuer eller 90° albuer



Eksempler med koblinger og reduksjoner

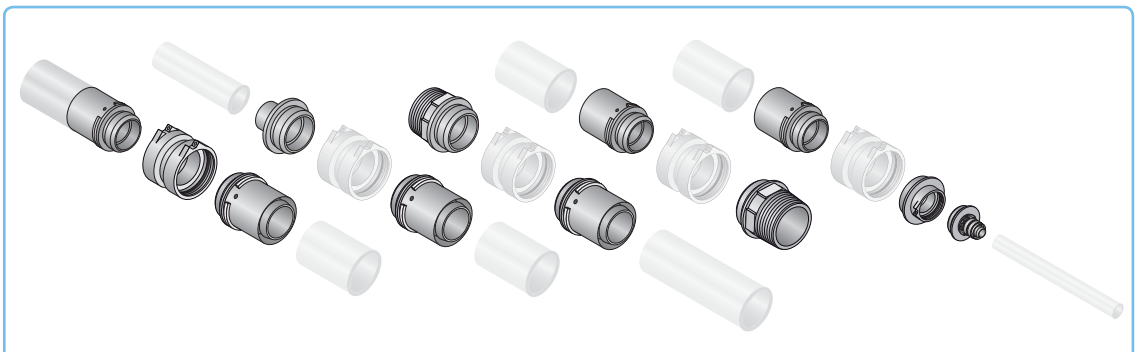

Eksempler

T-stykke med reduksjon

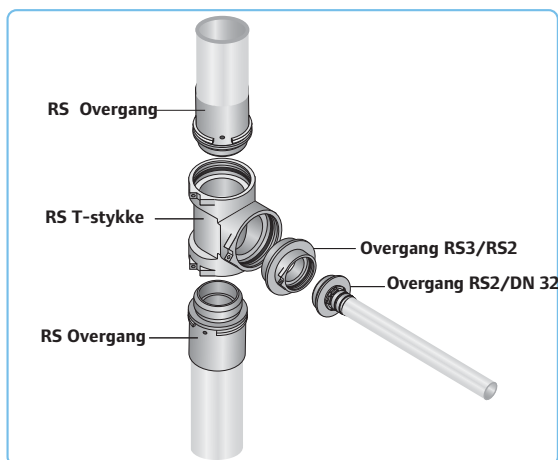

Nødvendige deler til denne forbindelsen



1 x Uponor RS T-Stykke



2 x Uponor RS Overgang 40-110 MLC



1 x Uponor RS Kobling, reduksjon



Uponor RS Overgang 25-32 MLC

Uponor Albue MLC

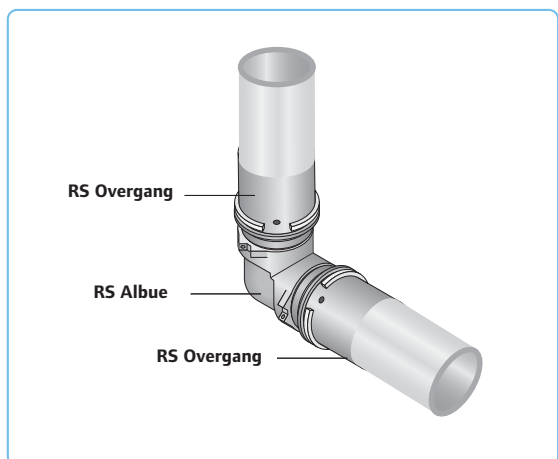

Nødvendige deler til denne forbindelsen



1 x Uponor RS Albue 90°



2 x Uponor RS Overgang 40-110 MLC

Uponor Reduksjonsmuffe MLC

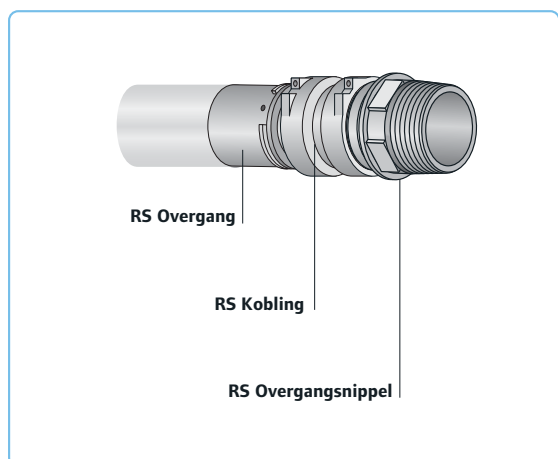

Nødvendige deler til denne forbindelsen



1 x Uponor RS Kobling



1 Uponor RS Overgang 40-110 MLC



1 Uponor RS Overgangsnippel

Kobling

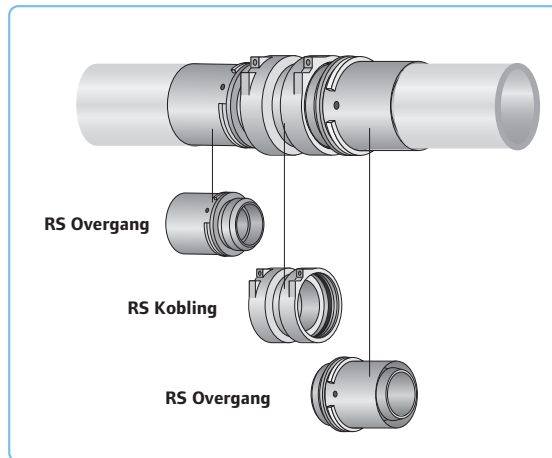

Nødvendige deler til denne forbindelsen



Kobling reduksjon, 75-110

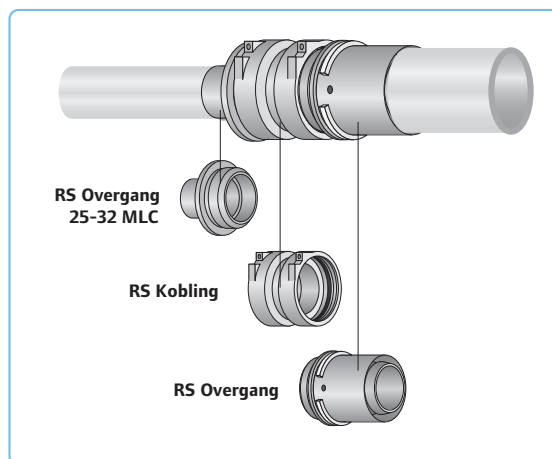

Nødvendige deler til denne forbindelsen



Kobling reduksjon, 110 - 25

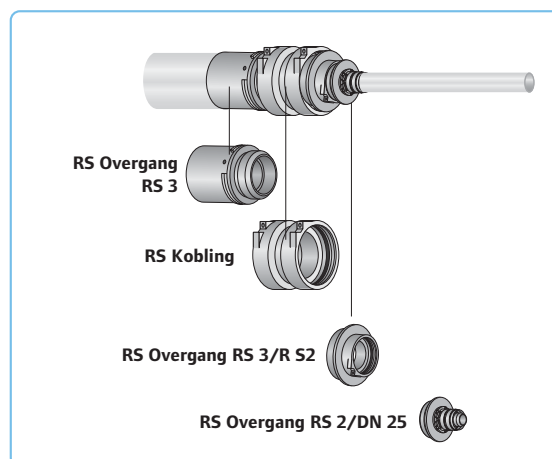









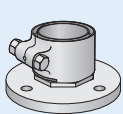

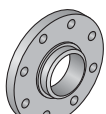
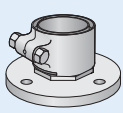

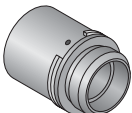
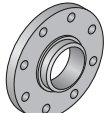
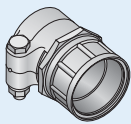

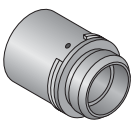
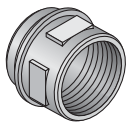
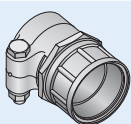
Nødvendige deler til denne forbindelsen

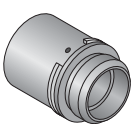
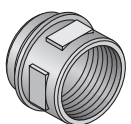
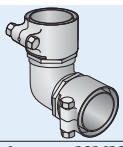

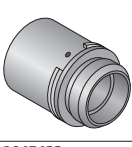
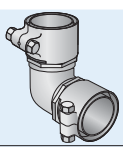

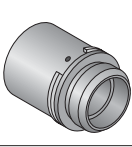
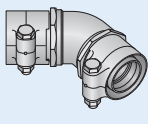
Konverteringsliste

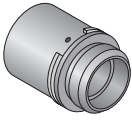
Uponor Pressfittings MLC - Uponor MLC Modulsystem 63 -110 mm

Gammel	Ny		
			
Art nr: 1014299	1045441 5079068	1045423 5079048	1045425 5074051
Uponor overgang til flens MLC DN 80-90x8,5	1 x Uponor RS Kobling RS 3	1 x Uponor RS Overgang RS 3/90	1 x Uponor RS Flens RS 3/DN 80
			
Art nr: 1014300	1045441 5079068	1045424 5079049	1045426 5079052
Uponor overgang til flens MLC DN 100-110x10	1 x Uponor RS Kobling RS 3	1 x Uponor RS Overgang RS 3/110	1 x Uponor RS Flens RS 3/DN 100
			
Art nr: 1014185	1045441 5079068	1045423 5079048	1045433 5079059
Uponor Klemringskobling m/muffe MLC 90x3"	1 x Uponor RS Kobling RS 3	1 x Uponor RS Overgang RS 3/90	1 x Uponor RS Overgangsmuffe RS 3/Rp 3
			
Art nr: 1014187	1045441 5079068	1045424 5079049	1045433 5079059
Uponor Klemringskobling m/muffe MLC 110x3"	1 x Uponor RS Kobling RS 3	1 x Uponor RS Overgang RS 3/110	1 x Uponor RS Overgangsmuffe RS 3/Rp 3
			
Art nr: 1014190	1045435 5079062	1045423 5079048	
Uponor Klemringsalbue MLC 90-90	1x Uponor RS Albue RS 3	2 x Uponor RS Overgang RS 3/90	
			
Art nr: 1014191	1045435 5079062	1045424 5079049	
Uponor Klemringsalbue MLC 110-110	1x Uponor RS Albue RS 3	2 x Uponor RS Overgang RS 3/110	
			
Art nr: 1014194	1045437 5079064	1045423 5079048	
Uponor Klemringsalbue MLC 45Gr 90-9	1 x Uponor RS Albue 45° RS 3	2 x Uponor RS Overgang RS 3/90	



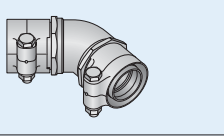
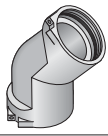
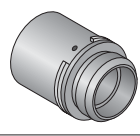
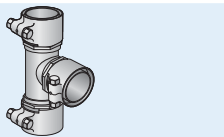
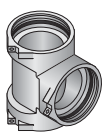
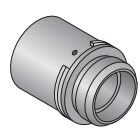
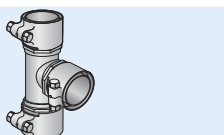
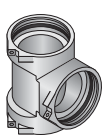
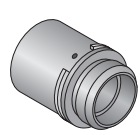
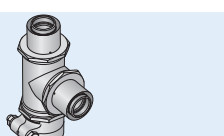
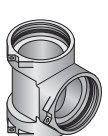
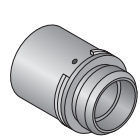
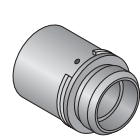
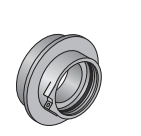
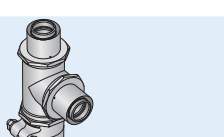
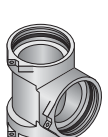
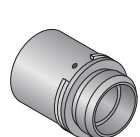
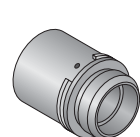
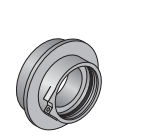
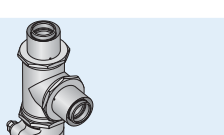
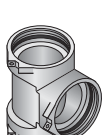
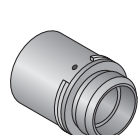
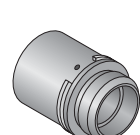
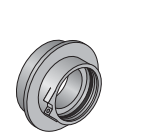

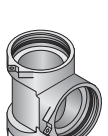
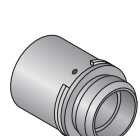
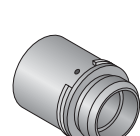
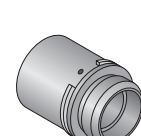
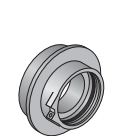





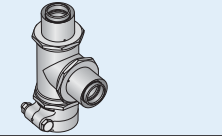

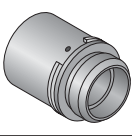
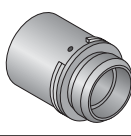
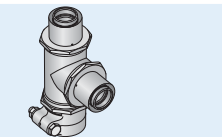

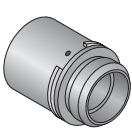
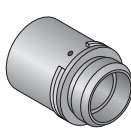

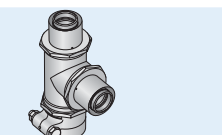

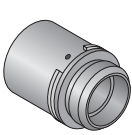
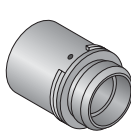
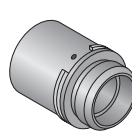

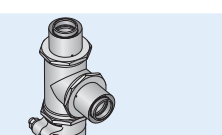

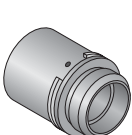
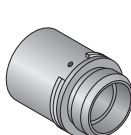
Konverteringsliste

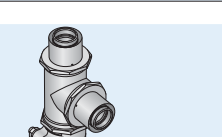
Uponor Pressfittings MLC - Uponor MLC Modulsystem 63 -110 mm

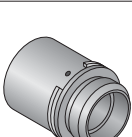
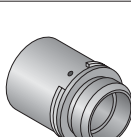
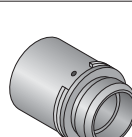
Gammel	Ny				
 <p>Art nr: 1014195</p> <p>Uponor Klemringsalbue MLC 45Gr 110-110</p>	 <p>1045437 5079064</p> <p>1 x Uponor RS Albue 45° RS 3</p>	 <p>1045424 5079049</p> <p>2 x Uponor RS Overgang RS 3/110</p>			
 <p>Art nr: 1014228</p> <p>Uponor Klemrings T-rør 90-90-90</p>	 <p>1045439 5079066</p> <p>1 x Uponor RS T-rør RS 3</p>	 <p>1045423 5079048</p> <p>3 x Uponor RS Overgang RS 3/90</p>			
 <p>Art nr: 1014250</p> <p>Uponor Klemrings T-rør MLC 110-110-110</p>	 <p>1045439 5079066</p> <p>1 x Uponor RS T-rør RS 3</p>	 <p>1045424 5079049</p> <p>3 x Uponor RS Overgang RS 3/110</p>			
 <p>Art nr: 1014234</p> <p>Uponor Klemrings T-rør red. MLC 90-75-75</p>	 <p>1045439 5079066</p> <p>1 x Uponor RS T-rør RS 3</p>	 <p>1045423 5079048</p> <p>1 x Uponor RS Overgang RS 3/90</p>	 <p>1045422 5079047</p> <p>2 x Uponor RS Overgang RS 2/75</p>	 <p>1045442 5079069</p> <p>2 x Uponor RS Overgang RS 3/RS 2</p>	
 <p>Art nr: 1014230</p> <p>Uponor Klemrings T-rør red. MLC 90-75-90</p>	 <p>1045439 5079066</p> <p>1 x Uponor RS T-rør RS 3</p>	 <p>1045423 5079048</p> <p>2 x Uponor RS Overgang RS 3/90</p>	 <p>1045422 5079047</p> <p>1 x Uponor RS Overgang RS 2/75</p>	 <p>1045442 5079069</p> <p>1 x Uponor RS Overgang RS 3/RS 2</p>	
 <p>Art nr: 1014233</p> <p>Uponor Klemrings T-rør red. MLC 90-90-75</p>	 <p>1045439 5079066</p> <p>1 x Uponor RS T-rør RS 3</p>	 <p>1045423 5079048</p> <p>2 x Uponor RS Overgang RS 3/90</p>	 <p>1045422 5079047</p> <p>1 x Uponor RS Overgang RS 2/75</p>	 <p>1045442 5079069</p> <p>1 x Uponor RS Overgang RS 3/RS 2</p>	
 <p>Art nr: 1014237</p> <p>Uponor Klemrings T-rør red. MLC 90-110-75</p>	 <p>1045439 5079066</p> <p>1 x Uponor RS T-rør RS 3</p>	 <p>1045423 5079048</p> <p>1 x Uponor RS Overgang RS 3/90</p>	 <p>1045424 5079049</p> <p>1 x Uponor RS Overgang RS 3/110</p>	 <p>1045422 5079047</p> <p>1 x Uponor RS Overgang RS 2/75</p>	 <p>1045442 5079069</p> <p>1 x Uponor RS Overgang RS 3/RS 2</p>

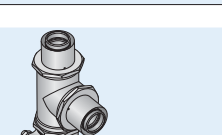

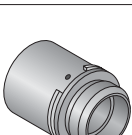
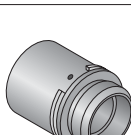
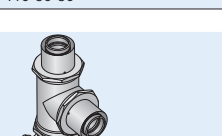
Konverteringsliste

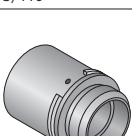
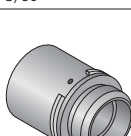
Uponor Pressfittings MLC - Uponor MLC Modulsystem 63 -110 mm

Gammel	Ny				
					
Art nr: 1014240	1045439 5079066	1045423 5079048	1045424 5079049		
Uponor Klemrings T-rør red. MLC 90-110-90	1 x Uponor RS T-rør RS 3	2 x Uponor RS Overgang RS 3/90	1 x Uponor RS Overgang RS 3/110		
					
Art nr: 1014262	1045439 5079066	1045424 5079049	1045422 5079047	1045442 5079069	
Uponor Klemrings T-rør red. MLC 110-75-75	1 x Uponor RS T-rør RS 3	1 x Uponor RS Overgang RS 3/110	2 x Uponor RS Overgang RS 2/75	2 x Uponor RS, Overgang RS 3/RS 2	
					
Art nr: 1014268	1045439 5079066	1045424 5079049	1045422 5079047	1045423 5079048	1045442 5079069
Uponor Klemrings T-rør red. MLC 110-75-90	1 x Uponor RS T-rør RS 3	1 x Uponor RS Overgang RS 3/110	1 x Uponor RS Overgang RS 2/75	1 x Uponor RS Overgang RS 3/90	1 x Uponor RS Overgang RS 3/RS 2
					
Art nr: 1014254	1045439 5079066	1045424 5079049	1045422 5079047	1045442 5079069	
Uponor Klemrings T-rør red. MLC 110-75-110	1 x Uponor RS T-rør RS 3	2 x Uponor RS Overgang RS 3/110	1 x Uponor RS Overgang RS 2/75	1 x Uponor RS Overgang RS 3/RS 2	
					
Art nr: 1014267	1045439 5079066	1045424 5079049	1045423 5079048	1045422 5079047	1045442 5079069
Uponor Klemrings T-rør red. MLC 110-90-75	1 x Uponor RS T-rør RS 3	1 x Uponor RS Overgang RS 3/110	1 x Uponor RS Overgang RS 3/90	1 x Uponor RS Overgang RS 2/75	1 x Uponor RS Overgang RS 3/RS 2
					
Art nr: 1014266	1045439 5079066	1045424 5079049	1045423 5079048		
Uponor Klemrings T-rør red. MLC 110-90-90	1 x Uponor RS T-rør RS 3	1 x Uponor RS Overgang RS 3/110	2 x Uponor RS Overgang RS 3/90		
					
Art nr: 1014257	1045439 5079066	1045424 5079049	1045423 5079048		
Uponor T-rør red. MLC 110-110	1 x Uponor RS T-rør RS 3	2x Uponor RS Overgang RS 3/110	1 x Uponor RS Overgang RS 3/90		



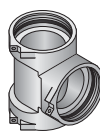
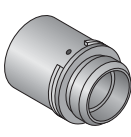
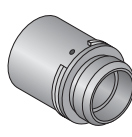
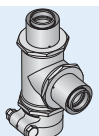
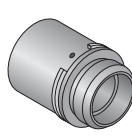
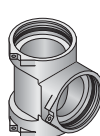
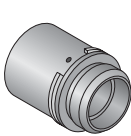
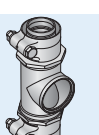

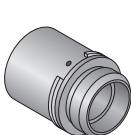
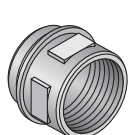
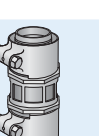
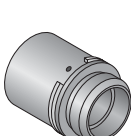
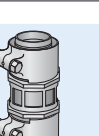
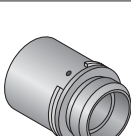
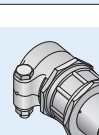
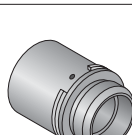
Konverteringsliste

Uponor Pressfittings MLC - Uponor MLC Modulsystem 63 -110 mm

Gammel	Ny			
 <p>Art nr: 1014259</p> <p>Uponor Klemrings T-rør red. MLC 110-110-75</p>	 <p>1045439 5079066</p> <p>1 x Uponor RS T-rør RS 3</p>	 <p>1045424 5079049</p> <p>2 x Uponor RS Overgang RS 3/110</p>	 <p>1045422 5079047</p> <p>1 x Uponor RS Overgang RS 2/75</p>	 <p>1045442 5079069</p> <p>1 x Uponor RS Overgang RS 3/RS 2</p>
 <p>Art nr: 1014264</p> <p>Uponor Klemrings T-rør red. MLC 110-110-90</p>	 <p>1045439 5079066</p> <p>1 x Uponor RS T-rør RS 3</p>	 <p>1045424 5079049</p> <p>2 x Uponor RS Overgang RS 3/110</p>	 <p>1045423 5079048</p> <p>1 x Uponor RS Overgang RS 3/90</p>	
 <p>Art nr: 1014301</p> <p>Uponor Klemrings T-rør m/muffe MLC 90-Rp3-90</p>	 <p>1045439 5079066</p> <p>1 x Uponor RS T-rør RS 3</p>	 <p>1045423 5079048</p> <p>2 x Uponor RS Overgang RS 3/90</p>	 <p>1045433 5079059</p> <p>1 x Uponor RS Overgangsmuffe RS 3/Rp 3</p>	
 <p>Art nr: 1014302</p> <p>Uponor Klemrings T-rør m/muffe MLC 110-Rp3-110</p>	 <p>1045439 5079066</p> <p>1 x Uponor RS T-rør RS 3</p>	 <p>1045424 5079049</p> <p>2 x Uponor RS Overgang RS 3/110</p>	 <p>1045433 5079059</p> <p>1 x Uponor RS Overgangsmuffe RS 3/Rp 3</p>	
 <p>Art nr: 1014286</p> <p>Uponor Klemringsmuffe MLC 90-90</p>	 <p>1045441 5079068</p> <p>1 x Uponor RS Kobling RS 3</p>	 <p>1045423 5079048</p> <p>2 x Uponor RS Overgang RS 3/90</p>		
 <p>Art nr: 1014288</p> <p>Uponor Klemringsmuffe MLC 110-110</p>	 <p>1045441 5079068</p> <p>1 x Uponor RS Kobling RS 3</p>	 <p>1045424 5079049</p> <p>2 x Uponor RS Overgang RS 3/110</p>		
 <p>Art nr: 1014287</p> <p>Uponor Klemringsmuffe red. MLC 90-75</p>	 <p>1045441 5079068</p> <p>1 x Uponor RS Kobling RS 3</p>	 <p>1045423 5079048</p> <p>1 x Uponor RS Overgang RS 3/90</p>	 <p>1045422 5079047</p> <p>1 x Uponor RS Overgang RS 2/75</p>	 <p>1045442 5079069</p> <p>1 x Uponor RS Overgang RS 3/RS 2</p>

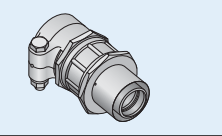
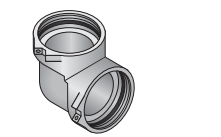
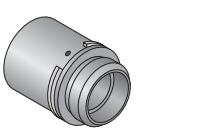
Konverteringsliste

Uponor Pressfittings MLC - Uponor MLC Modulsystem 63 -110 mm

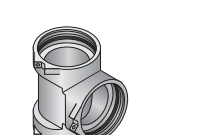
Gammel	Ny		
 <p>Art nr: 1014289</p> <p>Uponor Klemringsmuffe red. MLC 110-90</p>	 <p>1045441 5079068</p> <p>1 x Uponor RS Kobling RS 3</p>	 <p>1045424 5079049</p> <p>1 x Uponor RS Overgang RS 3/110</p>	 <p>1045423 5079048</p> <p>1 x Uponor RS Overgang RS 3/90</p>
 <p>Art nr: 1014189 NRF nr: 5071538</p> <p>Uponor Albue MLC 75-75</p>	 <p>1045434 5079061</p> <p>1 x Uponor RS Albue RS 2</p>	 <p>1045422 5079047</p> <p>2 x Uponor RS Overgang RS 2/75</p>	
 <p>Art nr: 1014188</p> <p>Uponor Albue MLC 63-63</p>	 <p>1045434 5079061</p> <p>1 x Uponor RS Albue RS 2</p>	 <p>1045421 5079046</p> <p>2 x Uponor RS Overgang RS 2/63</p>	
 <p>Art nr: 1014193</p> <p>Uponor Albue MLC 45° 75-75</p>	 <p>1045436 5079063</p> <p>1 x Uponor RS Albue 45° RS 2</p>	 <p>1045422 5079047</p> <p>2 x Uponor RS Overgang RS 2/75</p>	
 <p>Art nr: 1014192</p> <p>Uponor Albue MLC 45° 63-63</p>	 <p>1045436 5079063</p> <p>1 x Uponor RS Albue 45° RS 2</p>	 <p>1045421 5079046</p> <p>2 x Uponor RS Overgang RS 2/63</p>	
 <p>Art nr: 1014214</p> <p>Uponor T-rør MLC 75-Rp1-75</p>	 <p>1045438 5079065</p> <p>1 x Uponor RS T-rør RS 2</p>	 <p>1045422 5079047</p> <p>2 x Uponor RS Overgang RS 2/75</p>	 <p>1045430 5079056</p> <p>1 x Uponor RS Overgangsmuffe RS 2/Rp 1</p>
 <p>Art nr: 1014205</p> <p>Uponor T-rør MLC 63-Rp1-63</p>	 <p>1045438 5079065</p> <p>1 x Uponor RS T-rør RS 2</p>	 <p>1045421 5079046</p> <p>2 x Uponor RS Overgang RS 2/63</p>	 <p>1045430 5079056</p> <p>1 x Uponor RS Overgangsmuffe RS 2/Rp 1</p>











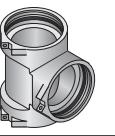
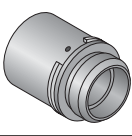

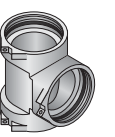
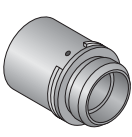
Konverteringsliste

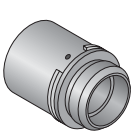
Uponor Pressfittings MLC - Uponor MLC Modulsystem 63 -110 mm

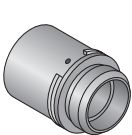
Gammel	Ny			
 <p>Art nr: 1014211</p> <p>Uponor T-rør MLC 75-75-75</p>	 <p>1045438 5079065</p> <p>1 x Uponor RS T-rør RS 2</p>	 <p>1045422 5079047</p> <p>3 x Uponor RS Overgang RS 2/75</p>		
 <p>Art nr: 1011498</p> <p>Uponor T-rør MLC 63-63-63</p>	 <p>1045438 5079065</p> <p>1 x Uponor RS T-rør RS 2</p>	 <p>1045421 5079046</p> <p>3 x Uponor RS Overgang RS 2/63</p>		
 <p>Art nr: 1014212</p> <p>Uponor T-rør red. MLC 75-50-75</p>	 <p>1045438 5079065</p> <p>1 x Uponor RS T-rør RS 2</p>	 <p>1045422 5079047</p> <p>2 x Uponor RS Overgang RS 2/75</p>	 <p>1045420 5079045</p> <p>1 x Uponor RS Overgang RS 2/50</p>	
 <p>Art nr: 1014213</p> <p>Uponor T-rør red. MLC 75-40-75</p>	 <p>1045438 5079065</p> <p>1 x Uponor RS T-rør RS 2</p>	 <p>1045422 5079047</p> <p>2 x Uponor RS Overgang RS 2/75</p>	 <p>1045419 5079044</p> <p>1 x Uponor RS Overgang RS 2/40</p>	
 <p>Art nr: 1014199</p> <p>Uponor T-rør red. MLC 63-40-63</p>	 <p>1045438 5079065</p> <p>1 x Uponor RS T-rør RS 2</p>	 <p>1045421 5079046</p> <p>2 x Uponor RS Overgang RS 2/63</p>	 <p>1045419 5079044</p> <p>1 x Uponor RS Overgang RS 2/40</p>	
 <p>Art nr: 1014201</p> <p>Uponor T-rør red. MLC 63-32-63</p>	 <p>1045438 5079065</p> <p>1 x Uponor RS T-rør RS 2</p>	 <p>1045421 5079046</p> <p>2 x Uponor RS Overgang RS 2/63</p>	 <p>1045418 5079043</p> <p>1 x Uponor RS Overgang RS 2/32</p>	
 <p>Art nr: 1014216</p> <p>Uponor T-rør red. MLC 75-25-63</p>	 <p>1045438 5079065</p> <p>1 x Uponor RS T-rør RS 2</p>	 <p>1045422 5079047</p> <p>1 x Uponor RS Overgang RS 2/75</p>	 <p>1045417 5079042</p> <p>1 x Uponor RS Overgang RS 2/25</p>	 <p>1045421 5079046</p> <p>1 x Uponor RS Overgang RS 2/63</p>

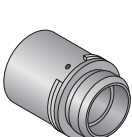
Konverteringsliste

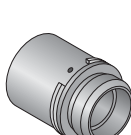
Uponor Pressfittings MLC - Uponor MLC Modulsystem 63 -110 mm

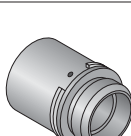
Gammel	Ny			
 <p>Art nr: 1014200</p> <p>Uponor T-rør red. MLC 63-25-63</p>	 <p>1045438 5079065</p> <p>1 x Uponor RS T-rør RS 2</p>	 <p>1045421 5079046</p> <p>2 x Uponor RS Overgang RS 2/63</p>	 <p>1045417 5079042</p> <p>1 x Uponor RS Overgang RS 2/25</p>	
 <p>Art nr: 1014203</p> <p>Uponor T-rør red. MLC 63-25-50</p>	 <p>1045438 5079065</p> <p>1 x Uponor RS T-rør RS 2</p>	 <p>1045421 5079046</p> <p>1 x Uponor RS Overgang RS 2/63</p>	 <p>1045417 5079042</p> <p>1 x Uponor RS Overgang RS 2/25</p>	 <p>1045420 5079045</p> <p>1 x Uponor RS Overgang RS 2/50</p>
 <p>Art nr: 1014282 5071705</p> <p>Uponor muffe MLC 75-75</p>	 <p>1045440 5079067</p> <p>1 x Uponor RS Kobling RS 2</p>	 <p>1045422 5079047</p> <p>2 x Uponor RS Overgang RS 2/75</p>		
 <p>Art nr: 1014271</p> <p>Uponor muffe MLC 63-63</p>	 <p>1045440 5079067</p> <p>1 x Uponor RS Kobling RS 2</p>	 <p>1045421 5079046</p> <p>2 x Uponor RS Overgang RS 2/63</p>		
 <p>Art nr: 1014283</p> <p>Uponor muffe red. MLC 75-63</p>	 <p>1045440 5079067</p> <p>1 x Uponor RS Kobling RS 2</p>	 <p>1045422 5079047</p> <p>1 x Uponor RS Overgang RS 2/75</p>	 <p>1045421 5079046</p> <p>1 x Uponor RS Overgang RS 2/63</p>	
 <p>Art nr: 1014284</p> <p>Uponor muffe red. MLC 75-50</p>	 <p>1045440 5079067</p> <p>1 x Uponor RS Kobling RS 2</p>	 <p>1045422 5079047</p> <p>1 x Uponor RS Overgang RS 2/75</p>	 <p>1045420 5079045</p> <p>1 x Uponor RS Overgang RS 2/50</p>	
 <p>Art nr: 1014275</p> <p>Uponor muffe red. MLC 63-50</p>	 <p>1045440 5079067</p> <p>1 x Uponor RS Kobling RS 2</p>	 <p>1045421 5079046</p> <p>1 x Uponor RS Overgang RS 2/63</p>	 <p>1045420 5079045</p> <p>1 x Uponor RS Overgang RS 2/50</p>	

Konverteringsliste

Uponor Pressfittings MLC - Uponor MLC Modulsystem 63 -110 mm

Gammel	Ny		
			
Art nr: 1014285	1045440 5079067	1045422 5079047	1045419 5079044
Uponor mufte red. MLC 75-40	1 x Uponor RS Kobling RS 2	1 x Uponor RS Overgang RS 2/75	1 x Uponor RS Overgang RS 2/40
			
Art nr: 1014279	1045440 5079067	1045421 5079046	1045419 5079044
Uponor mufte red. MLC 63-40	1 x Uponor RS Kobling RS 2	1 x Uponor RS Overgang RS 2/63	1 x Uponor RS Overgang RS 2/40
			
Art nr: 1014182	1045440 5079067	1045422 5079047	1045432 5079058
Uponor mufte red. MLC 75-Rp2½	1 x Uponor RS Kobling RS 2	1 x Uponor RS Overgang RS 2/75	1 x Uponor RS Overgangsmuffe RS 2/Rp 2½
			
Art nr: 1014178	1045440 5079067	1045421 5079046	1045431 5079057
Uponor mufte red. MLC 63-Rp2	1 x Uponor RS Kobling RS 2	1 x Uponor RS Overgang RS 2/63	1 x Uponor RS Overgangsmuffe RS 2/Rp 2
			
Art nr: 1014180	1045440 5079067	1045422 5079047	1045428 5079054
Uponor nippel red. MLC 75-R2	1 x Uponor RS Kobling RS 2	1 x Uponor RS Overgang RS 2/75	1 x Uponor RS Overgangsnippel RS 2/ R 2½
			
Art nr: 1014174	1045440 5079067	1045421 5079046	1045427 5079053
Uponor nippel red. MLC 63-R2	1 x Uponor RS Kobling RS 2	1 x Uponor RS Overgang RS 2/63	1 x Uponor RS Overgangsnippel RS 2/R 2

Uponor AS forbeholder seg retten til å endre spesifikasjonene på tilhørende komponenter i samsvar med sin policy om kontinuerlig forbedring og produktutvikling uten forhåndsvarsel.

Uponor AS
Uponor VVS
Postboks 23
Støttumveien 7
1541 Vestby

T 64 95 66 00
F 64 95 31 20
W www.uponor.no

Uponor