

S

GB

PURUS

RSK 807 56 28

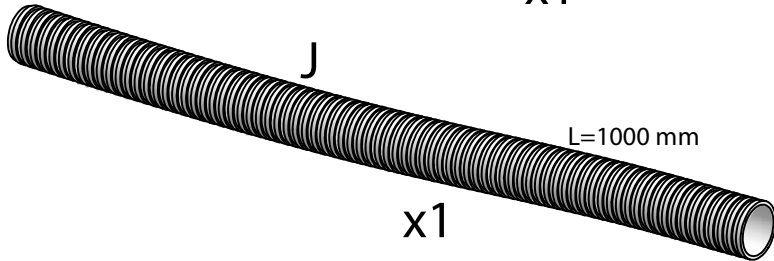
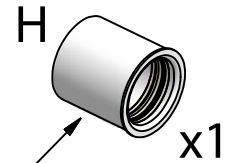
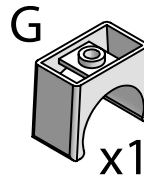
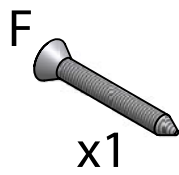
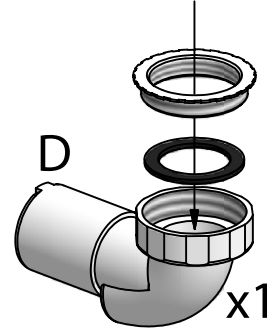
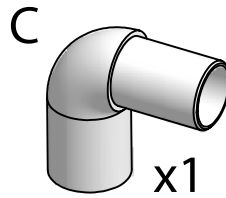
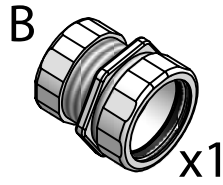
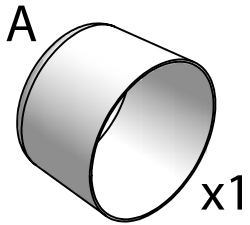

S För 40 mm anslutning
GB For 40 mm connection

1

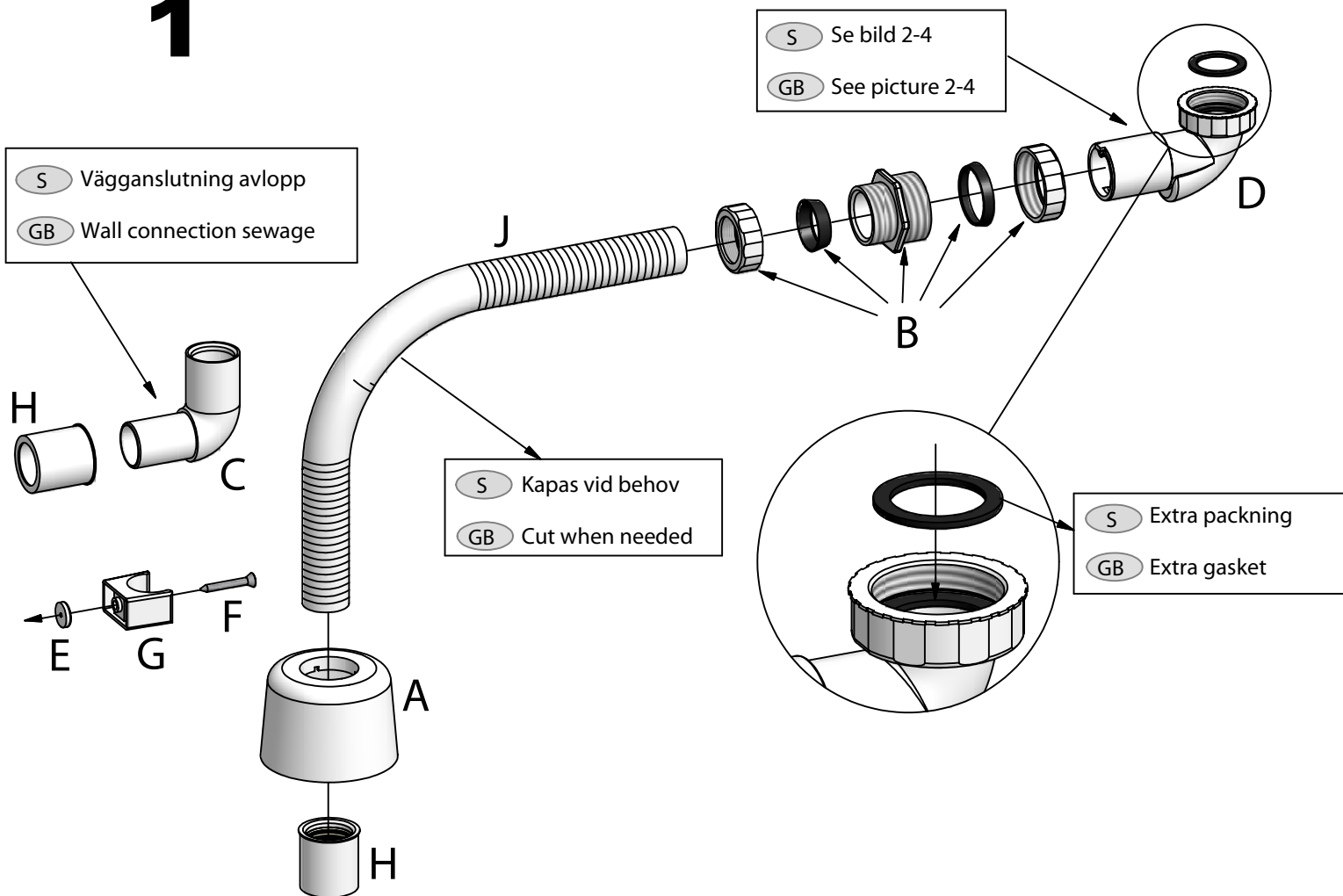

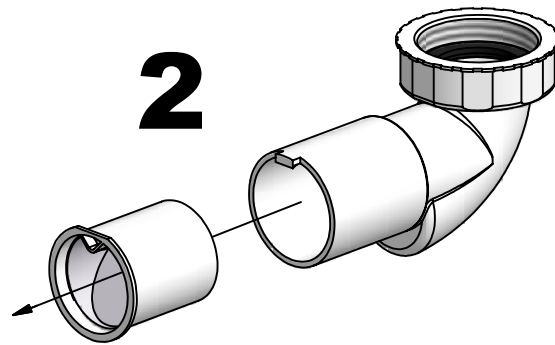

3

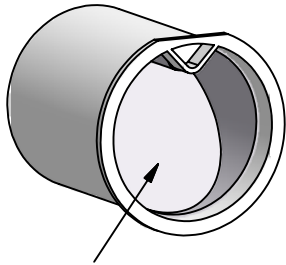

S Membran i rätt position

GB Membrane in right position

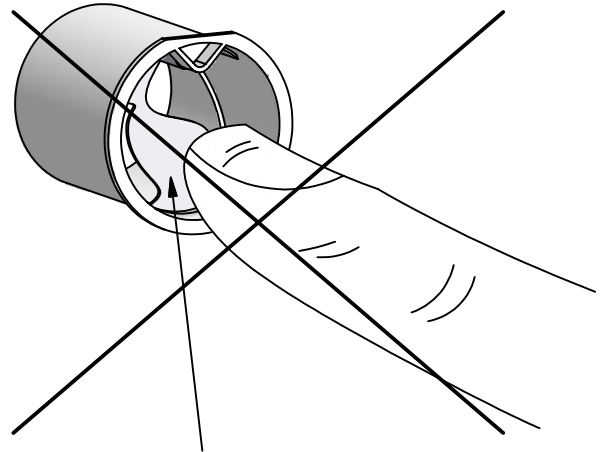

S Membran i fel position

GB Membrane in wrong position

S **OBS:** För att luktlåset ska fungera är det av yttersta vikt att membranet ligger an i sin rätta position i hållaren. Exempelvis genom att peta med ett finger på membranet riskerar man att membranet kan deformeras eller fastna inuti sin hållare, varvid avloppslukt kan uppstå. Säkerställ att membranet har sin rätta position efter isärtagande, rengöring etc.

GB **Note:** It's imperative that the membrane are located in its right position in order to prevent smell from the sewage. Avoid pressing finger on the membrane as the membrane can be deformed or get stuck into its holder and the smell can occur. Secure that the membrane is in its right position after disassembling, cleansing etc!

4

