

### Basic Information

For best result, and validity of the guarantee, these instructions should be followed carefully.

Regarding the content of natural wood based material used in Pergo floors there is a natural preference to expand and contract as a result of its hygroscopic properties. As a result of these properties the flooring should be installed floating, meaning that it is allowed to move in any direction having enough space to all walls or any fixed objects.

This has to be taken in consideration when planning area size, area geometry, furnishing etc.

The ideal indoor climatic conditions are 18-22°C and 50-60% RH. Largest recommended installation area is 10X10m.

### General Information

The floor should be a floating installation i.e. not screwed, glued or stapled down. Heavy furnished rooms might require the floor area to be split into smaller areas by using T-mouldings.



Store your Pergo floor flat and in unopened packages at normal room temperature and relative humidity for at least 48 hours prior to installation. Allowing the flooring that has been subjected to cold temperatures to acclimate to room temperature.

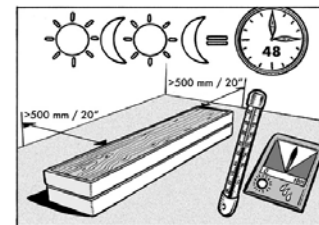

It is important to leave an expansion gap around the total perimeter of the floor and around columns, pipes, thresholds, etc.

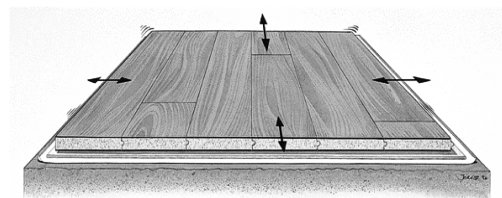

Do not install the floor in wet or damp rooms, such as bathrooms or rooms with a floor drain.



Always use Pergo Accessories for perfect result. Ensure that an effective doormat is placed at the entrance. It is recommended to use feet of plastic or stainless steel which does not collect dirt or similar. Office chairs with wheels should be equipped with soft wheels. Damp mop the floor when needed. Use Pergo Laminate and Wood Floor Cleaner and Pergo microfiber mop.

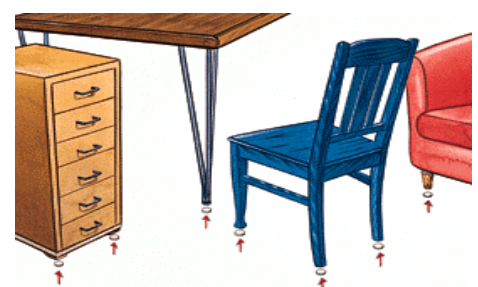

### Preparation before Installation

The subfloor must be even, dry and clean.

Pergo can be installed on top of wood, vinyl, linoleum, and ceramic tiles.

For wooden floors, check that any loose floorboards is securely fixed. Remove textile floorings, underlay and glue residues' before installing.

If you have under floor heating, see separate information.

Coverage is not allowed to be taped down

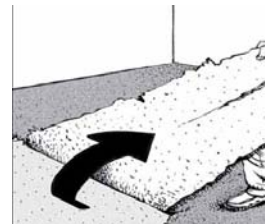
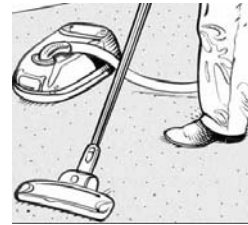

### Tolerances for evenness

Maximum 3 mm of 2 m length and additional 1,2 mm of 0,25 m length

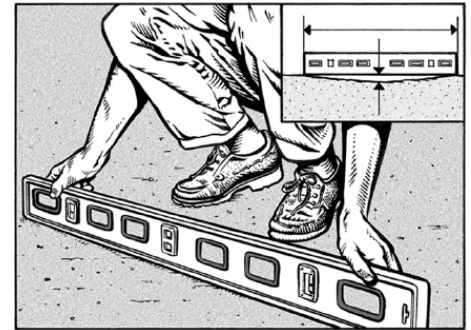

### Moisture content

Always install a 0,2 mm polyethylene film with an overlap of 200 mm. on slab/screed/concrete floors - including those with vinyl or ceramic tiles installed – or floors with under floor heating system, Maximum moisture content in the slab/screed/concrete floors is 75% RH at min 18°C

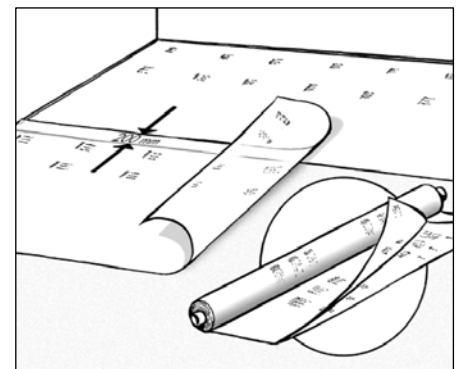

### Expansion gap

An expansion gap of approx 5 mm around the total perimeter of the floor and around columns, pipes, and thresholds etc.

An expansion profile (T-moulding) must be used in door openings, angled rooms, corners in corridors and/or if the floorings are longer than 10 meters.

Longer/wider floorings might be possible, contact Pergo.

Check that the floor panel is without defects before installing.

After 2-3 packages of installation you will see a representative visual design of the entire floor.

Some of the products have bevelled edges on 2 or 4 sides. They will give a more distinct pattern

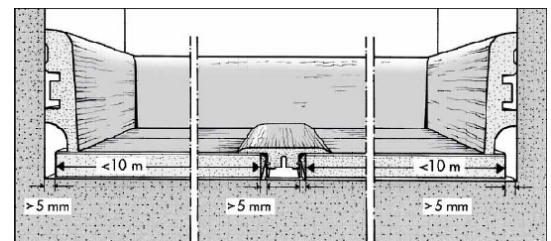

Generally, the best if it is installed parallel to the length of the room or so that incoming light falls along the length of the planks. flooring will look

By using the off-cut piece (has to be longer than 300 mm) this will be most preferred installation pattern.

You can also use the multi-plank displacement installation technique, starting with cutting one plank in  $\frac{2}{3}$  and one in  $\frac{1}{3}$  of the length. This will create a  $\frac{1}{3}$  step pattern.

Using a half-plank displacement installation technique you start with cutting one plank in half. In both cases you need to make sure, during the installation that the short sides joints lines up perfectly.

Measure the room width and make sure that the last row will be bigger than 50mm. If not, you have to cut the first plank row and balance the width of these two rows so no one is smaller than 50 mm.

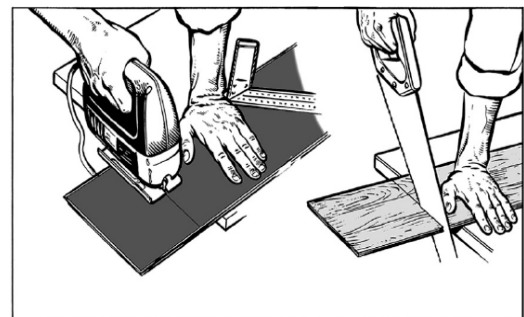
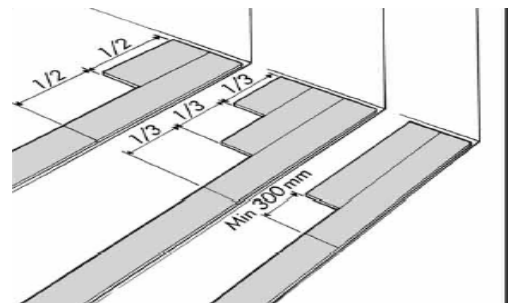
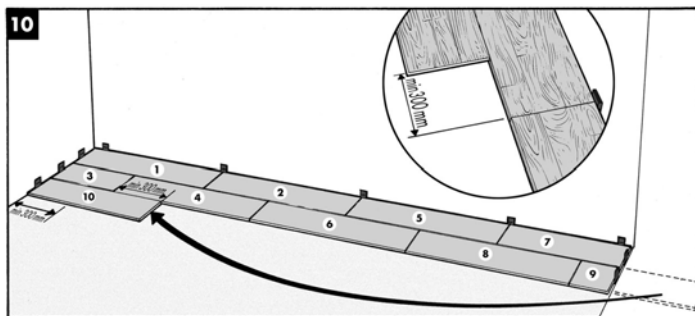

### Assembly Preparation

Start the installation in the left-hand corner with the tongue facing the wall. The joint is designed for a installation from left to right. The recommended installation method is to install with the tongue into the groove. Only in few situations you need to fit the groove on the tongue. Remove the tongue facing the wall. Assemble the planks together in the first row so that they form a straight line.

**Note: In order to disassemble the PerfectFold joint you must slide the planks apart. Do not lift the plank.**

If the starting wall is uneven or you need to scribe the contour of the wall on the panels in the first row, disassemble and cut. Check that the distance between the first row and the wall is correct, min 5 mm and use spacers in both short side and on long side.

Make sure that on long side have a spacer at each short side joint and at least one in the middle of the plank.

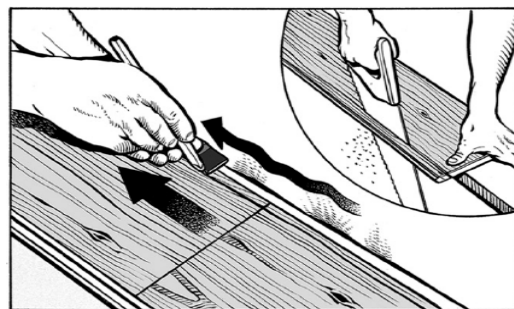
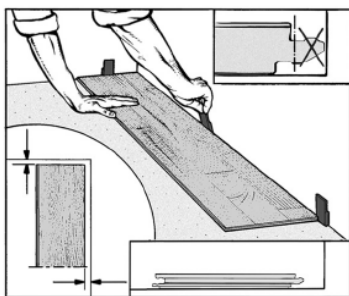

Put the first plank in the next row in place. Take the next plank. Place it on the subfloor and push it into the long side joint. Angle the plank a little bit so the tongue enters the groove. Slide the plank in place over the end joint and press it firmly down.

**Note: In order to disassemble the PerfectFold joint you must slide the planks apart. The complete row has to be removed in order to be able to slide the planks apart.**

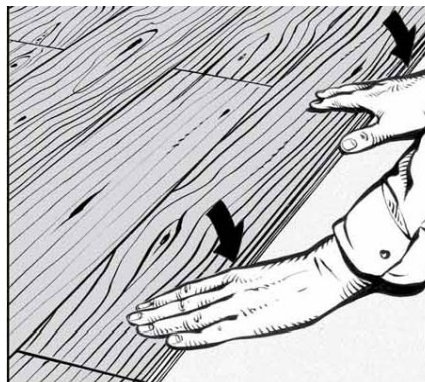
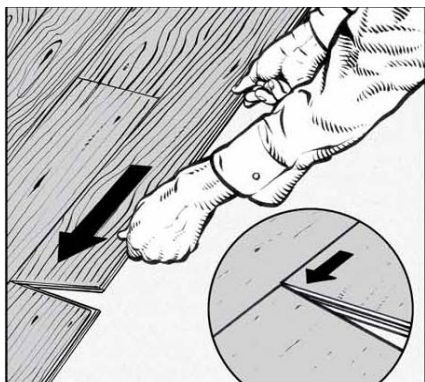
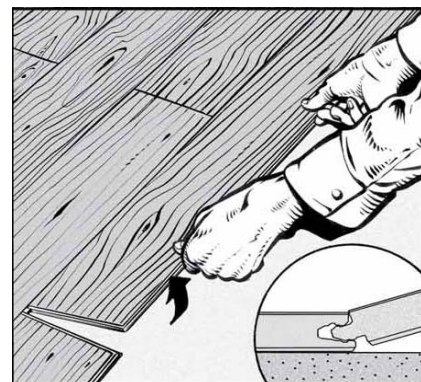
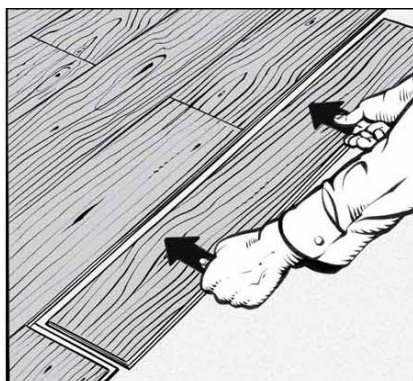
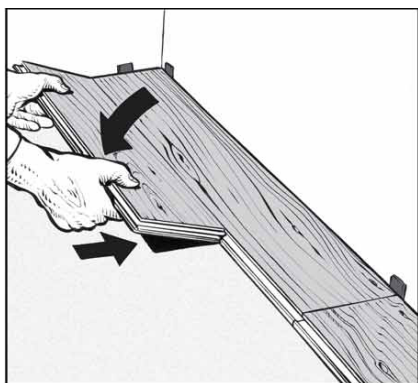

### Door Lining

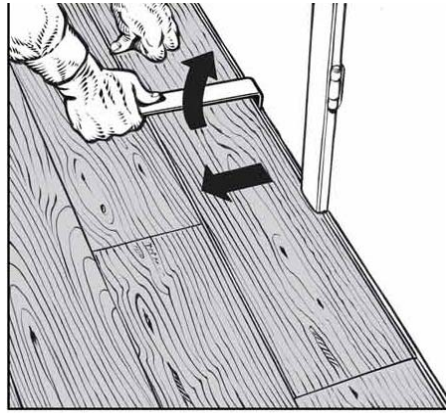
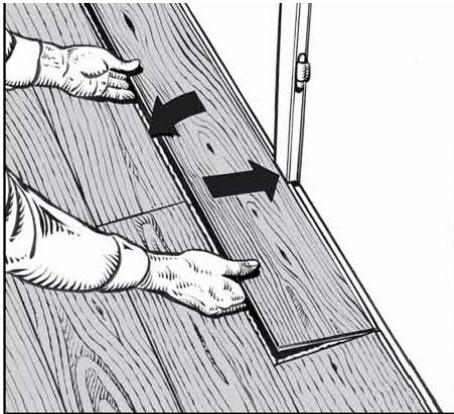

To calculate the correct width of the last row. Place a full row of tiles directly on top of the last installed row of full tiles. Use the full width of a scrap piece of tile. Place the tongue side against the wall and the pencil against the extended groove and mark a line the length of the wall. Cut along the pencil line.

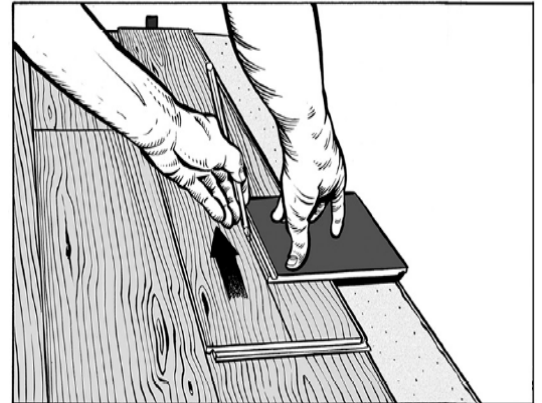

If you have pipes coming through, take all measurements and drill a hole minimum 15 mm bigger than the pipe diameter. Cut the plank according to illustration if it is on the long or short side.

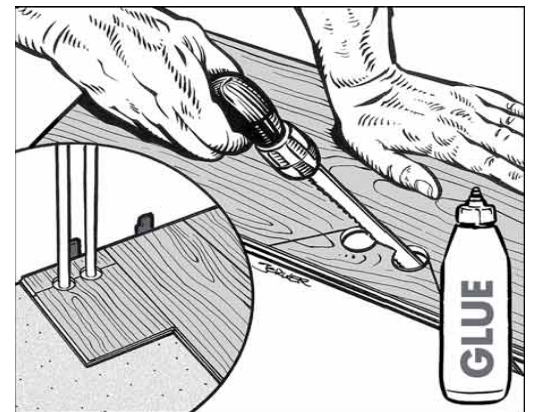

### Finishing up

Remove all spacers before placing skirting's. Never use silicone or other compounds that will fix/glue down the skirting's, metal frames or such at the floor. Make sure the floor could move underneath skirting's.