



ZAVOD ZA
GRADBENIŠTVO
SLOVENIJE

SLOVENIAN
NATIONAL BUILDING
AND CIVIL ENGINEERING
INSTITUTE



član EOTA
Member of EOTA

Dimičeva 12
1000 Ljubljana, Slovenija
Tel.: +386 (0)1-280 44 72, 280 45 37
Fax: +386 (0)1-280 44 84
E-pošta: info.ta@zag.si
http://www.zag.si

European Technical Assessment

ETA-16/0823
of 8. 12. 2016

English version prepared by ZAG

I GENERAL PART

**Organ za tehnično ocenjevanje, ki je izdal
ETA**

Technical Assessment Body issuing the ETA

ZAG Ljubljana

Komercialno ime gradbenega proizvoda

Trade name of the construction product

**MFT EKSPANSJONBOLT SYREFAST
A4 OP.1**

**Družina proizvoda, ki ji gradbeni proizvod
pripada**

Product family to which the construction product belongs

**Torzijsko kontrolirano zatezno nerjaveče
kovinsko sidro velikosti M8, M10, M12 in
M16 za vgradnjo v beton**

*Torque controlled expansion anchor made of
stainless steel of sizes M8, M10, M12 and M16 for
use in concrete*

Proizvajalec

Manufacturer

**HITACHI POWER TOOLS NORWAY AS
Kjeller Vest 7
2007 KJELLER
NORWAY**

Proizvodni obrat

Manufacturing plant

**HITACHI POWER TOOLS NORWAY AS
Plant No°1 (Italy)**

Ta Evropska tehnična ocena vsebuje

This European Technical Assessment contains

12 strani vključno s 9 prilogami, ki so
sestavni del te ocene

*12 pages including 9 annexes, which form an integral
part of the document*

**Ta Evropska tehnična ocena je izdana na
podlagi Uredbe (EU) št. 305/2011 na osnovi**

*This European Technical Assessment is issued in
according to Regulation (EU) No 305/2011, on the basis
of*

Smernice za evropska tehnična soglasja
ETAG 001 – del 1 in 2, izdaja 2013, ki se
uporablja kot EAD

*Guideline for European Technical Approval ETAG
001 – part 1 and 2, edition 2013, used as EAD*

Translations of this European Technical Assessment in other languages shall fully correspond to the original issued document and should be identified as such.

Communication of this European Technical Assessment, including transmission by electronic means, shall be in full (excepted the confidential Annex(es) referred to above). However, partial reproduction may be made, with the written consent of the issuing Technical Assessment Body. Any partial reproduction has to be identified as such.

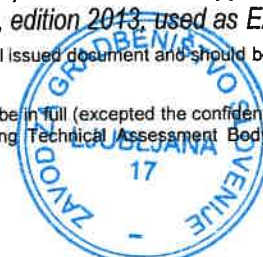

II SPECIFIC PART OF THE EUROPEAN TECHNICAL ASSESSMENT

1 Technical description of the product

The MFT EKSPANSJONBOLT SYREFAST A4 OP.1 in the range of M8, M10, M12 and M16 is an anchor made of stainless steel, which is placed into a drilled hole and anchored by torque-controlled expansion.

For the installed anchor see Figure given in Annex A1.

2 Specification and intended use

The performances given in Chapter 3 are only valid if the anchor is used in compliance with the specifications and conditions given in Annex B.

The provisions made in this European Technical Assessment are based on an assumed working life of the anchor of 50 years. The indications given on the working life cannot be interpreted as a guarantee given by the manufacturer, but are to be regarded only as a means for choosing the right products in relation to the expected economically reasonable working life of the works.

3 Performance of the product and references to the methods used for this assessment

3.1 Mechanical resistance and stability (BWR 1)

The essential characteristics for mechanical resistance and stability are listed in Annexes C1 to C4.

3.2 Safety in case of fire (BWR 2)

The essential characteristics for safety in case of fire are listed in Annex C5.

3.3 Hygiene, health and environment (BWR 3)

Regarding dangerous substances contained in this European Technical Assessment, there may be requirements applicable to the products falling within its scope (e.g. transported European legislation and national laws, regulations and administrative provisions). In order to meet provisions of the regulation (EU) No 305/2011, these requirements need also to be complied with, when they apply.

3.4 Safety in use (BWR 4)

For basic requirement safety in use the same criteria are valid as for basic requirement mechanical resistance and stability.

3.5 Protection against noise (BWR 5)

Not relevant.

3.6 Energy economy and heat retention (BWR 6)

Not relevant.

3.7 Sustainable use of natural resources (BWR 7)

No performance determined.

3.8 General aspects relating to fitness for use

Durability and serviceability are only ensured if specifications of intended use according to Annex B1 are kept.



4 Assessment and verification of constancy of performance

According to the decision 96/582/EC of the European Commission¹ the system of assessment and verification of constancy of performance (see Annex V to regulation (EU) No 305/2011) 1 apply.

5 Technical details necessary for the implementation of the AVCP system

Technical details necessary for the implementation of the AVCP system are laid down in the Control plan deposited at the Slovenian national Building and Civil Engineering Institute (ZAG).

Issued in Ljubljana on 8. 12. 2016

Signed by:

Franc Capuder, M.Sc., Research Engineer

Head of Service of TAB



¹

Official Journal of the European Communities L 254 of 8.10.1996

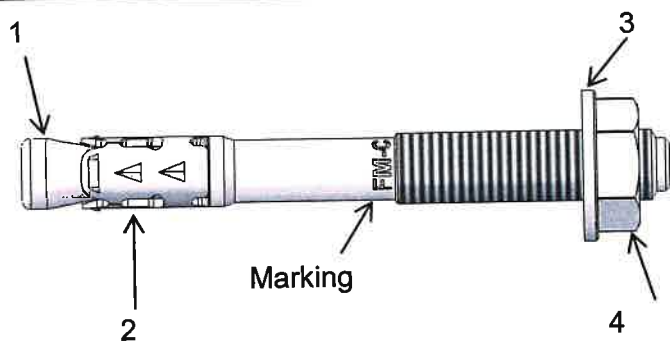

- 1 Anchor bolt (body)
- 2 Expansion sleeve
- 3 Washer
- 4 Hexagonal nut

Figure A1: MFT EKSPANSJONBOLT SYREFAST A4 OP.1 anchor

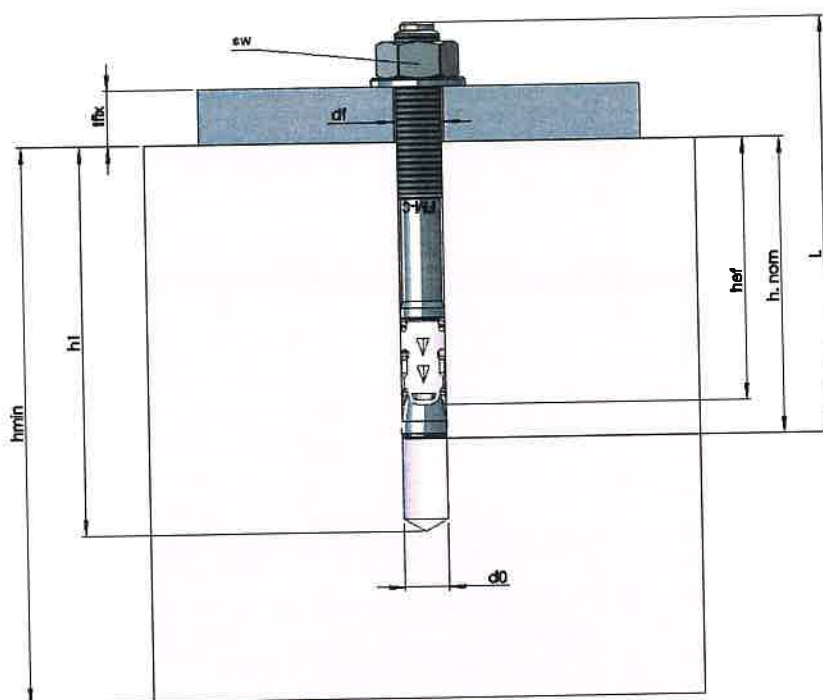

Figure A2: Installed MFT EKSPANSJONBOLT SYREFAST A4 OP.1 anchor

<p>MFT EKSPANSJONBOLT SYREFAST A4 OP.1</p>	<p>Annex A1</p>
<p>Product description</p>	
<p>Product and intended use</p>	



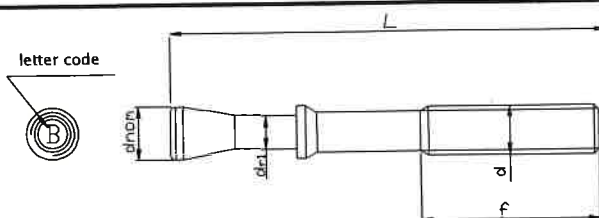

Table A1: Dimensions

	dxL	Marking	Letter code ID	L (mm)	d _{nom} (mm)	d _{r1} (mm)	f (mm)
M8	M8x68	FM-C 8/4 A4	A	68	8	5,8	30
	M8x75	FM-C 8/10 A4	B	75			30
	M8x90	FM-C 8/25 A4	C	90			40
	M8x115	FM-C 8/50 A4	D	115			60
	M8x135	FM-C 8/70 A4	E	135			80
	M8x165	FM-C 8/100 A4	G	165			80
M10	M10x90	FM-C 10/10 A4	A	90	10	7,4	40
	M10x105	FM-C 10/25 A4	B	105			55
	M10x115	FM-C 10/35 A4	C	115			55
	M10x135	FM-C 10/55 A4	D	135			85
	M10x155	FM-C 10/75 A4	E	155			85
	M10x185	FM-C 10/105 A4	F	185			85
M12	M12x110	FM-C 12/10 A4	A	110	12	8,8	65
	M12x120	FM-C 12/20 A4	B	120			65
	M12x130	FM-C 12/30 A4	P	130			65
	M12x145	FM-C 12/45 A4	C	145			85
	M12x170	FM-C 12/70 A4	D	170			85
	M12x200	FM-C 12/100 A4	E	200			85
M16	M16x130	FM-C 16/10 A4	A	130	16	11,8	65
	M16x150	FM-C 16/30 A4	B	150			85
	M16x185	FM-C 16/60 A4	C	185			85
	M16x220	FM-C 16/100 A4	D	220			85

Table A2: Materials

Part	Component	Material	Coating
1	Anchor body (bolt)	Stainless steel X2CrNiMo17-12-2 acc. to EN 10088-3 (wr. 1.4404)	
2	Expansion sleeve	Stainless steel X2CrNiMo17-12-2 acc. to EN 10088-2 (wr. 1.4404);	*
3	Washer	DIN 125/1 A4 (normal), DIN 9021 A4 (large) Stainless steel AISI 316 similar acc. to EN 10088-2	
4	Hexagonal nut	DIN 934 A4-80 Stainless Steel AISI 316 similar acc. to ISO 3506-2	*

*Functional coating

MFT EKSPANSJONBOLT SYREFAST A4 OP.1

Product description
Product and materials

Annex A2



Specifications of intended use

Anchorage subjected to:

- Static, quasi static, seismic load and fire.

Base materials:

- Cracked and non-cracked concrete.
- Reinforced and unreinforced normal weight concrete of strength class C20/25 at minimum and C50/60 at maximum according to EN 206-1:2000/A2:2005.

Use conditions (Environmental conditions):

- The anchor may be used in concrete subject to dry internal conditions and also in concrete subject to external atmospheric exposure (including industrial and marine environment), or exposure in permanent damp internal conditions, if no particular aggressive conditions exist.

Note: Particular aggressive conditions are e.g. permanent, alternating immersion in seawater or splash zone of seawater, chloride atmosphere of indoor swimming pools or atmosphere with extreme chemical pollution (e.g. desulphurization plants or road tunnels where de-icing materials are used)

Design:

- Anchorages are designed under the responsibility of an engineer experienced in anchorages and concrete work.
- Anchorages under static and quasi-static actions are designed in accordance with ETAG 001, Annex C, design method A, Edition August 2010 or CEN/TS 1992-4-4.
- For seismic application the anchorages are designed in accordance with TR 045 "Design of metal anchors for use in concrete under seismic actions".
- For application with resistance under fire exposure the anchorages are designed in accordance with method given in TR 020 "Evaluation of anchorage in concrete concerning resistance to fire".
- Verifiable calculation notes and drawings are prepared taking into account of the load to be anchored. The position of the anchor is indicated on the design drawings (e.g. position of the anchor relative to reinforcement or to supports, etc.).

Installation:

- Anchor installation carried out by appropriately qualified personnel and under supervision of the person responsible for technical matters of the site.
- Use of the anchor only supplied by the manufacturer without exchanging the components of an anchor.
- Anchor installation in accordance with the manufacturer's specification and drawings and using the appropriate tools.
- Checks before placing the anchor to ensure that the strength class of the concrete in which the anchor is to be placed is in the range given and is not lower than that of the concrete to which the characteristic loads apply for.
- Check of concrete being well compacted, e.g. without significant voids.
- Effective anchorage depth, edge distances and spacing not less than the specified values without minus tolerances.
- Hole drilling by hammer drill.
- Cleaning of the hole of drilling dust.
- Positioning of the drill holes without damaging the reinforcement.
- Application of specified torque moment using a calibrated torque wrench.
- In case of aborted hole, drilling of new hole at a minimum distance of twice the depth of the aborted hole, or smaller distance provided the aborted drill hole is filled with high strength mortar and no shear or oblique tension loads in the direction of aborted hole.

MFT EKSPANSJONBOLT SYREFAST A4 OP.1	
Intended use Specification	<p style="text-align: center;">Annex B1</p> 

Table B1: Installation data

	dxL	ID	t _{fix} [mm]	d ₀ [mm]	h ₁ [mm]	h _{nom} [mm]	h _{ef} [mm]	d _f [mm]	h _{min} [mm]	T _{inst} [Nm]	sw [mm]	Marking
M8	M8x68	A	4	8	70	54	48	9	100	20	13	FM-C 8/4 A4
	M8x75	B	10									FM-C 8/10 A4
	M8x90	C	25									FM-C 8/25 A4
	M8x115	D	50									FM-C 8/50 A4
	M8x135	E	70									FM-C 8/70 A4
	M8x165	G	100									FM-C 8/100 A4
M10	M10x90	A	10	10	80	67	60	12	120	40	17	FM-C 10/10 A4
	M10x105	B	25									FM-C 10/25 A4
	M10x115	C	35									FM-C 10/35 A4
	M10x135	D	55									FM-C 10/55 A4
	M10x155	E	75									FM-C 10/75 A4
	M10x185	F	105									FM-C 10/105 A4
M12	M12x110	A	10	12	100	81	72	14	150	60	19	FM-C 12/10 A4
	M12x120	B	20									FM-C 12/20 A4
	M12x130	P	30									FM-C 12/30 A4
	M12x145	C	45									FM-C 12/45 A4
	M12x170	D	70									FM-C 12/70 A4
	M12x200	E	100									FM-C 12/100 A4
M16	M16x130	A	10	16	115	97	86	18	170	120	24	FM-C 16/10 A4
	M16x150	B	30									FM-C 16/30 A4
	M16x185	C	60									FM-C 16/60 A4
	M16x220	D	100									FM-C 16/100 A4

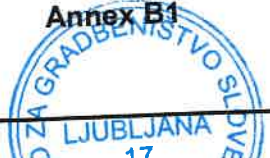
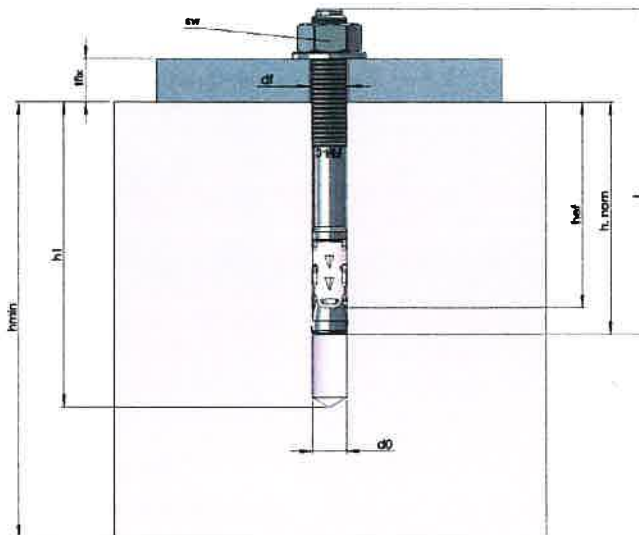

MFT EKSPANSJONBOLT SYREFAST A4 OP.1

Intended use

Installation data

Annex B2



Table C1: Characteristic values for Tension loads in case of static and quasi-static loading for design method A acc. ETAG 001-Annex C or CEN/TS1992-4-4

Essential characteristics		Performance				
		M8	M10	M12	M16	
Installation parameters						
d_0	Nominal diameter of drill bit	[mm]	8	10	12	16
h_{nom}	Anchorage depth	[mm]	54	67	81	97
h_{ef}	Effective anchorage depth	[mm]	48	60	72	86
h_{min}	Minimum thickness of concrete member	[mm]	100	120	150	170
T_{inst}	Torque moment	[Nm]	20	40	60	120
s_{min}	Minimum spacing	[mm]	50	55	60	70
for $c \geq$	Edge distance	[mm]	50	70	80	100
c_{min}	Minimum edge distance	[mm]	50	50	60	70
for $s \geq$	Spacing	[mm]	50	110	120	130
Tension steel failure mode						
$N_{Rk,s}$	Characteristic tension steel failure	[kN]	21	34	49	88
γ_{MsN}	Partial safety factor	[-]	1,5			
Pull-out failure mode						
$N_{Rk,p}$	Characteristic pull-out failure in non-cracked concrete	[kN]	9	16	20	35
$N_{Rk,p}$	Characteristic pull-out failure in cracked concrete	[kN]	5	9	12	25
γ_2	Partial safety factor	[-]	1,0			
γ_{Mp}	Partial safety factor	[-]	1,5			
$s_{cr,N}$	Characteristic spacing	[mm]	3 x h_{ef}			
$c_{cr,N}$	Characteristic edge distance	[mm]	1,5 x h_{ef}			
ψ_c C30/37	Increasing factor for $N_{Rk,p}$ in non-cracked concrete	[-]	1,22			
ψ_c C40/50		[-]	1,41			
ψ_c C50/60		[-]	1,55			
Concrete Cone failure mode						
k_{cr}	Factor for cracked concrete CEN/TS 1992-4-4 §. 6.2.1.4	[-]	7,2			
k_{ucr}	Factor for un-cracked concrete CEN/TS 1992-4-4 §. 6.2.1.4	[-]	10,1			
γ_{Mc}	Partial safety factor	[-]	1,5			
Splitting failure mode						
$s_{cr,sp}$	Characteristic spacing	[mm]	3 x h_{ef}			
$c_{cr,sp}$	Characteristic edge distance	[mm]	1,5 x h_{ef}			
γ_{Msp}	Partial safety factor	[-]	1,5			
Displacement under tension load						
Non-cracked concrete C20/25						
N	Service tension load	[kN]	4,3	7,6	9,5	16,7
δ_{N0}	Short term displacement	[mm]	0,3	0,4	0,4	0,3
$\delta_{N_{\infty}}$	Long term displacement	[mm]	1,4	1,5	0,9	1,4
Cracked concrete C20/25						
N	Service tension load	[kN]	2,4	4,3	5,7	11,9
δ_{N0}	Short term displacement	[mm]	0,7	0,6	0,7	0,7
$\delta_{N_{\infty}}$	Long term displacement	[mm]	1,4	1,5	0,9	1,4

¹⁾ The pull-out is not decisive

MFT EKSPANSJONBOLT SYREFAST A4 OP.1

Design acc. to ETAG 001-Annex C or CEN/TS 1992-4-4

Characteristic resistance under Tension loads – BWR 1

Annex C1



Table C2: **Characteristic values for Shear loads in case of static and quasi-static loading for design method A acc. ETAG 001-Annex C or CEN/TS 1992-4-4**

Essential characteristics			Performance			
			M8	M10	M12	M16
Shear steel failure						
$V_{Rk,s}$	Characteristic shear steel failure	[kN]	11,9	18,8	27,4	51,0
$M^0_{Rk,s}$	Bending moment characteristic failure	[Nm]	24	49	85	216
γ_{MsV}	Partial safety factor	[-]	1,3			
K_2	Factor considering ductility	[-]	0,8			
Shear concrete pry-out and edge failure						
K	Factor in equation (5.6) of ETAG 001 Annex C § 5.2.3.3	[mm]	1,0	2,0		
K_3	Factor in equation (16) of CEN/TS 1992-4-4 § 6.2.2.3	[mm]	1,0	2,0		
l_{ef}	Effective anchorage depth	[mm]	48	60	72	86
d_{nom}	Diameter of anchor	[mm]	8	10	12	16
γ_{Mc}	Partial safety factor	[-]	1,5			
Displacement under shear load						
V	Service shear load	[kN]	6,5	10,4	15,1	28,0
δ_{v0}	Short term displacement	[mm]	0,8	0,9	1,2	2,5
$\delta_{v\infty}$	Long term displacement	[mm]	1,3	1,3	1,8	3,8

MFT EKSPANSJONBOLT SYREFAST A4 OP.1

Design acc. to ETAG 001-Annex C or CEN/TS 1992-4-4
 Characteristic resistance under Shear loads – BWR 1

Annex C2



Table C3: Characteristic values for resistance in case of Seismic performance category C1 acc. TR 045 "Design of Metal anchor under Seismic Actions"

Essential characteristics			Performance			
			M8	M10	M12	M16
Tension steel failure						
$N_{Rk,s,seis\ C1}$	Characteristic tension steel failure	[kN]	21	34	49	88
$\gamma_{MsN,seis}^{1)}$	Partial safety factor	[-]	1,5			
Pull-out failure mode $N_{Rk,p,seis} = \psi_C \times N_{Rk,p,seis}^0$						
$N_{Rk,p,seis\ C1}$	Characteristic pull-out failure in concrete C20/25	[kN]	4,1	9,0	12,0	25,0
$\gamma_{Mp,seis}^{1)}$	Partial safety factor	[-]	1,5			
Shear steel failure						
$V_{Rk,s,seis\ C1}$	Characteristic shear steel failure	[kN]	8,0	12,3	15,8	36,6
$\gamma_{MsV,seis}^{1)}$	Partial safety factor	[-]	1,3			

¹⁾ The recommended partial safety factors under seismic action ($\gamma_{M,seis}$) are the same as for static loading

MFT EKSPANSJONBOLT SYREFAST A4 OP.1

Design according to TR 045
Characteristic resistance under Seismic actions – BWR 1

Annex C3



Table C4: Characteristic values for resistance in case of Seismic performance category C2 acc. TR 045 "Design of Metal anchor under Seismic Actions"

Essential characteristics			Performance			
			M8	M10	M12	M16
Tension steel failure						
$N_{Rk,s,seis} C2^{2)}$	Characteristic tension steel failure	[kN]	21	34	49	88
$\gamma_{Ms}^{3)}$	Partial safety factor	[-]	1,5			
Pull-out failure $N_{Rk,p,seis} = \psi_C \times N_{Rk,seis}^0$						
$N_{Rk,s,seis} C2^{2)}$	Characteristic pull-out failure in concrete C20/25	[kN]	-	2,4	8,8	21,9
$\gamma_{Mp}^{3)}$	Partial safety factor	[-]	1,5			
$\delta_{N,sei(DLS)}^{1)2)}$	Displacement at DLS	[mm]	-	2,9	4,9	6,3
$\delta_{N,sei(ULS)}^{1)2)}$	Displacement at ULS	[mm]	-	15,8	15,7	21,0
Shear steel failure						
$V_{Rk,s,seis} C2^{2)}$	Characteristic shear failure	[kN]	-	12,3	15,8	36,6
$\gamma_{MsV}^{3)}$	Partial safety factor	[-]	1,3			
$\delta_{V,sei(DLS)}^{1)2)}$	Displacement at DLS	[mm]	-	2,4	5,2	6,0
$\delta_{V,sei(ULS)}^{1)2)}$	Displacement at ULS	[mm]	-	4,1	9,7	10,7

1) The listed displacement represent mean values

2) A smaller displacement may be required in the design in the case of displacement sensitive fastenings or "rigid" supports. The characteristic resistance associated with such smaller displacement may be determined by linear interpolation or proportional reduction.

3) The recommended partial safety factors under seismic action ($\gamma_{M,seis}$) are the same as for static loading

MFT EKSPANSJONBOLT SYREFAST A4 OP.1

Design according to TR 045
Characteristic resistance under Seismic actions - BWR 1

Annex C4

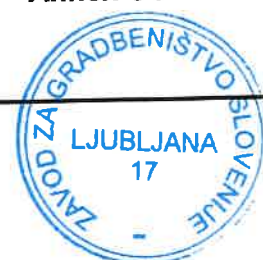

Table C5: Characteristic resistance under Fire exposure for design acc. to TR 020

Essential characteristics			Performance			
			M8	M10	M12	M16
Tension steel failure mode						
$FR_{k,s,fi,30}$	Duration = 30 minutes	[kN]	0,5	1,1	1,8	3,3
$FR_{k,s,fi,60}$	Duration = 60 minutes	[kN]	0,4	0,9	1,5	2,7
$FR_{k,s,fi,90}$	Duration = 90 minutes	[kN]	0,3	0,7	1,2	2,2
$FR_{k,s,fi,120}$	Duration = 120 minutes	[kN]	0,3	0,6	1,0	1,8
Pull-out failure mode						
$FR_{k,p,fi,30}$	Duration = 30 minutes	[kN]	1,3	2,3	3,0	6,3
$FR_{k,p,fi,60}$	Duration = 60 minutes	[kN]	1,3	2,3	3,0	6,3
$FR_{k,p,fi,90}$	Duration = 90 minutes	[kN]	1,3	2,3	3,0	6,3
$FR_{k,p,fi,120}$	Duration = 120 minutes	[kN]	1,0	1,8	2,4	5,0
Concrete cone failure mode						
$FR_{k,c,fi,30}$	Duration = 30 minutes	[kN]	2,9	5,0	7,9	12,3
$FR_{k,c,fi,60}$	Duration = 60 minutes	[kN]	2,9	5,0	7,9	12,3
$FR_{k,c,fi,90}$	Duration = 90 minutes	[kN]	2,9	5,0	7,9	12,3
$FR_{k,c,fi,120}$	Duration = 120 minutes	[kN]	2,3	4,0	6,3	9,9
$s_{cr,N}$	Characteristic spacing	[mm]	4 x h_{ef}			
$c_{cr,N}$	Characteristic edge distance	[mm]	2 x h_{ef}			
s_{min}	Minimum spacing	[mm]	50	50	60	70
c_{min}	Minimum edge distance	[mm]	$c_{min} = 2 h_{ef}$; if fire attack from more than one side, the edge distance of the anchor has to be $\geq 300\text{mm}$ and $\geq 2 h_{ef}$			
$\gamma_{M,fi}$	Partial safety factor	[-]	1,0 ¹⁾			
Shear steel failure without lever arm						
$VR_{k,s,fi,30}$	Duration = 30 minutes	[kN]	0,7	1,5	2,5	4,7
$VR_{k,s,fi,60}$	Duration = 60 minutes	[kN]	0,6	1,2	2,1	3,9
$VR_{k,s,fi,90}$	Duration = 90 minutes	[kN]	0,4	0,9	1,7	3,1
$VR_{k,s,fi,120}$	Duration = 120 minutes	[kN]	0,4	0,8	1,4	2,5
Shear steel failure with lever arm						
$M^0_{VR_{k,s,fi,30}}$	Duration = 30 minutes	[Nm]	0,7	1,9	3,9	10,0
$M^0_{VR_{k,s,fi,60}}$	Duration = 60 minutes	[Nm]	0,6	1,5	3,3	8,3
$M^0_{VR_{k,s,fi,90}}$	Duration = 90 minutes	[Nm]	0,4	1,2	2,6	6,7
$M^0_{VR_{k,s,fi,120}}$	Duration = 120 minutes	[Nm]	0,4	1,0	2,1	5,3
Shear concrete pry-out failure						
k	Factor in equation (5.6) of ETAG Annex C § 5.2.3.3	[mm]	1,0	2,0		
Shear concrete edge failure						
The characteristic resistance $V^0_{Rk,c,fi}$ in C 20/25 to C5 0/60 concrete is determined by: $V^0_{Rk,c,fi} = 0,25 \times V^0_{Rk,c} (\leq R90)$ and $V^0_{Rk,c,fi} = 0,20 \times V^0_{Rk,c} (R120)$ with $V^0_{Rk,c}$ initial value of the characteristic resistance in cracked concrete C20/25 under normal temperature acc. ETAG 001, Annex C, 5.2.3.4.						

¹⁾ In absence of other national regulations

MFT EKSPANSJONBOLT SYREFAST A4 OP.1

Design according to TR 020
Characteristic resistance under Fire exposure - BWR 2

Annex C5

